



Tweco[®]
Robotics

Fixed Automation Arc Welding Equipment and Consumables

CATALOG

www.tweco.com

- ***Superior Reliability***
- ***Superior Repeatability***

Welcome to the new Tweco® Robotics Fixed Automation catalog!

We here at Thermadyne are very excited to offer you incredible choice and innovation in Fixed Automation MIG welding equipment.

Our engineers have been listening to you and have provided a great selection of well designed products, competitively priced with the features and value you expect from Tweco Robotics. We would like to direct your attention to some of the products contained in this new catalog that you will find exciting.

Check out the following:

- QF Series Automated MIG gun and cable assemblies...based on our popular and proven QR Series products! Robotics styled conductor tubes machined to the tightest tolerances for the ultimate in repeatability.
- The QF Series MIG guns are offered in air and water cooled configurations to meet all of your most demanding applications.
- Check out more standard features on the QF Series like heavy duty cable supports front and rear, quick hose connections and more on page 10!
- Inside you will find complete product information on our line of QR and TAM Series torch and cable assemblies along with consumable parts breakdowns, complete conductor tube selections and accessories.
- Beginning on page 44 you will find our line up of innovative fixed automation water cooled nozzle assemblies and submerged arc nozzle assemblies.
- WRS Series 400 amp and 600 amp Direct Plug Series of water cooled MIG guns with complete consumable and accessory breakdowns.
- Tweco Robotics also offers a full line up of automated MIG work station accessories. Including fixturing, anti-spatter kits and water coolers

Tweco Robotics is your total automated MIG supplier. Tweco has long been the industry leader in MIG gun technology offering strength through innovation. We thank your for reviewing our new Fixed Automation catalog and look forward to bringing you more great innovative products in the future.

Thank you for considering Tweco Robotics for your Fixed Automation requirements.

Table Of Contents

	Page
Introduction	
Tweco® Robotics Fixed Automation MIG Guns QF Series, TAM Series, RA Series, and WRS Series	4 - 5
QF Series Air-Cooled & Water-Cooled – 600 Ampere QF Series Direct Plug and Torch Body with Cable Assemblies, Conductor Tubes, and Replacement Consumables (Diffusers and Nozzles)	6 - 24
TAM Series Air-Cooled – 400 & 500 Ampere Tam Series Direct Plug and Torch Body With Cable Assemblies and TAM-RAK	25 - 29
RA Series Air-Cooled – 400 & 600 Ampere RA Series Torch Body With Cable Assemblies and Conductor Tubes	30 - 32
Nozzles For TAM & RA Series Air-Cooled MIG Guns	33 - 43
Water-cooled Nozzle Assembly For TAM & RA Series MIG Gun	44
Submerged-Arc Nozzle Assembly	45
Gas Diffusers For TAM & RA Series MIG Gun	46
WRS Series Water-Cooled – 400 & 600 Ampere WRS Series Direct Plug and Torch Body With Cable Assemblies, Conductor Tubes, and Replacement Consumables	47 - 56
Contact Tips Standard, Heavy-Duty, Silver Copper, and Chrome Zirconium	57 - 62
Conduit Liners	63 - 64
TJ-2 “Tri-Just” Holding Fixture	65 - 69
QRM-100 Anti-Spatter Mist Applicator	70 - 71
Water-Coolers	72 - 73

Tweco® Robotics Automation Products

Tweco Robotics offers a complete line of automation MIG guns with or without cable assemblies. The product line consists of both air-cooled and water-cooled MIG guns and cable assemblies.

QF — TAM — RA — WRS

Each series offers something different that will meet your specific MIG fixed automation welding application specifications.



QF Series

This series of Automation MIG guns is offered with and without cable assemblies. The series incorporates some of the same features found on the Tweco Robotics QR series MIG gun assemblies. Offered for use in MIG air-cooled and water-cooled welding applications.

Welding applications using the air-cooled QF series torches can take advantage of the eight different bend configurations of air-cooled QTR66 conductor tubes. Welding applications requiring the water-cooled QF series torches utilizes the water-cooled QTRW series conductor tubes, which are available in three different amperage ranges (300, 400, and 600), and eight different degrees of bend configurations.

Refer to Pages 6 through 24 for more detail.

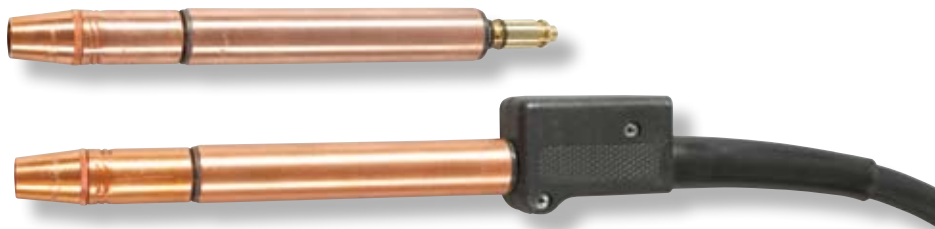

TAM Series

This series of Automation MIG guns is offered with and without a cable assembly. The series is only offered for air-cooled welding applications. There are two amperage ranges available, 400 and 500 ampere @ 60% duty cycle, both are offered with and without a cable assembly.

Mounting of this particular series is directly to the 1-1/8" (28.58mm) outside diameter of the torch barrel. The outer surface of the torch body is insulated from the inner tube by a polyester molding compound providing excellent di-electric properties.

TAM series with cable assemblies are offered in lengths of 2ft. (.61m) to 15ft. (5m).

Refer to Pages 25 through 29 for more detail.



RA Series

This series of Automation MIG guns are offered only with a cable assembly and strictly for air-cooled welding applications. There are two amperage ranges to choose from, 400 and 600 ampere @ 60% duty cycle. Mounting surface is the outer diameter of the 1-5/8" (41,28mm) plastic case.

Five different bend configuration conductor tubes are available to choose from in each amperage range. The conductor tubes are keyed into the brass body of the assembly allowing a conductor tube to be replaced and the adjustments to be minimal when going from one tube configuration to another.

Refer to Pages 30 through 32 for more detail.

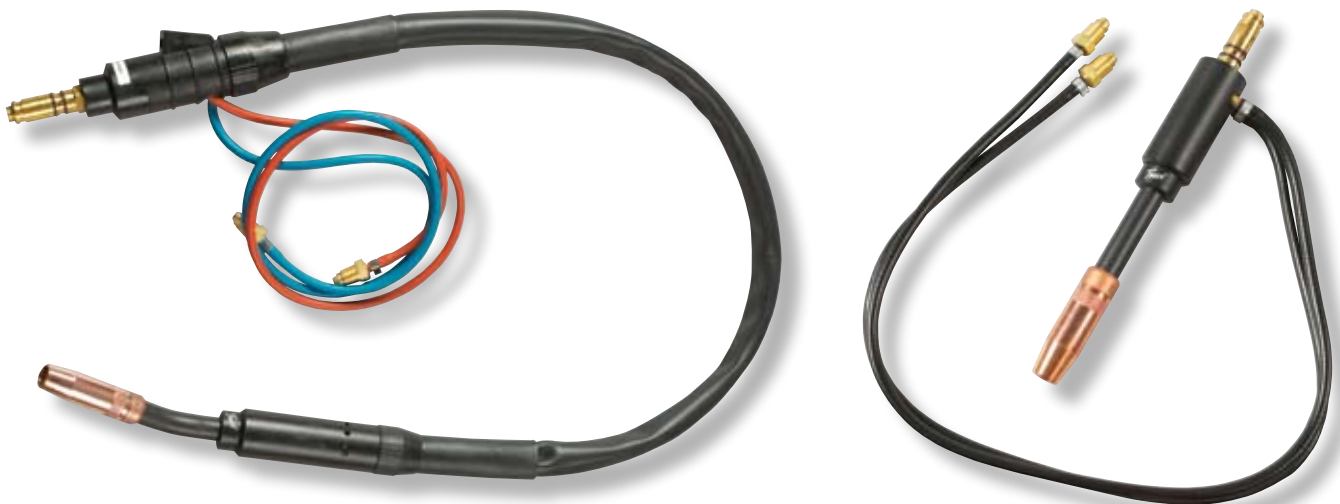

WRS Series

This series of Automation MIG guns are offered with and without a cable assembly and strictly for water-cooled welding applications. There are two amperage ranges to choose from, 400 and 600 ampere @ 100% duty cycle. Mounting surface is the outer diameter of the 1-5/8" (41,28mm) plastic case.

Eight different bend configuration conductor tubes are available to choose from for each amperage range. The conductor tubes are keyed into the brass body of the assembly allowing the conductor tube to be replaced and the adjustments to be minimal when going from one tube to another.

Refer to Pages 47 through 56 for more detail.

Air-cooled Direct Plug Automation Torch Body



QFA600
(Stock No. 3045-1489)

The air-cooled QFA torch body is rated at 600 amperes at 60% duty cycle and can weld with wire diameters from .030" to 1/8". This style of torch is used when the wire feeder and work piece can be in close proximity to each other and the assembly being welded can rotate or be moved under the conductor tube.

There are no power cables to deal with, simply plug the assembly into any wire feeder and be welding in no time. The series will accept the Tweco® Robotics QTR66 series conductor tubes, which are constructed to be both extremely rigid and reliable. The inner tube is machined from an extruded copper tube providing excellent electrical conductivity for cool operation even under high amperage applications. The outer jacket is made from a seamless 3/4" outside diameter (OD) stainless steel tube that is insulated from the inner tube by a teflon sleeve providing excellent di-electric properties.

The conductor tubes are positively located into the torch body by the use of two stainless steel alignment pins. These pins ensure the proper relationship with the torch body and fixture mount. The back end of the conductor tube is made from a solid brass connection with a stainless steel alloy wear surface in the area where the tube is drawn and locked in place inside of the torch block. An O-ring seal prevents the shielding gas from escaping and seals against atmospheric air contamination.

Standard Features:

- Quick Tube locking
- Conductor tubes are positively located into the torch body
- Purge hose for spraying Protex® anti-spatter compound through the conductor tube and nozzle
- Furnished with R45-116 conduit
- Furnished with Tweco®, Miller®, and Lincoln® rear connector plug

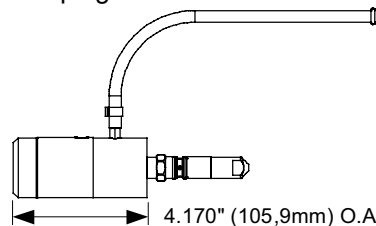

QTR Series 600 amp Air-cooled Robotic Conductor Tube

	18°	22°	45°	60°	180°	22°L	45°L	180°L
Part No.	QTR66-18	QTR66-22	QTR66-45	QTR66-60	QTR66-180	QTR66-22L	QTR66-45L	QTR66-180L
Stock No.	1686-1840	1686-1841	1686-1842	1686-1843	1686-1844	1686-1845	1686-1847	1686-1846

Note: Refer to page 17 for information pertaining to the air-cooled conductor tubes.

Miller is a registered trademark of Illinois Tool Works, Inc. Lincoln is a registered trademark of Lincoln Electric Co. The afore mentioned registered trademarks are in no way affiliated with Tweco Robotics or Thermadyne Industries, Inc. Tweco is a registered trademark of Thermadyne Industries, Inc.

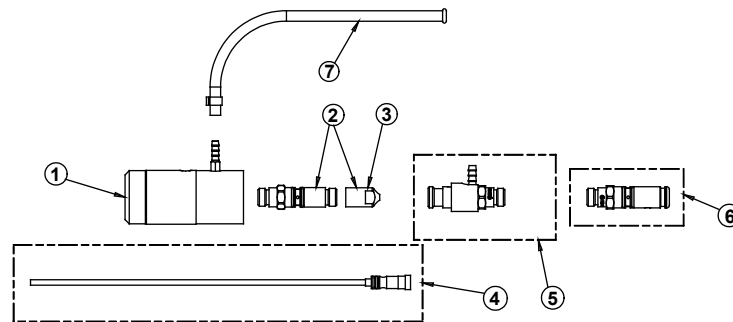

QFA600 AIR-COOLED TORCH

ITEM NO.	PART NO.	STOCK NO.	DESCRIPTION
1	QFA600BC	3045-1154	Air-cooled Block Cartridge
2	R176MH	2060-2184	Miller® Connector Plug (Includes Item #3) ***
	R174MH	2035-2109	Miller Connector Plug (Includes Item #3)
3	R175M-N045	2050-2181	Miller Plug Nipple, .045" (1,0mm) Wire Use with R176MH
	R174M-N045	2040-2192	Miller Plug Nipple, .045" (1,0mm) Wire Use with R174MH
	R175M-N116	2050-2182	Miller Plug Nipple, .062" (1,6mm) Wire Use with R176MH
	R174M-N116	2040-2191	Miller Plug Nipple, .062" (1,6mm) Wire Use with R174MH
NS	R175MN18	2050-2183	Miller Plug Nipple, .125" (3,18mm)
4	R45-3545-1	1450-1023	R45 Series Conduit Liner
	R45-116-1	1450-1028	R45 Series Conduit Liner ***
	R44-3545-1	1440-1223	R44 Series Conduit Liner
	R44-116-1	1440-1228	R44 Series Conduit Liner
5	QTR176LH	2086-2624	Lincoln® Connector Plug (2.71" – 68,83mm OAL) ***
	EL176LH	2060-2680	Lincoln Connector Plug (3.84" – 97,54mm OAL)
	QTR174LH	2086-2623	Lincoln Connector Plug (Uses R44 Series Conduit)
6	176S-H	2060-2177	Tweco® Connector Plug ***
	350-174H	2035-2110	Tweco Connector Plug (Uses R44 Series Conduit)
7	QF600PH	3045-1246	Purge Hose Assembly (Includes Hose Clamp)

*** — Standard on all QFA Series Torch Body Assembly

Tweco Robotics offers a complete line of nozzles, diffusers, and contact tips.

Robotic Style Nozzles (REL & RWC Series)

All nozzles are machined from solid copper bar stock that assures consistent dimensional stability and an efficient dissipation of heat. The nozzles are nickel-plated and are insulated to act as a barrier for the spatter bridging between the nozzle and gas diffuser.

Robotic Diffusers

All of the diffusers are machined from a brass alloy and contain twelve gas holes for better distribution of the shielding gas. There are diffusers for both the threaded and cam style contact tips.

Robotic Contact Tips (RS & RZ Series)

Robotic contact tips are offered in two different materials that provide better performance versus the pure copper contact tips used on the hand-held MIG guns. The RS series are machined from a copper-silver material that has better conductivity - resistance properties, reducing the micro arcing on the inside diameter that occurs

Miller is a registered trademark of Illinois Tool Works, Inc. Lincoln is a registered trademark of Lincoln Electric Co. The afore mentioned registered trademarks are in no way affiliated with Tweco Robotics or Thermadyne Industries, Inc. Tweco is a registered trademark of Thermadyne Industries, Inc.

Water-Cooled Direct Plug Automation Torch Body



QFW600 (Stock No. 3045-1674)

The water-cooled QFW torch body is rated at 600 amperes at 100% duty cycle and can weld with wire diameters from .030" to 1/8". This style of torch is used when the wire feeder and work piece can be in close proximity to each other and the assembly being welded can rotate or be moved under the conductor tube.

There are no power cables to deal with, simply plug the assembly into any wire feeder, connect the inlet and outlet water hoses to a water-cooler and begin welding in no time. The series will accept the Tweco® Robotics QTRW63, QTRW64, and QTRW66 series conductor tubes, which are constructed to be both extremely rigid and reliable. The torch body uses QTRW63, 64, and 66 series conductor tubes that are offered in a variety of bend configurations to meet your robotic welding application requirements. The QTRW series conductor tubes are sold separately.

Water shut-off valves located in the torch body allow the removal of the conductor tube without shutting off the water supply. This reduces the chance of introducing moisture into the conductor tube and conduit.

The conductor tubes are positively located into the torch body by the use of two stainless steel alignment pins. These pins ensure the proper relationship with the torch body and fixture mount. The back end of the conductor tube is made from a stainless steel alloy providing an excellent wear surface in the area where the tube is drawn and locked in place inside of the torch block.

Standard Features:

- Quick Tube locking
- Conductor tubes are positively located into the torch body
- Purge Hose for spraying Protex® anti-spatter compound through the conductor tube and nozzle
- Furnished with R45-116 Conduit
- Furnished with Tweco®, Miller®, and Lincoln® rear connector plug
- Water hose quick connections

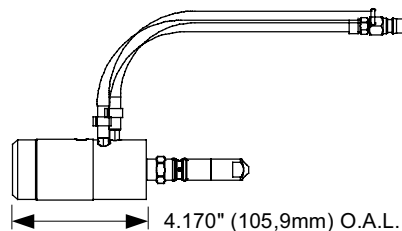

Miller is a registered trademark of Illinois Tool Works, Inc. Lincoln is a registered trademark of Lincoln Electric Co. The afore mentioned registered trademarks are in no way affiliated with Tweco Robotics or Thermadyne Industries, Inc. Tweco is a registered trademark of Thermadyne Industries, Inc.

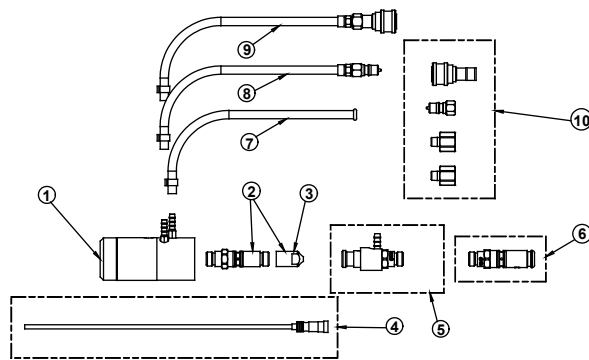

QFW600 WATER-COOLED TORCH

Item No.	Part No.	Stock No.	Description
1	QFW600BC	3045-1346	Water-cooled Block Cartridge
2	R176MH	2060-2184	Miller® Connector Plug (Includes Item #3) ***
	R174MH	2035-2109	Miller Connector Plug (Includes Item #3)
3	R175M-N045	2050-2181	Miller Plug Nipple, .045" (1,0mm) Wire Use with R176MH
	R174M-N045	2040-2192	Miller Plug Nipple, .045" (1,0mm) Wire Use with R174MH
	R175M-N116	2050-2182	Miller Plug Nipple, .062" (1,6mm) Wire Use with R176MH
	R174M-N116	2040-2191	Miller Plug Nipple, .062" (1,6mm) Wire Use with R174MH
4	R45-3545-1	1450-1023	R45 Series Conduit Liner
	R45-116-1	1450-1028	R45 Series Conduit Liner ***
	R44-3545-1	1440-1223	R44 Series Conduit Liner
	R44-116-1	1440-1228	R44 Series Conduit Liner
NS	R175MN18	2050-2183	Miller Plug Nipple, .125" (3,18mm)
5	QTR176LH	2086-2624	Lincoln® Connector Plug (2.71" – 68,83mm OAL) ***
	EL176LH	2060-2680	Lincoln Connector Plug (3.84" – 97,54mm OAL)
	QTR174LH	2086-2623	Lincoln Connector Plug (Uses R44 Series Conduit)
6	176S-H	2060-2177	Tweco® Connector Plug ***
	350-174H	2035-2110	Tweco Connector Plug (Uses R44 Series Conduit)
7	QF600PH	3045-1246	Purge Hose Assembly (Includes Hose Clamp)
8	QFW600-WO	3045-1324	Water Hose – OUT (Includes Hose Clamp)
9	QFW600-WI	3045-1323	Water Hose – IN (Includes Hose Clamp)
10	400LK-QC	2044-2000	Quick Connector Male & Female

*** — Standard on all QFW Series Torch Body Assembly

Consider a water cooler unit from Tweco Products to enhance your water-cooled MIG welding process.

- Vertical or horizontal models available.
- Designed for MIG guns up to 800 amps and TIG torches up to 500 amps.
- Stainless steel construction eliminates coolant contamination due to electrolyte and chemical reactions.
- High efficiency radiator design pulls outside air through radiator.
- Available with either gear or vane pumps.
- Pump by-pass to tank on rotary gear pump – keeps pump from overheating.
- Vance pumps are equipped with a bypass to eliminate excessive pump wear.

Part No.	Stock No.	Description
TC900-G	4010-1010	Cooler w/ Gear Pump – Horizontal – 110V 50/60 Hz.
TC900-V	4010-1011	Cooler w/ Vane Pump – Horizontal – 110V 50/60 Hz.
TC900-GX	4010-1012	Cooler w/ Vane Pump – Horizontal – 230V 50/60 Hz.
TCV900-G	4010-1035	Cooler w/ Gear Pump – Vertical – 110V 50/60 Hz.
TCV900-V	4010-1036	Cooler w/ Vane Pump – Vertical – 110V 50/60 Hz.

Miller is a registered trademark of Illinois Tool Works, Inc. Lincoln is a registered trademark of Lincoln Electric Co. The afore mentioned registered trademarks are in no way affiliated with Tweco Robotics or Thermadyne Industries, Inc. Tweco is a registered trademark of Thermadyne Industries, Inc.

QF Series Automation Gun and Cable Assembly

Tweco® Robotics offers a new automated MIG gun series designed for use in air-cooled and water-cooled welding applications. This new series will provide superior reliability and repeatability which results in less downtime and increased output in your automated weld cell.

QF (Quick Fixed) Series Automated MIG Gun and Cable Assembly

QFA (air-cooled) assembly is rated for 600 amperes at 60% duty cycle and can weld with wire diameters from .030" to 1/8". Uses the QTR66 series conductor tubes offered in various degrees of bend configurations. The QTR66 series conductor tubes are sold separately.

QFW (water-cooled) assembly is rated for 600 amperes at 80% duty cycle and can weld with wire diameters from .030" to 1/8". Uses QTRW63, 64, and 66 series conductor tubes that are offered in a variety of bend configurations to meet your fixed automation welding application requirements. The QTRW series conductor tubes are sold separately.

Benefits:

- Engineered to withstand the high duty cycles required for automated weld cells.
- Quick change locking screw for securing the conductor tube in place. Takes only seconds not minutes to change out a conductor tube assembly.
- Insulated mounting surface with keyed front cartridge assembly — to ensure repeatability.
- Uses robotic style conductor tubes, which are machined and assembled to the tightest tolerances for repeatability and accuracy.

Standard Features:

- Offered in lengths – 4 ft (91cm) – 15 ft. (5 m)
- Furnished with the standard 1-5/8" (41,28mm) diameter-mounting surface.
- Mounting surface consists of a torch block and sleeve combination — referred to as the cartridge kit — assembled individually, positioned and pinned in place to ensure repeatability and accuracy.
- Conductor tubes are positively located into the torch body by the use of two (2) stainless steel alignment pins. Pins ensure the proper relationship with the torch body and fixture mount.
- Inner cable protective jacket.
- Heavy cable support springs on both front and rear.
- Kevlar®/Nylon outer protective cable cover.
- Water-cooled cable has built in water shut-off valves in the front housing.
- Quick hose connections on all water-cooled cables.
- Internal purge hose for spraying anti-spatter through the conductor tube and nozzle.
- Furnished with R45-116 conduit.
- Furnished with Tweco®, Miller®, and Lincoln® rear connector plug.

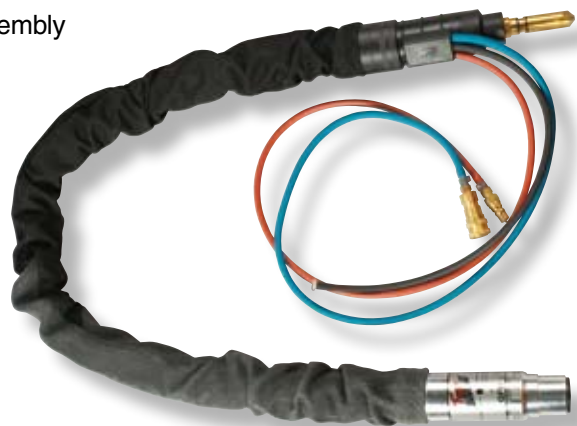

Miller is a registered trademark of Illinois Tool Works, Inc. Lincoln is a registered trademark of Lincoln Electric Co. The afore mentioned registered trademarks are in no way affiliated with Tweco Robotics or Thermadyne Industries, Inc. Tweco is a registered trademark of Thermadyne Industries, Inc.

QFA Series Air-cooled Automation Gun and Cable Assembly

Additional Feature:

A Cablehoz comprised of three primary components:

- The outer jacket is a tear-resistant, radiation cross-linked polymer extruded over the copper stranding.
- The copper is spun around a hytel center core tube, providing flexibility and support for the inner core.
- The inner core acts as the shielding gas carrier as well as support for the wire conduit assembly.

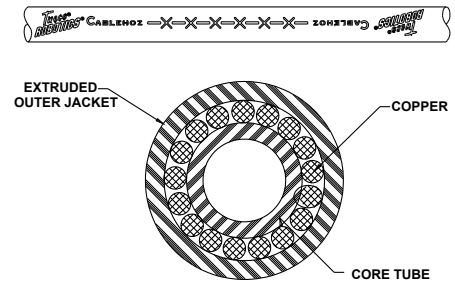

QFA Series 600 Amp Air-cooled Torch

Standard Torch Body **	Part No.	Stock No.
With 4ft. / 1,22m Cable Assembly	QFA604	3045-1490
With 6ft. / 1,83m Cable Assembly	QFA606	3045-1491
With 8ft. / 2,44m Cable Assembly	QFA608	3045-1492
With 10ft. / 3m Cable Assembly	QFA610	3045-1493
With 12ft. / 4m Cable Assembly	QFA612	3045-1494
With 15ft. / 5m Cable Assembly	QFA615	3045-1495

Note: Refer to page 14 for detail on how the overall length is measured.

QTR Series 600 amp Air-cooled Robotic Conductor Tube

	18°	22°	45°	60°	180°	22°L	45°L	180°L
Part No.	QTR66-18	QTR66-22	QTR66-45	QTR66-60	QTR66-180	QTR66-22L	QTR66-45L	QTR66-180L
Stock No.	1686-1840	1686-1841	1686-1842	1686-1843	1686-1844	1686-1845	1686-1847	1686-1846

Note: Refer to page 17 for information pertaining to the air-cooled conductor tubes.

Tweco® Robotics offers a complete line of nozzles, diffusers, and contact tips for the above conductor tubes.

Robotic Style Nozzles (REL & RWC Series)

All nozzles are machined from solid copper bar stock that assures consistent dimensional stability and an efficient dissipation of heat. The nozzles are nickel-plated and are insulated to act as a barrier for the spatter bridging between the nozzle and gas diffuser.

Robotic Diffusers

All of the diffusers are machined from a brass alloy and contain twelve gas holes for better distribution of the shielding gas. There are diffusers for both the threaded and cam style contact tips.

Robotic Contact Tips (RS & RZ Series)

Robotic contact tips are offered in two different materials that provide better performance versus the pure copper contact tips used on the hand-held MIG guns. The RS series are machined from a copper-silver material that has better conductivity - resistance properties, reducing the micro arcing on the inside diameter that occurs with the pure copper contact tips. The RZ series are machined from a chrome zirconium – copper material that is harder than the pure copper contact tips providing better wear resistance properties.

QFA Replacement Part

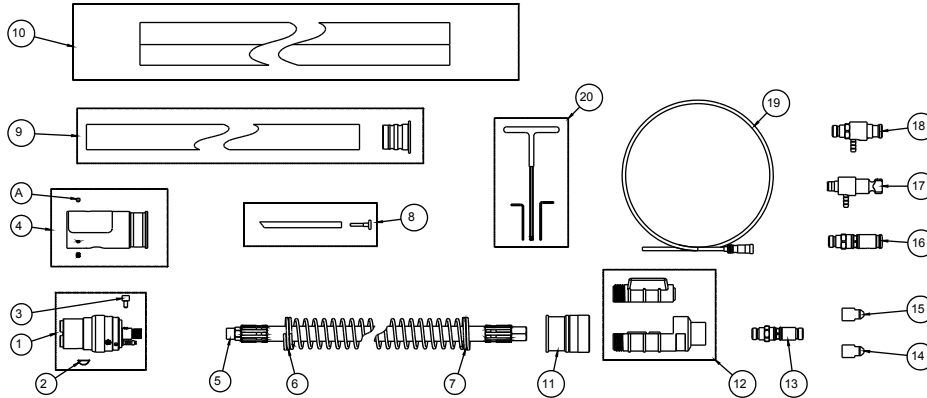

Item No.	Part No.	Stock No.	Description
1	---	---	Cartridge Kit - (Includes Item #2, #3, and Hose Clamps) For use with 1-5/8" (41,28mm) Ø Mount – QRA Series - ***
NS	QRA-1BC	3045-1150	
2	QR106RLS	3045-1341	Replacement Locking Set Screw F/Torch Block (Pkg. of 5 ea.)
2	---	---	Key
	QTRMS-BS	3045-1156	For use with QRA-1BC Cartridge Kit (Pkg. of 5 ea.)
3	QR106-S	3045-1158	Conduit Screw (Pkg. of 5 ea.)
4	QR-FC	3045-1161	Front Case (Includes Item "B")
5	---	---	QFA Power Cable Assy (Includes Hose Clamps)
	QR604-CH	3045-1166	For use with 4ft. (1,22m) torch
	QR606-CH	3045-1170	For use with 6ft. (1,83m) torch
	QR608-CH	3045-1172	For use with 8ft. (2,44m) torch
	QR610-CH	3045-1173	For use with 10ft. (3m) torch
	QR612-CH	3045-1174	For use with 12ft. (4m) torch
	QR615-CH	3045-1175	For use with 15ft. (5m) torch
6	---	---	Front Spring
	QR-SPR	3045-1177	For use with 4ft. (1,22m) through 7ft. (2,13m) torches
	QR-SPHD	3045-1178	For use with 8ft. (2,44m) through 15ft. (5m) torches
7	---	---	Rear Spring
	QR-SPR	3045-1177	For use with 4ft. (1,22m) through 7ft. (2,13m)
	QR-SPHD	3045-1178	For use with 4ft. (1,22m) through 15ft. (5m) torches
8	---	---	Purge Hose Assembly (Includes Hose Plug Nipple & Clamp)
	QR04-PH	3045-1202	For use with 4ft. (1,22m) torch
	QR06-PH	3045-1206	For use with 6ft. (1,83m) torch
	QR08-PH	3045-1208	For use with 8ft. (2,44m) torch
	QR10-PH	3045-1209	For use with 10ft. (3m) torch
	QR12-PH	3045-1210	For use with 12ft. (4m) torch
	QR15-PH	3045-1211	For use with 15ft. (5m) torch
9	---	---	Cable Cover Kit
	QR04-CV	3045-1215	For use with 4ft. (1,22m) torch
	QR06-CV	3045-1219	For use with 6ft. (1,83m) torch
	QR08-CV	3045-1221	For use with 8ft. (2,44m) torch
	QR10-CV	3045-1222	For use with 10ft. (3m) torch
	QR12-CV	3045-1223	For use with 12ft. (4m) torch
	QR15-CV	3045-1224	For use with 15ft. (5m) torch
10	---	---	Outer Cover Assembly (Includes Cable Tie – 2 ea.)
	QR04-LC	3045-1228	For use with 4ft. (1,22m) torch
	QR06-LC	3045-1232	For use with 6ft. (1,83m) torch

Item No.	Part No.	Stock No.	Description
10	QR08-LC	3045-1234	For use with 8ft. (2,44m) torch
	QR10-LC	3045-1235	For use with 10ft. (3m) torch
	QR12-LC	3045-1236	For use with 12ft. (4m) torch
	QR15-LC	3045-1237	For use with 15ft. (5m) torch
11	QR-RC	3045-1238	Rear Spring Cap
12	QRA-CS	3045-1239	Rear Case Assembly
13	R176MH	2060-2184	Miller® Connector Plug (Includes Items #16 & 17) - ***
	R174MH	2035-2109	Miller Connector Plug (Includes Items #16 & #17)
14	R175M-N045	2050-2181	Miller Plug Nipple, .045" (1,0mm) Wire (Use w/R176MH) - ***
	R174M-N045	2040-2192	Miller Plug Nipple, .045" (1,0mm) Wire (Use w/R174MH)
15	R175M-N116	2050-2182	Miller Plug Nipple, .062" (1,6mm) Wire (Use w/R176MH) - ***
	R174M-N116	2040-2191	Miller Plug Nipple, .062" (1,6mm) Wire (Use w/R174MH)
NS	R175MN18	2050-2183	Miller Plug Nipple, .125" (3,18mm)
16	176S-H	2060-2177	Tweco® Connector Plug - ***
	350-174H	2035-2110	Tweco Connector Plug (Uses R44 series Conduit)
17	350-174PH	2035-2172	Panasonic® Connector Plug (Uses R44 series Conduit)
18	QTR176LH	2086-2624	Lincoln® Connector Plug (2.71" – 68,83mm OAL.) - ***
	EL176LH	2060-2680	Lincoln Connector Plug (3.84" – 97,54mm OAL)
	QTR174LH	2086-2623	Lincoln Connector Plug (Uses R44 series Conduit)
19	---	---	Conduit (Refer to Pages 58 and 59)
20	QTR-TOOLS	2062-2034	Tool Kit

Standard Fasteners

These standard fasteners are not sellable items and must be purchased at a local hardware or fastener supply house.

Item No.	Description
A	#10-32 x 3/16" Stainless Cup Point Set Screw

Miller is a registered trademark of Illinois Tool Works, Inc. Lincoln is a registered trademark of Lincoln Electric Co. Panasonic is a registered trademark of Matsushita Electric Industrial Co., Ltd. The afore mentioned registered trademarks are in no way affiliated with Tweco Robotics or Thermadyne Industries, Inc. Tweco is a registered trademark of Thermadyne Industries, Inc.

QFW Series Water-cooled Automation Gun and Cable Assembly

Benefits:

- Incorporates a power cable similar to the one found on the QFA air-cooled MIG gun and cable assembly.
- Separate water lines are used to carry the water to and from the torch body.

Standard Features:

- Water shut-off valves located in the torch body assembly
- Color coded “water-in” and “water-out” hoses for easier hook-up
- Water hose quick connections
- High flow rate – QFW series - for improved conductor tube cooling

QFW Series 600 Amp Water-cooled Torch

Standard Torch Body **	Part No.	Stock No.
With 4ft. / 1,22m Cable Assembly	QFW604	3045-1675
With 6ft. / 1,83m Cable Assembly	QFW606	3045-1676
With 8ft. / 2,44m Cable Assembly	QFW608	3045-1677
With 10ft. / 3m Cable Assembly	QFW610	3045-1678
With 12ft. / 4m Cable Assembly	QFW612	3045-1679
With 15ft. / 5m Cable Assembly	QFW615	3045-1680

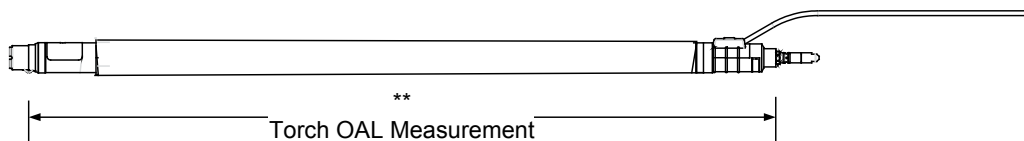

Note: Overall length is measured from where the shoulder on the aluminum sleeve bottoms out against the fixture to the back of the rear molded case within +/- 1 inch. Refer to the figure above.

QTRW Series 300 & 400 & 600 amp Water-Cooled Robotic Conductor Tube

QTRW63 Series (300 amp) Conductor Tube

	18°	22°	45°	60°	180°	22°L	45°L	180°L
Part No.	QTRW63-18	QTRW63-22	QTRW63-45	QTRW63-60	QTRW63-180	QTRW63-22L	QTRW63-45L	QTRW63-180L
Stock No.	1636-1125	1636-1126	1636-1128	1636-1130	1636-1131	1636-1127	1636-1129	1636-1132

QTRW64 Series (400 amp) Conductor Tube

	18°	22°	45°	60°	180°	22°L	45°L	180°L
Part No.	QTRW64-18	QTRW64-22	QTRW64-45	QTRW64-60	QTRW64-180	QTRW64-22L	QTRW64-45L	QTRW64-180L
Stock No.	1646-1700	1646-1701	1646-1702	1646-1703	1646-1704	1646-1705	1646-1707	1646-1706

QTRW66 Series (600 amp) Conductor Tube

	18°	22°	45°	60°	180°	22°L	45°L	180°L
Part No.	QTRW66-18	QTRW66-22	QTRW66-45	QTRW66-60	QTRW66-180	QTRW66-22L	QTRW66-45L	QTRW66-180L
Stock No.	1663-1700	1663-1701	1663-1702	1663-1703	1663-1704	1663-1705	1663-1707	1663-1706

Note: Refer to page 20 for information pertaining to the water-cooled conductor tubes.

QFW Series Replacement Parts

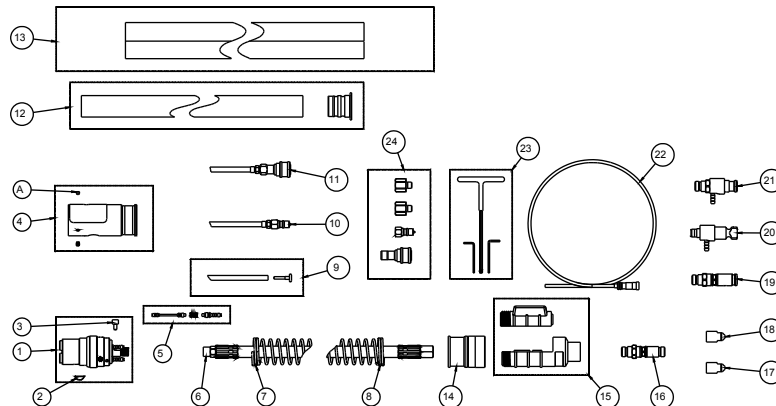

Item No.	Part No.	Stock No.	Description
1	---	---	Cartridge Kit - (Includes Item #2, #3 and Hose Clamps)
	QRWA-1BC	3045-1288	For use with 1-5/8" (41,28mm) Ø Mount – QRWA Series - ***
NS	QR106RLS	3045-1341	Replacement Locking Set Screw F/Torch Block (Pkg. of 5 ea.)
2	---	---	Key
	QTRMS-BS	3045-1156	For use with QRA-1BC (Pkg. Of 5 ea.)
3	QR106-S	3045-1158	Conduit Screw (Pkg. Of 5 ea.)
4	QR-FC	3045-1161	Front case (Includes Item "B")
5	QRW-CV	3045-1304	Check Valve Assembly (Includes O-rings)
6	---	---	QFW Power Cable Assy (Includes Hose Clamp)
	QR604-CH	3045-1166	For use with 4ft. (1,22m) torch
	QR606-CH	3045-1170	For use with 6ft. (1,83m) torch
	QR608-CH	3045-1172	For use with 8ft. (2,44m) torch
	QR610-CH	3045-1173	For use with 10ft. (3m) torch
	QR612-CH	3045-1174	For use with 12ft. (4m) torch
	QR615-CH	3045-1175	For use with 15ft. (5m) torch
7	---	---	Front Spring
	QR-SPR	3045-1177	For use with 4ft. (1,22m) through 7ft. (2.13m) torches
	QR-SPHD	3045-1178	For use with 8ft. (2,44m) through 15ft. (5m) torches
8	---	---	Rear Spring
	QR-SPR	3045-1177	For use with 4ft. (1,22m) through 7ft. (2.13m) torches
	QR-SPHD	3045-1178	For use with 4ft. (1,22m) through 15ft. (5m) torches
9	---	---	Purge Hose Assembly (Includes Hose Nipple Plug & Hose Clamp)
	QR04-PH	3045-1202	For use with 4ft. (1,22m) torch
	QR06-PH	3045-1206	For use with 6ft. (1,83m) torch
	QR08-PH	3045-1208	For use with 8ft. (2,44m) torch
	QR10-PH	3045-1209	For use with 10ft. (3m) torch
	QR12-PH	3045-1210	For use with 12ft. (4m) torch
	QR15-PH	3045-1211	For use with 15ft. (5m) torch
10	---	---	Water-Out Hose Assembly (Includes Hose Clamp)
	QRW04-WO	3045-1265	For use with 4ft. (1,22m) torch
	QRW06-WO	3045-1269	For use with 6ft. (1,83m) torch
	QRW08-WO	3045-1271	For use with 8ft. (2,44m) torch
	QRW10-WO	3045-1272	For use with 10ft. (3m) torch
	QRW12-WO	3045-1273	For use with 12ft. (4m) torch
	QRW15-WO	3045-1274	For use with 15ft. (5m) torch

Item No.	Part No.	Stock No.	Description
11	---	---	Water-In Hose Assembly (Includes Hose Clamps)
	QRW04-WI	3045-1277	For use with 4ft. (1,22m) torch
	QRW06-WI	3045-1281	For use with 6ft. (1,83m) torch
	QRW08-WI	3045-1283	For use with 8ft. (2,44m) torch
	QRW10-WI	3045-1284	For use with 10ft. (3m) torch
	QRW12-WI	3045-1285	For use with 12ft. (4m) torch
	QRW15-WI	3045-1286	For use with 15ft. (5m) torch
12	---	---	Cable Cover Kit
	QR04-CV	3045-1215	For use with 4ft. (1,22m) torch
	QR06-CV	3045-1219	For use with 6ft. (1,83m) torch
	QR08-CV	3045-1221	For use with 8ft. (2,44m) torch
	QR10-CV	3045-1222	For use with 10ft. (3m) torch
	QR12-CV	3045-1223	For use with 12ft. (4m) torch
	QR15-CV	3045-1224	For use with 15ft. (5m) torch
13	---	---	Outer Cover Assembly (Includes Cable Tie – 2 ea.)
	QR04-LC	3045-1228	For use with 4ft. (1,22m) torch
	QR06-LC	3045-1232	For use with 6ft. (1,83m) torch
	QR08-LC	3045-1234	For use with 8ft. (2,44m) torch
	QR10-LC	3045-1235	For use with 10ft. (3m) torch
	QR12-LC	3045-1236	For use with 12ft. (4m) torch
	QR15-LC	3045-1237	For use with 15ft. (5m) torch
14	QR-RC	3045-1238	Rear Spring Cap
15	QRWA-CS	3045-1293	QRWA Rear Case Assembly
16	R176MH	2060-2184	Miller® Connector Plug (Includes Items #17 & #18)
	R174MH	2035-2109	Miller Connector Plug (Includes Items #17 & #18)
17	R175M-N045	2050-2181	Miller Plug Nipple, .045" (1,0mm) Wire (Use w/R176MH) ***
	R174M-N045	2040-2192	Miller Plug Nipple, .045" (1,0mm) Wire (Use w/R174MH)
18	R175M-N116	2050-2182	Miller Plug Nipple, .062" (1,6mm) Wire (Use w/R176MH)
	R174M-N116	2040-2191	Miller Plug Nipple, .062" (1,6mm) Wire (Use w/R174MH)
NS	R175MN18	2050-2183	Miller Plug Nipple, .125" (3,18mm)
19	176S-H	2060-2177	Tweco® Connector Plug
	350-174H	2035-2110	Tweco Connector Plug (Uses R44 series Conduit)
20	350-174PH	2035-2172	Panasonic® Connector Plug (Uses R44 series Conduit)
21	QTR176LH	2086-2624	Lincoln® Connector Plug (2.71" – 68,83mm OAL.)
	EL176LH	2060-2680	Lincoln Connector Plug (3.84" – 97,54mm OAL)
	QTR174LH	2086-2623	Lincoln Connector Plug (Uses R44 series Conduit)
22	---	---	Conduit (Refer to Pages 58 and 59)
23	QTR-TOOLS	2062-2034	Tool kit
24	400LK-QC	2044-2000	Quick Connector Male & Female

*** Standard On All QFW Series Torch Body and Cable Assemblies

Standard Fasteners

These standard fasteners are not sellable items and must be purchased at a local hardware or fastener supply house.

Item No.	Description
A	#10-32 x 3/16" Stainless Cup Point Set Screw

Miller is a registered trademark of Illinois Tool Works, Inc. Lincoln is a registered trademark of Lincoln Electric Co. Panasonic is a registered trademark of Matsushita Electric Industrial Co., Ltd. The afore mentioned registered trademarks are in no way affiliated with Tweco Robotics or Thermadyne Industries, Inc. Tweco is a registered trademark of Thermadyne Industries, Inc.

Tweco® Robotics Air-cooled Conductor Tube

The QTR series conductor tube assemblies are constructed to be both extremely rigid and reliable. The inner tube is machined from an extruded copper tube providing excellent electrical conductivity for cool operation even under high amperage applications. The outer jacket is made from a seamless 3/4" outside diameter (OD) stainless steel tube that is insulated from the inner tube by a teflon sleeve providing excellent di-electric properties.

The conductor tubes are positively located into the torch body by the use of two stainless steel alignment pins. These pins ensure the proper relationship with the torch body and robotic mount. The back end of the conductor tube is made from a solid brass connection with a stainless steel alloy wear surface in the area where the tube is drawn and locked in place inside of the torch block. An O-ring seal prevents the shielding gas from escaping and seals against atmospheric air contamination.

QTR Series 600 amp Air-cooled Robotic Conductor Tube

	18°	22°	45°	60°	180°	22°L	45°L	180°L
Part No.	QTR66-18	QTR66-22	QTR66-45	QTR66-60	QTR66-180	QTR66-22L	QTR66-45L	QTR66-180L
Stock No.	1686-1840	1686-1841	1686-1842	1686-1843	1686-1844	1686-1845	1686-1847	1686-1846

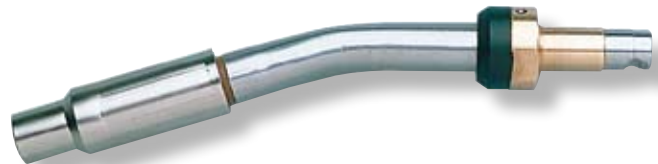
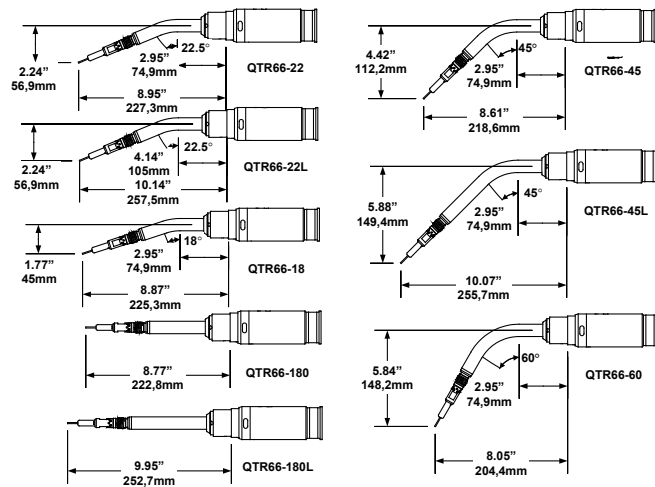

NOTE: Wire Stick-out = 5/8" (15,88mm)

QTR Air-cooled Diffusers

QTR 52 Series Diffusers (For use with REL22CT Nozzle Assembly)

Part No.	Stock No.	
QTR52-14	1520-1116	Use with 14RS, 14RZ & 14H Contact Tips
QTR52-16	1520-1115	Use with 16RS, 16RZ & 16S Contact Tips

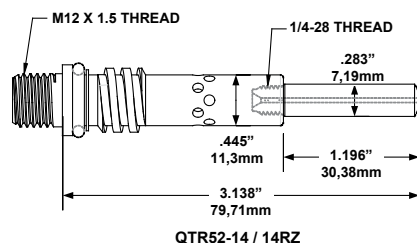

QTR52-14 / 14RZ

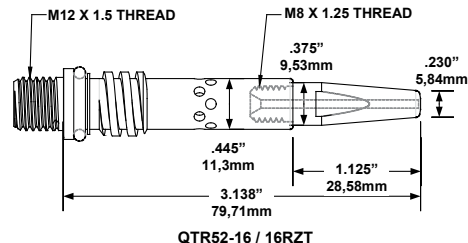

QTR52-16 / 16RZ



QTR54-SW



QTR56-SW

QTR56 & QTR54 Series Diffusers (For use with REL24CT Nozzles)

Part No.	Stock No.	
QTR56-SW	1560-1125	Use with 16RS, 16RZ, & 16S tips - Max. conduit 1/16" wire
QTR56-H	1560-1126	Use with 16RS, 16RZ, & 16S tips - Conduit 5/64" & larger
QTR54-SW	1564-1130	Use with ELRS16 & EL16 tips – Max. conduit 1/16" wire
QTR54-H	1564-1131	Use with ELRS16 & EL16 tips – Conduit 5/64" & larger

Note: Part No. QTR56-SW (Stock No. 1560-1125) comes with all QTR66 Series Conductor Tubes

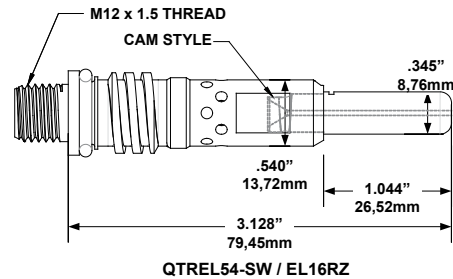
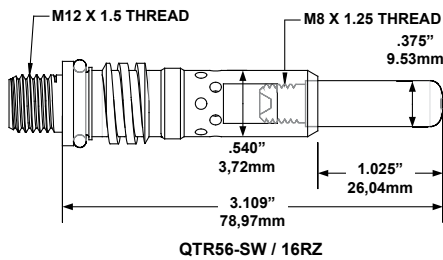

A machined groove around the OD of the Tweco® Robotics gas diffusers should be used by the end user for determining the maximum cut length on any replacement conduit. Refer to the figure below.

Method "A" – Using a tape measure or scale, mark and cut the conduit to the cut length noted in the table below. Refer to — Method "A".

Method "B" – The diffusers have a machined groove around the outer diameter. Position the diffuser as shown in the figure below — Method "B" and mark and cut the conduit.

Conductor Tube Assy.	Cut Length "A"
QTR66 Series – (For use with QRA series torch/cable assemblies)	1-5/16" (33,32mm)
QTRW63 Series – (For use with QRW & QRWA series torch/cable assemblies)	15/16" (23,80mm)
QTRW64 Series – (For use with QRW & QRWA series torch/cable assemblies)	1/4" (6,35mm)
QTRW66 Series – (For use with QRW & QRWA series torch/cable assemblies)	5/16" (7,92mm)

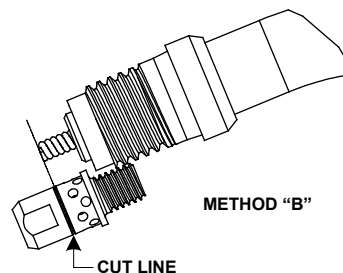
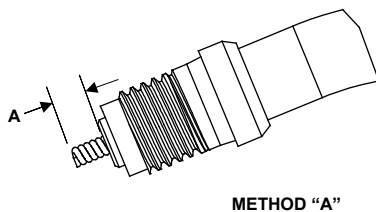



Air-cooled Nozzles

REL24CT-75

REL24CT-62F

REL22CT Nozzle – Standard Tip Recess - .125” to .156” (3,18mm to 3,96mm)

Bore Size	Part No.	Stock No.	A	B	C	D
.375"- 9,5mm	REL22CT-37	1220-1250	.395"/10,03mm	.545"/13,84mm	.943"/23,96mm	.875"/22,23mm
.500"-12,7mm	REL22CT-50	1220-1255	.520"/13,21mm	.670"/17,02mm	1.05"/26,71mm	.875"/22,23mm
.625"-15,9mm	REL22CT-62	1220-1260	.645"/16,38mm	.795"/20,19mm	1.16"/29,46mm	.875"/22,23mm

REL22CT Nozzle – Flush Tip Recess – Flush to .062” (1,57mm)

Bore Size	Part No.	Stock No.	A	B	C	D
.375"- 9,5mm	REL22CT-37F	1220-1251	.395"/10,03mm	.545"/13,84mm	.834"/10,03mm	.875"/22,23mm
.500"-12,7mm	REL22CT-50F	1220-1256	.520"/13,21mm	.670"/17,02mm	.942"/23,94mm	.875"/22,23mm
.625"-15,9mm	REL22CT-62F	1220-1261	.645"/16,38mm	.795"/20,19mm	1.05"/26,71mm	.875"/22,23mm

REL22CT Nozzle – Protruding Tip Recess - .125” to .187” (3,18mm to 4,75mm)

Bore Size	Part No.	Stock No.	A	B	C	D
.375"- 9,5mm	REL22CT-37P	1220-1252	.395"/10,03mm	.545"/13,84mm	.647"/16,44mm	.875"/22,23mm
.500"-12,7mm	REL22CT-50P	1220-1257	.520"/13,21mm	.670"/17,02mm	.755"/19,19mm	.875"/22,23mm
.625"-15,9mm	REL22CT-62P	1220-1262	.645"/16,38mm	.795"/20,19mm	.864"/21,94mm	.875"/22,23mm

REL24CT Nozzle – Standard Tip Recess - .125” to .156” (3,18mm to 3,96mm)

Bore Size	Part No.	Stock No.	A	B	C	D
.500"-12,7mm	REL24CT-50	1240-1305	.520"/13,21mm	.670"/17,02mm	.882"/22,4mm	1.00"/25,4mm
.625"-15,9mm	REL24CT-62	1240-1306	.645"/16,38mm	.790"/20,1mm	.952"/24,19mm	1.00"/25,4mm
.750"-19,1mm	REL24CT-75	1240-1307	.770"/19,56mm	.920"/23,2mm	1.03"/26,16mm	1.00"/25,4mm

REL24CT Nozzle – Flush Tip Recess - Flush to .062” (1,57mm)

Bore Size	Part No.	Stock No.	A	B	C	D
.500"-12,7mm	REL24CT-50F	1240-1315	.520"/13,21mm	.670"/17,02mm	.772"/19,61mm	1.00"/25,4mm
.625"-15,9mm	REL24CT-62F	1240-1316	.645"/16,38mm	.790"/20,1mm	.842"/21,4mm	1.00"/25,4mm
.625"-15,9mm	REL24CT-62FL	1240-1318	.645"/16,38mm	.790"/20,1mm	1.55"/39,48mm	1.00"/25,4mm
.750"-19,1mm	REL24CT-75F	1240-1317	.770"/19,56mm	.920"/23,2mm	.916"/23,7mm	1.00"/25,4mm

REL24CT Nozzle – Protruding Tip Recess - .125” to .187” (3,18mm to 4,75mm)

Bore Size	Part No.	Stock No.	A	B	C	D
.500"-12,7mm	REL24CT-50P	1240-1310	.520"/13,21mm	.670"/17,02mm	.585"/14,86mm	1.00"/25,4mm
.625"-15,9mm	REL24CT-62P	1240-1311	.645"/16,38mm	.790"/20,1mm	.655"/16,65mm	1.00"/25,4mm
.750"-19,1mm	REL24CT-75P	1240-1312	.770"/19,56mm	.920"/23,2mm	.729"/18,52mm	1.00"/25,4mm

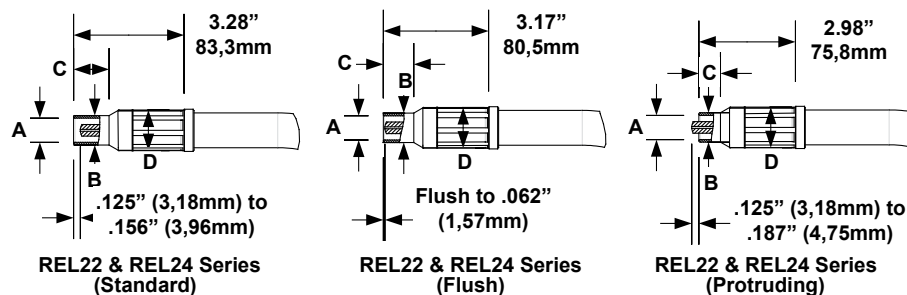

Tweco® Robotics Water-cooled Conductor Tube

The QTRW series conductor tube is a rugged and fully insulated design. The outer jacket contains the nozzle housing with a thermally conductive insulator to draw the heat out of the nozzle. A teflon sleeve insulates the outer jacket from the inner tube assembly. The strength of the outer jacket comes from the use of a 3/4" OD stainless steel seamless tube brazed in between the copper nozzle housing and the brass crimp ring.

The inner tube is constructed from a brass and copper duplex style extruded tube. The front end of the brazed inner tube is tapered to fit between itself and the nozzle housing. This provides a solid heat transfer path between the inner tube and jacket assembly. The back end of the conductor tube is made from a stainless steel alloy that increases the strength of the conductor tube.

The conductor tubes are positively secured in the torch body by the use of two stainless steel alignment pins. These pins ensure the proper relationship with the torch body and robotic mount arm. The conductor tube is drawn into the torch body by the use of a stainless steel locking screw.

The water-cooled feature of the torch allows the water to flow through the torch body into the conductor tube. The cold water flows to the front of the conductor tube where it circulates around the nozzle area of the torch drawing heat out of the gas diffuser, contact tip and nozzle. The water then returns back down the torch towards the water circulator.

The QTRW series conductor tubes are available in three different amperage ranges and various degrees of bend configurations.

- QTRW63 Series – Robotic welding applications up to 300 amperes
- QTRW64 Series – Robotic welding applications up to 400 amperes
- QTRW66 Series – Robotic welding applications up to 600 amperes

Note: QTRW series conductor tubes are furnished with diffusers that accepts the 11RS series contact tip for QTRW63 series and 14RS/RZ & 16RS/RZ contact tips for QTRW64 and QTRW66 series.

QTRW Series QTRW63 Series (300 amp) Conductor Tube

	18°	22°	45°	60°	180°	22°L	45°L	180°L
Part No.	QTRW63-18	QTRW63-22	QTRW63-45	QTRW63-60	QTRW63-180	QTRW63-22L	QTRW63-45L	QTRW63-180L
Stock No.	1636-1125	1636-1126	1636-1128	1636-1130	1636-1131	1636-1127	1636-1129	1636-1132

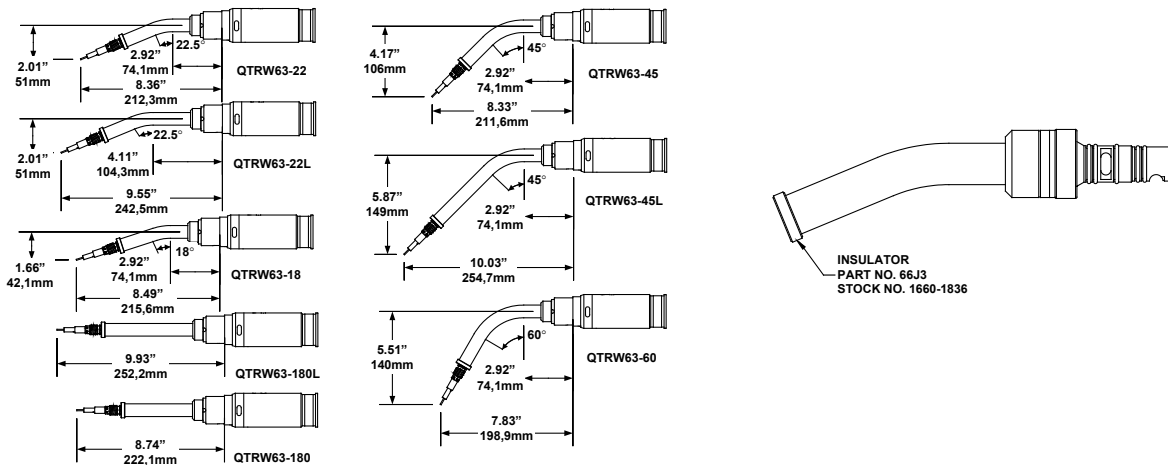

NOTE: Wire Stick-out = 5/8" (15,88mm)

**QTRW Water-cooled Diffusers
300 Amp Diffuser**

Part No.	Stock No.	
EL51	1510-1105	Use with EL11 Tips
QTRW53-11	1525-1141	Use with 11RS Tips

Note: Part No. QTRW53-11 (Stock No. 1525-1141) comes with all QTRW63 Series Conductor Tubes

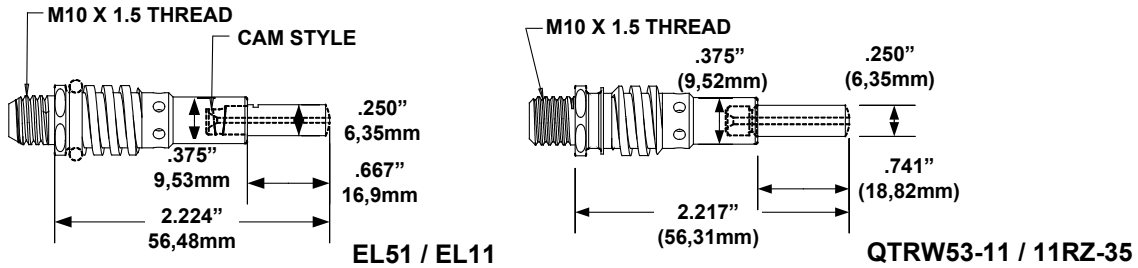

REL21 Nozzle Standard Tip Recess - .125" to .156" (3,17mm to 3,96mm)

Bore Size	Part No.	Stock No.	A	B	C	D
.500"-12,7mm	REL21-50	1210-1311	.520"/13,21mm	.633"/16,08mm	.766"/19,46mm	.875"/22,23mm

REL21 Nozzle Flush Tip Recess – Flush to .062" (1,57mm)

Bore Size	Part No.	Stock No.	A	B	C	D
.500"-12,7mm	REL21-50F	1210-1316	.520"/13,21mm	.633"/16,08mm	.656"/16,66mm	.875"/22,23mm

REL21 Nozzle Protruding Tip Recess - .125" to .187" (3,17mm to 4,75mm)

Bore Size	Part No.	Stock No.	A	B	C	D
.500"-12,7mm	REL21-50P	1210-1321	.520"/13,21mm	.633"/16,08mm	.466"/11,84mm	.875"/22,23mm

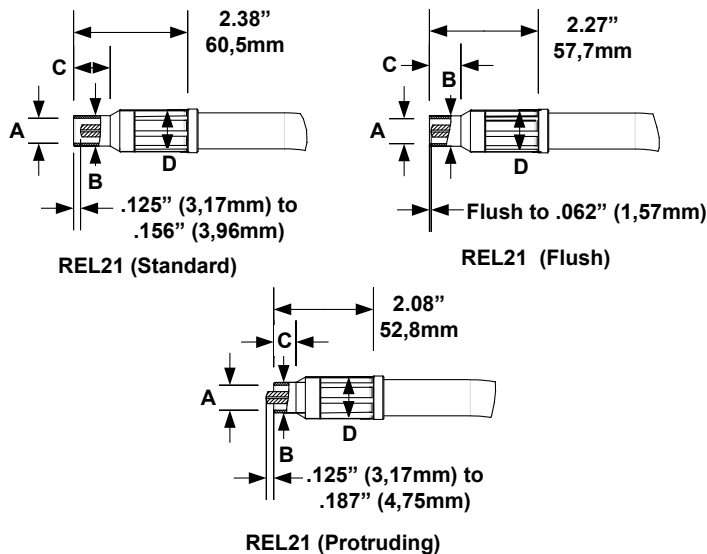

QTRW Series 400 & 600 amp Water-cooled Robotic Conductor Tube
QTRW64 Series (400 amp) Conductor Tube

	18°	22°	45°	60°	180°	22°L	45°L	180°L
Part No.	QTRW64-18	QTRW64-22	QTRW64-45	QTRW64-60	QTRW64-180	QTRW64-22L	QTRW64-45L	QTRW64-180L
Stock No.	1646-1700	1646-1701	1646-1702	1646-1703	1646-1704	1646-1705	1646-1707	1646-1706

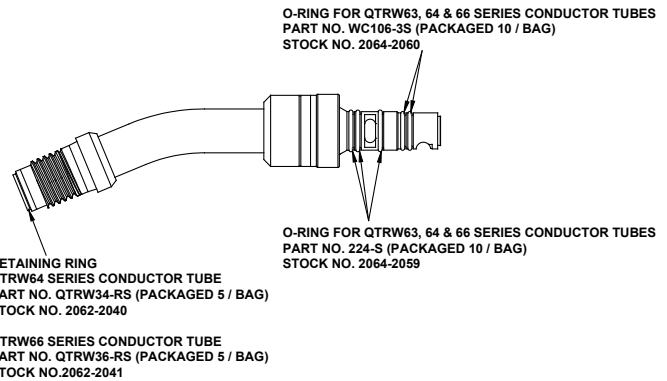

QTRW66 Series (600 amp) Conductor Tube

	18°	22°	45°	60°	180°	22°L	45°L	180°L
Part No.	QTRW66-18	QTRW66-22	QTRW66-45	QTRW66-60	QTRW66-180	QTRW66-22L	QTRW66-45L	QTRW66-180L
Stock No.	1663-1700	1663-1701	1663-1702	1663-1703	1663-1704	1663-1705	1663-1707	1663-1706

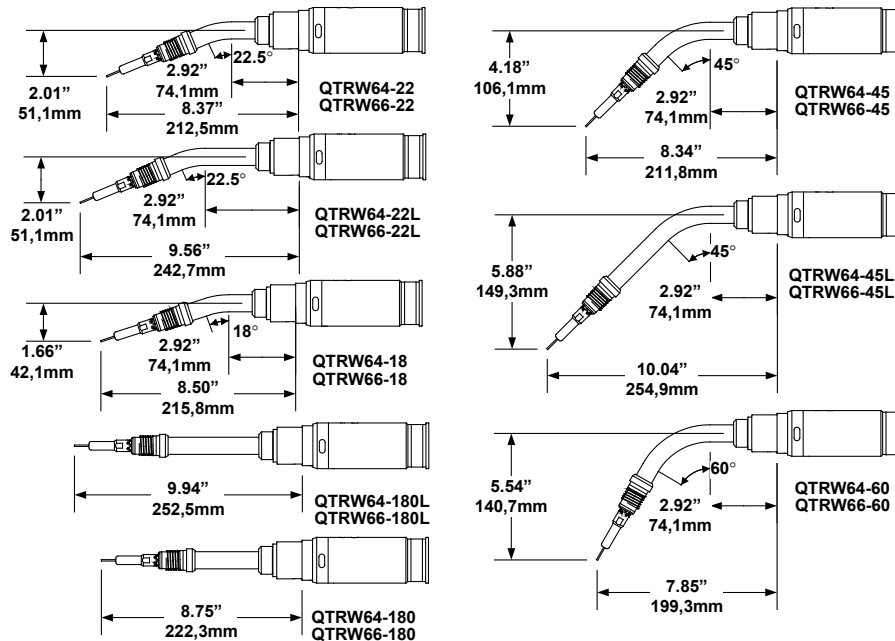

NOTE: Wire Stick-out = 5/8" (15,88mm)

RWC Nozzle



RWC24-50



RWC26-75

Standard Features:

- Machined from solid copper bars to assure consistent dimensional stability and an efficient dissipation of heat.
- Nozzles are nickel-plated.
- Furnished with a spatter shield that acts as a barrier for the spatter bridging between the nozzle and gas diffuser.
- RWC24 series nozzles will fit the QTRW64 robotic conductor tube assemblies.
- RWC26 series nozzles will fit the QTRW66 series robotic conductor tube assemblies.

RWC24 & RWC26 Nozzle Standard Tip Recess - .125" to .156" (3,17mm to 3,96mm)

Bore Size	Part No.	Stock No.	A	B	C	D
.375"- 9,5mm	RWC24-37	1240-1330	.40"/10,2mm	.51"/13,0mm	.87"/22,1mm	1.00"/25,4mm
.500"-12,7mm	RWC24-50	1240-1331	.52"/13,2mm	.63"/16,1mm	.94"/23,8mm	1.00"/25,4mm
.625"-15,9mm	RWC24-62	1240-1332	.65"/16,4mm	.82"/20,8mm	.97"/24,3mm	1.00"/25,4mm
.750"-19,1mm	RWC24-75	1240-1333	.77"/19,6mm	.95"/24,1mm	1.23"/31,3mm	1.00"/25,4mm
.500"-12,7mm	RWC26-50	1264-1430	.52"/13,2mm	.63"/16,1mm	.80"/20,3mm	1.06"/27,0mm
.625"-15,9mm	RWC26-62	1264-1431	.65"/16,4mm	.82"/20,8mm	.89"/22,7mm	1.06"/27,0mm
.750"-19,1mm	RWC26-75	1264-1432	.77"/19,6mm	.94"/23,8mm	.95"/24,6mm	1.06"/27,0mm

RWC24 & RWC26 Nozzle Flush Recess – Flush to .062" (1,57mm)

Bore Size	Part No.	Stock No.	A	B	C	D
.375"- 9,5mm	RWC24-37F	1240-1340	.40"/10,2mm	.51"/13,0mm	.76"/19,3mm	1.00"/25,4mm
.500"-12,7mm	RWC24-50F	1240-1341	.52"/13,2mm	.63"/16,1mm	.83"/21,0mm	1.00"/25,4mm
.625"-15,9mm	RWC24-62F	1240-1342	.65"/16,4mm	.82"/20,8mm	.85"/21,5mm	1.00"/25,4mm
.750"-19,1mm	RWC24-75F	1240-1343	.77"/19,6mm	.95"/24,1mm	1.12"/28,5mm	1.00"/25,4mm
.500"-12,7mm	RWC26-50F	1264-1440	.52"/13,2mm	.63"/16,1mm	.69"/17,5mm	1.06"/27,0mm
.625"-15,9mm	RWC26-62F	1264-1441	.65"/16,4mm	.82"/20,8mm	.78"/19,9mm	1.06"/27,0mm
.750"-19,1mm	RWC26-75F	1264-1442	.77"/19,6mm	.94"/23,8mm	.84"/21,4mm	1.06"/27,0mm

RWC24 & RWC26 Nozzle Protruding Recess - .125" to .187" (3,17mm to 4,75mm)

Bore Size	Part No.	Stock No.	A	B	C	D
.375"- 9,5mm	RWC24-37P	1240-1335	.40"/10,2mm	.51"/13,0mm	.57"/14,5mm	1.00"/25,4mm
.500"-12,7mm	RWC24-50P	1240-1336	.52"/13,2mm	.63"/16,1mm	.64"/16,3mm	1.00"/25,4mm
.625"-15,9mm	RWC24-62P	1240-1337	.65"/16,4mm	.82"/20,8mm	.66"/16,7mm	1.00"/25,4mm
.750"-19,1mm	RWC24-75P	1240-1338	.77"/19,6mm	.95"/24,1mm	.93"/23,7mm	1.00"/25,4mm
.500"-12,7mm	RWC26-50P	1264-1435	.52"/13,2mm	.63"/16,1mm	.51"/12,8mm	1.06"/27,0mm
.625"-15,9mm	RWC26-62P	1264-1436	.65"/16,4mm	.82"/20,8mm	.60"/15,2mm	1.06"/27,0mm
.750"-19,1mm	RWC26-75P	1264-1437	.77"/19,6mm	.94"/23,8mm	.66"/16,7mm	1.06"/27,0mm

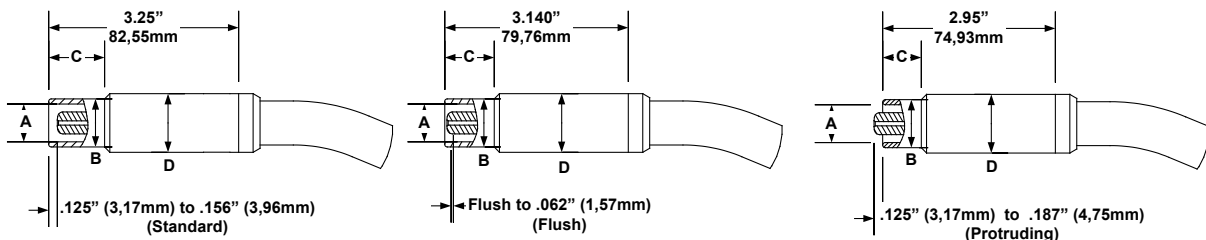

400 amp Diffusers



WC53-EL

QTRW54

Standard Features:

- Machined from solid brass alloy bars.
- Twelve gas holes, .094" (2,38mm) Ø for increased gas distribution over the standard 6 hole design.
- A machined groove around the outside diameter of the gas diffusers to aid in cutting replacement conduit.

Part No.	Stock No.	
WC53-EL	1525-1140	Use with EL16RS tips
QTRW54	1544-1125	Use with 14RS or 14RZ tips
QTRW54-16	1544-1126	Use with 16RS or 16RZ tips

Note: Part No. QTRW54-16 (Stock No. 1544-1126) comes with all QTRW64 Series Conductor Tubes

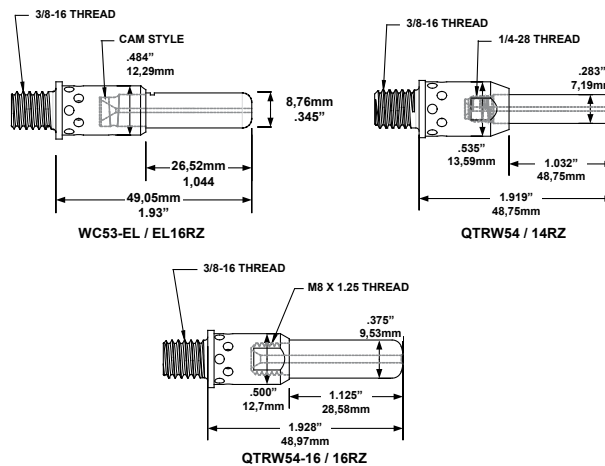

600 amp Diffusers



WC56-EL-SW

QTRW56-SW

Standard Features:

- Machined from solid brass alloy bars.
- Twelve gas holes, .094" (2,38mm) Ø for increased gas distribution over the standard 6 hole design.
- A machined groove around the outside diameter of the gas diffusers to aid in cutting replacement conduit.

Part No.	Stock No.	Stock No.
WC56-EL-SW	1560-1146	Use with EL16RS tips –Conduit 1/16" wire Max
WC56-EL-H	1560-1147	Use with EL16RS tips – Conduit 5/64" & larger
QTRW56-SW	1564-1125	Use with 16RS tips – Conduit 1/16" wire - Max
QTRW56-H	1564-1126	Use with 16RS tips – Conduit 5/64" & larger

Note: Part No. QTRW56-SW (Stock No. 1564-1125) comes with all QTRW66 Conductor Tubes

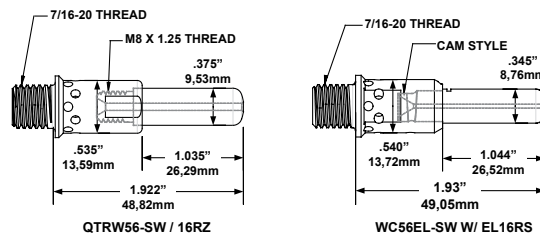

TAM Series Direct Plug Air-cooled Automation MIG Gun

This series of Automation MIG gun is offered without a cable assembly and is for air-cooled welding applications. This style of torch is used when the wire feeder and work piece can be in close proximity to each other and the assembly being welded can rotate or be moved under the conductor tube.

Standard Features:

- Available in 400 and 600 amperes @ 60% duty cycle.
- Two-piece torch body construction, inner tube machined from a brass alloy and the outer sleeve machined from a copper alloy tube. A polyester molding compound is used to bond the two pieces together and provides insulation between the inner tube and outer sleeve.
- The inner tube rear geometry is machined to match the standard Tweco® rear connector plugs, found on the torch and cable assemblies, on both the 400 and 500 ampere torch body.
- TAM400 series comes standard with 24CT-62-S Nozzle, 54A Gas Diffuser, and 14H series Contact Tip. TAM500 series comes standard with 25CT-62 Nozzle, 55SW Gas Diffuser, and 15H series Contact Tip.



TAM400 Series

Part No.	Stock No.	
TAM400-116	3040-1110	Furnished with R44-116-1 Conduit Liner

TAM500 Series

Part No.	Stock No.	
TAM500-116	3050-1110	Furnished with R45-116-1 Conduit Liner

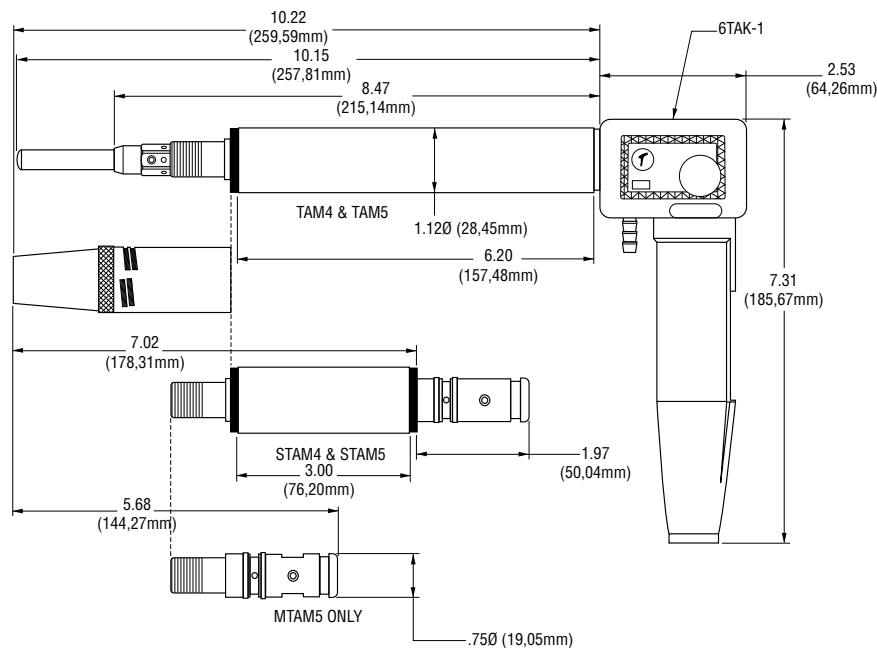

TAM400 & 500 Series Replacement Parts

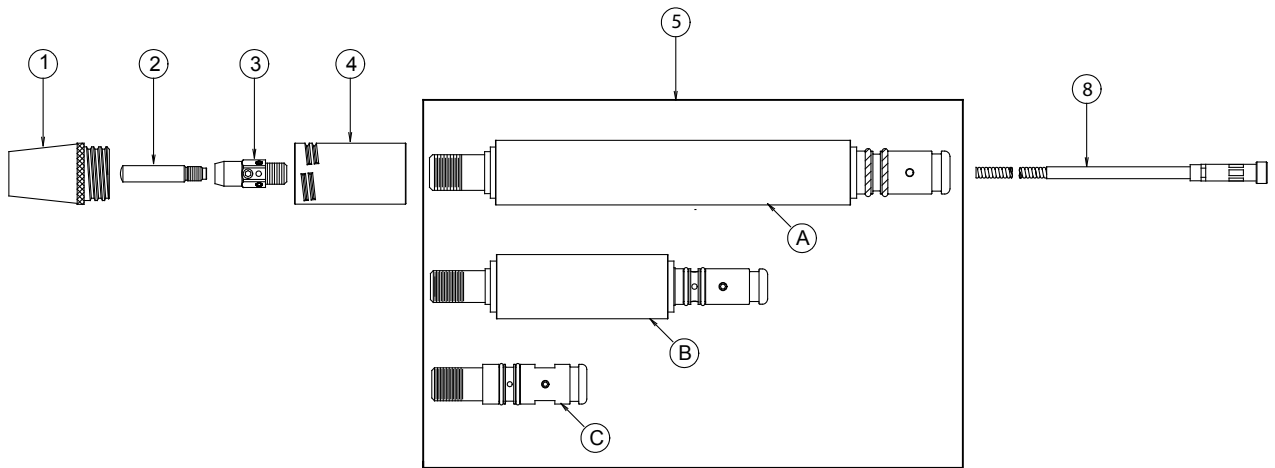

Item No.	Part No.	Stock No.	Description
1	—	—	Nozzle Assembly – Refer to Page 33 through 43
2	—	—	Contact Tip – Refer to Page 56 through 61
3	—	—	Diffuser – Refer to Page 46
4	—	—	Nozzle Insulator – Refer to Page 33 through 43
5	—	—	TAM Direct Plug Body
A	64TAM-174	2080-2401	TAM 400 Amp Body – Overall Length – 9.100” (231,14mm)
	65TAM-175	2080-2501	TAM 500 Amp Body – Overall Length - 9.440” (239,78mm)
B	64STAM-174	2080-2403	TAM 400 Amp Body – Overall Length – 5.900” (149,86mm)
	65STAM-175	2080-2503	TAM 500 Amp Body - Overall Length - 6.240” (158,5mm)
C	65MTAM-175	2080-2504	TAM 500 Amp Body – Overall Length - 2.920” (74,19mm)
NS	224S	2064-2059	O-Ring
6	—	—	Conduit (Refer to Page 62 - 63)

TAM Series Air-cooled Automation MIG Gun and Cable Assembly

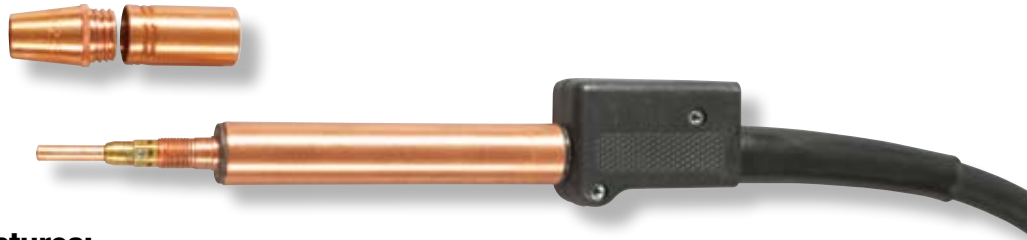

Standard Features:

- Offered for air-cooled welding applications.
- Available in two different series rated at 400 amperes @ 60% duty cycle and 500 amperes @ 60% duty cycle.
- MIG gun and cable assemblies are offered in lengths from 2ft. (.61m) to 15ft. (5m).
- Field repairable.
- The Cablehoz is comprised of three primary components:
 - The outer jacket is a tear-resistant, radiation cross-linked polymer extruded over the copper stranding.
 - The copper is spun around a hytel center core tube, providing flexibility and support for the inner core.
 - The inner core acts as the shielding gas carrier as well as support for the wire conduit assembly.
 - Similar two-piece torch body construction as the direct plug TAM series, however, the inner tube is machined from a copper alloy and the outer sleeve machined from a copper alloy tube. A polyester molding compound is used to bond the two pieces together and provides insulation between the inner tube and outer sleeve.
- Furnished with the standard Tweco® rear connector plugs.
- 400 amp series comes standard with 24CT-62-S Nozzle, 54A Gas Diffuser, and 14H series Contact Tip.
500 amp series comes standard with 25CT-62 Nozzle, 55SW Gas Diffuser, and 15H series Contact Tip.

400 Amp Series

Part No.	Stock No.	Description
TAM402-3545	3040-1101	With 2ft. / .61m Cable Assembly
TAM404-3545	3040-1102	With 4ft. / 1,22m Cable Assembly
TAM406-3545	3040-1103	With 6ft. / 1,83m Cable Assembly
TAM408-3545	3040-1104	With 8 ft. / 2,44m Cable Assembly
TAM410-3545	3040-1105	With 10ft. / 3m Cable Assembly
TAM412-3545	3040-1106	With 12ft. / 4m Cable Assembly
TAM415-3545	3040-1107	With 15ft. / 5m Cable Assembly

Note: MIG Gun and Cable Assemblies are furnished with R44-3545 Conduit

500 Amp Series

Part No.	Stock No.	Description
TAM502-116	3050-1111	With 2ft. / .61m Cable Assembly
TAM504-116	3050-1112	With 4ft. / 1,22m Cable Assembly
TAM506-116	3050-1113	With 6ft. / 1,83m Cable Assembly
TAM508-116	3050-1114	With 8 ft. / 2,44m Cable Assembly
TAM510-116	3050-1115	With 10ft. / 3m Cable Assembly
TAM512-116	3050-1116	With 12ft. / 4m Cable Assembly
TAM515-116	3050-1117	With 15ft. / 5m Cable Assembly

Note: MIG Gun and Cable Assemblies are furnished with R45-116 Conduit

TAM Series Replacement Parts

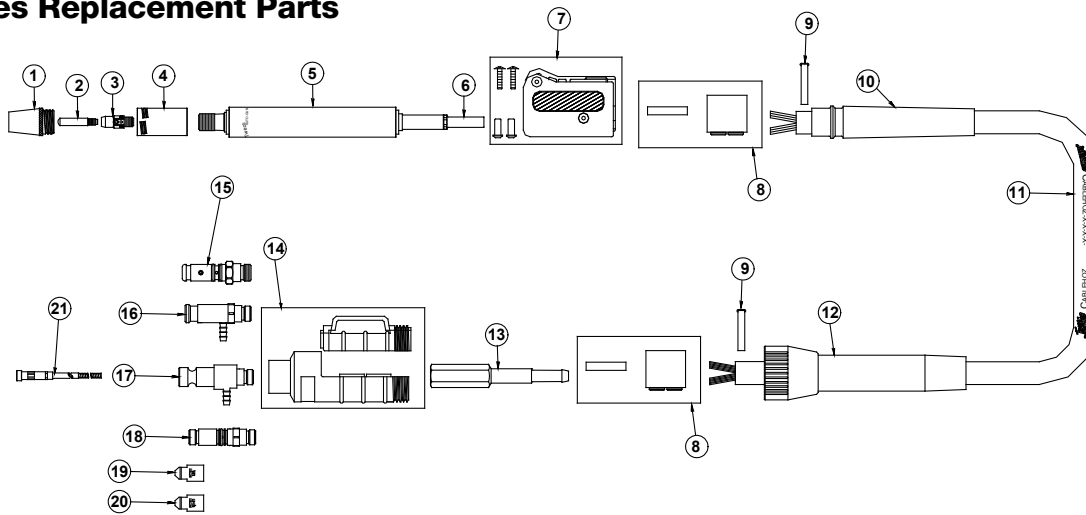

Item No.	Part No.	Stock No.	Description
1	—	—	Nozzle Assembly – Refer to Page 33 through 43
2	—	—	Contact Tip – Refer to Page 56 through 61
3	—	—	Diffuser – Refer to Page 46
4	—	—	Nozzle Insulator – Refer to Page 33 through 43
5	64TAM-N	2080-2400	TAM Body & Nipple – 400 Amp
	64STAM-N	2080-2402	TAM Body & Nipple – 400 Amp
	65TAM-N	2080-2500	TAM Body & Nipple – 500 Amp
6	64N	2040-2064	400 Ampere Gas Nipple
	65N	2050-2065	500 Ampere Gas Nipple
7	185	2050-2185	Connector Case With Screws
8	104	2040-2104	Connector Block With Separator
9	136	2060-2690	Band Clamp
10	234-6	2040-2234	Front Cable Support For 400 Ampere TAM
	235-6	2050-2235	Front Cable Support For 500 Ampere TAM
11	QTR400CS	1740-2520	400 Ampere Cablehoz - (Per Foot)
	QTR600CS	1760-2125	500 Ampere Cablehoz - (Per Foot)
12	234-12	2040-2235	Rear Cable Support & Cap For 400 Ampere TAM
	235-12	2050-2236	Rear Cable Support & Cap For 500 Ampere TAM
13	M170-4H	2020-2166	Direct Plug Adapter For 400 Ampere TAM
	TAM170-6H	2064-2090	Direct Plug Adapter For 500 Ampere TAM
14	WTAM6-RC	2081-2006	Upper & Lower Case
15	176S-H	2060-2177	Tweco® Connector Plug - ***
	350-174H	2035-2110	Tweco Connector Plug (Uses R44 series Conduit)
16	QTR176LH	2086-2624	Lincoln® Connector Plug (2.71" – 68,83mm OAL.)
	EL176LH	2060-2680	Lincoln Connector Plug (3.84" – 97,54mm OAL)
	QTR174LH	2086-2623	Lincoln Connector Plug (Uses R44 series Conduit)
17	350-174PH	2035-2172	Panasonic® Connector Plug (Uses R44 series Conduit)
18	R176MH	2060-2184	Miller® Connector Plug (Includes Items #19 & #20)
	R174MH	2035-2109	Miller Connector Plug (Includes Items #19 & #20)
19	R175M-N045	2050-2181	Miller Plug Nipple, .045" (1,0mm) Wire (Use w/R176MH)
	R174M-N045	2040-2192	Miller Plug Nipple, .045" (1,0mm) Wire (Use w/R174MH)
20	R175M-N116	2050-2182	Miller Plug Nipple, .062" (1,6mm) Wire (Use w/R176MH)
	R174M-N116	2040-2191	Miller Plug Nipple, .062" (1,6mm) Wire (Use w/R174MH)
21	—	—	Conduit (Refer to Page 62 - 63)

Miller is a registered trademark of Illinois Tool Works, Inc. Lincoln is a registered trademark of Lincoln Electric Co. Panasonic is a registered trademark of Matsushita Electric Industrial Co., Ltd. The afore mentioned registered trademarks are in no way affiliated with Tweco Robotics or Thermadyne Industries, Inc. Tweco is a registered trademark of Thermadyne Industries, Inc.

TAM-RAK

Part No. TR-24P (Stock No. 3501-1200)

Part No. TR-32P (Stock No. 3501-1300)

Features:

- Ideal rack device to use to hold the TAM body in place
- Offered with 24 pitch or 32 pitch rack
- Overall length – 6” (152,4mm)

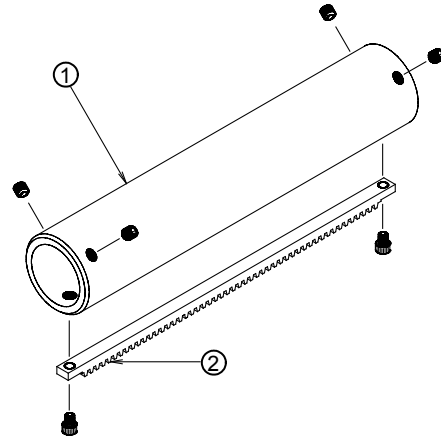
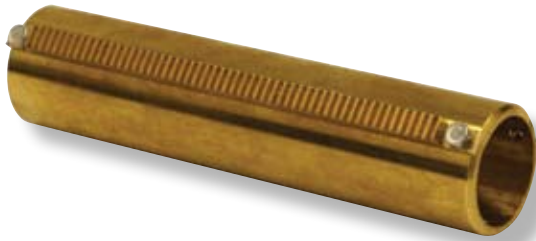

Replacement Parts

Item No.	Part No.	Stock No.	Description
1	TR-1B	3601-2100	Tubular Body With Screws (4 each)
2	TR24-P2	3601-2240	24 Pitch Rack With Screws (2 each)
	TR32-P2	3601-2320	32 Pitch Rack With Screws (2 each)

RA Series Automation MIG Gun and Cable Assembly

This series of Automation MIG guns are offered with a cable assembly and are only offered for air-cooled welding applications.

Standard Features:

- Offered for air-cooled welding applications.
- Available in two different series rated at 400 amperes @ 60% duty cycle and 600 amperes @ 60% duty cycle
- Offered in lengths from 4ft. (1,22m) to 15ft. (5m).
- The Cablehoz is comprised of three primary components:
 - The outer jacket is a tear-resistant, radiation cross-linked polymer extruded over the copper stranding.
 - The copper is spun around a hytrel center core tube, providing flexibility and support for the inner core.
 - The inner core acts as the shielding gas carrier as well as support for the wire conduit assembly.
- Field repairable.
- 1-5/8" (41,28mm) mounting surface.
- Five (5) different bend configuration conductor tubes are available to choose from in each amperage range. Note: The RA Series MIG Gun comes standard with a 22 degree conductor tube.
- Conductor tubes are keyed into the brass body of the assembly allowing a conductor tube to be replaced with minimal adjustments.
- 400 amp series comes standard with 23H-62 Nozzle, 54A Gas Diffuser, and 14H-45 Contact Tip.
- 600 amp series comes standard with 26I-62 Nozzle, 56S-SW Gas Diffuser, and 16S-116 Contact Tip.

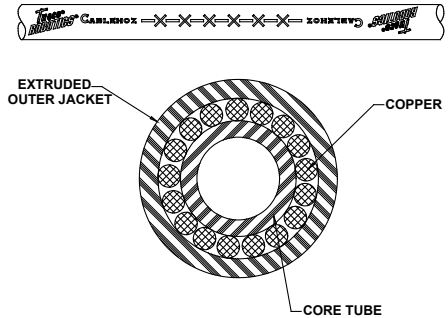

400 Amp Series

Part No.	Stock No.	Description
RA404-3545	3041-1102	With 4ft. / 1,22m Cable Assembly
RA406-3545	3041-1103	With 6ft. / 1,83m Cable Assembly
RA408-3545	3041-1104	With 8ft. / 2,44m Cable Assembly
RA410-3545	3041-1105	With 10ft. / 3m Cable Assembly
RA412-3545	3041-1106	With 12ft. / 4m Cable Assembly
RA415-3545	3041-1107	With 15ft. / 5m Cable Assembly

Note: MIG Gun and Cable Assemblies are furnished with R44-3545 Conduit

600 Amp Series

Part No.	Stock No.	Description
RA606-116	3061-1113	With 6ft. / 1,83m Cable Assembly
RA608-116	3061-1114	With 8ft. / 2,44m Cable Assembly

Note: MIG Gun and Cable Assemblies are furnished with R45-116 Conduit

RA Series Replacement Parts

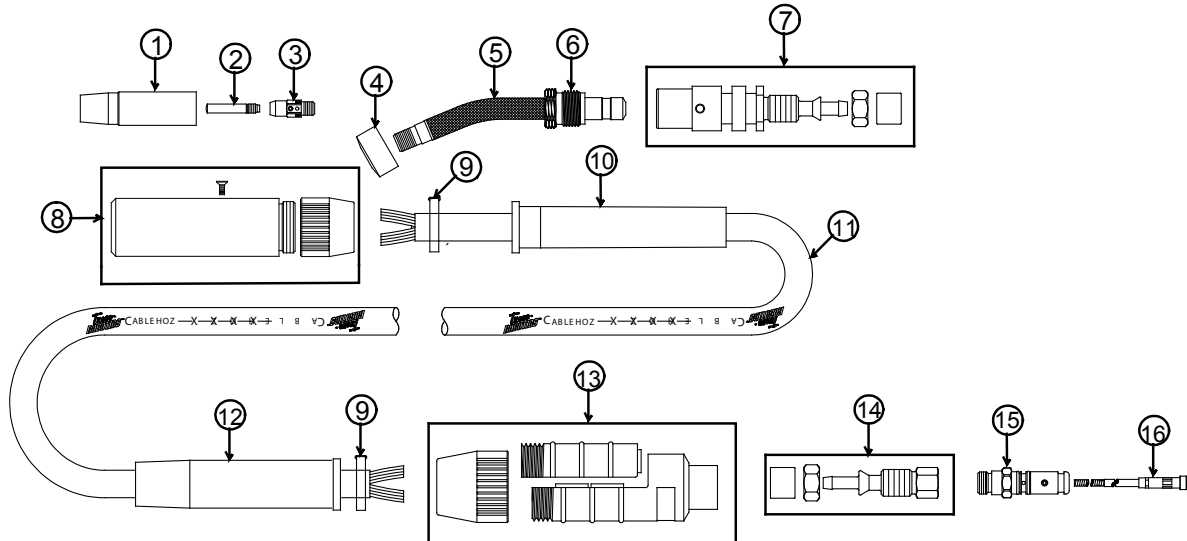

Item No.	Part No.	Stock No.	Description
1	—	—	Nozzle Assembly – Refer to Page 33 through 43
2	—	—	Contact Tip – Refer to Page 56 through 61
3	—	—	Diffuser – Refer to Page 46
4	WR6C	2066-2006	Conductor Tube Nut Cover
5	—	—	Conductor Tube Assembly – Refer to Page 32
6	WR66-N	2066-2066	Conductor Tube Nut
7	RA104	2084-2104	Torch Block – 400 Amp
	RA106	2086-2106	Torch Block – 600 Amp
8	RA6H	2086-2600	Handle Case W/ Strain Relief Cap
9	136	2060-2690	Cablehoz Clamp – 400 Amp
	134-16	2040-2135	Cablehoz Clamp – 600 Amp
10	146T	2080-2646	Strain Relief – Front
11	QTR400C	1740-2520	Cablehoz – 400 Amp
	QTR600C	1760-2125	Cablehoz – 600 Amp
12	350R-230-10	2035-2235	Strain Relief – Rear
13	T6RC	2060-2016	Rear Case
14	350-170K	2035-2171	Rear Power Connection – 400 Amp
	170KL-K	2061-2170	Rear Power Connection – 600 Amp
15	350-174H	2035-2110	Tweco® Connector Plug Assembly – 400 Amp
	176SH	2066-2177	Tweco Connector Plug Assembly – 600 Amp
NS	350-174PH	2035-2172	Panasonic® Connector Plug (Uses R44 series Conduit)
NS	R176MH	2060-2184	Miller® Connector Plug
NS	R174MH	2035-2109	Miller Connector Plug
NS	R175M-N045	2050-2181	Miller Plug Nipple, .045" (1,0mm) Wire (Use w/R176MH)
NS	R174M-N045	2040-2192	Miller Plug Nipple, .045" (1,0mm) Wire (Use w/R174MH)
NS	R175M-N116	2050-2182	Miller Plug Nipple, .062" (1,6mm) Wire (Use w/R176MH)
NS	R174M-N116	2040-2191	Miller Plug Nipple, .062" (1,6mm) Wire (Use w/R174MH)
16	—	—	Conduit (Refer to Page 62 - 63)

Miller is a registered trademark of Illinois Tool Works, Inc. Panasonic is a registered trademark of Matsushita Electric Industrial Co., Ltd. The afore mentioned registered trademarks are in no way affiliated with Tweco Robotics or Thermadyne Industries, Inc. Tweco is a registered trademark of Thermadyne Industries, Inc.

RA Series 400 & 600 amp Conductor Tube

The RA series conductor tubes are constructed to be both rigid and reliable. The conductor tube is machined from a copper alloy tube to provide excellent electrical conductivity for cool operation even under high amperage applications. The outer surface has an epoxy coated fiberglass close woven sleeve material, which is very durable and provides insulation from the copper alloy tube.

Standard Features:

- Two 400 amp series conductor tubes, RA64 and RAEL64. RAEL64 series allows the use of the Eliminator® style diffuser and contact tips.
- Different bend configurations available for each amperage range.
- Conductor tubes are keyed and held in place by a brass threaded nut that presses the conductor tube in place within the torch block assembly.



RA64 Series (400 amp) Conductor Tube

	22°	45°	60°	180°
Part No.	RA64-22	RA64-45	RA64-60	RA64-180
Stock No.	1684-1800	1684-1801	1684-1802	1684-1804

RAEL64 Series (400 amp) Conductor Tube

	22°	45°	180°
Part No.	RAEL64-22	RAEL64-45	RAEL64-180
Stock No.	1684-1826	1684-1827	1684-1829

RA66 Series (600 amp) Conductor Tube

	18°	22°	45°	60°	180°
Part No.	RA66-18	RA66-22	RA66-45	RA66-60	RA66-180
Stock No.	1686-1809	1686-1800	1686-1801	1686-1802	1686-1804

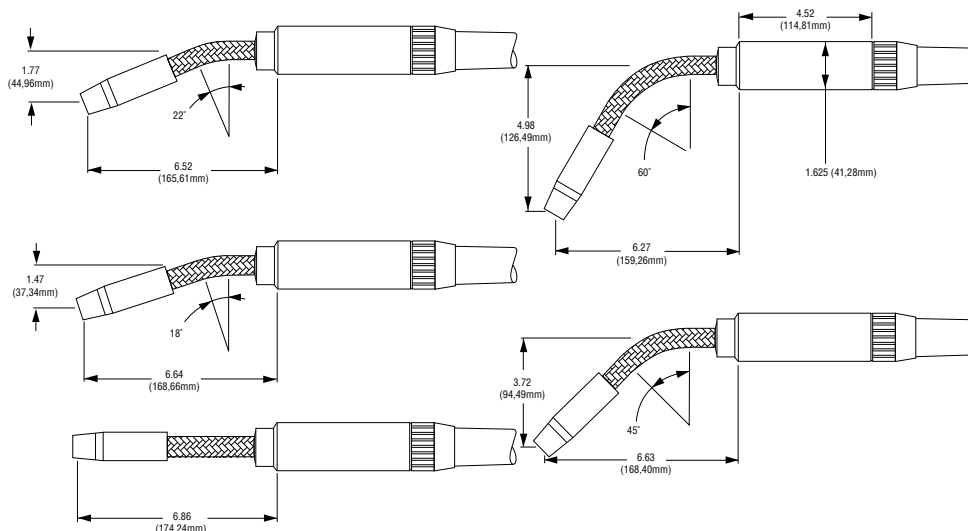

Front End Consumables For TAM and RA Series Torch and Cable Assemblies

Nozzle & Nozzle Insulators

Standard Features:

- Three different styles of nozzles can be used with the TAM and RA series torch body and cable assemblies.
- Several different inside diameter bores to choose from.
- Two different series of threaded nozzles
 - 23 and 26 series nozzle assemblies are made up of three (3) different pieces that are formed, machined and crimped together.
 - Threaded 24CT and 26CT (course thread) series nozzles are machined from a solid copper alloy bar, which assures consistent dimensional stability and an efficient dissipation of heat. It incorporates a nozzle insulator which is made up of three-(3) pieces that are machined, assembled and crimped. Each nozzle is inspected to ensure the nozzle insulator meets the industry di-electric standards.
- The slip-on 24A (adjustable) series nozzle is cut and formed from a copper alloy tube and uses a nozzle insulator that is molded having internal threads to allow the insulator to be threaded onto the conductor tube assembly. The molded insulator is assembled with three (3) metal retaining rings on the outer diameter allowing the inside diameter of the nozzle to slide over the assembled insulator.
- The 23, 24A, 24CT, and HD24 series nozzles will fit the 400 ampere series torch body and cable assemblies. The 26, 26CT, and HD26 series nozzles will fit the 600 ampere series torch body and cable assemblies.



Front End Consumables For TAM and RA Series MIG Gun and Cable Assembly

23 & 26 series Threaded Style Nozzle

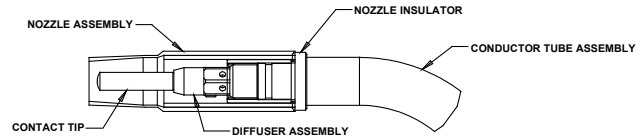

Standard Features:

- Nozzle design consists of three (3) component parts that are formed, machined, assembled and crimped together.
- The nozzle housing is made from a copper alloy tubing, which is cut to length and formed to size.
- The threaded insert is made from a solid brass alloy with internal threads allowing the nozzle assembly to be threaded onto the conductor tube.
- Insert for the 23 series nozzle is threaded to fit 9/16-18 UNF male threads
- Insert for the 26 series nozzle is threaded to fit M17x 2.0-6H male thread.
- A nozzle insulator provides the insulation needed from the conductor tube and nozzle housing.
- Threads directly onto the torch body or conductor tube assembly.

**23 Series –Threaded
1/8” (3,2mm) Tip Recess**

Bore Size “A”	Part No.	Stock No.
.375”-9,5mm	23-37	1230-1100
.500”-12,7mm	23-50	1230-1110
.625”-15,9mm	23-62	1230-1120
.750”-19,1mm	23-75	1230-1130

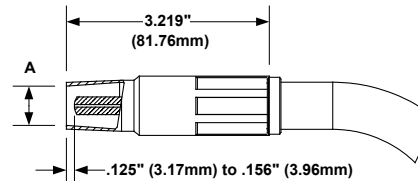

23 Series –Threaded – Flush Tip Recess

Bore Size “A”	Part No.	Stock No.
.375”-9,5mm	23-37-F	1230-1102
.500”-12,7mm	23-50-F	1230-1112
.625”-15,9mm	23-62-F	1230-1122
.750”-19,1mm	23-75-F	1230-1132

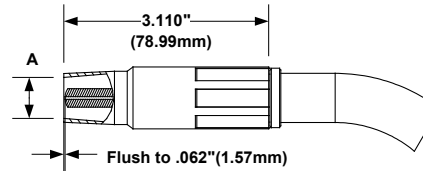

**23 Series – Heavy Duty – Threaded
1/8” (3,2mm) Tip Recess**

Bore Size “A”	Part No.	Stock No.
.500”-12,7mm	23H-50	1230-1210
.625”-15,9mm	23H-62	1230-1220
.750”-19,1mm	23H-75	1230-1230

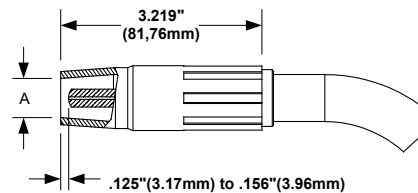

Note: Part No. 23H-62 (Stock No. 1230-1220) comes with all RA400 amp series MIG Guns

600 Amp Threaded Nozzle

26 Series –Threaded – 1/8” (3,2mm) Tip Recess

Bore Size “A”	Part No.	Stock No.
.625”-15,9mm	26I-62	1260-1120
.750”-19,1mm	26I-75	1260-1130
.875”-22,23mm	26I-87	1260-1140

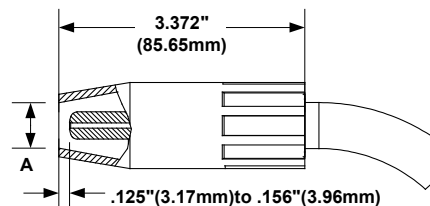

Note: Part No. 26I-62 (Stock No. 1260-1120) comes with all RA600 amp series MIG Guns

“CT” Series Nozzles For TAM and RA Series MIG Gun and Cable Assembly

Standard Features:

- Two-piece nozzle design, consisting of nozzle housing and nozzle insulator housing.
- The nozzle housing is machined from a solid copper alloy bar that assures consistent dimensional stability and an efficient dissipation of heat.
- The nozzle insulator is made up of three (3) component parts:
 - Nozzle Insulator Housing — made from a copper alloy tubing, which is cut to length and formed to size.
 - Nozzle Insert — made from a solid brass alloy with internal threads allowing the nozzle assembly to be threaded onto the conductor tube.
 - Nozzle Insulator — made from G7 silicone material and provides the insulation needed from the conductor tube and nozzle housing.
- The nozzle insulator threads onto the torch body or conductor tube assembly. The nozzle housing is threaded onto the nozzle insulator.
- Nozzle Housing and Nozzle Insulator are ordered separately.

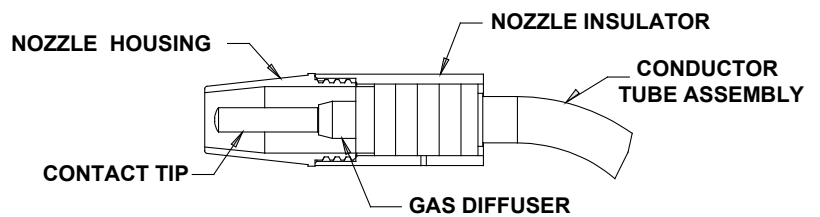

400 Amp Threaded Nozzle

24CT Series Nozzle — Use with 34CT (Stock No. 1340-1400) Nozzle Insulator

24CT Series Nozzle – 1/8” (3,2mm) Tip Recess

Bore Size “A”	Part No.	Stock No.
.375”-9,5mm	24CT-37-S	1240-1404
.500”-12,7mm	24CT-50-S	1240-1414
.625”-15,9mm	24CT-62-S	1240-1424
.750”-19,1mm	24CT-75-S	1240-1434

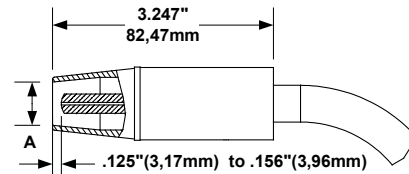

Note: Part No. 24CT-62-S (Stock No. 1240-1424) comes with all TAM400 amp series MIG Guns

24CT Series Nozzle – Tip Flush

Bore Size “A”	Part No.	Stock No.
.500”-12,7mm	24CT-50-F	1240-1412
.625”-15,9mm	24CT-62-F	1240-1422

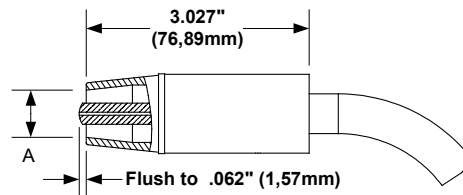

24CT Series Nozzle – 1/2”(12,7mm) Tip Recess

Bore Size “A”	Part No.	Stock No.
.625”-15,9mm	24CT-62-R	1240-1423
.750”-19,1mm	24CT-75-R	1240-1433

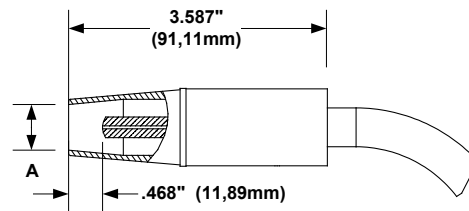

Front End Consumables For TAM and RA Series MIG Gun and Cable Assembly

500 Amp Threaded Nozzle

25CT Series Nozzle — Use with 35CT (Stock No. 1350-1400) Nozzle Insulator

25CT Series Nozzle – 1/8”(3,2mm) Tip Recess

Bore Size “A”	Part No.	Stock No.
.500”-12,7mm	25CT-50	1250-1410
.625”-15,9mm	25CT-62	1250-1420
.750”-19,1mm	25CT-75	1250-1430

Note: Part No. 25CT-62 (Stock No. 1250-1420) comes with all TAM500 amp series MIG Guns

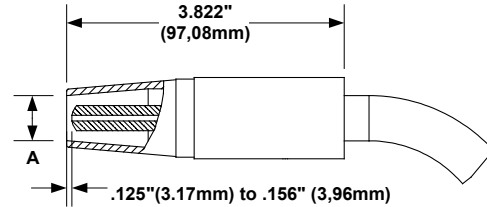

25CT Series Nozzle – Tip Flush

Bore Size “A”	Part No.	Stock No.
.625”-15,9mm	25CT-62-F	1250-1421
.750”-19,1mm	25CT-75-F	1250-1431

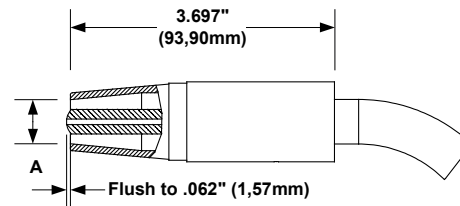

600 Amp Threaded Nozzle

26CT Series Nozzle — Use with 36CT (Stock No. 1360-1400) Nozzle Insulator

26CT Series Nozzle – 1/8”(3,2mm) Tip Recess

Bore Size “A”	Part No.	Stock No.
.625”-15,9mm	26CT-62	1260-1420
.750”-19,1mm	26CT-75	1260-1430

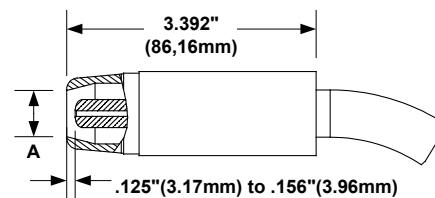

Front End Consumables For TAM and RA Series MIG Gun and Cable Assembly

Slip-On Style Nozzle

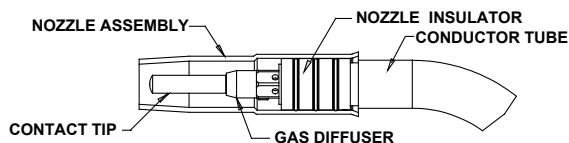

Standard Features:

- The Slip-On (adjustable) style nozzle assembly is made from a copper alloy tubing, which is cut to length and formed to size.
- Requires the use of a nozzle insulator that threads onto the torch body or conductor tube allowing the nozzle housing to slide. Nozzle insulator sold separately.
- Allows manual adjustment of tip and nozzle relationship within a given range.
- Use with 54, 55 and 56 series diffusers.

400 Amp Nozzle – Slip-On Type

24 Series Nozzle — Use with 34A (Stock No. 1340-1100) Nozzle Insulator

24 Series Slip-on Nozzle – Adjustable Recess to Projection

Bore Size "A"	Part No.	Stock No.
.500"-12,7mm	24A-50	1240-1110
.625"-15,9mm	24A-62	1240-1120
.750"-19,1mm	24A-75	1240-1130

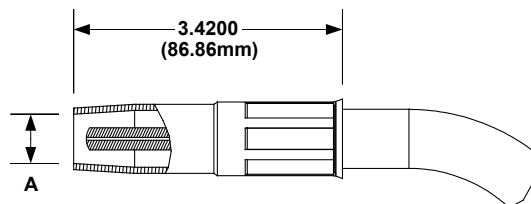

24 Series Slip-on Nozzle – Adjustable 1/8" (3,2mm) Tip Recess

Bore Size "A"	Part No.	Stock No.
.375"-9,5mm	24A-37-SS	1240-1101
.500"-12,7mm	24A-50-SS	1240-1111
.625"-15,9mm	24A-62-SS	1240-1121
.750"-19,1mm	24A-75-SS	1240-1131

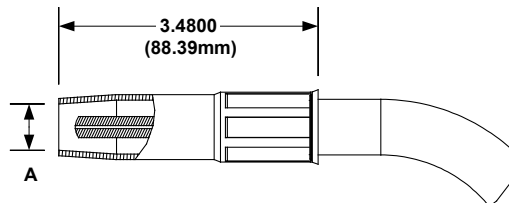

24 Series Slip-on Nozzle – Adjustable –Tapered 1/8" (3,2mm) Tip Recess

Bore Size "A"	Part No.	Stock No.
.375"-9,5mm	24AT-37-SS	1240-1301

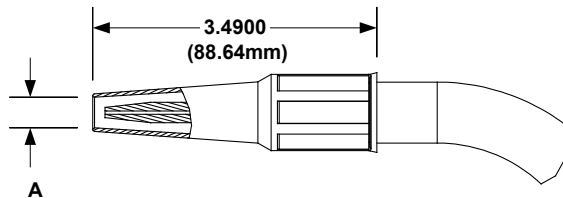

400 Amp Nozzle – Slip-On Type (Cont.)

24 Series Nozzle — Use with 34A (Stock No. 1340-1100) Nozzle Insulator

24 Series Slip-on Nozzle – Heavy Duty Adjustable – Recess to Projection

Bore Size "A"	Part No.	Stock No.
.500"-12,7mm	24AH-50	1240-1210
.625"-15,9mm	24AH-62	1240-1220
.750"-19,1mm	24AH-75	1240-1230

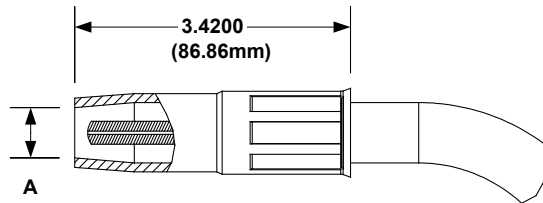

24 Series Slip-on Nozzle – Heavy Duty Adjustable – 1/8" (3,2mm) Tip Recess

Bore Size "A"	Part No.	Stock No.
.500"-12,7mm	24AH-50-SS	1240-1211
.625"-15,9mm	24AH-62-SS	1240-1221
.750"-15,9mm	24AH-75-SS	1240-1231

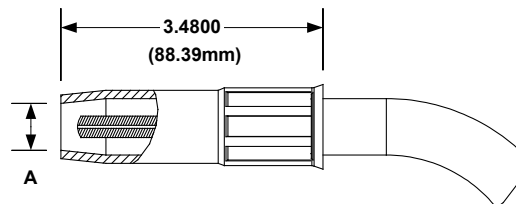

Front End Consumables For TAM and RA Series MIG Gun and Cable Assembly

HD Series Nozzles

Standard Features:

- Four different styles of HD threaded nozzles available.
- The HD (heavy duty) style nozzle assembly is made up of three (3) component parts:
 - Nozzle Housing — made from a copper alloy tubing, which is cut to length and formed to size.
 - Nozzle Insert — made from a solid brass alloy that is with internal threads allowing the nozzle assembly to be threaded onto the conductor tube.
 - Nozzle Insulator — made from G7 silicone material and provides the insulation needed from the conductor tube and nozzle housing.
- Use MS54 and HD54 series diffuser with this style of nozzle assembly.

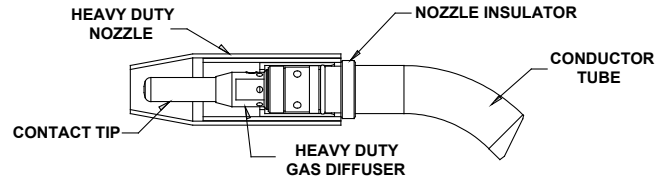

400 Amp Nozzle – Heavy Duty – Slip-On Type

**HD24 Series Nozzle – Adjustable
1/8" (3,2mm) Tip Recess**

Bore Size "A"	Part No.	Stock No.
.500"-12,7mm	HD24-50	1240-1240
.625"-15,9mm	HD24-62	1240-1241
.750"-19,1mm	HD24-75	1240-1242

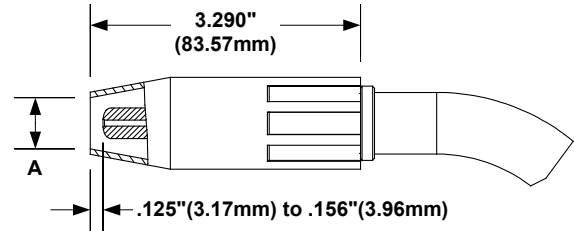

**HD24 Series – Adjustable
Tip Flush**

Bore Size "A"	Part No.	Stock No.
.500"-12,7mm	HD24-50-F	1240-1235
.625"-15,9mm	HD24-62-F	1240-1236
.750"-19,1mm	HD24-75-F	1240-1237

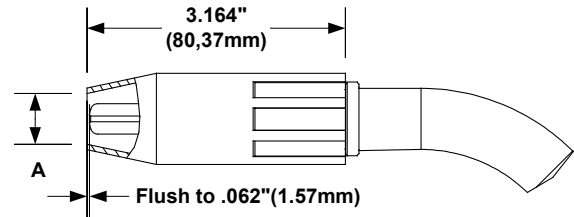

Front End Consumables For TAM and RA Series MIG Gun and Cable Assembly

Standard Features:

- Outer diameter of the HD24L series is smaller than HD24, however the wall thickness remains the same.
- Uses the MS54 and HD54 series diffuser with this style nozzle assembly.

**HD24L Series Nozzle – Adjustable
1/8" (3,2mm) Tip Recess**

Bore Size "A"	Part No.	Stock No.
.500"-12,7mm	HD24L-50	1240-1200
.625"-15,9mm	HD24L-62	1240-1201
.750"-19,1mm	HD24L-75	1240-1202

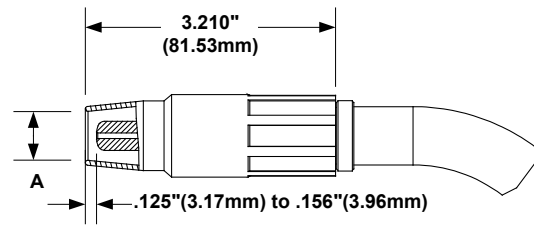

**HD24L Series – Adjustable
Tip Flush**

Bore Size "A"	Part No.	Stock No.
.500"-12,7mm	HD24L-50F	1240-1204
.625"-15,9mm	HD24L-62F	1240-1205
.750"-15,9mm	HD24L-75F	1240-1206

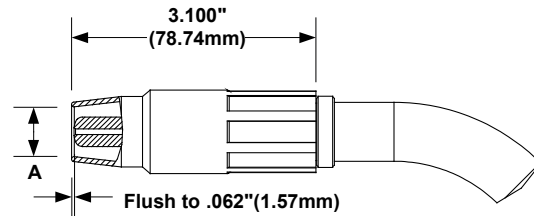

Front End Consumables For TAM and RA Series MIG Gun and Cable Assembly

Standard Features:

- The HD24LB and HD26B style nozzle assembly is made up of three (3) component parts:
 - Nozzle Housing — made from a red brass alloy tubing, which is cut to length and formed to size.
 - Nozzle Insert — made from a solid brass alloy with internal threads allowing the nozzle assembly to be threaded onto the conductor tube.
 - Nozzle Insulator — made from G7 silicone material and provides the insulation needed from the conductor tube and nozzle housing.
- Use diffuser series MS54 and HD54 with this style of nozzle assembly.

400 Amp Nozzle – Heavy Duty – Slip-On Type

**HD26B Series Nozzle – Adjustable
1/8" (3,2mm) Tip Recess**

Bore Size "A"	Part No.	Stock No.
.625"-15,9mm	HD26B-62	1260-1285
.750"-19,1mm	HD26B-75	1260-1286

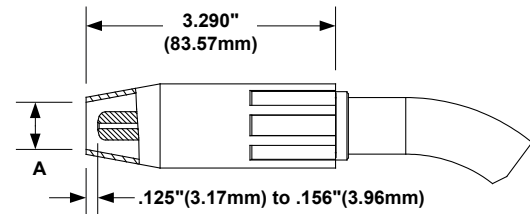

**HD24LB Series Nozzle – Adjustable
1/8" (3,2mm) Tip Recess**

Bore Size "A"	Part No.	Stock No.
.500"-12,7mm	HD24LB-50	1240-1215
.625"-15,9mm	HD24LB-62	1240-1216
.750"-19,1mm	HD24LB-75	1240-1217

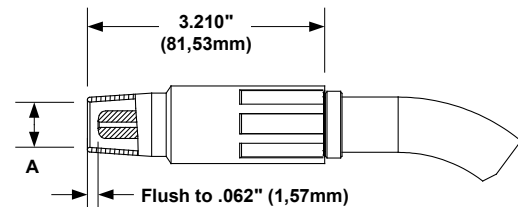

**HD24LB Series – Adjustable
Tip Flush**

Bore Size "A"	Part No.	Stock No.
.500"-12,7mm	HD24LB-50F	1240-1218
.625"-15,9mm	HD24LB-62F	1240-1219

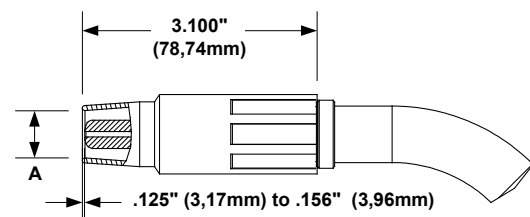

Front End Consumables For RA Series MIG Gun and Cable Assembly

400 Amp Nozzle – Eliminator® Style – Threaded

Standard Features:

- For use with RAEL64 series conductor tubes.
- Use diffuser EL54CT-SW or EL54CT-H with this style of nozzle assemblies.

EL24CT Series Nozzle – 1/8" (3,2mm) Tip Recess

Bore Size "A"	Part No.	Stock No.
.375"-9,5mm	EL24CT-37	1260-1650
.500"-12,7mm	EL24CT-50	1260-1651
.625"-15,9mm	EL24CT-62	1260-1652
.750"-19,1mm	EL24CT-75	1260-1653

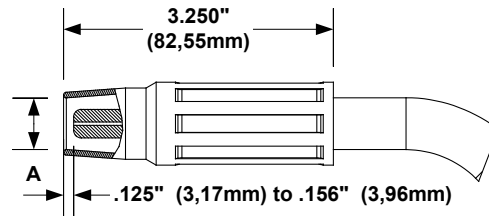

EL24CT Series Nozzle – Tip Flush

Bore Size "A"	Part No.	Stock No.
.500"-12,7mm	EL24CT-50F	1260-1666
.625"-15,9mm	EL24CT-62F	1260-1667

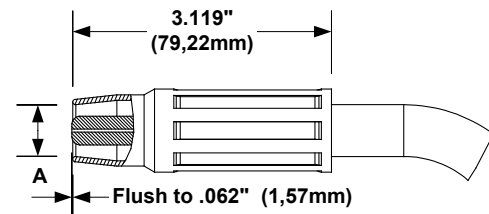

EL24CT Series Nozzle – Tip Protruded

Bore Size "A"	Part No.	Stock No.
.500"-12,7mm	EL24CT-50P	1260-1701
.625"-15,9mm	EL24CT-62P	1260-1702

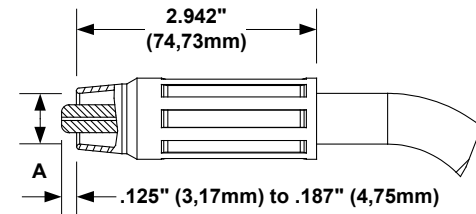

EL24CT Series Nozzle – 1/4" (6,4mm) Tip Recess

Bore Size "A"	Part No.	Stock No.
.500"-12,7mm	EL24CT-50R	1260-1681
.625"-15,9mm	EL24CT-62R	1260-1682

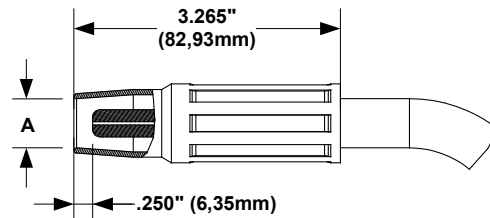

**EL24CT Series – Heavy Duty
1/8" (3,2mm) Tip Recess**

Bore Size "A"	Part No.	Stock No.
.625"-15,9mm	EL24CT-62H	1260-1657
.750"-15,9mm	EL24CT-75H	1260-1658

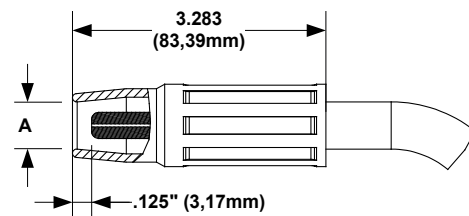

Front End Consumables For RA Series MIG Gun and Cable Assembly

400 Amp Nozzle – Eliminator® Style – Slip-On

Standard Features:

- For use with RAEL64 series conductor tubes.
- Use diffuser EL54-SW or EL54-H with this style of nozzle assemblies.

EL24I Series Nozzle – 1/8” (3,2mm) Tip Recess

Bore Size “A”	Part No.	Stock No.
.375”-9,5mm	EL24I-37	1260-1606
.500”-12,7mm	EL24I-50	1260-1607
.625”-15,9mm	EL24I-62	1260-1608
.750”-19,1mm	EL24I-75	1260-1609

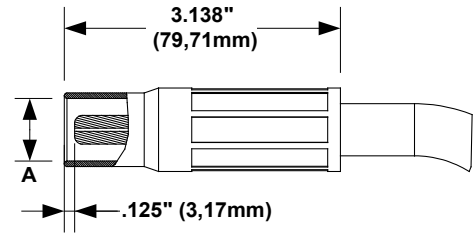

EL24I Series Nozzle – Tip Flush

Bore Size “A”	Part No.	Stock No.
.625”-15,9mm	EL24I-62F	1260-1618

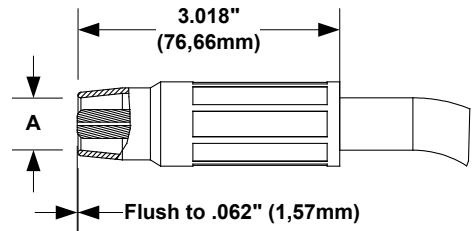

**EL24I Series Nozzle – Heavy Duty
1/8” (3,2mm) Tip Recess**

Bore Size “A”	Part No.	Stock No.
.625”-15,9mm	EL24I-62H	1260-1631
.750”-19,1mm	EL24I-75H	1260-1632

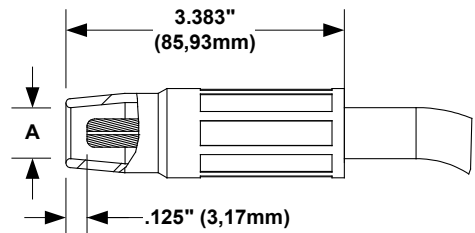

EL24CT Series – Heavy Duty – Tip Flush

Bore Size	Part No.	Stock No.
.625”-15,9mm	EL24I-62HF	1260-1641

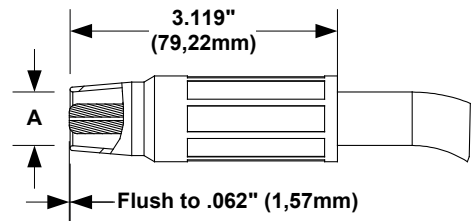

Fixed Automation Water-cooled Nozzle Assembly

Part No. 24WC-H (Stock No. 1240-1851) - 400 Amp

Part No. 25WC-H (Stock No. 1250-1851) - 500 Amp

Features:

- Provides water-cooled benefits to the front end of an air-cooled MIG gun.
- Ideal for welding application where heat build up on the standard air-cooled nozzle is extreme.
- Nozzle bore diameter is 3/4" (19,1mm)
- Easily installed on the TAM and RA Fixed Automation MIG guns or any style of conductor tube that has .625"x18 UNF-2B outside threads.
- Increase nozzle and front end consumable life.
- Supplied with nozzle, insulator, nut and water hoses (3 ft. - 91cm in length)

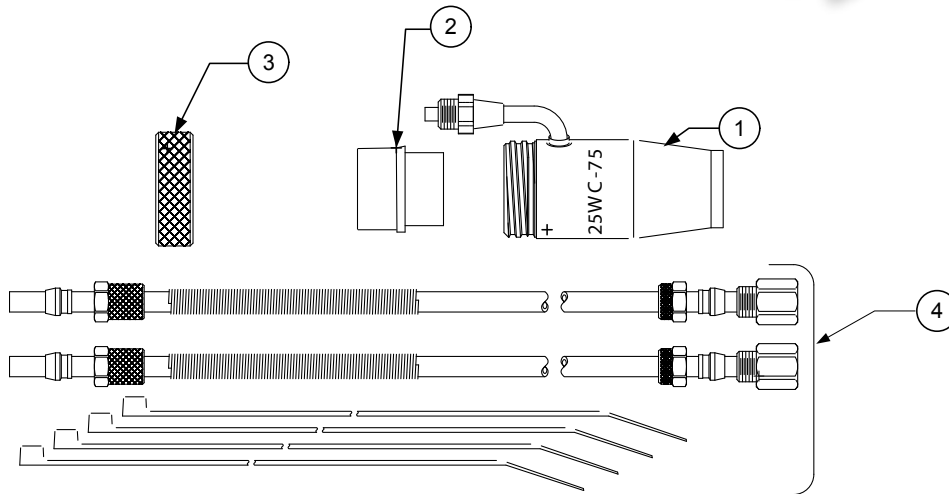

Replacement Parts

Item No.	Part No.	Stock No.	Description
1	25WC-75R	1250-1852	Water-cooled Nozzle Assembly
2	34WC	2040-2851	Nozzle Insulator - 400 Amp
2	35WC	2050-2860	Nozzle Insulator - 500 Amp
3	25SG-75-3	2050-2813	Nut
4	25WC-HK	2050-2852	Water-cooled Hose Kit (Includes 4 Nylon Ties)

Fixed Automation Submerged-Arc Nozzle Assembly

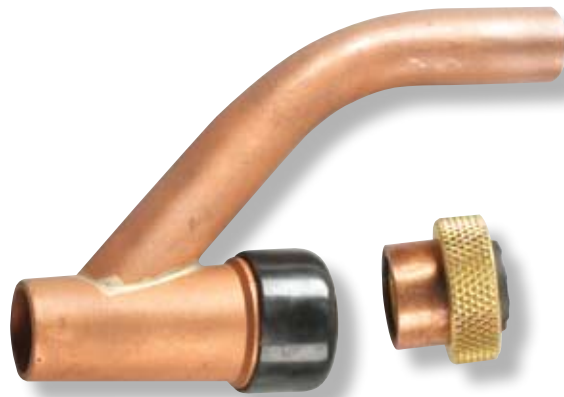

Part No. 25SA (Stock No. 1250-1810)

Features:

- Easily installed on the TAM and RA Fixed Automation MIG guns or any style of conductor tube that has .625"x18 UNF-2B outside threads.
- Feed tube is made from a 3/4" OD x 1/16" wall thickness copper tube.
- Nozzle bore diameter is 3/4" (19,1mm)

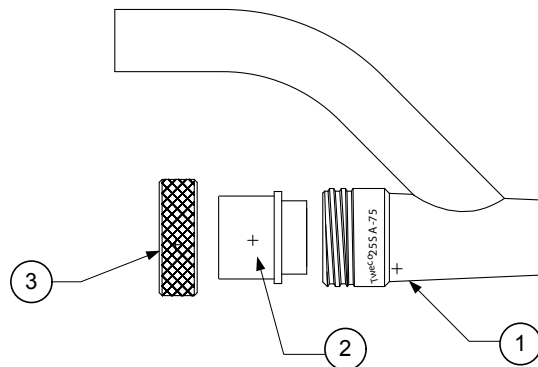

Replacement Parts

Item No.	Part No.	Stock No.	Description
1	25SA-75R	1250-1811	Sub-Arc Nozzle Assembly
2	35WC	2050-2860	Nozzle Insulator
3	25SG-75-3	2050-2813	Nut

Front End Consumables For TAM and RA Series MIG Gun and Cable Assembly

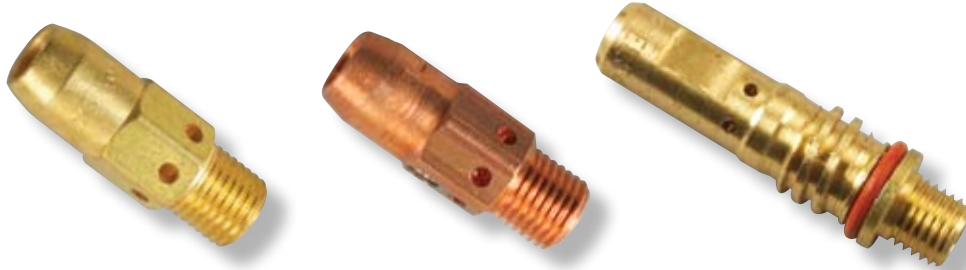

400 amp Diffusers

Part No.	Stock No.	
54A (Brass)	1540-1100	Use with standard contact tips and 44 series conduit .035" to 5/64" maximum
54P (Copper)	1540-1103	Use with standard contact tips and 44 series conduit .035" to 5/64" maximum
EL54CT-SW	1560-1116	Use with Eliminator® tips and CT nozzles — 44 series conduits .035" to 5/64" & 45 series conduits .035" to 1/16"
EL54CT-H	1560-1117	Use with Eliminator® tips and CT nozzles — 45 series conduits 5/64" to 1/8"

Note: All TAM & RA 400 amp series MIG Gun and Cable Assemblies are furnished with Part No. 54P



500 amp Diffusers

Part No.	Stock No.	
55SW	1550-1101	Use with standard contact tips and 45-3545, 45-116, and 45N-3545 series conduit
55	1550-1100	Use with standard contact tips and 45-564 and 45N-116 series conduit
55H	1550-1102	Use with standard contact tips and 45-564, 45N-116, 45H-332, 45H-764, and 45-18 series conduit
55S-SW	1550-1110	Use with 16S contact tips and 45-3545, 45-116, and 45N-3545 series conduit
55S-H	1550-1111	Use with 16S contact tips and 45-564, 45N-116, 45H-332, 45H-764, and 45-18 series conduit
55S-SWL	1550-1120	Use with standard contact tips and 45-564, 45N-116, 45H-332, 45H-764, and 45-18 series conduit
55S-HL	1550-1121	Use with standard contact tips and 45-564, 45N-116, 45H-332, 45H-764, and 45-18 series conduit

Note: All TAM500 amp series MIG Guns are furnished with Part No. 55SW (Stock No. 1550-1101)



600 amp Diffusers

Part No.	Stock No.	
56S-SW	1560-1100	Use with 16S contact tips and 45-3545, 45-116, and 45N-3545 series conduit
56S-H	1560-1101	Use with 16S contact tips and 45-564, 45N-116, 45H-332, 45H-764, and 45-18 series conduit

Note: All RA600 amp series MIG Guns are furnished with Part No. 56S-SW (Stock No. 1560-1100)

WRS400 & WRS600 Direct Plug Water-cooled Fixed Automation MIG Gun

This series of Automation MIG guns are offered without a cable assembly and are only offered for water-cooled welding applications. The water-cooled WRS MIG guns are rated at 100% duty cycle and can weld with wire diameters from .030” to 1/8”. The torch body uses a WRS64 and or WRS66 series conductor tube that are offered in various degrees of bend configurations. The WRS400 & WRS600 comes standard with a 180 degree conductor tubes. Other WRS Series conductor tubes are available and are sold separately. Refer to page 52.



Standard Features:

- WRS series offered in 400 and 600 amperes @ 100% duty cycle.
- MIG guns are furnished with the Tweco® rear connector plug, Part No. 176SH (Stock No. 2060-2177).
- Conductor tubes are keyed into the brass body of the assembly allowing a conductor tube to be replaced and the adjustments to be minimal when going from one tube configuration to another.
- Conductor tubes are locked in place by a threaded brass nut.
- 400 amp series comes standard with WC24-62 Nozzle, WC54A Gas Diffuser, and 14H-45 Contact Tip.
- 600 amp series comes standard with WC26-62 Nozzle, WC56A-SW Gas Diffuser, and 16S-116 Contact Tip.

WRS400 Series Direct Plug Water-cooled

Part No.	Stock No.	Description
WRS400-3545	3044-1320	Direct Plug with R44-3545 Conduit

WRS600 Series Direct Plug Water-cooled

Part No.	Stock No.	Description
WRS600-116	3064-1725	Direct Plug with R45-116 Conduit



Optional rear connector plug (Must be ordered separately)

Part No.	Stock No.	Description
R174MH	2060-2184	Miller® Rear Connector Plug (Use with R44 Series Conduit)
R176MH	2035-2109	Miller Rear Connector Plug (Use with R45 Series Conduit)
350-174H	2035-2110	Tweco Rear Connector Plug (Use with R44 Series Conduit)
350-174PH	2035-2172	Panasonic® Rear Connector Plug (Use with R44 Series Conduit)
QTR174LH	2086-2623	Lincoln® Rear Connector Plug (Use with R44 Series Conduit)
QTR176LH	2086-2624	Lincoln Rear Connector Plug (Use with R45 Series Conduit)

Miller is a registered trademark of Illinois Tool Works, Inc. Lincoln is a registered trademark of Lincoln Electric Co. Panasonic is a registered trademark of Matsushita Electric Industrial Co., Ltd. The afore mentioned registered trademarks are in no way affiliated with Tweco Robotics or Thermadyne Industries, Inc. Tweco is a registered trademark of Thermadyne Industries, Inc.

WRS600 Replacement Parts

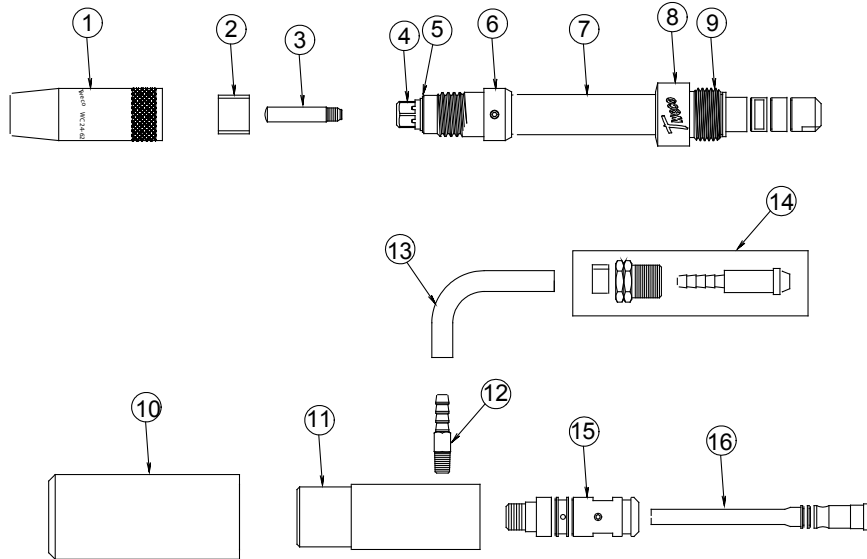

Item No.	Part No.	Stock No.	Description
1	—	—	Nozzle Assembly – Refer to Page 53 through 55
2	WC24-1	1244-1009	Spatter Shield – 400 Amp
	WC26-1	1264-1009	Spatter Shield – 600 Amp
3	—	—	Contact Tip – Refer to Page 56 through 61
4	—	—	Diffuser – Refer to Page 53
5	WC34-R	2044-1034	Pressure Ring – 400 Amp
	WC36-R	2064-1036	Pressure Ring – 600 Amp
NS	224S	2064-2059	O-Ring – 400 & 600 Amp
6	WCS34-H	1344-1844	Sealed Conductor Tube Housing – 400 Amp
	WCS36-H	1344-1145	Sealed Conductor Tube Housing – 600 Amp
7	—	—	Conductor Tube Assembly – Refer to Page 52
NS	224S	2064-2059	O-Ring – 400 & 600 Amp
8	WR6C	2066-2006	Conductor Tube Nut Cover
9	WR66-N	2066-2066	Conductor Tube Nut
10	WR600-H	2066-2601	Case – 400 & 600 Amp
11	WR600-106	2066-2107	Torch Block Assembly – 400 & 600 Amp
12	QTRW600-N	3044-1039	Water Hose Nipple
13	60957	N/A	Water Hose – Sold Per Ft.
14	WC35-5	1764-2140	Water Hose Fitting
15	176S-H	2060-2177	Tweco® Connector Plug - ***
	350-174H	2035-2110	Tweco Connector Plug (Uses R44 series Conduit)
	QTR176LH	2086-2624	Lincoln® Connector Plug (2.71" – 68,83mm OAL.)
	EL176LH	2060-2680	Lincoln Connector Plug (3.84" – 97,54mm OAL)
	QTR174LH	2086-2623	Lincoln Connector Plug (Uses R44 series Conduit)
	350-174PH	2035-2172	Panasonic® Connector Plug (Uses R44 series Conduit)
	R176MH	2060-2184	Miller® Connector Plug
	R174MH	2035-2109	Miller Connector Plug
	R175M-N045	2050-2181	Miller Plug Nipple, .045" (1,0mm) Wire (Use w/R176MH)
	R174M-N045	2040-2192	Miller Plug Nipple, .045" (1,0mm) Wire (Use w/R174MH)
	R175M-N116	2050-2182	Miller Plug Nipple, .062" (1,6mm) Wire (Use w/R176MH)
	R174M-N116	2040-2191	Miller Plug Nipple, .062" (1,6mm) Wire (Use w/R174MH)
16	—	—	Conduit (Refer to Page 62 - 63)

Miller is a registered trademark of Illinois Tool Works, Inc. Lincoln is a registered trademark of Lincoln Electric Co. Panasonic is a registered trademark of Matsushita Electric Industrial Co., Ltd. The afore mentioned registered trademarks are in no way affiliated with Tweco Robotics or Thermadyne Industries, Inc. Tweco is a registered trademark of Thermadyne Industries, Inc.

WRS Series Automation MIG Gun and Cable Assembly

This series of Automation MIG guns are offered with a cable assemblies and are for water-cooled welding applications.

Standard Features:

- Available in 400 and 600 amperes @ 100% duty cycle.
- Offered in lengths from 4ft. (1,22m) to 12ft. (4m).
- Mounting surface is the outer diameter of the 1-5/8" (41,28mm) plastic case.
- Seven different bend configuration conductor tubes are available to choose from in each amperage range. Note: WRS Series MIG Gun and Cable Assembly comes with a 22 degree conductor tube.
- Conductor tubes are keyed into the brass body of the assembly allowing a conductor tube to be replaced and the adjustments to be minimal when going from one tube configuration to another.
- 400 amp series comes standard with WC24-62 Nozzle, WC54A Gas Diffuser, and 14H-45 Contact Tip.
- 600 amp series comes standard with WC26-62 Nozzle, WC56A-SW Gas Diffuser, and 16S-116 Contact Tip.

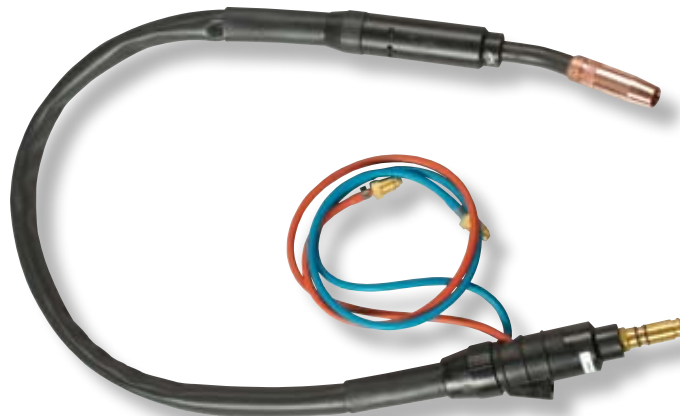

400 Amp Series

Part No.	Stock No.	Description
WRS404-3545	3044-1322	With 4ft. / 1,22m Cable Assembly
WRS406-3545	3044-1323	With 6ft. / 1,83m Cable Assembly
WRS408-3545	3044-1324	With 8 ft. / 2,44m Cable Assembly
WRS410-3545	3044-1325	With 10ft. / 3m Cable Assembly
WRS412-3545	3044-1326	With 12ft. / 4m Cable Assembly
WRS415-3545	3044-1327	With 15ft. / 5m Cable Assembly

Note: MIG Gun and Cable Assemblies are furnished with R45-3545 Conduit

600 Amp Series

Part No.	Stock No.	Description
WRS604-116	3064-1366	With 4ft. / 1,22m Cable Assembly
WRS606-116	3064-1367	With 6ft. / 1,83m Cable Assembly
WRS608-116	3064-1368	With 8 ft. / 2,44m Cable Assembly
WRS610-116	3064-1369	With 10ft. / 3m Cable Assembly
WRS612-116	3064-1370	With 12ft. / 4m Cable Assembly
WRS615-116	3064-1371	With 15ft. / 5m Cable Assembly

Note: MIG Gun and Cable Assemblies are furnished with R45-116 Conduit

WRS Series Replacement Parts

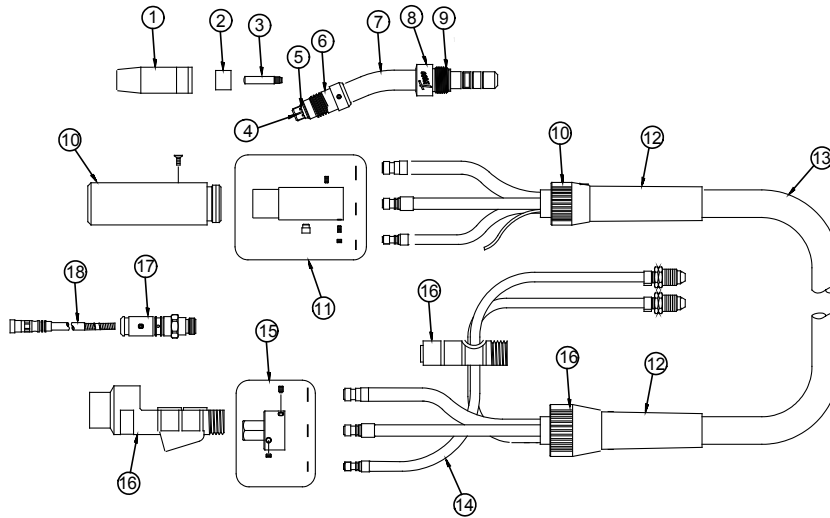

Item No.	Part No.	Stock No.	Description
1	—	—	Nozzle Assembly – Refer to Page 53 through 55
2	WC24-1	1244-1009	Spatter Shield – 400 Amp
	WC26-1	1264-1009	Spatter Shield – 600 Amp
3	—	—	Contact Tip – Refer to Page 56 through 61
4	—	—	Diffuser – Refer to Page 53
5	WC34-R	2044-1034	Pressure Ring – 400 Amp
	WC36-R	2064-1036	Pressure Ring – 600 Amp
NS	224S	2064-2059	O-Ring – 400 & 600 Amp
6	WCS34-H	1344-1844	Sealed Conductor Tube Housing – 400 Amp
	WCS36-H	1344-1145	Sealed Conductor Tube Housing – 600 Amp
7	—	—	Conductor Tube Assembly – Refer to Page 52
NS	224S	2064-2059	O-Ring – 400 & 600 Amp
8	WR6C	2066-2006	Conductor Tube Nut Cover
9	WR66-N	2066-2066	Conductor Tube Nut
10	WR6H	2066-2600	Case With Strain Relief Cap
11	WR106	2066-2106	Torch Block Assembly
12	WC146-6	2064-2146	Strain Relief – Front
13	WC600-4	1764-2107	Cable Assembly With Fittings – 4ft. (1,22m)
	WC600-6	1764-2108	Cable Assembly With Fittings – 6ft. (1,83m)
	WC600-8	1764-2109	Cable Assembly With Fittings – 8ft. (2,44m)
	WC600-10	1764-2101	Cable Assembly With Fittings – 10ft. (3m)
	WC600-12	1764-2102	Cable Assembly With Fittings – 12ft. (4m)
	WC600-15	1764-2103	Cable Assembly With Fittings – 15ft. (5m)
NS	WC604-WH	1764-2137	Water Inlet Hose – 4ft. (1,22m)
	WC606-WH	1764-2138	Water Inlet Hose – 6ft. (1,83m)
	WC608-WH	1764-2139	Water Inlet Hose – 8ft. (2,44m)

Item No.	Part No.	Stock No.	Description
	WC610-WH	1764-2131	Water Inlet Hose – 10ft. (3m)
	WC612-WH	1764-2132	Water Inlet Hose – 12ft. (4m)
	WC615-WH	1764-2133	Water Inlet Hose – 15ft. (5m)
NS	WC604-PC	1764-2117	Power Cable Assembly – 4ft. (1,22m)
	WC606-PC	1764-2118	Power Cable Assembly – 6ft. (1,83m)
	WC608-PC	1764-2119	Power Cable Assembly – 8ft. (2,44m)
	WC610-PC	1764-2111	Power Cable Assembly – 10ft. (3m)
	WC612-PC	1764-2112	Power Cable Assembly – 12ft. (4m)
	WC615-PC	1764-2113	Power Cable Assembly – 15ft. (5m)
NS	WC604-GH	1764-2127	Gas Hose Assembly – 4ft. (1,22m)
	WC606-GH	1764-2128	Gas Hose Assembly – 6ft. (1,83m)
	WC608-GH	1764-2129	Gas Hose Assembly – 8ft. (2,44m)
	WC610-GH	1764-2121	Gas Hose Assembly – 10ft. (3m)
	WC612-GH	1764-2122	Gas Hose Assembly – 12ft. (4m)
	WC615-GH	1764-2123	Gas Hose Assembly – 15ft. (5m)
NS	400LK-J	2044-2100	Outer jacket – Sold Per Ft.
14	WC603-WH	1764-2130	Outlet Water Hose – 3 ft. (900mm)
15	WC6-170H	2064-2171	Rear Connector Block Assembly
NS	45B	2050-2045	O-Ring – Front & Rear Block – Power Cable
NS	46B	2062-2046	O-Ring – Front & Rear Block – Gas Hose
NS	35-40-1	2000-2040	O-Ring – Front & Rear Block – Water Hose
16	WR6C	2064-2006	Rear Case Assembly
17	350-174H	2035-2110	Connector Plug Assembly – 400 Amp - Tweco®
	176SH	2066-2177	Connector Plug Assembly – 600 Amp - Tweco
	350-174PH	2035-2172	Panasonic® Connector Plug (Uses R44 series Conduit)
	R176MH	2060-2184	Miller® Connector Plug
	R174MH	2035-2109	Miller Connector Plug
	R175M-N045	2050-2181	Miller Plug Nipple, .045" (1,0mm) Wire (Use w/R176MH)
	R174M-N045	2040-2192	Miller Plug Nipple, .045" (1,0mm) Wire (Use w/R174MH)
	R175M-N116	2050-2182	Miller Plug Nipple, .062" (1,6mm) Wire (Use w/R176MH)
	R174M-N116	2040-2191	Miller Plug Nipple, .062" (1,6mm) Wire (Use w/R174MH)
18	—	—	Conduit (Refer to Page 62 - 63)

Miller is a registered trademark of Illinois Tool Works, Inc. Panasonic is a registered trademark of Matsushita Electric Industrial Co., Ltd. The afore mentioned registered trademarks are in no way affiliated with Tweco Robotics or Thermadyne Industries, Inc. Tweco is a registered trademark of Thermadyne Industries, Inc.

WRS Series 400 & 600 amp Conductor Tube



The WRS series conductor tube is a rugged and fully insulated design. The sealed conductor tube housing assembly contains a thermally conductive insulator to draw the heat out of the nozzle. A neoprene hose insulates the inner tube assembly from the grounded work surface. The inner tube is constructed from a brass and copper duplex style extruded tube. The front end of the brazed inner tube assembly is a tapered copper front to fit between itself and the nozzle housing.

The conductor tubes are positively located into the torch body a key slot machined on the rear portion of the conductor tube. A steel pin located inside the brass block assembly is used to locate the conductor tube in place. This ensures the proper relationship with the torch body and mounting fixture.

The water-cooled feature of the torch allows the water to flow through the torch body into the conductor tube. The cold water flows to the front of the conductor tube where it circulates around the nozzle area of the torch drawing heat out of the gas diffuser, contact tip and nozzle. The water then returns back down the power cable of the torch towards the water circulator.

Standard Features:

- Different bend configurations are available for each amperage range of conductor tubes.
- Conductor tubes are keyed and held in place by a brass threaded nut that presses the conductor tube in place within the torch block assembly.

WRS64 Series (400 amp) Conductor Tube

	22°	45°	60°	180°	22°L	45°L	180°L
Part No.	WRS64-22	WRS64-45	WRS64-60	WRS64-180	WRS64-22L	WRS64-45L	WRS64-180L
Stock No.	1646-1604	1646-1605	1646-1606	1646-1607	1646-1625	1646-1626	1646-1635

WRS66 Series (600 amp) Conductor Tube

	22°	45°	60°	180°	22°L	45°L	180°L
Part No.	WRS66-22	WRS66-45	WRS66-60	WRS66-180	WRS66-22L	WRS66-45L	WRS66-180L
Stock No.	1663-1610	1663-1612	1663-1614	1663-1617	1663-1611	1663-1613	1663-1618

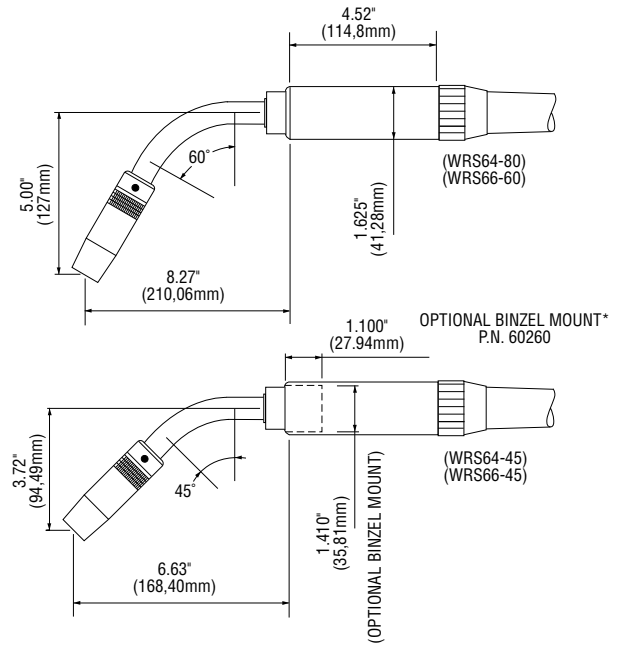
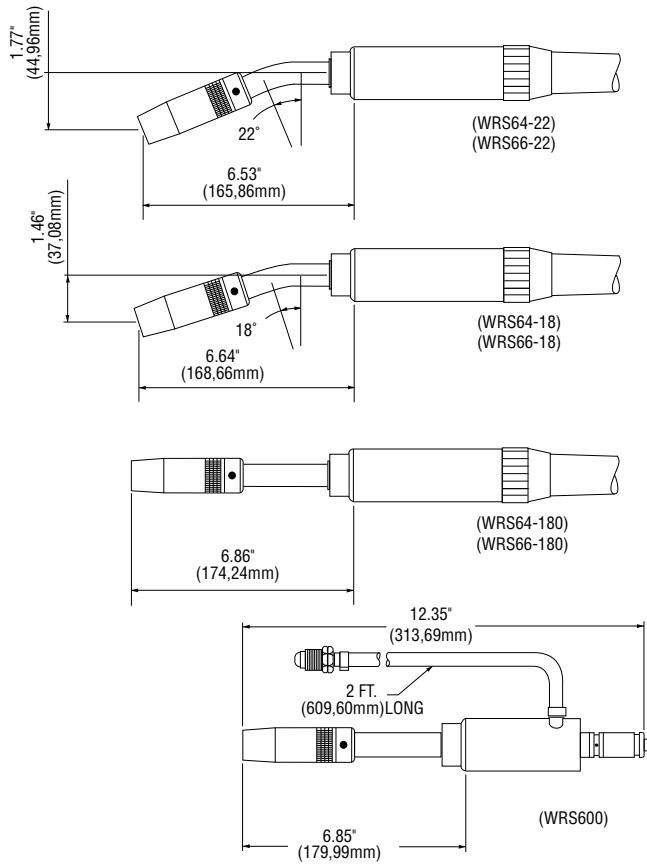

Front End Consumables For WRS Series Conductor Tubes

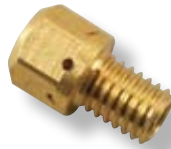

400 amp Diffusers

Part No.	Stock No.	
WC54A	1544-1141	Use with 44 series conduits .030" to 5/64"

Note: 400 ampere MIG Gun and Cable Assemblies are furnished with WC54A diffuser.



600 amp Diffusers

Part No.	Stock No.	
WC56A-SW	1564-1145	Use with 45 series conduits .035" to 1/16"
WC56A	1564-1143	Use with 45 series conduits 5/64" hard wire & 1/16" AL wire conduits
WC56A-H	1564-1144	Use with 45 series conduits 3/32" to 1/8"

Note: 600 ampere MIG Gun and Cable Assemblies are furnished with WC56A-SW diffuser.

400 Amp Water-cooled Nozzle Assembly

Standard Features:

- The nozzle housing is machined from a solid copper alloy bar that assures consistent dimensional stability and an efficient dissipation of heat.
- A nozzle insulator — made from G7 silicone material and provides the insulation needed from the conductor tube and nozzle is furnished.

WC24 Series – Standard Tip Recess — Use with WC24-1 (Stock No. 1244-1009) Nozzle Insulator .125" (3,18mm)

Bore Size "A"	Part No.	Stock No.
.500"-12,7mm	WC24-50	1244-1110
.625"-15,9mm	WC24-62	1244-1120
.750"-19,1mm	WC24-75	1244-1130

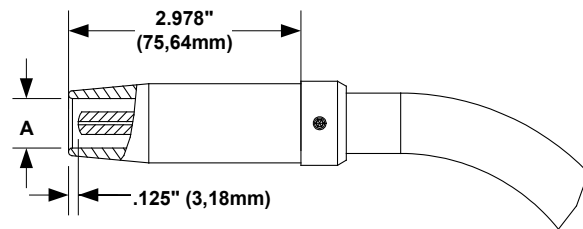

WC24Series Nozzle - Flush Tip Recess — Use with WC24-1 (Stock No. 1244-1009) Nozzle Insulator Flush to .062" (1,57mm)

Bore Size "A"	Part No.	Stock No.
.500"-12,7mm	WC24-50F	1244-1112
.625"-15,9mm	WC24-62F	1244-1122

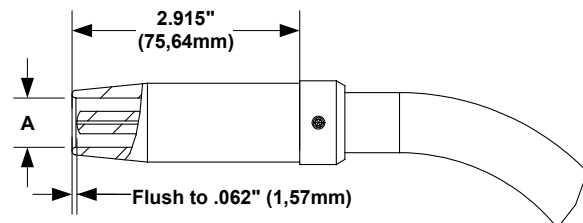

600 Amp Water-cooled Nozzle Assembly

WC26 Series – Standard Tip Recess — Use with WC26-1 (Stock No. 1264-1009) Nozzle Insulator .125" (3,18mm)

Bore Size "A"	Part No.	Stock No.
.625"-15,9mm	WC26-62	1264-1120
.750"-19,1mm	WC26-75	1264-1130

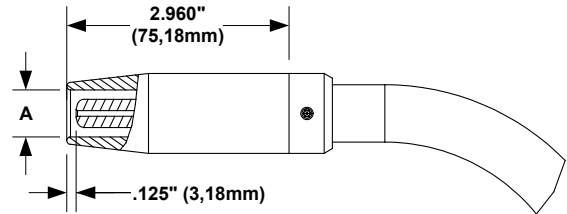

WC26 Series Nozzle – Flush Tip Recess — Use with WC26-1 (Stock No. 1264-1009) Nozzle Insulator Flush to .062" (1,57mm)

Bore Size "A"	Part No.	Stock No.
.625"-15,9mm	WC26-62F	1264-1122
.750"-19,1mm	WC26-75F	1264-1132

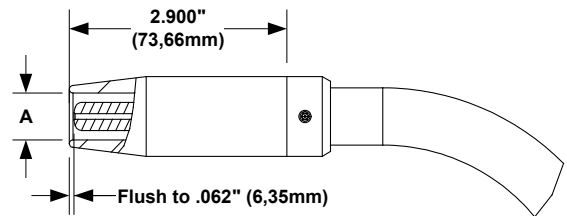

WC26 Series Nozzle – Tip Recess — Use with WC26-1 (Stock No. 1264-1009) Nozzle Insulator .250" (6,35mm)

Bore Size "A"	Part No.	Stock No.
.625"-15,9mm	WC26-62R	1264-1123
.750"-19,1mm	WC26-75R	1264-1133

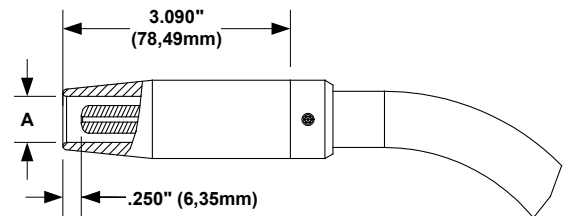

600 Amp Water-cooled Nozzle Assembly

**WC26EL — Eliminator® Series – Standard Tip
Recess — Use with WC26-1 (Stock No. 1264-1009)
Nozzle Insulator .125" (3,18mm)**

Bore Size "A"	Part No.	Stock No.
.500"-12,7mm	WC26-50EL	1262-1031
.625"-15,9mm	WC26-62EL	1262-1032
.750"-19,1mm	WC26-75EL	1262-1033

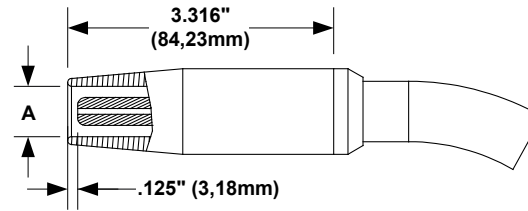

**WC26EL — Eliminator Series Nozzle – Flush Tip
Recess — Use with WC26-1 (Stock No. 1264-1009)
Nozzle Insulator Flush to .062" (1,57mm)**

Bore Size "A"	Part No.	Stock No.
.625"-15,9mm	WC26-62ELF	1262-1037
.750"-19,1mm	WC26-75ELF	1262-1038

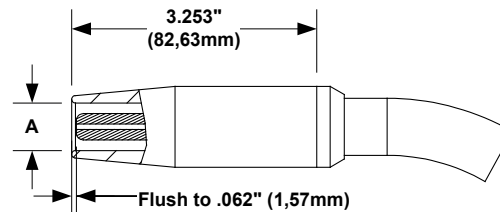

**WC26EL — Eliminator Series Nozzle – Tip Recess
— Use with WC26-1 (Stock No. 1264-1009)
Nozzle Insulator .250" (6,35mm)**

Bore Size	Part No.	Stock No.
.625"-15,9mm	WC26-62ELR	1262-1041
.750"-19,1mm	WC26-75ELR	1262-1042

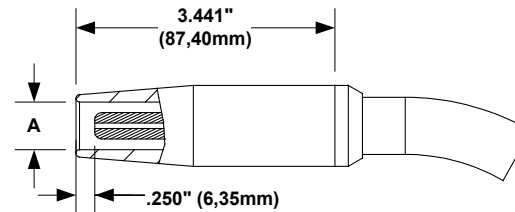

Standard Contact Tips - 14 Series

14 Series Tips Wire Size	Tip I.D. +/- .003"	Part No. Stock No.
.023" / 0,58mm	.031" / 0,79mm	14-23 1140-1100
.030" / 0,76mm	.038" / 0,97mm	14-30 1140-1101
.035" / 0,89mm	.044" / 1,12mm	14-35 1140-1102
.040" / 1,02mm	.048" / 1,22mm	14-40 1140-1103
.045" / 1,14mm	.054" / 1,37mm	14-45 1140-1104
.052" / 1,32mm	.064" / 1,63mm	14-52 1140-1105
1/16" / 1,6mm	.073" / 1,85mm	14-116 1140-1106
5/64" / 1,98mm	.090" / 2,29mm	14-564 1140-1109
3/64" / 1,19mm	.059" / 1,50mm	14A-364 1140-1113

14H Series Tips Wire Size	Tip I.D. +/- .003"	Part No. Stock No.
.035" / 0,89mm	.044" / 1,12mm	14H-35 1140-1202
.040" / 1,02mm	.048" / 1,22mm	14H-40 1140-1203
.045" / 1,14mm	.054" / 1,37mm	14H-45 1140-1204
.052" / 1,32mm	.064" / 1,32mm	14H-52 1140-1205
1/16" / 1,6mm	.073" / 1,85mm	14H-116 1140-1206
5/64" / 1,98mm	.090" / 2,29mm	14H-564 1140-1209
3/64" / 1,19mm	.059" / 1,50mm	14AH-364 1140-1213
1/16" / 1,6mm	.082" / 2,08mm	14AH-116 1140-1214

* Use 14AH Series contact tips with aluminum wire.

14T Series Tips Wire Size	Tip I.D. +/- .003"	Part No. Stock No.
.023" / 0,58mm	.031" / 0,79mm	14T-23 1140-1300
.030" / 0,76mm	.038" / 0,97mm	14T-30 1140-1301
.035" / 0,89mm	.044" / 1,12mm	14T-35 1140-1302
.040" / 1,02mm	.048" / 1,22mm	14T-40 1140-1303
.045" / 1,14mm	.054" / 1,37mm	14T-45 1140-1304
.052" / 1,32mm	.064" / 1,63mm	14T-52 1140-1305
1/16" / 1,6mm	.073" / 1,85mm	14T-116 1140-1306

Standard Contact Tips - 15 Series

15H Series Tips Wire Size	Tip I.D. +/- .003"	Part No. Stock No.
.035" / 0,89mm	.044" / 1,12mm	15H-35 1150-1202
.045" / 1,14mm	.054" / 1,37mm	15H-45 1150-1204
.052" / 1,32mm	.064" / 1,63mm	15H-52 1150-1205
1/16" / 1,6mm	.073" / 1,85mm	15H-116 1150-1206
5/64" / 1,98mm	.090" / 2,29mm	15H-564 1150-1209
1/8" / 3,18mm	.144" / 3,66mm	15H-18 1150-1212

15HFC Series Tips Wire Size	Tip I.D. +/- .003"	Part No. Stock No.
.035" / 0,89mm	.044" / 1,12mm	15HFC-35 1150-1252
.045" / 1,14mm	.054" / 1,37mm	15HFC-45 1150-1254
.052" / 1,32mm	.064" / 1,32mm	15HFC-52 1150-1255
1/16" / 1,6mm	.073" / 1,85mm	15HFC-116 1150-1256
5/64" / 1,98mm	.090" / 2,29mm	15HFC-564 1150-1259
3/32" / 2,38mm	.106" / 2,69mm	15HFC-332 1150-1260
7/64" / 2,78mm	.120" / 3,05mm	15HFC-764 1150-1261
1/8" / 3,18mm	.144" / 3,66mm	15HFC-18 1150-1262

15AH Series Tips Wire Size	Tip I.D. +/- .003"	Part No. Stock No.
3/64" / 1,19mm	.059" / 1,50mm	15AH-364 1150-1213
1/16" / 1,6mm	.082" / 2,08mm	15AH-116 1150-1214

Standard Contact Tips - 16 Series

16S Series Tips Wire Size	Tip I.D. +/- .003"	Part No. Stock No.
.035" / 0,89mm	.044" / 1,12mm	16S-35 1160-1102
.040" / 1,02mm	.048" / 1,22mm	16S-40 1160-1103
.045" / 1,14mm	.054" / 1,37mm	16S-45 1160-1104
.052" / 1,32mm	.064" / 1,63mm	16S-52 1160-1105
1/16" / 1,6mm	.073" / 1,85mm	16S-116 1160-1106
5/64" / 1,98mm	.090" / 2,29mm	16S-564 1160-1109
3/32" / 1,19mm	.106" / 2,69mm	16S-332 1160-1110
7/64" / 2,78mm	.120" / 3,05mm	16S-764 1160-1111
1/8" / 3,18mm	.144" / 3,66mm	16S-18 1160-1112

16AS Series Tips Wire Size	Tip I.D. +/- .003"	Part No. Stock No.
3/64" / 1,19mm	.059" / 1,50mm	16AS-364 1160-1113
1/16" / 1,6mm	.082" / 2,08mm	16AS-116 1160-1114

The premium quality Copper-Silver material used in the Tweco® Robotics “RS” series tips:

- Delivers better conductivity – resistance properties
- Reduces micro arcing on the inside diameter surface
- Offers increased tip life
- Delivers significant performance advantage over conventional contact tips.



The “RS” series contact tips are offered in both threaded and cam styles - refer to selection listed below.

Eliminator® Style Contact Tips

11 Series Tips Wire Size	Tip I.D. +/- .002"	Part No. Stock No.
.035" / 0,9mm	.041" / 1,04mm	11RS-35 1110-1225
.045" / 1,2mm	.051" / 1,29mm	11RS-45 1110-1226



14 Series Tips Wire Size	Tip I.D. +/- .002"	Part No. Stock No.
.035" / 0,9mm	.041" / 1,04mm	14RS-35 1140-1475
.045" / 1,2mm	.054" / 1,37mm	14RS-45C 1140-1480
.052" / 1,3mm	.058" / 1,47mm	14RS-52 1140-1478

14 Series Tips Wire Size	Tip I.D. +/- .002"	Part No. Stock No.
.035" / 0,9mm	.041" / 1,04mm	14RST-35 1140-1482
.045" / 1,2mm	.054" / 1,37mm	14RST-45C 1140-1487
.052" / 1,3mm	.058" / 1,47mm	14RST-52 1140-1485

16 Series Tips Wire Size	Tip I.D. +/- .002"	Part No. Stock No.
.035" / 0,9mm	.041" / 1,04mm	16RS-35 1160-1468
.045" / 1,2mm	.051" / 1,29mm	16RS-45 1160-1470
.045" / 1,2mm	.054" / 1,37mm	16RS-45C 1160-1473
.052" / 1,3mm	.058" / 1,47mm	16RS-52 1160-1471
1/16" / 1,6mm	.073" / 1,85mm	16RS-116 1160-1472

16 Series Tips Wire Size	Tip I.D. +/- .002"	Part No. Stock No.
.035" / 0,9mm	.041" / 1,04mm	16RST-35 1160-1475
.045" / 1,2mm	.051" / 1,29mm	16RST-45 1160-1477
.045" / 1,2mm	.054" / 1,37mm	16RST-45C 1160-1480
.052" / 1,3mm	.058" / 1,47mm	16RST-52 1160-1478
1/16" / 1,6mm	.073" / 1,85mm	16RST-116 1160-1479

Eliminator® Style Contact Tips

EL11 Series Standard Tips Wire Size	Tip I.D. +/- .002"	Part No. Stock No.
.023" / 0,6mm	.031" / 0,79mm	EL11-23 1140-1175
.035" / 0,9mm	.041" / 1,04mm	EL11-30 1140-1176
.040" / 1,0mm	.046" / 1,16mm	EL11-35 1140-1177
.045" / 1,2mm	.051" / 1,29mm	EL11-40 1140-1178
.045" / 1,2mm	.054" / 1,37mm	EL11-45 1140-1179



EL16RS-45

RS Series Copper / Silver Eliminator Contact Tips

EL16 Series Tips Wire Size	Tip I.D. +/- .002"	Part No. Stock No.
.035" / 0,9mm	.041" / 1,04mm	EL16RS-35 1160-1740
.045" / 1,2mm	.051" / 1,29mm	EL16RS-45 1160-1742
.045" / 1,2mm	.054" / 1,37mm	EL16RS-45C 1160-1745
1/16" / 1,6mm	.073" / 1,85mm	EL16RS-116 1160-1744

EL16 Series Tips Wire Size	Tip I.D. +/- .002"	Part No. Stock No.
.035" / 0,9mm	.041" / 1,04mm	EL16RST-35 1160-1712
.045" / 1,2mm	.051" / 1,29mm	EL16RST-45 1160-1714
.045" / 1,2mm	.054" / 1,37mm	EL16RST-45C 1160-1717
1/16" / 1,6mm	.073" / 1,85mm	EL16RST-116 1160-1716

Chrome Zirconium - Copper “RZ” Contact Tips

The chrome-zirconium copper material used in the “RZ” series contact tips is harder than the pure copper material which increases the wear resistance properties. The “RZ” series contact tips are offered in the threaded style only.



16RZT-45



14RZ-45

RZ Series Chrome Zirconium Contact Tips

14 Series Tips Wire Size	Tip I.D. +/- .002"	Part No. Stock No.
.035" / 0,9mm	.041" / 1,04mm	14RZ-35 1140-1430
.045" / 1,2mm	.051" / 1,29mm	14RZ-45 1140-1432
.052" / 1,3mm	.058" / 1,47mm	14RZ-52 1140-1433

14 Series Tips Wire Size	Tip I.D. +/- .002"	Part No. Stock No.
.035" / 0,9mm	.041" / 1,04mm	14RZT-35 1140-1440
.045" / 1,2mm	.051" / 1,29mm	14RZT-45 1140-1442
.052" / 1,3mm	.058" / 1,47mm	14RZT-52 1140-1443

16 Series Tips Wire Size	Tip I.D. +/- .002"	Part No. Stock No.
.035" / 0,9mm	.041" / 1,04mm	16RZ-35 1160-1180
.045" / 1,2mm	.051" / 1,29mm	16RZ-45 1160-1182
.052" / 1,3mm	.058" / 1,47mm	16RZ-52 1160-1183

16 Series Tips Wire Size	Tip I.D. +/- .002"	Part No. Stock No.
.035" / 0,9mm	.041" / 1,04mm	16RZT-35 1160-1190
.045" / 1,2mm	.051" / 1,29mm	16RZT-45 1160-1192
.052" / 1,3mm	.058" / 1,47mm	16RZT-52 1160-1193

Robotic/Automation Conduits Liners

Standard Features:

- Tapered lead in angle on the machined conduit stop making the transition of the welding wire into the MIG gun smoother.
- Tin/zinc plated wire.

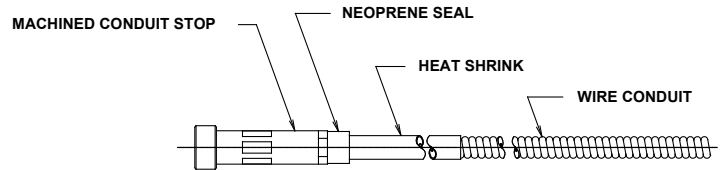

R44 Series Conduits

(Steel Welding Wire)

Wire Size	Part No. Stock No.
.035" / .045" 0,9mm / 1,2mm	R44-3545-1 1440-1223
.035" / .045" 0,9mm / 1,2mm	R44-3545-4 1440-1224
.035" / .045" 0,9mm / 1,2mm	R44-3545-8 1440-1225
.035" / .045" 0,9mm / 1,2mm	R44-3545-15 1440-1226
.052" / 1/16" 1,53mm / 1,6mm	R44-116-1 1440-1228
.052" / 1/16" 1,53mm / 1,6mm	R44-116-4 1440-1229
.052" / 1/16" 1,53mm / 1,6mm	R44-116-8 1440-1230
.052" / 1/16" 1,53mm / 1,6mm	R44-116-15 1440-1231

(Aluminum Welding Wire)

Wire Size	Part No. Stock No.
.035" / .045" 0,9mm / 1,2mm	R44WN-3545-4 1440-1040
.035" / .045" 0,9mm / 1,2mm	R44WN-3545-8 1440-1041
.035" / .045" 0,9mm / 1,2mm	R44WN-3545-15 1440-1042
1/16" 1,6mm	R44WN-116-8 1440-1046
1/16" 1,6mm	R44WN-116-15 1440-1047

R45 Series Conduits

Wire Size	Part No. Stock No.
.035" / .045" 0,9mm / 1,2mm	R45-3545-1 1450-1023
.035" / .045" 0,9mm / 1,2mm	R45-3545-4 1450-1024
.035" / .045" 0,9mm / 1,2mm	R45-3545-8 1450-1025
.035" / .045" 0,9mm / 1,2mm	R45-3545-15 1450-1026
.052" / 1/16" 1,53mm / 1,6mm	R45-116-1 1450-1028
.052" / 1/16" 1,53mm / 1,6mm	R45-116-4 1450-1029
.052" / 1/16" 1,53mm / 1,6mm	R45-116-8 1450-1030
.052" / 1/16" 1,53mm / 1,6mm	R45-116-15 1450-1031

Wire Size	Part No. Stock No.
.035" / .045" 0,9mm / 1,2mm	R45WN-3545-4 1450-1041
.035" / .045" 0,9mm / 1,2mm	R45WN-3545-8 1450-1042
.035" / .045" 0,9mm / 1,2mm	R45WN-3545-15 1450-1043
1/16" 1,6mm	R45WN-116-8 1450-1044
1/16" 1,6mm	R45WN-116-15 1450-1045

Note: R44 series conduits are shipped with all Euro-Kwik Torch Bodies and Cable Assemblies

"WN" = Wire Nylon Wrapped

Bronze Jump Liner

Part No. AWC44-116 (Stock No. 1644-1085)

The use of a jump liner improves arc starts and provides an improved current transfer between the contact tip and aluminum wire. The jump liner can also be used for wear issues found with the liner inside the conductor tube area when using stainless steel wires.



44 Series Conduits
(Steel Welding Wire)

Wire Size	Part No. Stock No.
.035" / .045" 0,9mm / 1,2mm	44-3545-15 1440-1103
.052" / 1/16" 1,53mm / 1,6mm	44-116-15 1440-1113
.052" / 1/16" 1,53mm / 1,6mm	44-116-25 1440-1115
5/64" 2,0mm	44-564-15 1440-1123
5/64" 2,0mm	44-564-25 1440-1125
3/32" 2,4mm	N/A
7/64" 2,8mm	N/A
1/8" 3,2mm	N/A

45 Series Conduits

Wire Size	Part No. Stock No.
.035" / .045" 0,9mm / 1,2mm	45-3545-15 1450-1103
.052" / 1/16" 1,53mm / 1,6mm	45-116-15 1450-1113
.052" / 1/16" 1,53mm / 1,6mm	45-116-25 1450-1115
5/64" 2,0mm	45-564-15 1450-1123
5/64" 2,0mm	45-564-25 1450-1125
3/32" 2,4mm	45H-332-15 1450-1133
7/64" 2,8mm	45H-764-15 1450-1143
1/8" 3,2mm	45-18-15 1450-1153

Tweco® Robotics offers an ideal holding fixture, TJ-2 TRI-JUST, (Stock No. 3500-1100), that provides the means to locate and hold your MIG gun in place.

Standard Features:

- Light weight and durable.
- All parts are machined from aluminum bar stock and or aluminum extrusion.
- Holds up to 1-7/8" diameter.
- Center point of rotation is 2" (50,8mm) above the base plate.
- Holder will rotate 45° up or down.
- Total of 2.81" (71,37mm) Horizontal Travel.
- Total of 2.125" (53,98mm) Vertical Travel.



TJ-2 Keyed Bracket

Part No. TJ2-KB (Stock No. 3600-2030)

Tweco Robotics offers a bracket for the TJ-2 TRI-JUST fixture (Stock No. 3500-1100) for locating a keyed fixed automation MIG torch in your weld cell. Adding the TJ-2 fixture along with the keyed bracket in your weld cell will minimize the time spent changing out conductor tubes and torch assemblies. The feature ensures that the original position of the conductor tube to work piece is met time after time.

Simply remove the v-block attachment that comes standard on the TJ-2 TRI-JUST fixture and secure the keyed bracket in place. The same screws holding the v-block in place is used to secure the bracket in place.

The bracket has an opening for a 1.625" outside diameter sleeve to be inserted and a 3/16" key slot for a mating key-stock.



Note: The figure above shows the QF Series Fixed Automation MIG torch attached to the TJ-2 Tri-Just and to the left is the keyed bracket.

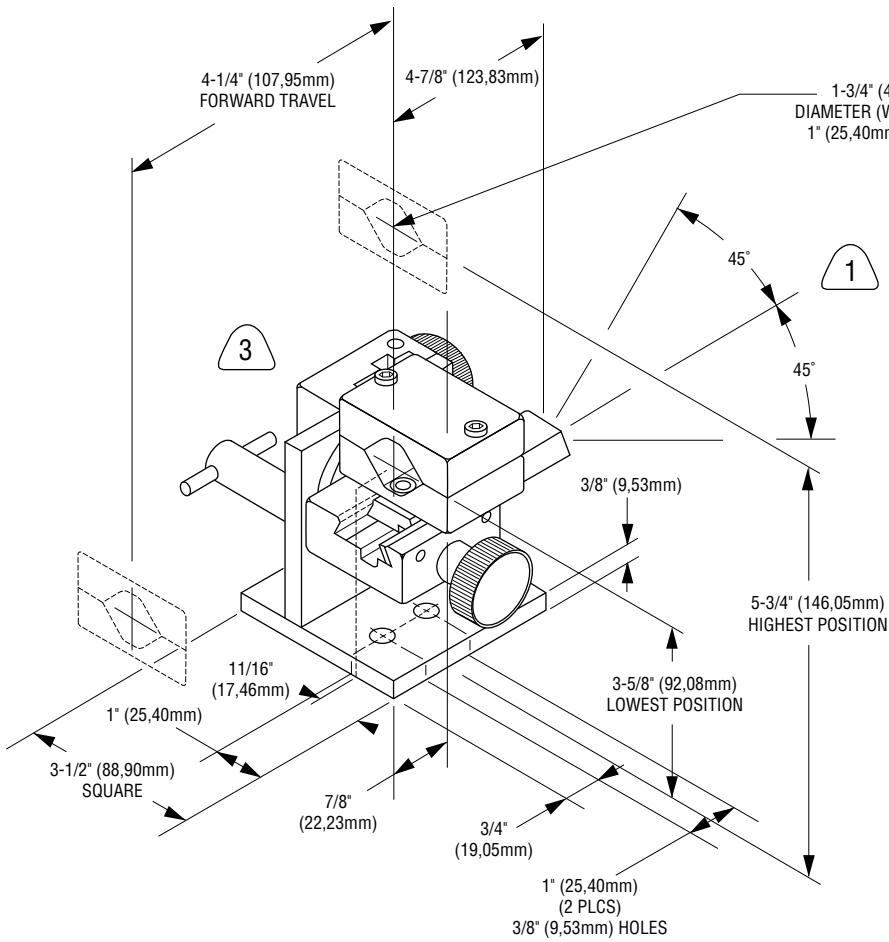

- 2** 1-3/4" (44,45mm) MAXIMUM DIAMETER (WITH OPTIONAL SCREWS)
1" (25,40mm) MINIMUM DIAMETER
- 1** 45°
- 3** CENTER POINT OF ROTATION IS 2" (50,80mm) ABOVE BASE PLATE
- 2** V-BLOCK WILL HOLD STANDARD TWECO MIG-GUN HANDLES USING OPTIONAL SCREWS
- 1** GUN HOLDER ROTATES 45° UP OR DOWN FROM MOUNTING PLATE

TJ-2 Replacement Parts

Vertical Way Block Assembly

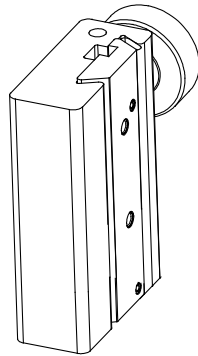

PART NO.	STOCK NO.	DESCRIPTION
TJ-22	3600-2200	VERTICAL WAY BLOCK COMPLETE ASSEMBLY

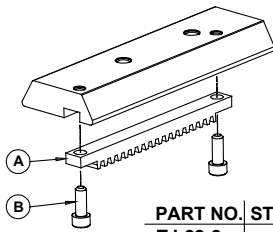

PART NO.	STOCK NO.	DESCRIPTION
TJ-22-2	3600-2220	VERTICAL SLIDE ASSY. - INCLUDES; [A] VERTICAL SLIDE RACK (24 PITCH) [B] 6-32 X 3/8" LG SOCKET HEAD CAP SCREW

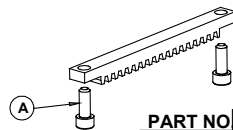

PART NO.	STOCK NO.	DESCRIPTION
TJ-22-2BS	3600-2225	VERTICAL SLIDE RACK (24 PITCH) - INCLUDES 6-32 X 3/8" LG SOCKET HEAD CAP SCREW (2 EACH)

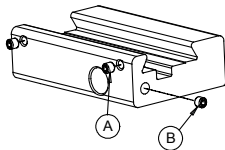

PART NO.	STOCK NO.	DESCRIPTION
TJ-22-1	3600-2210	VERTICAL WAY BLOCK INCLUDES; [A] 10-32 X 1/4" SOCKET HEAD SET SCREW – CONE POINT [B] 10-32 X 3/16" SOCKET HEAD SET SCREW – CUP POINT

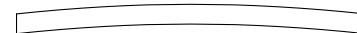

PART NO.	STOCK NO.	DESCRIPTION
TJ-22-2CS	3600-2226	VERTICAL GIB

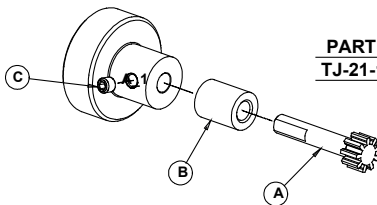

PART NO.	STOCK NO.	DESCRIPTION
TJ-21-1BC	3600-2104	ADJUSTMENT KNOB ASSY. [A] GEAR [B] BUSHING [C] 10-32 X 3/16" LG CUP POINT SET SCREW



PART NO.	STOCK NO.	DESCRIPTION
TJ-21-1CBS	3600-2111	BUSHING

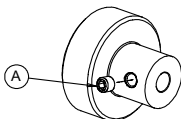

PART NO.	STOCK NO.	DESCRIPTION
TJ-21-1BS	3600-2112	ADJUSTMENT KNOB - INCLUDES 10-32 X 3/16" LG CUP POINT SET SCREW

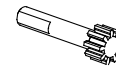

PART NO.	STOCK NO.	DESCRIPTION
TJ-21-1CS	3600-2113	GEAR

TJ-2 Replacement Parts

Horizontal Way Block Assembly

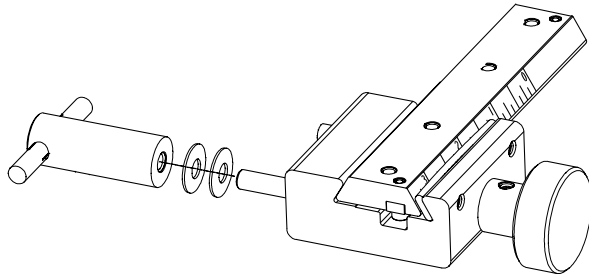

PART NO.	STOCK NO.	DESCRIPTION
TJ-21	3600-2100	HORIZONTAL WAY BLOCK COMPLETE ASSEMBLY

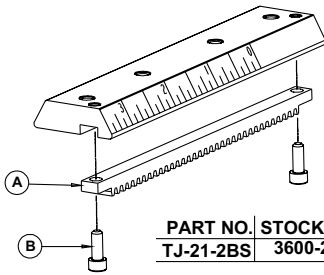

PART NO.	STOCK NO.	DESCRIPTION
TJ-21-2BS	3600-2120	HORIZONTAL SLIDE ASSY. - INCLUDES; [A] HORIZONTAL SLIDE RACK (24 PITCH) [6] -32 X 3/8" LG SOCKET HEAD CAP SCREW

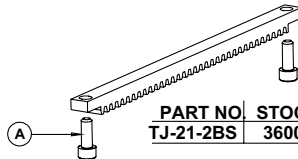

PART NO.	STOCK NO.	DESCRIPTION
TJ-21-2BS	3600-2126	HORIZONTAL SLIDE RACK (24 PITCH) - INCLUDES [A] 6-32 X 3/8" LG SOCKET HEAD CAP SCREW (2 EACH)

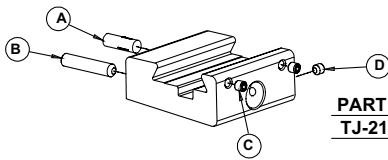

PART NO.	STOCK NO.	DESCRIPTION
TJ-21-1	3600-2101	HORIZONTAL WAY BLOCK INCLUDES; [A] .250 DIA. X .75" LG DOWEL [B] .250-20 X 1.25" LG SOCKET HEAD SET SCREW [C] 10-32 X .250" LG CONE POINT SET SCREW [D] 10-32 X 3/16" LG CUP POINT SET SCREW

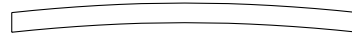

PART NO.	STOCK NO.	DESCRIPTION
TJ-21-2CS	3600-2125	HORIZONTAL GIB

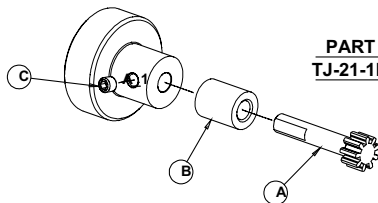

PART NO.	STOCK NO.	DESCRIPTION
TJ-21-1BCS	3600-2104	ADJUSTMENT KNOB ASSY. [A] GEAR [B] BUSHING [C] 10-32 X 3/16" LG CUP POINT SET SCREW

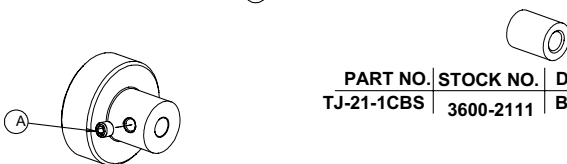

PART NO.	STOCK NO.	DESCRIPTION
TJ-21-1CBS	3600-2111	BUSHING

PART NO.	STOCK NO.	DESCRIPTION
TJ-21-1BS	3600-2112	ADJUSTMENT KNOB - INCLUDES 6-32 X 3/8" LG SOCKET HEAD CAP SCREW (2 EACH)

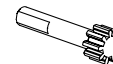

PART NO.	STOCK NO.	DESCRIPTION
TJ-21-1CS	3600-2113	GEAR

TJ-2 Replacement Parts

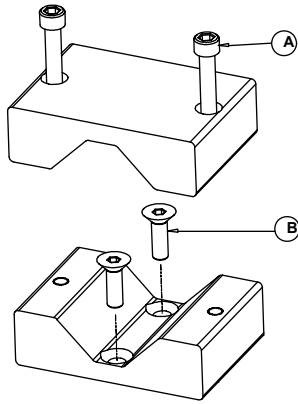

PART NO.	STOCK NO.	DESCRIPTION
TJ-20	3600-2020	MOUNTING BLOCK ASSY. - INCLUDES;
		[A] 10-32 X 1-1/4" LG SHCS (2 EACH)
		[B] 10-32 X 5/8" LG FHCS (2 EACH)
		[NS] 10-32 X 2" LG SHCS (2 EACH)

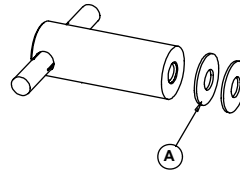

PART NO.	STOCK NO.	DESCRIPTION
TJ-21-3	3600-2130	LOCK KNOB ASSY - INCLUDES
		[A] DISK SPRING KNOB WASHER (2 EACH)

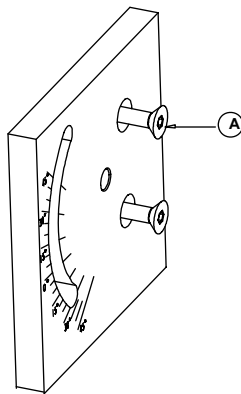

PART NO.	STOCK NO.	DESCRIPTION
TJ-22-4	3600-2241	SLIDE ATTACHMENT PLATE - INCLUDES
		[A] 6-32 X 3/8" LG SOCKET HEAD CAP SCREW (2 EACH)

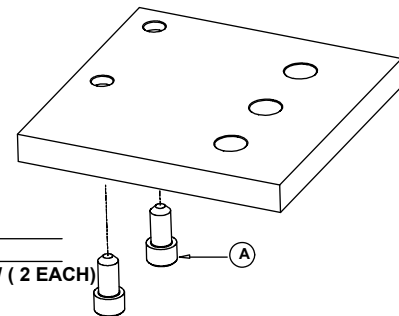

PART NO.	STOCK NO.	DESCRIPTION
TJ-23	3600-2300	BASE PLATE ASSY. - INCLUDES
		[A] 6-32 X 3/8" LG SOCKET HEAD CAP SCREW (2 EACH)

**Reduce spatter build up in your MIG nozzle!
Removal of spatter made easier!
Provide better gas flow and improved weld quality!**

**QRM-100 Anti-Spatter Mist Applicator
(Stock No. 3500-1405)**

Reduce spatter build-up inside the MIG nozzle and see less downtime, better gas flow and improved weld quality. The anti-spatter compound is dispensed from the QRM-100 to the conductor tube and through the diffuser, applying a light film of anti-spatter compound on the nozzle surface to make spatter adherence more difficult.



Tweco® Robotics QRM-100 Anti-Spatter Mist Applicator replaces the “old” style anti-spatter mist applicator Part Number QRM-1. The pump mechanism is totally enclosed in a metal shroud to decrease the chance of foreign material damaging the unit that could result in down production time.

The unit will deliver a metered amount of Protex® anti-spatter compound to the conductor tube assembly on demand at any available time in the weld cycle, during part changes, or during the cleaning cycle. It uses a 24-volt D.C. solenoid valve that can be readily interfaced to a robot controller or other D.C. type power source.

Other features include:

- Frequency adjustments from up to 200 pulses per minute.
- Metering device that delivers a set amount of anti-spatter compound with every pulse.
- Easy to install into a weld cell. Two surfaces to choose from when mounting the unit.
- Each adjustment is clearly identified on the metal enclosure.
- Furnished with 10ft. (3m) of purge hose to run between the unit and torch cable assembly.
- Mounting hardware supplied.
- 1-pint reservoir (optional 1-quart size - sold separately).
- Furnished with a keyed 3-conductor cable with a molded straight female connection to connect from the unit to a robot control panel or equivalent device.

Protex® Select Anti-Spatter

Recommend the use of Tweco Robotics Protex Select Anti-Spatter with the QRM-3 Anti-Spatter Mist Applicator. Protex Select contains no fluorocarbons or chlorinated solvents. The water based Protex Select is non-toxic, nonflammable and environmentally safe.

Container Size	Part No.	Stock No.
1 Gallon/3.8L (Pkg. 4)	RPS1G-4	3044-1900
55 gallon/208L (Drum)	RPS55G	3044-1901

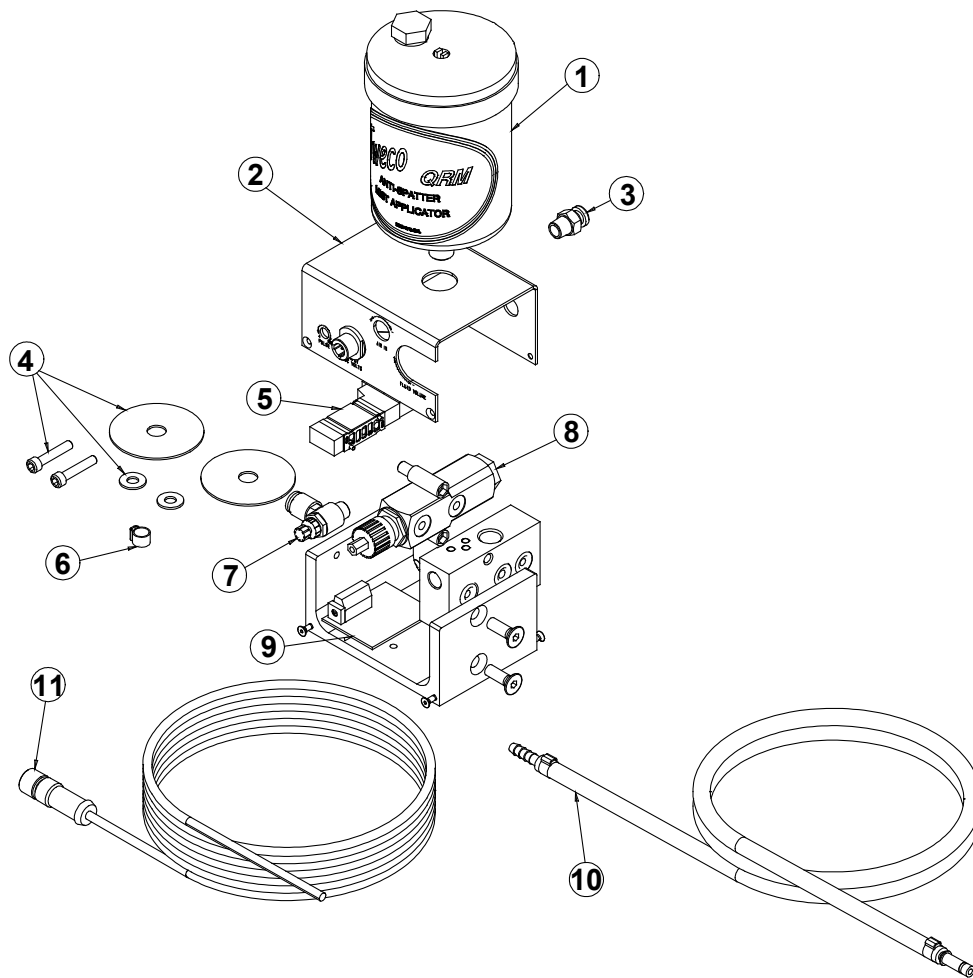

Item No.	Part No.	Stock No.	Description
1	QRC-417	3500-1226	One Pint Reservoir (Standard)
	QRM-R	3500-1338	One Quart Reservoir (Optional)
2	QRM-122	3500-1413	Cover Assembly with Screws (4 each)
3	QRM-3Q	3500-1415	Air Fitting – 1/8" NPT – 1/4" Tube Straight Fitting
4	QRM-100MK	3500-1407	Mounting Hardware
5	QRM-142	3500-1409	Solenoid Valve
6	QRM-109	3500-1414	Hose Clamp (5 each)
7	QRM-101	3500-1410	Air Flow Control
8	QRM-112	3500-1406	Servo Meter with Standoffs & O-rings
9	QRM-141	3500-1412	Circuit Board
10	QRM-108	3500-1408	Purge Hose
11	QRM-143	3500-1411	Control Cable

Enhance your water-cooled MIG welding process by incorporating a water-cooler from Tweco® Products.



Standard Features:

- Vertical or horizontal models available.
- Designed for MIG guns up to 800 amps and TIG torches up to 500 amps.
- Stainless steel construction eliminates coolant contamination due to electrolyte and chemical reactions.
- High efficiency radiator design pulls outside air through radiator.
- Available with either gear or vane pumps.
- Pump by-pass to tank on rotary gear pump – keeps pump from overheating.
- Vane pumps are equipped with a bypass to eliminate excessive pump wear.

Part No.	Stock No.	Description
TC900-G	4010-1010	Cooler w/ Gear Pump – Horizontal – 110V 50/60 Hz.
TC900-V	4010-1011	Cooler w/ Vane Pump – Horizontal – 110V 50/60 Hz.
TC900-GX	4010-1012	Cooler w/ Vane Pump – Horizontal – 230V 50/60 Hz.
TCV900-G	4010-1035	Cooler w/ Gear Pump – Vertical – 110V 50/60 Hz.
TCV900-V	4010-1036	Cooler w/ Vane Pump – Vertical – 110V 50/60 Hz.

Protex® Coolant

Recommend the use of Tweco Protex coolant with the coolers mentioned above.

Container Size	Part No.
1 Gallon/3.8L (Pkg. 4)	57-016-100
55 gallon/208L (Drum)	57-056-100

TC900 Water Cooler Replacement Parts

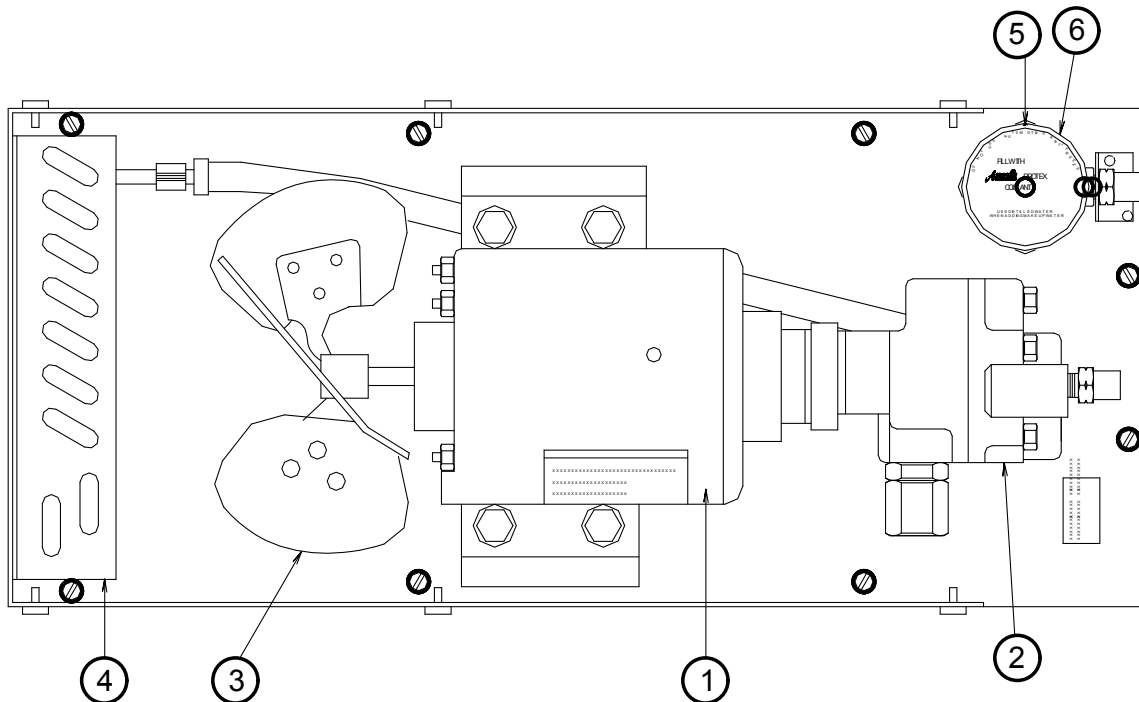

Item No.	Part No.	Stock No.	Description
1	TC9-M	4120-2000	Electric Motor – ¼ HP – 115/230 V – 50/60 Hz
2	TC9-GP	4120-2004	Rotary Gear Pump
	TC9-VP	4120-2005	Rotary Vane Pump
3	TC9-F	4120-2010	Fan
4	TC9-RC	4120-2011	Radiator Coil
5	TC9-SG	4120-2012	Sight Glass Assembly
6	TC9-SGC	4120-2013	Sight Glass Cap
NS	TC9-GPK	4120-2006	Rotary Gear Pump Repair Kit – Includes (2) gears, (2) shafts, carbon Bearing, seals and pump gasket

NOTE: When ordering Part No. TC9-GPK, Rotary Gear Pump Kit, specify stock number and serial number located on the lid under the pump.

**U.S. Customer Care: 800-426-1888 / FAX 800-535-0557 • Canada Customer Care: 905-827-4515 / FAX 800-588-1714
International Customer Care: 905-827-9777 / FAX 905-827-9797 • www.tweco.com**



A Global Cutting & Welding Market Leader™

THE AMERICAS

Denton, TX USA
U.S. Customer Care
Ph: (1) 800-426-1888
Fax: (1) 800-535-0557

Miami, FL USA
Sales Office, Latin America
Ph: (1) 954-727-8371
Fax: (1) 954-727-8376

Oakville, Ontario, Canada
Canada Customer Care
Ph: (1) 905-827-4515
Fax: (1) 800-588-1714
International Customer Care
Ph: (1) 905-827-9777
Fax: (1) 905-827-9797

EUROPE

Chorley, United Kingdom
Customer Care
Ph: (44) 1257-261755
Fax: (44) 1257-224800

Milan, Italy
Customer Care
Ph: (39) 0236546801
Fax: (39) 0236546840

ASIA/PACIFIC

Cikarang, Indonesia
Customer Care
Ph: 62 21+ 8983-0011 / 0012
Fax: 62 21+ 893-6067

Osaka, Japan
Sales Office
Ph: 816-4809-8411
Fax: 816-4809-8412

Melbourne, Australia
Australia Customer Care
Ph: 1300-654-674
Fax: 613+ 9474-7391
International
Ph: 613+ 9474-7508
Fax: 613+ 9474-7488

Rawang, Malaysia
Customer Care
Ph: 603+ 6082-2988
Fax: 603+ 6082-1085

Shanghai, China
Sales Office
Ph: 86 21+ 6280-1273
Fax: 86 21+ 3226-0955

Singapore
Sales Office
Ph: 65+ 6832-8066
Fax: 65+ 6763-5812