



TRAMONTINA

PROGRAM | PROGRAMA

2 0 1 1



TRAMONTINA

Tramontina: 1911-2011

O mundo mudou muito desde que a **Tramontina** fabricou seu primeiro canivete. Mas alguns valores continuam como naquela época: os almoços de família, a alegria de receber os amigos em casa, as comemorações do final de semana, a satisfação de encontrar pessoas especiais. Momentos assim são iguais há muito tempo. E, há pelo menos 100 anos, contam com a companhia da **Tramontina**.

A paixão pela casa, pelo novo, pelo design e pela tecnologia fez com que a **Tramontina** desenvolvesse mais de 17 mil produtos diferentes, tanto para consumidores como para profissionais em diferentes atividades. Mas o que fez a empresa conquistar o Brasil e outros 120 países foram valores cultivados desde o princípio: o respeito ao ser humano, o cuidado com o meio ambiente e a confiança mútua. Esses valores formam a base do relacionamento com colaboradores, fornecedores, clientes e consumidores da **Tramontina**.

Essa amizade, construída ao longo de um século, é o que nos permite entrar na casa das pessoas e compartilhar com elas o que existe de melhor: os bons momentos da vida.

The world has changed a lot since **Tramontina** manufactured its first penknife. But some values have stayed the same: family dinners, the joy of inviting friends over, weekend celebrations, the satisfaction of getting together with loved ones. These moments have stayed the same for a long time and for at least 100 years, they have counted on **Tramontina's** company.

Its passion for the home, for what is new, for design and technology have led **Tramontina** to develop more than 17,000 different products for consumers and professionals in a wide variety of activities. But what has truly led the company to win over Brazil and 120 other countries have been the values it has cultivated from the very beginning: respect for human beings, care for the environment and mutual trust. These values establish the foundation for **Tramontina's** relationship with employees, suppliers, customers and consumers.

This friendship, built over the course of the last century, is what has allowed us to enter people's homes and share the best moments of their lives with them.

El mundo cambió mucho desde que **Tramontina** fabricó su primera navaja. Pero algunos valores continúan como en aquella época: los almuerzos en familia, la alegría de recibir a los amigos en casa, las conmemoraciones de fin de semana, la satisfacción de encontrar a personas especiales. Momentos así son iguales hace mucho tiempo. Y, hace por lo menos 100 años, cuentan con la compañía de **Tramontina**.

La pasión por la casa, por lo nuevo, por el diseño y por la tecnología hizo que **Tramontina** desarrollase más de 17 mil productos diferentes, tanto para consumidores como para profesionales en diferentes actividades. Pero lo que hizo que la empresa conquistara Brasil y otros 120 países fueron valores cultivados desde el principio: el respeto al ser humano, el cuidado del medio ambiente y la confianza mutua. Esos valores forman la base de la relación con colaboradores, proveedores, clientes y consumidores de **Tramontina**.

Esa amistad construida a lo largo de un siglo es lo que nos permite entrar en la casa de las personas y compartir con ellas lo mejor que existe: los buenos momentos de la vida.

TRAMONTINA

MASTER

**Ferramentas profissionais
para construção civil**

Professional tools for contractors

Herramientas profesionales para
construcción civil

ÍNDICE GERAL | INDEX | ÍNDICE

1

Ferramentas de golpe
Striking tools | Herramientas de golpear
12



2

Alicates e torques
Pliers and pincers | Pinzas y tenazas
48



3

Chaves de fenda
Screwdrivers | Destornilladores
64



4

Chaves de aperto
Wrenches and spanners | Llaves de ajuste
80



5

Ferramentas de medição
Measuring tools | Herramientas de medición
100



6

Ferramentas de corte, desbaste e afiação
Cutting, thinning and sharpening tools
Herramientas de corte, desbaste y afilación
108



7

Pistola aplicadora de silicone e grampos
Silicone caulking gun and clips
Pistola aplicadora de silicona y grampadoras
124

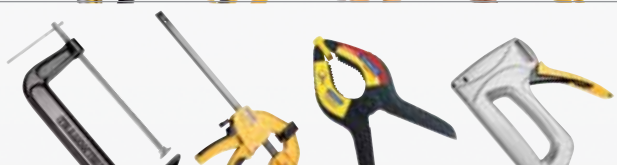

8

Ferramentas elétricas e lanternas
Electrical tools and flashlights
Herramientas electricas y linternas
128



9

Jogos e organizadores de ferramentas
Sets and tool storage
Juegos y organizadores de herramientas
134



10

Materiais de Consumo
Consumables | Consumibles
166



Expositores | Estrutura Comercial
Displays and Sales conditions
Exhibidores y Condiciones de ventas
177





► Divisão de ferramentas manuais | Hand tools division | División de herramientas manuales

TRAMONTINA GARIBALDI

Fundada em 1963, a Tramontina Garibaldi S.A. [Garibaldi, RS] conta com 62 mil m² de área construída e 500 funcionários. Oferece aos mercados interno e externo duas modernas linhas de produtos: Tramontina PRO, especializada em ferramentas profissionais para os segmentos de manutenção industrial e automotiva. São carrinhos e caixas para ferramentas, soquetes, torquímetros, chaves de aperto, ferramentas isoladas 1000V, antifaiscantes, alicates, chaves de fenda, entre outros. E Tramontina Master, especializada em ferramentas profissionais para a construção civil, como martelos, marretas, níveis, talhadeiras, serrotes, formões e ferramentas diversas.

Established in 1963, Tramontina Garibaldi S.A. [located at Garibaldi city, RS] has a built area of 51.000 m² and 500 employees. It offers to both domestic and abroad markets two modern lines of products: Tramontina Pro specializes in professional hand tools to meet the industrial and automotive demands. The line is composed of tools cabinets and boxes, sockets, torque wrenches, wrenches, spanners, 1.000V insulated tools, non-sparking tools, pliers, screwdrivers, among others. Tramontina Master, specializes in professional hand tools for contractors such as hammers, sledge hammers, levels, stone chisels, saws, wood chisels and sundry tools.

Fundada en 1963, Tramontina Garibaldi S.A. [Garibaldi, RS] cuenta con 51 mil m² de área construída y 500 empleados. Ofrece a los mercados interno y externo dos modernas líneas de productos: Tramontina PRO, especializada en los segmentos de mantenimiento industrial y automotriz, con variados artículos, como carros y cajas porta herramientas, dados, torquímetros, llaves de ajuste, llaves aisladas 1.000V, antichispas, pinzas, destornilladores, entre otras, y Tramontina Master, especializada en herramientas profesionales para la construcción civil, como martillos, mazas, niveles, cinceles, serruchos, formones y herramientas diversas.



► Divisão de cabos e insumos de madeira | Hardwood handles and wooden inputs division | *División de mangos e insumos de madera*



Distâncias | Distances | *Distâncias* (Km)

Rio de Janeiro-São Paulo: 450
São Paulo-Porto Alegre: 1.100
Porto Alegre-Garibaldi: 115

A Tramontina produz, em suas dez fábricas, 17 mil itens para os mais diversos segmentos. São panelas, baixelas, talheres, facas, utensílios domésticos em aço inox, *cooktops*, coifas, pias e cubas, materiais elétricos para instalação doméstica e industrial, mesas e cadeiras em madeira e plástico, além de ferramentas para agricultura, construção civil, jardinagem e ferramentas manuais de alta especialização. E, para fazer uma boa distribuição do volume de produtos, investe em tecnologia de produção, logística e marketing, que possibilitam levar a marca da empresa para mais de 120 países.

Tramontina manufactures, in 10 factories, more than 17 thousand products for several different areas. These are pans, tableware set, cutlery, knives, stainless steel household goods, sinks, bowls, cooking hobs, ceramic glass surfaces, electrical materials for domestic and industrial installations, plastic and wooden furniture. Tramontina's range also includes agricultural, gardening and construction tools as well as hand tools, all made to a high technical specification. Also to improve distribution of all the products, it invests in production technology, highly sophisticated logistical operations and marketing, that makes it possible to create a strong presence in more than 120 countries.

Tramontina fabrica, em sus diez plantas, 17 mil artículos para los más diversos segmentos. Ollas, juegos de fuentes, cubiertos, cuchillos, utensílios domésticos de acero inoxidable, fregaderos y cubetas, *cooktops*, *vitro grills*, materiales eléctricos para instalaciones domésticas e industriales, mesas y sillas de madera y plástico, además de herramientas para agricultura, construcción civil, jardinería y herramientas manuales de alta especialización. Para hacer una buena distribución del volumen de productos, invierte en tecnología de producción, logística y mercadeo, actividades que posibilitan llevar la marca de la empresa a más de 120 países.



A Tramontina proporciona um clima organizacional harmônico. O capital humano é a sua base. Por isso, aposta no crescimento profissional e pessoal de sua equipe, que totaliza 6 mil colaboradores.

Mas uma empresa só poderia fazer tudo isso, com o apoio de parceiros. Por esse motivo, tem como objetivo principal colocar os clientes e consumidores como foco. A Tramontina sempre teve qualidade e foi reconhecida. Sempre respeitou e foi respeitada. Sempre confiou e ganhou confiança. Esse é o tipo de relacionamento que a Tramontina acredita.

Tramontina provides a harmonious environment throughout the organization. The people are considered the base and, for this reason, the company invests continuously in the professional and personal growth of its team of more than 6 thousand people.

All of this is only possible with the collaboration of good partners. Therefore, Tramontina's customers always come first. The company has always invested in quality which is internationally recognized. Tramontina respects and is respected, trusts and is trusted. This is the kind of a relationship that Tramontina believes in.

Tramontina proporciona un clima organizacional armónico. El capital humano es su base. Por eso, apuesta al crecimiento profesional y personal de su equipo, integrado por 6 mil colaboradores.

Pero una empresa puede hacer todo eso únicamente con el apoyo de colegas. Por este motivo, tiene como objetivo principal a sus clientes y consumidores. Tramontina siempre tuvo calidad y fue reconocida. Siempre respetó y fue respetada. Siempre confió y ganó confianza. Ese es el tipo de relacionamiento en el que Tramontina cree.



Valoriza a consciência social e o respeito ao meio ambiente, pois acredita que cuidar do planeta é uma maneira de garantir uma qualidade de vida melhor para todos.

It values a social conscience and respect for the environment as it believes that taking care for the planet is a way to guarantee a better quality of life for all.

Tramontina valora la conciencia social y el respeto por el medio ambiente, pues cree que cuidar del planeta es una manera de garantizar una calidad de vida mejor para todos.

FABRICAÇÃO | MANUFACTURING | FABRICACIÓN

Investir continuamente na atualização tecnológica dos meios de produção, na expansão das áreas industriais e no conhecimento é prioridade na Tramontina. Tudo é feito para assegurar a constante melhora dos processos e atender à dinâmica de um mercado sempre em transformação. É dessa forma, buscando renovação permanente, que a empresa garante sua credibilidade nos mercados nacional e internacional.

Steadfastly investing in technology and updating of production methods means an opening up the industrial areas and making knowledge it's priority is paramount at Tramontina. Everything is done to assure steadfast improvement in procedures and to serve the needs of an dynamic and ever changing market.

Invertir continuamente en la actualización tecnológica de los medios de producción, en la expansión de áreas industriales y en el conocimiento, es prioridad en Tramontina. Todo está pensado para asegurar la constante mejora de los procesos y atender la dinámica de un mercado siempre en transformación.

Some of the products are outsourced through manufacturing agreements and there are strict standards, controls, specifications and Tramontina's guarantee. These items are marked with a * symbol in this catalogue. It is this criteria and by constantly updating its technology that the company guarantees its credibility in both domestic and international markets.

Algunos productos son tercerizados a través de acuerdos de producción que siguen estrictos padrones, controles, especificaciones y garantía de Tramontina. Estos artículos están señalizados con una * en este programa. De esa manera, buscando la renovación permanente, la empresa garantiza su credibilidad en los mercados nacionales e internacionales.



► 12 linhas de forja
12 forging lines
12 líneas de forja



► Tratamento térmico
Heat Treatment
Tratamiento térmico



QUALIDADE | QUALITY | CALIDAD

Aliando tecnologia e experiência, a Tramontina tem a segurança de oferecer ao mercado profissional o melhor em ferramentas manuais, pois a qualidade é o princípio que abrange todas as ações da organização. Desde 1994, a Tramontina mantém a certificação ISO 9001/2000 no segmento ferramentas, sendo pioneira no Brasil.

Connecting technology and experience, Tramontina is confident in offering the professional market the best in hand tools, as quality is the starting-point that embraces all other actions of the organization. Tramontina was a pioneer in Brazil in the hand tools area and obtained the ISO 9001/2000 certification which it has had since 1994.

Aliando tecnología y experiencia, Tramontina tiene la seguridad de ofrecer al mercado profesional lo mejor en herramientas manuales, pues calidad es el principio que abarca todas las acciones de la organización. Tramontina ha sido la pionera en Brasil, en el segmento de herramientas manuales, en la obtención del certificado ISO 9001/2000, en el año de 1994.



CIPeD

O CIPeD [Centro de Inovação, Pesquisa e Desenvolvimento da Tramontina] é constituído por modernos laboratórios que reúnem equipamentos de última geração, para propiciar o desenvolvimento de ferramentas manuais para uso profissional, que atendem as mais rigorosas normas de fabricação.

O CIPeD é composto de:

- Laboratório Metalográfico
- Laboratório de Análises Físico-químicas
- Laboratório de Ferramentas Isoladas
- Laboratório de Torque
- Laboratório de Ensaios Mecânicos
- Laboratório de Ensaios com Geração de Ruídos



The CIPeD [Tramontina Centre of Innovation, Research and Development] is composed of modern laboratories that bring together the latest generation of equipment to facilitate the development of professional hand tools, which meet the highest manufacturing standards.

The CIPeD consists of:

- Metallographic laboratory
- Physical-Chemical analysis laboratory
- Insulated tools laboratory
- Torque laboratory
- Mechanical tests laboratory
- Noise generation tests laboratory

El CIPeD (Centro de Innovación, encuesta y desarrollo de productos) es constituído por modernos laboratorios que cuentan con equipamientos de última modernidad, para propiciar el desarrollo de herramientas manuales para uso profesional, que atienden las más rígidas normas de fabricación.

El CIPeD es compuesto de:

- Laboratorio de Metalografía
- Laboratorio de Análisis Físicoquímicas
- Laboratorio de Herramientas Aisladas
- Laboratorio de Torque
- Laboratorios de Ensayos Mecánicos
- Laboratorios de Ensayos con generación de ruidos



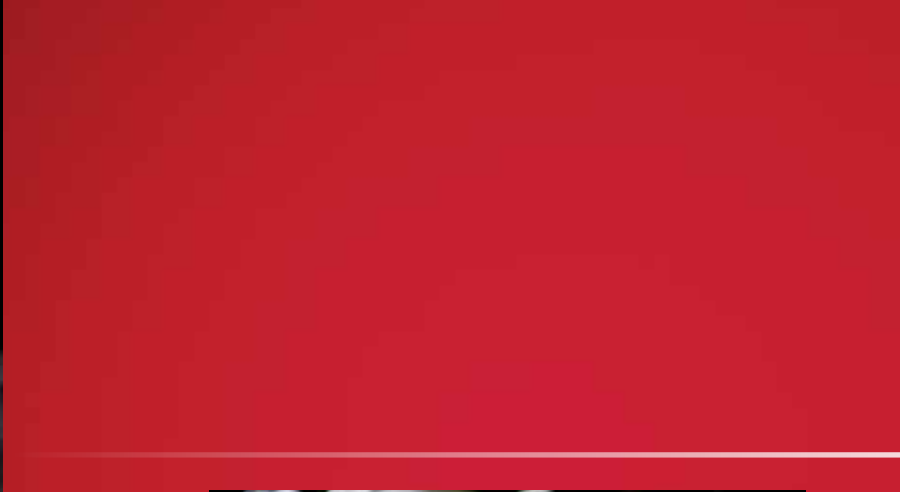

1

FERRAMENTAS DE GOLPE
STRIKING TOOLS
HERRAMIENTAS DE GOLPEAR





40300 Martelo de Unha
Claw Hammer
Martillo de Uña

REF.	Tamanho Size <i>Tamaño</i>	EAN 789.1114	Embalagem Package <i>Embalaje</i>		Dimensões Dimensions (mm)				
			Un.	KG	Comp x larg x alt Length x width x height <i>Largo x ancho x altura</i>	A	B	C	D
40300/027	27mm	00070 2	12	9,54	380 x 220 x 135mm	120	335	27	33
40300/029	29mm	00071 9	12	11,50	400 x 245 x 150mm	127	352	29	38

Cabeça forjada e temperada em aço carbono especial.
Acabamento jateado e cabeça envernizada.
Cabo em madeira envernizada fixado com epóxi.

IPI 8% incluso - NCM: 8205.20.00

Forged and hardened carbon steel head.
Sand blasted and varnished head.
Hardwood handle fixed with epoxy.

*Cabeza forjada en acero carbono y templada.
Acabado jateado y cabeza barnizada.
Mango de madera fijado con epoxi.*

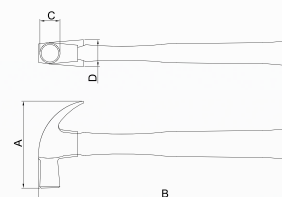

40370 Martelo de Unha - Basic
Claw Hammer - Basic
Martillo de Uña - Basic

REF.	Tamanho Size <i>Tamaño</i>	EAN 789.1114	Embalagem Package <i>Embalaje</i>		Dimensões Dimensions (mm)				
			Un.	KG	Comp x larg x alt Length x width x height <i>Largo x ancho x altura</i>	A	B	C	D
40370/018	18mm	09106 9	12	2,95	280 x 170 x 95mm	83	250	18	24
40370/020	20mm	01616 1	12	4,40	320 x 190 x 100mm	92	278	20	27,5
40370/023	23mm	01617 8	12	6,34	335 x 210 x 115mm	102,5	300	23	28
40370/025	25mm	01618 5	12	7,76	360 x 210 x 130mm	112	323	25	30
40370/027	27mm	01619 2	12	7,92	360 x 210 x 130mm	120	335	27	33
40370/029	29mm	08147 3	12	9,65	400 x 245 x 140mm	125	350	29	37

Cabeça forjada e temperada em aço carbono especial.
Acabamento jateado e cabeça envernizada.
Cabo em madeira envernizada fixado com epóxi.

IPI 8% incluso - NCM: 8205.20.00

Forged and hardened carbon steel head.
Sand blasted and varnished head.
Hardwood handle fixed with epoxy.

*Cabeza forjada en acero carbono y templada.
Acabado jateado y cabeza barnizada.
Mango de madera fijado con epoxi.*

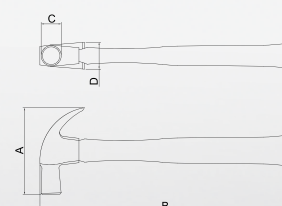

40200 Martelo de Unha Claw Hammer Martillo de Uña

REF.	Tamanho Size Tamaño	EAN 789.1114	Embalagem Package Embalaje			Dimensões Dimensions (mm)			
			Un.	KG	Comp x larg x alt Length x width x height Largo x ancho x altura	A	B	C	D
40200/018	18mm	00384 0	12	2,95	280 x 170 x 95mm	83	250	19	24
40200/020	20mm	00062 7	12	4,06	320 x 190 x 100mm	92	278	21,5	26
40200/023	23mm	00063 4	12	5,91	335 x 210 x 115mm	102,5	300	23	30
40200/025	25mm	00064 1	12	7,28	360 x 210 x 130mm	112	323	25	33
40200/027	27mm	00065 8	12	8,84	380 x 220 x 135mm	120	335	27	35
40200/029	29mm	00066 5	12	10,64	400 x 245 x 140mm	127	352	29	37

Cabeça forjada e temperada em aço carbono especial.
Acabamento polido e envernizado.
Cabo em madeira envernizada fixado com epóxi.

IPI 8% incluso - NCM: 8205.20.00

Forged and hardened carbon steel head.
Polished and varnished head.
Hardwood handle fixed with epoxy.

*Cabeza forjada en acero carbono y templada.
Cabeza pulida y barnizada.
Mango de madera fijado con epoxi.*

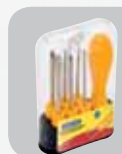
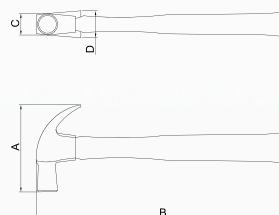

40700 Martelo de Unha - Extra Fortis Claw Hammer - Extra Fortis Martillo de Uña - Extra Fortis

REF.	Tamanho Size Tamaño	EAN 789.1114	Embalagem Package Embalaje			Dimensões Dimensions (mm)			
			Un.	KG	Comp x larg x alt Length x width x height Largo x ancho x altura	A	B	C	D
40700/027	27mm	00100 6	6	4,71	380 x 100 x 150mm	120	325	27	34

Cabeça forjada e temperada em aço carbono especial.
Acabamento polido e envernizado.
Cabo de fibra de vidro fixado com epóxi e pino elástico.
Empunhadura injetada.

IPI 8% incluso - NCM: 8205.20.00

Forged and hardened carbon steel head.
Polished and varnished head.
Fiberglass handle fixed with epoxy and elastic safety pin.
Injected PVC grip.

*Cabeza forjada en acero carbono y templada.
Cabeza pulida y barnizada.
Mango de fibra de vidrio fijado con epoxi y perno elástico de seguridad.
Empuñadura de PVC inyectado.*

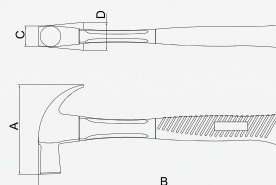



40800 Martelo de Unha - Tubo Fort
Claw Hammer
Martillo de Uña

REF.	Tamanho Size <i>Tamaño</i>	EAN 789.1114	Embalagem Package <i>Embalaje</i>			Dimensões Dimensions (mm)			
			Un.	KG	Comp x larg x alt Length x width x height <i>Largo x ancho x altura</i>	A	B	C	D
40800/027	27mm	02999 4	6	4,85	380 x 100 x 150mm	120	320	27	35

Cabeça forjada e temperada em aço carbono especial.
Acabamento polido e envernizado.
Cabo de aço temperado fixado com epóxi e pino elástico.
Empunhadura injetada.

IPI 8% incluso - NCM: 8205.20.00

Forged and hardened carbon steel head.
Polished and varnished head.
Carbon steel tubular handle fixed with epoxy and elastic safety pin.
Injected PVC grip.

Cabeza forjada en acero carbono y templada.
Cabeza pulida y barnizada
Mango tubular de acero carbono fijado con epoxi y perno elástico de seguridad.
Empuñadura de PVC inyectado.

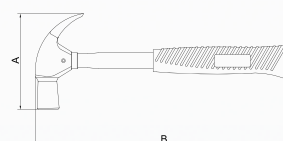
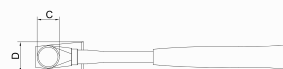

40890 Martelo de Unha - Cabo tubular longo
Claw Hammer
Martillo de Uña

REF.	Tamanho Size <i>Tamaño</i>	EAN 789.1114	Embalagem Package <i>Embalaje</i>			Dimensões Dimensions (mm)			
			Un.	KG	Comp x larg x alt Length x width x height <i>Largo x ancho x altura</i>	A	B	C	D
40890/027	27mm	04399 0	12	10,42	535 x 210 x 130mm	116	468	27	33

Cabeça forjada e temperada em aço carbono especial.
Acabamento jateado e cabeça envernizada.
Cabo fixado através de dobra e conformação do próprio tubo.
Comprimento do cabo: 42cm.

IPI 8% incluso - NCM: 8205.20.00

Forged and hardened carbon steel head.
Sand blasted and varnished head.
Carbon steel tubular handle.
Handle length: 42cm

Cabeza forjada en acero carbono y templada.
Acabado jateado y cabeza barnizada.
Mango tubular de acero carbono.
Extensión del mango: 42cm

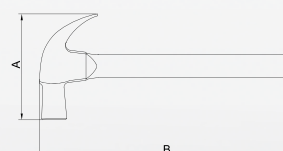
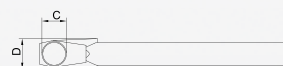

40301 Martelo de Unha
Claw Hammer
Martillo de Uña Curva

REF.	Tamanho Size <i>Tamaño</i>	EAN 789.1114	Embalagem Package <i>Embalaje</i>			Dimensões Dimensions (mm)			
			Un.	KG	Comp x larg x alt Length x width x height <i>Largo x ancho x altura</i>	A	B	C	D
40301/025 •	25mm	00442 7	12	7,60	380 x 220 x 135mm	120	325	25	32
40301/027 •	27mm	00134 1	12	9,50	395 x 247 x 150mm	130	335	27	36

Cabeça forjada e temperada em aço carbono especial.
Acabamento com pintura eletrostática na cor preta.
Cabo em madeira envernizada fixado com epóxi.

IPI 8% incluso - NCM: 8205.20.00

Forged and hardened carbon steel head.
Black electrostatic painting.
Hardwood handle fixed with epoxy.

*Cabeza forjada en acero carbono y templada.
Pintura electrostática negra.
Mango de madera fijado con epoxi.*

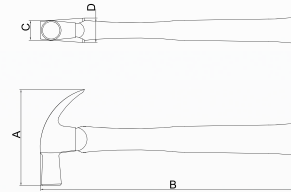

**Produto para
exportação**

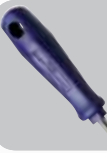

40201 Martelo de Unha
Claw Hammer
Martillo de Uña Curva

REF.	Tamanho Size <i>Tamaño</i>	EAN 789.1114	Embalagem Package <i>Embalaje</i>			Dimensões Dimensions (mm)			
			Un.	KG	Comp x larg x alt Length x width x height <i>Largo x ancho x altura</i>	A	B	C	D
40201/025 •	25mm	00401 4	12	7,00	380 x 235 x 135mm	125	325	25	33
40201/027 •	27mm	00402 1	12	8,70	395 x 247 x 150mm	130	340	27	35

Cabeça forjada e temperada em aço carbono especial.
Acabamento polido e envernizado.
Cabo em madeira envernizada fixado com epóxi.

IPI 8% incluso - NCM: 8205.20.00

Forged and hardened carbon steel head.
Polished and varnished head.
Hardwood handle fixed with epoxy.

*Cabeza forjada en acero carbono y templada.
Cabeza pulida y barnizada.
Mango de madera fijo con epoxi.*

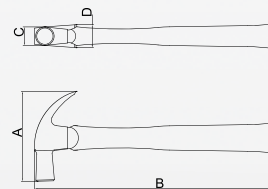

**Produto para
exportação**

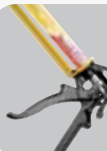



40303 Martelo de Unha
Claw Hammer
Martillo de Uña

REF.	Peso Weight	EAN 789.1114	Embalagem Package Embalaje			Dimensões Dimensions (mm)			
			Un.	KG	Comp x larg x alt Length x width x height Largo x ancho x altura	A	B	C	D
40303/008 •	8oz	03930 6	12	5,13	335 x 210 x 115mm	102,8	293	21,5	26,5
40303/013 •	13oz	03931 3	12	7,68	360 x 210 x 130mm	118,8	318	24,5	31
40303/016	16oz	00406 9	12	8,66	380 x 220 x 135mm	132	330	26	33
40303/020 •	20oz	03932 0	12	9,81	400 x 245 x 140mm	137	330	30	35

Pescoço octogonal.
Cabeça forjada e temperada em aço carbono especial.
Acabamento com pintura eletrostática na cor preta.
Cabo em madeira envernizada fixado com epóxi.

IPI 8% incluso - NCM: 8205.20.00

Octogonal neck
Forged and hardened carbon steel head.
Black electrostatic painting.
Hardwood handle fixed with epoxy.

*Cuello octogonal.
Cabeza forjada en acero carbono y templada.
Pintura electrostática negra.
Mango de madera fijado con epoxi.*

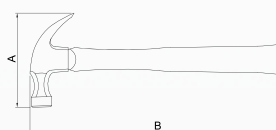

**Produto para
exportação**



40203 Martelo de Unha
Claw Hammer
Martillo de Uña

REF.	Peso Weight	EAN 789.1114	Embalagem Package Embalaje			Dimensões Dimensions (mm)			
			Un.	KG	Comp x larg x alt Length x width x height Largo x ancho x altura	A	B	C	D
40203/008 •	8oz	03927 6	12	4,74	335 x 210 x 115mm	102,8	293	21,5	26,5
40203/013 •	13oz	02660 3	12	7,08	360 x 210 x 130mm	118,8	318	24,5	31
40203/016	16oz	00407 6	12	7,95	380 x 220 x 135mm	132	330	26	33
40203/020 •	20oz	03928 3	12	9,16	400 x 245 x 140mm	137	330	30	35

Pescoço octogonal.
Cabeça forjada e temperada em aço carbono especial.
Acabamento polido e envernizado.
Cabo em madeira envernizada fixado com epóxi.

IPI 8% incluso - NCM: 8205.20.00

Octogonal neck.
Forged and hardened carbon steel head.
Polished and varnished head.
Hardwood handle fixed with epoxy.

*Cuello octogonal.
Cabeza forjada en acero carbono y templada.
Cabeza pulida y barnizada.
Mango de madera fijado con epoxi.*

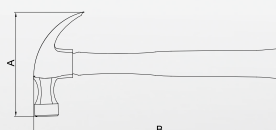

**Produto para
exportação**

40705 Martelo de Unha
Claw Hammer
Martillo de Uña

REF.	Peso Weight	EAN 789.1114	Embalagem Package Embalaje		Dimensões Dimensions (mm)				
			Un.	KG	Comp x larg x alt Length x width x height Largo x ancho x altura	A	B	C	D
40705/016	16oz	00460 1	6	4,26	380 x 100 x 150mm	132	325	28	33
40705/020 •	20oz	04278 8	6	4,87	370 x 195 x 100mm	132	325	30	35

Pescoço octogonal.
Cabeça forjada e temperada em aço carbono especial.
Acabamento polido e envernizado.
Cabo de fibra de vidro fixado com epóxi e pino elástico.
Empunhadura injetada.

IPI 8% incluso - NCM: 8205.20.00

Octogonal neck.
Forged and hardened carbon steel head.
Polished and varnished head.
Fiberglass handle fixed with epoxy and elastic safety pin.
Injected PVC grip.

Cuello octogonal.
Cabeza forjada en acero carbono y templada.
Cabeza pulida y barnizada.
Mango de fibra de vidrio fijado con epoxi y perno elástico de seguridad.
Empuñadura de PVC inyectado.

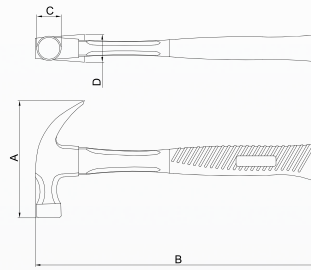

Produto para exportação



40804 Martelo de Unha
Claw Hammer
Martillo de Uña

REF.	Peso Weight	EAN 789.1114	Embalagem Package Embalaje		Dimensões Dimensions (mm)				
			Un.	KG	Comp x larg x alt Length x width x height Largo x ancho x altura	A	B	C	D
40804/016	16oz	02724 2	6	4,60	380 x 100 x 150mm	136	320	28	36

Pescoço octogonal.
Cabeça forjada e temperada em aço carbono especial.
Acabamento polido e envernizado.
Cabo de aço temperado fixado com epóxi e pino elástico.
Empunhadura de PVC.

IPI 8% incluso - NCM: 8205.20.00

Octogonal neck.
Forged and hardened carbon steel head.
Polished and varnished head.
Carbon steel tubular handle fixed with elastic safety pin.
Injected PVC grip.

Cuello octogonal.
Cabeza forjada en acero carbono y templada.
Cabeza pulida y barnizada.
Mango tubular de acero carbono fijado con perno elástico de seguridad.
Empuñadura de PVC inyectado.

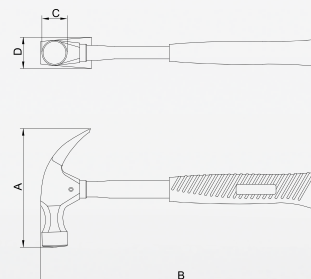

Produto para exportação

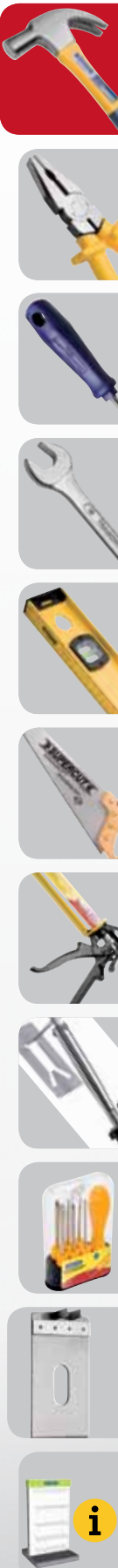



40891 Martelo de Unha
Claw Hammer
Martillo de Uña

REF.	Peso Weight	EAN 789.1114	Embalagem Package Embalaje			Dimensões Dimensions (mm)			
			Un.	KG	Comp x larg x alt Length x width x height Largo x ancho x altura	A	B	C	D
40891/016 •	16oz	04474 4	12	9,04	380 x 220 x 135mm	129	337	27,5	33
40891/020 •	20oz	04475 1	12	10,06	400 x 245 x 140mm	138	337	29	35

Pescoço octogonal.
Cabeça forjada e temperada em aço carbono especial.
Acabamento jateado e cabeça envernizada.
Cabo de aço temperado.
Comprimento do cabo: 28,5cm.

IPI 8% incluso - NCM: 8205.20.00

Octogonal neck.
Forged and hardened carbon steel head.
Sand blasted and varnished head.
Carbon steel tubular handle.
Handle length: 28,5cm.

*Cuello octogonal.
Cabeza forjada en acero carbono y templada.
Acabado jateado y cabeza barnizada.
Mango tubular de acero carbono.
Extensión del mango: 28,5cm.*

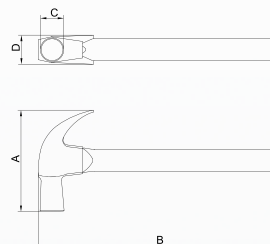

**Produto para
exportação**



40304 Martelo de Unha
Claw Hammer
Martillo de Uña Recta

REF.	Peso Weight	EAN 789.1114	Embalagem Package Embalaje			Dimensões Dimensions (mm)			
			Un.	KG	Comp x larg x alt Length x width x height Largo x ancho x altura	A	B	C	D
40304/016	16oz	00409 0	12	8,86	400 x 245 x 140mm	135	333	38,5	34
40304/020 •	20oz	04083 8	12	10,00	395 x 247 x 150mm	142	335	30	36,5

Pescoço octogonal.
Cabeça forjada e temperada em aço carbono especial.
Acabamento com pintura eletrostática na cor preta.
Cabo em madeira envernizada fixado com epóxi.

IPI 8% incluso - NCM: 8205.20.00

Octogonal neck.
Forged and hardened carbon steel head.
Black electrostatic painting.
Hardwood handle fixed with epoxy.

*Cuello octogonal.
Cabeza forjada en acero carbono y templada.
Pintura electrostática negra.
Mango de madera fijado con epoxi.*

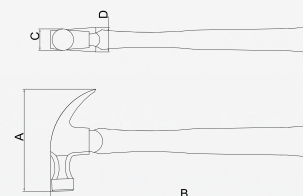

**Produto para
exportação**

40205 Martelo de Unha
Rip Hammer
Martillo de Uña Recta

REF.	Peso Weight	EAN 789.1114	Embalagem Package Embalaje			Dimensões Dimensions (mm)			
			Un.	KG	Comp x larg x alt Length x width x height Largo x ancho x altura	A	B	C	D
40205/016	16oz	00410 6	12	8,38	400 x 245 x 140mm	135	333	31	37
40205/020 •	20oz	03929 0	12	9,50	395 x 247 x 150mm	145	333	31	37

Pescoço octogonal.
Cabeça forjada e temperada em aço carbono especial.
Acabamento polido e envernizado.
Cabo em madeira envernizada fixado com epóxi.

IPI 8% incluso - NCM: 8205.20.00

Octogonal neck.
Forged and hardened carbon steel head.
Polished and varnished head.
Hardwood handle fixed with epoxy.

Cuello octogonal.
Cabeza forjada en acero carbono y templada.
Cabeza pulida y barnizada.
Mango de madera fijado con epoxi.

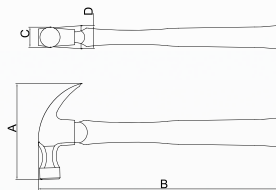

Produto para exportação



40703 Martelo de Unha
Rip Hammer
Martillo de Uña Recta

REF.	Peso Weight	EAN 789.1114	Embalagem Package Embalaje			Dimensões Dimensions (mm)			
			Un.	KG	Comp x larg x alt Length x width x height Largo x ancho x altura	A	B	C	D
40703/016	16oz	04279 5	6	4,90	343 x 175 x 92mm	135	318	28	31
40703/020 •	20oz	04280 1	6	5,03	370 x 195 x 100mm	140	323	29,5	34

Pescoço octogonal.
Cabeça forjada e temperada em aço carbono especial.
Acabamento polido e envernizado.
Cabo de fibra de vidro fixado com epóxi e pino elástico.
Empunhadura de PVC.

IPI 8% incluso - NCM: 8205.20.00

Octogonal neck.
Forged and hardened carbon steel head.
Polished and varnished head.
Fiberglass handle fixed with epoxy and elastic safety pin.
Injected PVC grip.

Cuello octogonal.
Cabeza forjada en acero carbono y templada.
Cabeza pulida y barnizada.
Mango de fibra de vidrio fijado con perno elástico de seguridad.
Empuñadura de PVC inyectado.

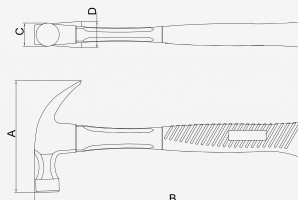

Produto para exportação

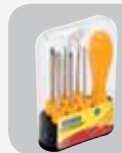



40206 Martelo de Unha
Framing Hammer
Martillo de Uña Recta

REF.	Peso Weight	EAN 789.1114	Embalagem Package Embalaje			Dimensões Dimensions (mm)			
			Un.	KG	Comp x larg x alt Length x width x height Largo x ancho x altura	A	B	C	D
40206/016 •	16oz	04673 1	6	4,30	380 x 160 x 123mm	140	320	29	30
40206/020 •	20oz	02953 6	6	5,68	480 x 160 x 120mm	150	400	31,5	34
40206/022 •	22oz	00411 3	6	6,07	400 x 215 x 120mm	155	400	33	36,5

Pescoço octogonal.
Cabeça forjada e temperada em aço carbono especial.
Acabamento polido e envernizado.
Cabo em madeira envernizada fixado com cunha.

IPI 8% incluso - NCM: 8205.20.00

Octogonal neck.
Forged and hardened carbon steel head.
Polished and varnished head.
Hardwood handle fixed with steel wedge.

Cuello octogonal.
Cabeza forjada en acero carbono y templada.
Cabeza pulida y barnizada.
Mango de madera fijado con cuña metálica.

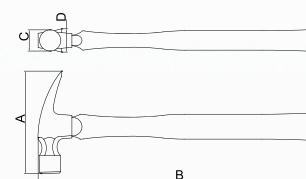

**Produto para
exportação**



40207 Martelo de Unha
Framing Hammer
Martillo de Uña Recta

REF.	Peso Weight	EAN 789.1114	Embalagem Package Embalaje			Dimensões Dimensions (mm)			
			Un.	KG	Comp x larg x alt Length x width x height Largo x ancho x altura	A	B	C	D
40207/016 •	16oz	04674 8	6	4,10	380 x 160 x 120mm	140	320	29	30
40207/020 •	20oz	02954 3	6	5,44	480 x 160 x 120mm	150	400	31,5	33
40207/022 •	22oz	00413 7	6	5,76	400 x 215 x 120mm	155	400	33	35

Pescoço octogonal e base dentilhada.
Cabeça forjada e temperada em aço carbono especial.
Acabamento polido e envernizado.
Cabo em madeira envernizada fixado com cunha.

IPI 8% incluso - NCM: 8205.20.00

Octogonal neck milled face.
Forged and hardened carbon steel head.
Polished and varnished head.
Hardwood handle fixed with steel wedge.

Cuello octogonal base dentillada.
Cabeza forjada en acero carbono y templada.
Cabeza pulida y barnizada.
Mango de madera fijado con cuña metálica.

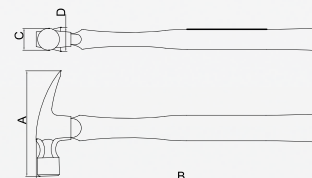

**Produto para
exportação**

40710 Martelo de Unha Framing Hammer Martillo de Uña Recta

REF.	Peso Weight	EAN 789.1114	Embalagem Package Embalaje			Dimensões Dimensions (mm)			
			Un.	KG	Comp x larg x alt Length x width x height Largo x ancho x altura	A	B	C	D
40710/016 •	16oz	04281 8	6	2,50	368 x 190 x 97mm	140	320	28,5	31
40710/020 •	20oz	04282 5	6	2,60	368 x 190 x 97mm	150	325	30	34
40710/022 •	22oz	00947 7	6	5,50	357 x 215 x 130mm	155	325	32	34

Pescoço octogonal.
Cabeça forjada e temperada em aço carbono especial.
Acabamento polido e envernizado.
Cabo de fibra de vidro fixado com epóxi e pino elástico.
Empunhadura de PVC.

IPI 8% incluso - NCM: 8205.20.00

Octogonal neck.
Forged and hardened carbon steel head.
Polished and varnished head.
Fiberglass handle fixed with epoxy and elastic safety pin.
Injected PVC grip.

*Cuello octogonal.
Cabeza forjada en acero carbono y templada.
Cabeza pulida y barnizada.
Mango de fibra de vidrio fijado con epoxi y perno elástico de seguridad.
Empuñadura de PVC inyectado.*

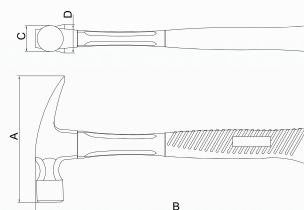

**Produto para
exportação**

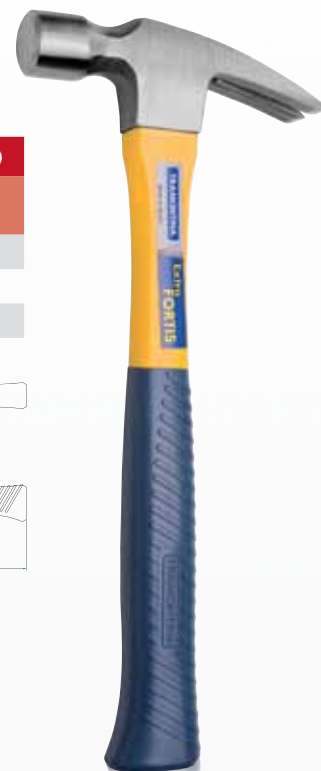

40892 Martelo de Unha Framing Hammer Martillo de Uña Recta

REF.	Peso Weight	EAN 789.1114	Embalagem Package Embalaje			Dimensões Dimensions (mm)			
			Un.	KG	Comp x larg x alt Length x width x height Largo x ancho x altura	A	B	C	D
40892/016 •	16oz	04476 8	12	9,23	400 x 245 x 140mm	141	337	28	34
40892/020 •	20oz	04477 5	12	10,80	395 x 245 x 165mm	150	337	31	36

Pescoço octogonal.
Cabeça forjada e temperada em aço carbono especial.
Acabamento jateado e cabeça envernizada.
Cabo de aço temperado.
Comprimento do cabo: 28,5cm

IPI 8% incluso - NCM: 8205.20.00

Octogonal neck.
Forged and hardened carbon steel head.
Sand blasted and varnished head.
Carbon steel tubular handle.
Handle length: 28,5cm

*Cuello octogonal.
Cabeza forjada en acero carbono y templada.
Acabado jateado y cabeza barnizada.
Mango tubular de acero carbono.
Extensión del mango: 28,5cm*

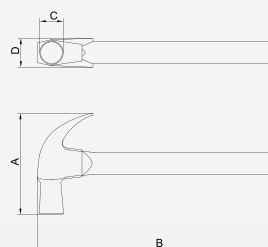

**Produto para
exportação**





40893 Martelo de Unha
Framing Hammer
Martillo de Uña Recta

REF.	Peso Weight	EAN 789.1114	Embalagem Package Embalaje			Dimensões Dimensions (mm)			
			Un.	KG	Comp x larg x alt Length x width x height Largo x ancho x altura	A	B	C	D
40893/020 •	20oz	04478 2	12	12,42	525 x 245 x 160mm	150	468	31	36

Pescoço octogonal.
Cabeça forjada e temperada em aço carbono especial.
Acabamento jateado e cabeça envernizada.
Cabo de aço temperado.
Comprimento do cabo: 43cm

IPI 8% incluso - NCM: 8205.20.00

Octogonal neck.
Forged and hardened carbon steel head.
Sand blasted and varnished head.
Carbon steel tubular handle.
Handle length: 43cm

Cuello octogonal.
Cabeza forjada en acero carbono y templada.
Acabado jateado y cabeza barnizada.
Mango tubular de acero carbono.
Extensión del mango: 43cm

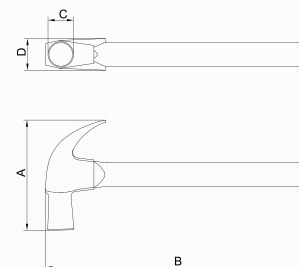

**Produto para
exportação**



40351 Martelo de Unha
Claw Hammer
Martillo de Uña

REF.	Peso Weight	EAN 789.1114	Embalagem Package Embalaje			Dimensões Dimensions (mm)			
			Un.	KG	Comp x larg x alt Length x width x height Largo x ancho x altura	A	B	C	D
40351/000	120g	00072 6	12	1,74	320 x 160 x 80mm	74	240	15,5	21

Cabeça forjada e temperada em aço carbono especial.
Acabamento jateado e cabeça envernizada.
Cabo em madeira envernizada.

IPI 8% incluso - NCM: 8205.20.00

Forged and hardened carbon steel head.
Sand blasted and varnished head.
Self-fixed hardwood handle.

Cabeza forjada en acero carbono y templada.
Acabado jateado y cabeza barnizada.
Mango de madera auto fijable.

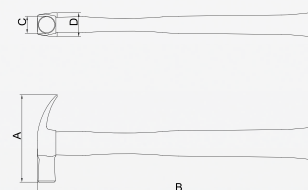

40365 Martelo de Unha Claw Hammer Martillo de Uña

REF.	Peso Weight	EAN 789.1114	Embalagem Package Embalaje			Dimensões Dimensions (mm)			
			Un.	KG	Comp x larg x alt Length x width x height Largo x ancho x altura	A	B	C	D
40365/001 •	420g	00811 1	12	6,59	285 x 320 x 120mm	106	310	34,5	17
40365/002 •	520g	00812 8	12	8,15	340 x 310 x 130mm	109	310	37	17
40365/003 •	620g	00813 5	12	9,09	340 x 310 x 130mm	124	330	40	17
40365/004 •	890g	06062 1	12	13,10	397 x 322 x 160mm	143,5	350	42	35

Cabeça forjada e temperada em aço carbono especial.
Acabamento com pintura eletrostática na cor preta.
Cabo em madeira envernizada.

IPI 8% incluso - NCM: 8205.20.00

Forged and hardened carbon steel head.
Black electrostatic painting.
Self-fixed hardwood handle.

*Cabeza forjada en acero carbono y templada.
Pintura electrostática negra.
Mango de madera auto fijable.*

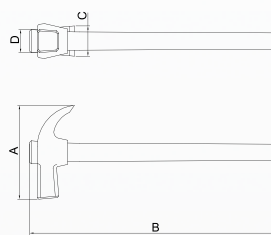

Produto para exportação

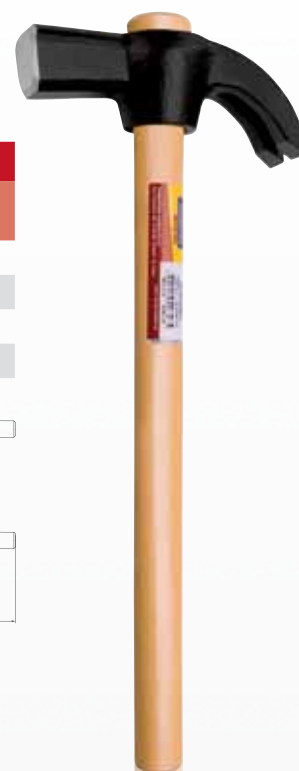

40355 Martelo de Unha Coffer Hammer Martillo de Uña Recta

REF.	Peso Weight	EAN 789.1114	Embalagem Package Embalaje			Dimensões Dimensions (mm)			
			Un.	KG	Comp x larg x alt Length x width x height Largo x ancho x altura	A	B	C	D
40355/000 •	690g	00403 8	12	11,31	465 x 280 x 150mm	170	370	40	30
40355/001 •	850g	06443 8	12	13,10	425 x 297 x 180mm	163	373	42	30

Cabeça forjada e temperada em aço carbono especial.
Acabamento com pintura eletrostática na cor preta.
Cabo em madeira envernizada.

IPI 8% incluso - NCM: 8205.20.00

Forged and hardened carbon steel head.
Black electrostatic painting.
Self-fixed hardwood handle.

*Cabeza forjada en acero carbono y templada.
Pintura electrostática negra.
Mango de madera auto fijable.*

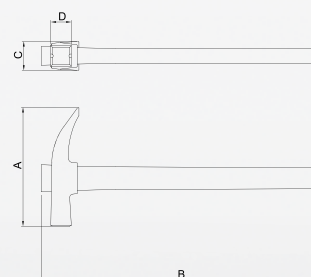

Produto para exportação

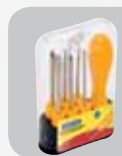
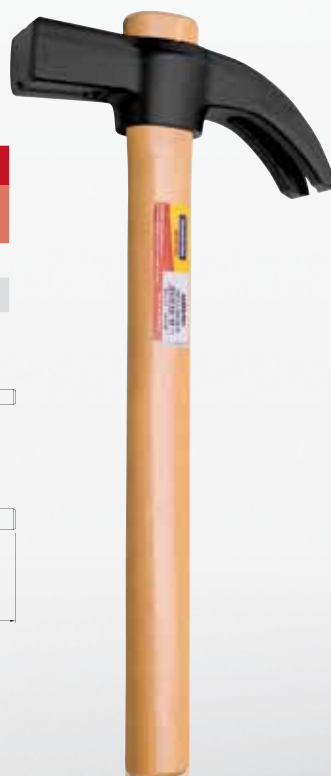



40711 Martelo de Unha
Coffer Hammer
Martillo de Uña Recta

REF.	Peso Weight	EAN 789.1114	Embalagem Package Embalaje			Dimensões Dimensions (mm)			
			Un.	KG	Comp x larg x alt Length x width x height Largo x ancho x altura	A	B	C	D
40711/000 •	690g	03632 9	6	5,82	400 x 215 x 120mm	168	368	30,5	40,5

Cabeça forjada e temperada em aço carbono especial.
Acabamento com pintura eletrostática na cor preta.
Cabo de fibra de vidro.
Empunhadura de PVC.

IPI 8% incluso - NCM: 8205.20.00

Forged and hardened carbon steel head.
Black electrostatic painting.
Self-fixed fiberglass handle.
Injected PVC grip.

*Cabeza forjada en acero carbono y templada.
Pintura electrostática negra.
Mango de fibra de vidrio autofijable.
Empuñadura de PVC inyectado.*

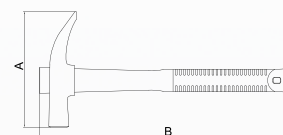

**Produto para
exportação**



40360 Martelo de Unha
Claw Hammer
Martillo de Uña

REF.	Peso Weight	EAN 789.1114	Embalagem Package Embalaje			Dimensões Dimensions (mm)			
			Un.	KG	Comp x larg x alt Length x width x height Largo x ancho x altura	A	B	C	D
40360/001	300g	00856 2	12	6,75	480 x 285 x 165mm	128	450	38	24,5
40360/002	400g	00857 9	12	8,49	480 x 285 x 165mm	138	450	42	27,5
40360/003	500g	00858 6	12	9,82	480 x 285 x 165mm	144,5	450	44	28,8

Cabeça forjada e temperada em aço carbono especial.
Acabamento com pintura eletrostática na cor preta.
Cabo em madeira envernizada.

IPI 8% incluso - NCM: 8205.20.00

Forged and hardened carbon steel head.
Black electrostatic painting.
Self-fixed hardwood handle.

*Cabeza forjada en acero carbono y templada.
Pintura electrostática negra.
Mango de madera auto fijable.*



**Produto para
exportação**

40410 Martelo de Bola - Basic
Ball Pein Hammer
Martillo de Bola

REF.	Peso Weight	EAN 789.1114	Embalagem Package Embalaje			Dimensões Dimensions (mm)			
			Un.	Peso	Comp x larg x alt Length x width x height Largo x ancho x altura	A	B	C	D
40410/004	100g	04522 2	12	2,50	320 x 155 x 80mm	64	285	17,5	20
40410/008	200g	04523 9	12	4,30	343 x 175 x 92mm	81	310	22	25
40410/012	300g	04524 6	12	5,40	368 x 190 x 97mm	87	320	24	28
40410/016	400g	04525 3	12	4,37	370 x 195 x 100mm	103	350	26,5	31
40410/020	500g	04526 0	12	9,30	403 x 223 x 122mm	110	355	29,5	34
40410/024	600g	04527 7	12	11,00	438 x 250 x 126mm	115	360	31,5	36,5
40410/032	800g	04528 4	6	7,00	425 x 160 x 130mm	125	380	34	40,5
40410/040	1.000g	04529 1	6	8,20	480 x 155 x 125mm	135	400	35,5	43

Cabeça forjada e temperada em aço carbono especial.
Acabamento jateado e cabeça envernizada.
Cabo em madeira envernizada fixado com cunha metálica.

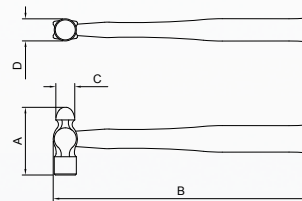

IPI 8% incluso - NCM: 8205.20.00

Forged and hardened carbon steel head.
Sand blasted and varnished head.
Hardwood handle fixed with steel wedge.

Cabeza forjada en acero carbono y templada.
Acabado jateado y cabeza barnizada.
Mango de madera fijado con cuña metálica.

40430 Martelo Vidraceiro
Glazier's Hammer
Martillo Vidriero

REF.	Peso Weight	EAN 789.1114	Embalagem Package Embalaje			Dimensões Dimensions (mm)			
			Un.	Peso	Comp x larg x alt Length x width x height Largo x ancho x altura	A	B	C	D
40430/000	50g	00383 3	12	1,23	275 x 95 x 80mm	75	250	12	10,5

Cabeça forjada e temperada em aço carbono especial.
Acabamento polido e envernizado.
Cabo em madeira envernizada.

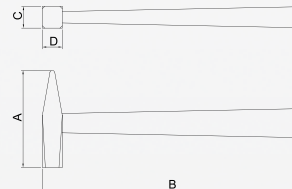

IPI 8% incluso - NCM: 8205.20.00

Forged and hardened carbon steel head.
Polished and varnished head.
Self-fixed hardwood handle.

Cabeza forjada en acero carbono y templada.
Cabeza pulida y barnizada.
Mango de madera auto fijable.

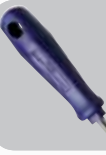



40443 Martelo de Pena - Basic
Machinist's Hammer
Martillo de Pena

REF.	Peso Weight	EAN 789.1114	Embalagem Package Embalaje			Dimensões Dimensions (mm)		
			Un.	Peso	Comp x larg x alt Length x width x height Largo x ancho x altura	A	B	C
40443/001	50g	06576 3	12	1,40	275 x 100 x 86mm	75	250	11
40443/002	100g	06577 0	12	2,40	320 x 155 x 80mm	82	260	15
40443/003	150g	06578 7	12	2,98	343 x 175 x 92mm	88	280	17
40443/004	200g	06579 4	12	3,43	343 x 175 x 92mm	95	280	19
40443/005	300g	06580 0	12	5,25	332 x 208 x 115mm	105	300	23
40443/006	400g	06581 7	12	6,89	370 x 165 x 142mm	112	320	25
40443/007	500g	06582 4	12	8,03	357 x 215 x 130mm	118	320	27
40443/008	600g	06583 1	12	9,60	380 x 235 x 135mm	122	330	29
40443/009	800g	06584 8	12	12,53	400 x 245 x 140mm	130	350	33
40443/010	1.000g	06585 5	12	15,53	435 x 255 x 125mm	135	360	36
40443/011	1.500g	06586 2	6	11,06	445 x 155 x 160mm	145	380	42
40443/012	2.000g	06587 9	6	13,70	465 x 170 x 173mm	155	400	47

Cabeça forjada e temperada em aço carbono especial.
Acabamento jateado e cabeça envernizada.
Cabo em madeira envernizada fixado com cunha metálica.

IPI 8% incluso - NCM: 8205.20.00

Forged and hardened carbon steel head.
Sand blasted and varnished head.
Hardwood handle fixed with steel wedge.

*Cabeza forjada en acero carbono y templada.
Acabado jateado y cabeza barnizada.
Mango de madera fijado con cuña metálica.*

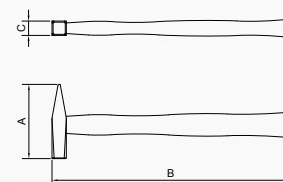

40401 Martelo Tapeceiro
Pin Hammer
Martillo Tapicero

REF.	Peso Weight	EAN 789.1114	Embalagem Package Embalaje			Dimensões Dimensions (mm)		
			Un.	KG	Comp x larg x alt Length x width x height Largo x ancho x altura	A	B	C
40401/000 •	4oz	00419 9	12	2,28	350 x 175 x 90mm	101,75	335	20

Cabeça forjada e temperada em aço carbono especial.
Acabamento polido e envernizado.
Cabo em madeira envernizada fixado com epóxi.

IPI 8% incluso - NCM: 8205.20.00

Forged and hardened carbon steel head.
Polished and varnished head.
Hardwood handle fixed with epoxy.

*Cabeza forjada en acero carbono y templada.
Cabeza pulida y barnizada.
Mango de madera fijado con epoxi*

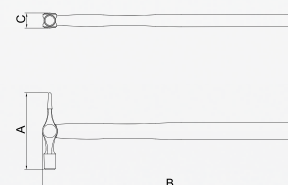

**Produto para
exportação**

40402 Martelo Pena Cruzada Cross Pein Hammer Martillo Pena Cruzada

REF.	Peso Weight	EAN 789.1114	Embalagem Package Embalaje			Dimensões Dimensions (mm)		
			Un.	KG	Comp x larg x alt Length x width x height Largo x ancho x altura	A	B	C
40402/006 •	6oz	00420 5	12	3,53	320 x 190 x 100mm	96	280	25,5
40402/008 •	8oz	00421 2	12	4,62	335 x 210 x 115mm	102	280	29
40402/012 •	12oz	00422 9	12	6,95	360 x 210 x 130mm	121	308	32

Cabeça forjada e temperada em aço carbono especial.
Acabamento polido e envernizado.
Cabo em madeira envernizada fixado com epóxi.

IPI 8% incluso - NCM: 8205.20.00

Forged and hardened carbon steel head.
Polished and varnished head.
Hardwood handle fixed with epoxy.

Cabeza forjada en acero carbono y templada.
Cabeza pulida y barnizada.
Mango de madera fijado con epoxi

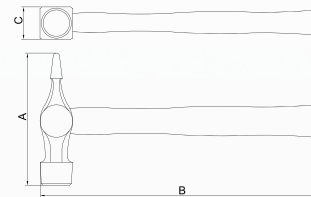

**Produto para
exportação**



40441 Martelo de Pena Machinist's Hammer (Rivoir) Martillo de Pena

REF.	Tamanho Size Tamaño	EAN 789.1114	Embalagem Package Embalaje			Dimensões Dimensions (mm)			
			Un.	Peso	Comp x larg x alt Length x width x height Largo x ancho x altura	A	B	C	D
40441/025 •	25mm	00415 1	12	4,61	360 x 210 x 130mm	85	300	22	25
40441/028 •	28mm	05274 9	12	5,67	360 x 210 x 130mm	88	320	24	28
40441/030 •	30mm	00416 8	12	6,87	360 x 210 x 130mm	94	320	25	30
40441/032 •	32mm	05275 6	12	7,93	400 x 215 x 120mm	100	350	27	32
40441/035 •	35mm	00417 5	12	9,32	435 x 255 x 125mm	105	350	30	35
40441/040 •	40mm	00418 2	12	12,77	435 x 255 x 125mm	115	360	35	40
40441/045 •	45mm	00786 2	12	18,20	420 x 300 x 175mm	129	360	40	45
40441/050 •	50mm	05276 3	12	21,98	460 x 280 x 150mm	138	380	44	50

Cabeça forjada e temperada em aço carbono especial.
Acabamento com pintura eletrostática na cor preta.
Cabo em madeira envernizada fixado com epóxi.

IPI 8% incluso - NCM: 8205.20.00

Forged and hardened carbon steel head.
Black electrostatic painting.
Hardwood handle fixed with epoxy.

Cabeza forjada en acero carbono y templada.
Pintura electrostática negra.
Mango de madera fijado con epoxi.

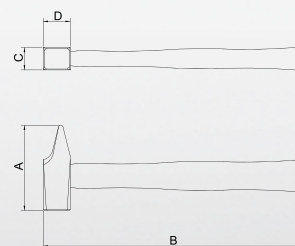

**Produto para
exportação**

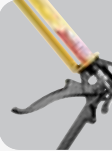
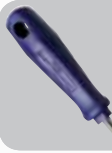



40731 Martelo de Pena Machinist's Hammer (Rivoir) Martillo de Pena

REF.	Tamanho Size <i>Tamaño</i>	EAN 789.1114	Embalagem Package <i>Embalaje</i>			Dimensões Dimensions (mm)			
			Un.	Peso	Comp x larg x alt Length x width x height <i>Largo x ancho x altura</i>	A	B	C	D
40731/025 •	25mm	03639 8	6	2,38	340 x 95 x 95mm	85	285	22	25
40731/030 •	30mm	03640 4	6	3,54	380 x 100 x 150mm	94	320	25	30
40731/035 •	35mm	03641 1	6	4,50	403 x 223 x 122mm	105	350	30	35
40731/040 •	40mm	03642 8	6	6,77	360 x 210 x 130mm	115	355	35	40
40731/045 •	45mm	03643 5	6	9,35	380 x 220 x 135mm	129	360	40	45

Cabeça forjada e temperada em aço carbono especial.
Acabamento com pintura eletrostática na cor preta.
Cabo de fibra de vidro fixado com epóxi e pino elástico.
Empunhadura de PVC.

IPI 8% incluso - NCM: 8205.20.00

Forged and hardened carbon steel head.
Black electrostatic painting.
Fiberglass handle fixed with epoxy and elastic safety pin.
Injected PVC grip.

*Cabeza forjada en acero carbono y templada.
Pintura electrostática negra.
Mango de fibra de vidrio fijado con epoxi y perno elástico de seguridad.
Empuñadura de PVC inyectado.*

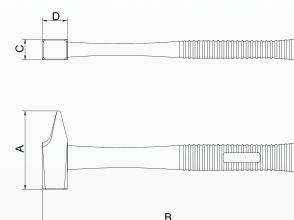

**Produto para
exportação**



40442 Martelo Carpinteiro Joiner's Hammer (Menuisier) Martillo Carpintero

REF.	Tamanho Size <i>Tamaño</i>	EAN 789.1114	Embalagem Package <i>Embalaje</i>			Dimensões Dimensions (mm)			
			Un.	Peso	Comp x larg x alt Length x width x height <i>Largo x ancho x altura</i>	A	B	C	D
40442/016 •	16mm	00264 5	12	2,44	280 x 190 x 110mm	76,5	262	16	20
40442/018 •	18mm	00265 2	12	3,08	320 x 190 x 100mm	85	282	17,5	22
40442/020 •	20mm	00266 9	12	3,96	320 x 190 x 100mm	90	282	19	23,5
40442/022 •	22mm	00267 6	12	4,79	335 x 210 x 115mm	100	302	21	26
40442/025 •	25mm	00268 3	12	6,19	360 x 210 x 130mm	105	302	24	29
40442/030 •	30mm	00269 0	12	9,52	380 x 220 x 135mm	122,5	320	27	35

Cabeça forjada e temperada em aço carbono especial.
Acabamento com pintura eletrostática na cor preta.
Cabo em madeira envernizada fixado com epóxi.

IPI 8% incluso - NCM: 8205.20.00

Forged and hardened carbon steel head.
Black electrostatic painting.
Hardwood handle fixed with epoxy.

*Cabeza forjada en acero carbono y templada.
Pintura electrostática negra.
Mango de madera fijado con epoxi.*

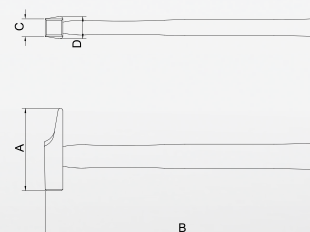

**Produto para
exportação**

40445 Martelo Eletricista Electrician's Hammer Martillo Electricista

REF.	Peso Weight	EAN 789.1114	Embalagem Package Embalaje			Dimensões Dimensions (mm)			
			Un.	KG	Comp x larg x alt Length x width x height Largo x ancho x altura	A	B	C	D
40445/016 •	140g	00386 4	12	3,82	335 x 210 x 115mm	126	260	14,2	16
40445/018 •	200g	00787 9	12	3,85	335 x 210 x 115mm	134	280	15	18,2

Cabeça forjada e temperada em aço carbono especial.
Acabamento com pintura eletrostática na cor preta.
Cabo em madeira envernizada fixado com epóxi.

IPI 8% incluso - NCM: 8205.20.00

Forged and hardened carbon steel head.
Black electrostatic painting.
Hardwood handle fixed with epoxy.

Cabeza forjada en acero carbono y templada.
Pintura electrostática negra.
Mango de madera fijado con epoxi.

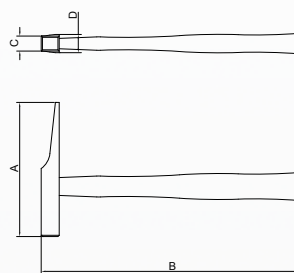

Produto para
exportação



40732 Martelo Carpinteiro Joiner's Hammer (Menuisier) Martillo Carpintero

REF.	Tamanho Size Tamaño	EAN 789.1114	Embalagem Package Embalaje			Dimensões Dimensions (mm)			
			Un.	Peso	Comp x larg x alt Length x width x height Largo x ancho x altura	A	B	C	D
40732/016 •	16mm	03644 2	6	1,32	330 x 110 x 75mm	76,5	260	16	16,5
40732/018 •	18mm	03645 9	6	1,73	330 x 110 x 75mm	85	280	17,5	18
40732/020 •	20mm	03646 6	6	1,96	330 x 110 x 75mm	90	280	19	19,4
40732/022 •	22mm	03647 3	6	2,55	365 x 125 x 80mm	100	300	21	21,5
40732/025 •	25mm	03648 0	6	3,13	365 x 125 x 80mm	105	300	24	25,5
40732/030 •	30mm	03649 7	6	4,83	380 x 100 x 150mm	122,5	320	27	29,7

Cabeça forjada e temperada em aço carbono especial.
Acabamento com pintura eletrostática na cor preta.
Cabo em madeira envernizada fixado com epóxi.

IPI 8% incluso - NCM: 8205.20.00

Forged and hardened carbon steel head.
Black electrostatic painting.
Fiberglass handle fixed with epoxy and elastic safety pin.
Injected PVC grip.

Cabeza forjada en acero carbono y templada.
Pintura electrostática negra.
Mango de fibra de vidrio fijado con epoxi y perno elástico de seguridad.
Empuñadura de PVC inyectado.

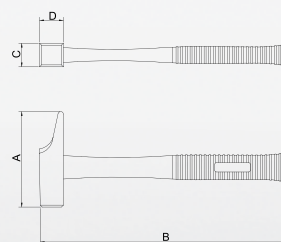

Produto para
exportação

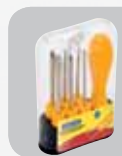



40733 Martelo Eletricista Electrician's Hammer Martillo Electricista

REF.	Peso Weight	EAN 789.1114	Embalagem Package Embalaje			Dimensões Dimensions (mm)			
			Un.	KG	Comp x larg x alt Length x width x height Largo x ancho x altura	A	B	C	D
40733/016 •	140g	03650 3	6	1,60	305 x 135 x 70mm	126	260	14,2	16
40733/018 •	200g	03651 0	6	2,03	320 x 160 x 80mm	128	280	15	18

Cabeça forjada e temperada em aço carbono especial.
Acabamento com pintura eletrostática na cor preta.
Cabo em madeira envernizada fixado com epóxi.

IPI 8% incluso - NCM: 8205.20.00

Forged and hardened carbon steel head.
Black electrostatic painting.
Fiberglass handle fixed with epoxy and elastic safety pin.
Injected PVC grip.

*Cabeza forjada en acero carbono y templada.
Pintura electrostática negra.
Mango de fibra de vidrio fijado con epoxi y perno elástico de seguridad.
Empuñadura de PVC inyectado.*

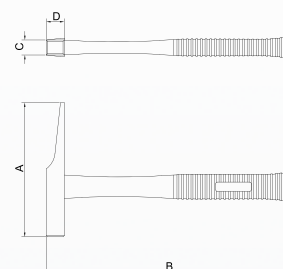

**Produto para
exportação**



40455 Martelo Picador de Solda Welder's Hammer Martillo de Pico para Soldadura

REF.	Peso Weight	EAN 789.1114	Embalagem Package Embalaje		Dimensões Dimensions (mm)			
			Un.	Peso	Comp x larg x alt Length x width x height Largo x ancho x altura	A	B	C
40455/000	290g	00395 6	12	5,44	360 x 210 x 130mm	177	280	21

Cabeça forjada e temperada em aço carbono especial.
Acabamento com pintura eletrostática na cor preta.
Cabo em madeira envernizada fixado com cunha metálica.

IPI 8% incluso - NCM: 8205.20.00

Forged and hardened carbon steel head.
Black electrostatic painting.
Hardwood handle fixed with steel wedge.

*Cabeza forjada en acero carbono y templada.
Pintura electrostática negra.
Mango de madera fijado con cuña metálica.*

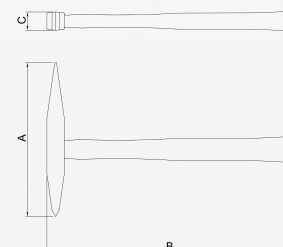

40456 Martelo Pedreiro
Brick Hammer
Martillo Albañil

REF.	Peso Weight	EAN 789.1114	Embalagem Package Embalaje		Dimensões Dimensions (mm)				
			Un.	Peso	Comp x larg x alt Length x width x height Largo x ancho x altura	A	B	C	D
40456/018	500g	00358 1	12	7,73	435 x 255 x 125mm	174	280	24	30
40456/024	680g	00390 1	12	11,44	445 x 280 x 140mm	202	280	27,5	35

Cabeça forjada e temperada em aço carbono especial.
Acabamento com pintura eletrostática na cor preta.
Cabo em madeira envernizada fixado com epóxi.

IPI 8% incluso - NCM: 8205.20.00

Forged and hardened carbon steel head.
Black electrostatic painting.
Hardwood handle fixed with epoxy.

Cabeza forjada en acero carbono y templada.
Pintura electrostática negra.
Mango de madera fijado con epoxi.

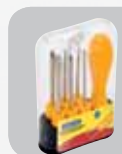
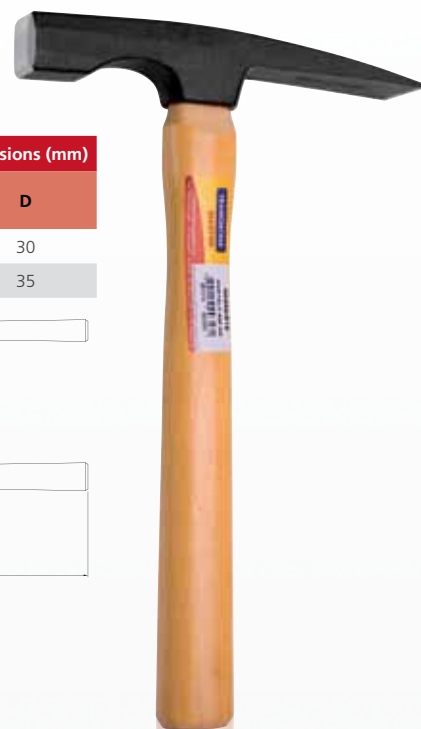
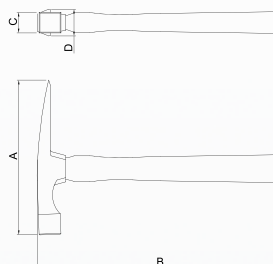

40458 Martelo Pedreiro - 2 cortes
Brick Hammer - Double cut
Martillo Albañil - Doble cortes

REF.	Peso Weight	EAN 789.1114	Embalagem Package Embalaje		Dimensões Dimensions (mm)				
			Un.	Peso	Comp x larg x alt Length x width x height Largo x ancho x altura	A	B	C	D
40458/000	500g	00275 1	12	8,90	445 x 280 x 140mm	205	340	47	31,5

Cabeça forjada e temperada em aço carbono especial.
Acabamento jateado e cabeça envernizada.
Cabo em madeira envernizada fixado com epóxi.

IPI 8% incluso - NCM: 8205.20.00

Forged and hardened carbon steel head.
Sand blasted and varnished head.
Hardwood handle fixed with epoxy.

Cabeza forjada en acero carbono y templada.
Acabado jateado y cabeza barnizada.
Mango de madera fijado con epoxi.

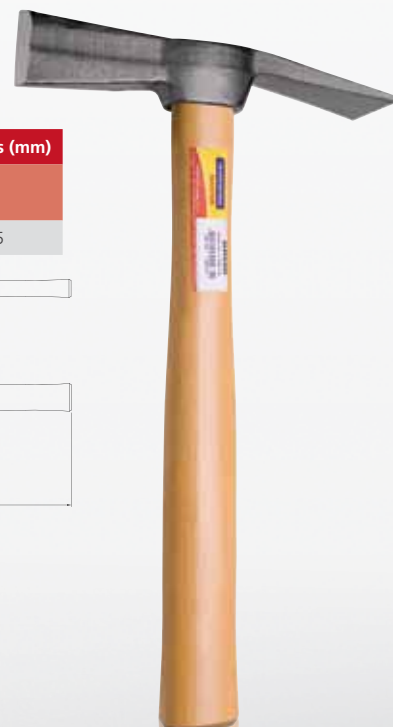
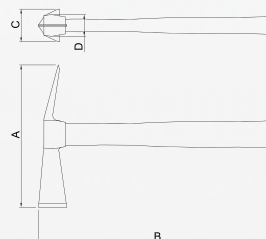



40457 Martelo Picador
Chipping Hammer
Martillo Picador

REF.	Peso Weight	EAN 789.1114	Embalagem Package Embalaje			Dimensões Dimensions (mm)			
			Un.	KG	Comp x larg x alt Length x width x height Largo x ancho x altura	A	B	C	D
40457/016	160z	00423 6	6	3,70	343 x 175 x 92mm	130	320	29	25
40457/020	20oz	00424 3	6	4,50	380 x 160 x 123mm	140	320	33	28

Cabeça forjada e temperada em aço carbono especial.
Acabamento com pintura eletrostática na cor preta.
Cabo em madeira envernizada fixado com epóxi.

IPI 8% incluso - NCM: 8205.20.00

Forged and hardened carbon steel head.
Black electrostatic painting.
Hardwood handle fixed with epoxy.

Cabeza forjada en acero carbono y templada.
Pintura electrostática negra.
Mango de madera fijado con epoxi.

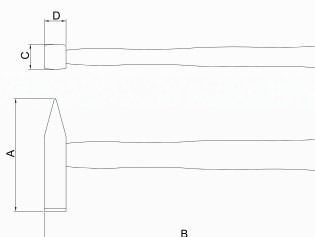

**Produto para
exportação**



40740 Martelo Ponta e Pá - Extra Fortis
Flat and Pointed Hammer
Martillo con Cabeza Chata y Punta

REF.	Peso Weight	EAN 789.1114	Embalagem Package Embalaje			Dimensões Dimensions (mm)		
			Un.	Peso	Comp x larg x alt Length x width x height Largo x ancho x altura	A	B	C
40740/001	500g	06952 5	6	4,42	360 x 120 x 130mm	190	348	46,5

Cabeça forjada e temperada em aço carbono especial.
Acabamento jateado e cabeça envernizada.
Cabo de fibra de vidro fixado com epóxi e pino elástico.
Empunhadura injetada.

IPI 8% incluso - NCM: 8205.20.00

Forged and hardened carbon steel head.
Sand blasted and varnished head.
Fiberglass handle fixed with epoxy and elastic safety pin.
Injected PVC grip.

Cabeza forjada en acero carbono y templada.
Acabado jateado y cabeza barnizada.
Mango de fibra de vidrio fijado con epoxi y perno elástico de seguridad.
Empuñadura de PVC inyectado.

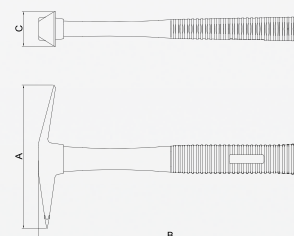

40450 Martelo Tapeceiro Magnetic Tack Hammer Martillo Tapicero

REF.	Peso Weight	EAN 789.1114	Embalagem Package Embalaje			Dimensões Dimensions (mm)			
			Un.	Peso	Comp x larg x alt Length x width x height Largo x ancho x altura	A	B	C	D
40450/000 •	140g	00389 5	12	2,85	350 x 175 x 90mm	100	280	21	16

Cabeça forjada e temperada em aço carbono especial.
Pena imantada.
Acabamento com pintura eletrostática na cor preta.
Cabo em madeira envernizada fixado com epóxi.

IPI 8% incluso - NCM: 8205.20.00

Forged and hardened carbon steel head.
Magnetized pein.
Black electrostatic painting.
Hardwood handle fixed with epoxy.

*Cabeza forjada en acero carbono y templada.
Pena imantada.
Pintura electrostática negra.
Mango de madera fijado con epoxi.*

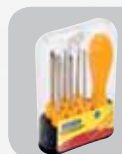
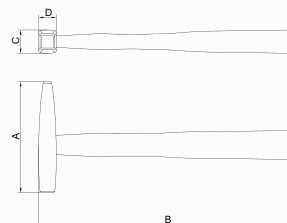

40460 Martelo Sapateiro Shoemaker's Hammer Martillo Zapatero

REF.	Peso Weight	EAN 789.1114	Embalagem Package Embalaje			Dimensões Dimensions (mm)		
			Un.	Peso	Comp x larg x alt Length x width x height Largo x ancho x altura	A	B	C
40460/000	350g	00391 8	12	5,96	300 x 250 x 145mm	155	243	35

Cabeça forjada e temperada em aço carbono especial.
Acabamento com pintura eletrostática na cor preta.
Cabo em madeira envernizada fixado com epóxi.

IPI 8% incluso - NCM: 8205.20.00

Forged and hardened carbon steel head.
Black electrostatic painting.
Hardwood handle fixed with epoxy.

*Cabeza forjada en acero carbono y templada.
Pintura electrostática negra.
Mango de madera fijado con epoxi.*

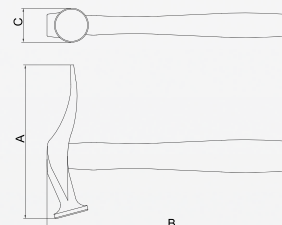



40682 Martelo de Borracha Branca - Modelo Americano
Rubber Mallet - American type
Martillo de Goma - Modelo Americano

REF.	Peso Weight	EAN 789.1114	Embalagem Package Embalaje			Dimensões Dimensions (mm)		
			Un.	Peso	Comp x larg x alt Length x width x height Largo x ancho x altura	A	B	C
40682/008	225g	05993 9	6	2,73	370 x 195 x 100mm	79	310	53,5
40682/016	450g	05994 6	6	4,39	400 x 245 x 140mm	94,5	340	62

Cabeça de borracha branca.
Cabo em madeira envernizado.

PI 18% incluso - NCM: 4016.99.90

White rubber head.
Hardwood handle.

Cabeza de goma branca.
Mango de madeira.

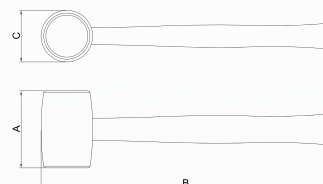

40508 Marreta Oitavada - Basic
Engineer's Hammer
Maza Octavada

REF.	Peso Weight	EAN 789.1114	Embalagem Package Embalaje			Dimensões Dimensions (mm)			
			Un.	Peso	Comp x larg x alt Length x width x height Largo x ancho x altura	A	B	C	D
40508/001	500g	08861 8	6	4,16	320 x 160 x 80mm	84	255	34,5	32,5
40508/002	1.000g	07707 0	6	6,91	320 x 145 x 115mm	100	255	42,5	40
40508/003	1.500g	07708 7	6	9,59	350 x 150 x 140mm	118	280	47	44
40508/004*	2.000g	09374 2	6	13,5	370 x 165 x 110mm	128	300	53	50

Cabeça forjada e temperada em aço carbono especial.
Acabamento jateado e cabeça envernizada.
Cabo em madeira envernizada fixado com cunha metálica.

IPI 8% incluso - NCM: 8205.20.00

Forged and hardened carbon steel head.
Sand blasted and varnished head.
Hardwood handle fixed with steel wedge.

Cabeza forjada en acero carbono y templada.
Acabado jateado y cabeza barnizada.
Mango de madera fijado con cuña metálica.

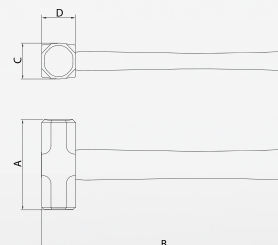

40501 Marreta Oitavada
Engineer's Hammer
Maza Octogonal

REF.	Peso Weight	EAN 789.1114	Embalagem Package Embalaje			Dimensões Dimensions (mm)			
			Un.	KG	Comp x larg x alt Length x width x height Largo x ancho x altura	A	B	C	D
40501/002	1.000g	00430 4	6	7,39	480 x 160 x 120mm	100	395	42,5	40
40501/003	1.500g	00431 1	6	10,23	480 x 160 x 120mm	118	395	47	44
40501/004	2.000g	00432 8	6	13,49	480 x 200 x 140mm	128	395	53	50

Cabeça forjada e temperada em aço carbono especial.
Acabamento jateado e cabeça envernizada.
Cabo em madeira envernizada fixado com cunha metálica.

IPI 8% incluso - NCM: 8205.20.00

Forged and hardened carbon steel head.
Sand blasted and varnished head.
Hardwood handle fixed with steel wedge.

Cabeza forjada en acero carbono y templada.
Acabado jateado y cabeza barnizada.
Mango de madera fijado con cuña metálica.

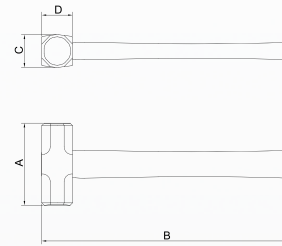

Produto para exportação

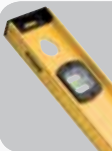
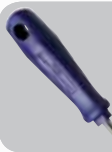

40502 Marreta Quadrada
Drilling Hammer
Maza Cuadrada

REF.	Peso Weight	EAN 789.1114	Embalagem Package Embalaje			Dimensões Dimensions (mm)		
			Un.	KG	Comp x larg x alt Length x width x height Largo x ancho x altura	A	B	C
40502/002	1.200g	00131 0	6	7,31	330 x 150 x 130mm	105	255	44
40502/003	1.500g	00433 5	6	9,51	330 x 150 x 130mm	120	255	50,5
40502/004	2.000g	00434 2	6	12,60	365 x 170 x 135mm	125	255	55,5

Cabeça forjada e temperada em aço carbono especial.
Acabamento jateado e cabeça envernizada.
Cabo em madeira envernizada fixado com cunha metálica.

IPI 8% incluso - NCM: 8205.20.00

Forged and hardened carbon steel head.
Sand blasted and varnished head.
Hardwood handle fixed with steel wedge.

Cabeza forjada en acero carbono y templada.
Acabado jateado y cabeza barnizada.
Mango de madera fijado con cuña metálica.

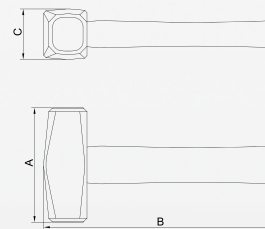

Produto para exportação

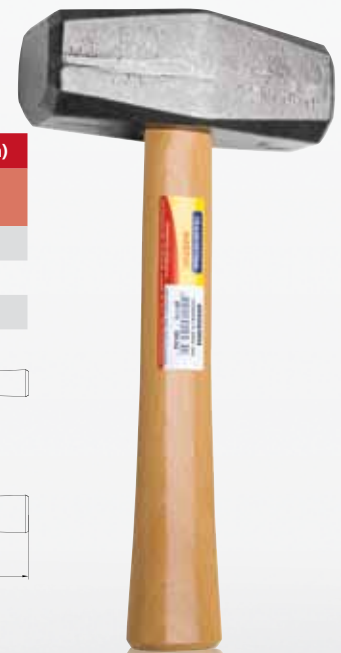



40503 Marreta Quadrada
Club Hammer
Maza Cuadrada

REF.	Peso Weight	EAN 789.1114	Embalagem Package Embalaje			Dimensões Dimensions (mm)			
			Un.	KG	Comp x larg x alt Length x width x height Largo x ancho x altura	A	B	C	D
40503/002	1.200g	00281 2	6	7,65	320 x 145 x 115mm	98	255	40	46,5
40503/003	1.500g	00282 9	6	8,95	320 x 145 x 115mm	105	255	43	49
40503/004	2.000g	00283 6	6	11,79	330 x 150 x 130mm	115	255	45	50

Cabeça forjada e temperada em aço carbono especial.
Acabamento jateado e cabeça envernizada.
Cabo em madeira envernizada fixado com cunha metálica.

IPI 8% incluso - NCM: 8205.20.00

Forged and hardened carbon steel head.
Sand blasted and varnished head.
Hardwood handle fixed with steel wedge.

Cabeza forjada en acero carbono y templada.
Acabado jateado y cabeza barnizada.
Mango de madera fijado con cuña metálica.

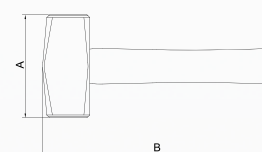

Produto para exportação



40504 Marreta Quadrada - Olho oval
Stoning Hammer - Oval eye
Maza Cuadrada - Ojo ovalado

REF.	Peso Weight	EAN 789.1114	Embalagem Package Embalaje			Dimensões Dimensions (mm)			
			Un.	KG	Comp x larg x alt Length x width x height Largo x ancho x altura	A	B	C	D
40504/000 •	800g	01689 5	6	6,44	320 x 190 x 100mm	88	262	40,5	37
40504/001 •	1.000g	00789 3	6	7,40	317 x 144 x 120mm	95	262	44,5	40
40504/002 •	1.250g	00790 9	6	9,06	330 x 150 x 130mm	100	262	47,5	43
40504/003 •	1.500g	00805 0	6	10,40	345 x 156 x 138mm	110	282	49,5	45
40504/004 •	2.000g	00806 7	6	12,00	370 x 165 x 142mm	120	302	55	50

Cabeça forjada e temperada em aço carbono especial.
Acabamento jateado e cabeça envernizada.
Cabo em madeira envernizada fixado com cunha metálica.

IPI 8% incluso - NCM: 8205.20.00

Forged and hardened carbon steel head.
Sand blasted and varnished head.
Hardwood handle fixed with steel wedge.

Cabeza forjada en acero carbono y templada.
Acabado jateado y cabeza barnizada.
Mango de madera fijado con cuña metálica.

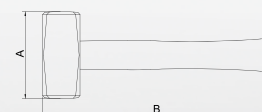

Produto para exportação

40505 Marreta Quadrada Stoning Hammer Maza Cuadrada

REF.	Peso Weight	EAN 789.1114	Embalagem Package Embalaje			Dimensões Dimensions (mm)			
			Un.	KG	Comp x larg x alt Length x width x height Largo x ancho x altura	A	B	C	D
40505/001 •	700g	00807 4	6	4,85	320 x 145 x 115mm	105,5	260	35	34
40505/002 •	1.000g	00808 1	6	7,10	325 x 155 x 135mm	125	270	40	40,5
40505/003 •	1.400g	00809 8	6	9,31	365 x 170 x 135mm	134	280	42,5	43,4

Cabeça forjada e temperada em aço carbono especial.
Acabamento jateado e cabeça envernizada.
Cabo em madeira envernizada fixado com cunha metálica.

IPI 8% incluso - NCM: 8205.20.00

Forged and hardened carbon steel head.
Sand blasted and varnished head.
Hardwood handle fixed with steel wedge.

*Cabeza forjada en acero carbono y templada.
Acabado jateado y cabeza barnizada.
Mango de madera fijado con cuña metálica.*

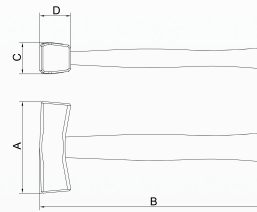

Produto para exportação

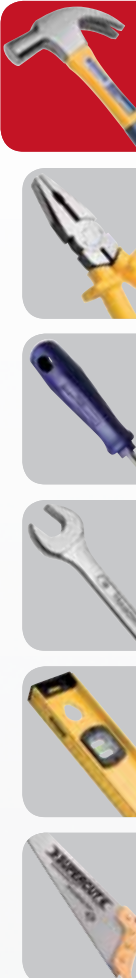
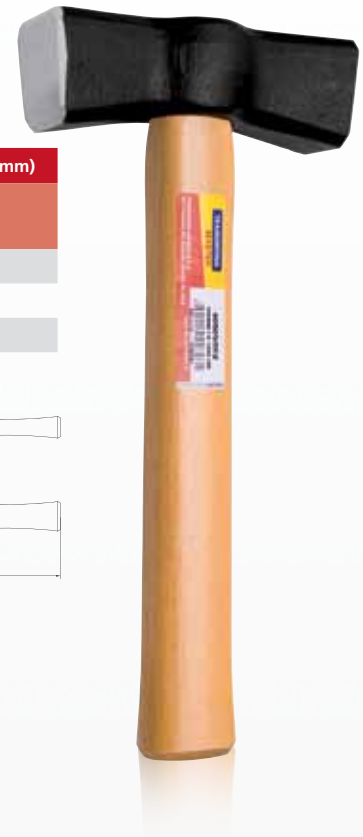

40723 Marreta Quadrada Stoning Hammer Maza Cuadrada

REF.	Peso Weight	EAN 789.1114	Embalagem Package Embalaje			Dimensões Dimensions (mm)		
			Un.	KG	Comp x larg x alt Length x width x height Largo x ancho x altura	A	B	C
40723/001 •	700g	03636 7	6	4,98	320 x 145 x 115mm	105	258	36
40723/002 •	1.000g	03637 4	6	7,66	330 x 150 x 130mm	120	268	39
40723/003 •	1.400g	03638 1	6	9,36	365 x 170 x 135mm	130	275	42

Cabeça forjada e temperada em aço carbono especial.
Acabamento jateado e cabeça envernizada.
Cabo de fibra de vidro fixado com epóxi e pino elástico.
Empunhadura injetada.

IPI 8% incluso - NCM: 8205.20.00

Forged and hardened carbon steel head.
Sand blasted and varnished head.
Fiberglass handle fixed with epoxy and elastic safety pin.
Injected PVC grip.

*Cabeza forjada en acero carbono y templada.
Acabado jateado y cabeza barnizada.
Mango de fibra de vidrio fijado con epoxi y perno elástico de seguridad.
Empuñadura de PVC inyectado.*

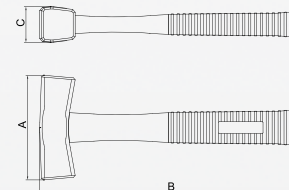

Produto para exportação

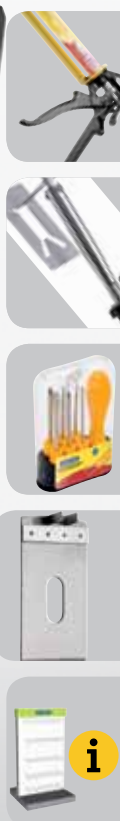



40722 Marreta Quadrada - Olho oval
Stoning Hammer - Oval eye
Maza Cuadrada - Ojo ovalado

REF.	Peso Weight	EAN 789.1114	Embalagem Package Embalaje			Dimensões Dimensions (mm)			
			Un.	KG	Comp x larg x alt Length x width x height Largo x ancho x altura	A	B	C	D
40722/000 •	800g	03633 6	6	6,02	280 x 190 x 110mm	88	260	40,5	37
40722/001 •	1.000g	03634 3	6	7,25	320 x 190 x 100mm	95	260	44,5	40
40722/002 •	1.250g	03635 0	6	8,60	320 x 190 x 100mm	100	260	47,5	43

Cabeça forjada e temperada em aço carbono especial.
Acabamento jateado e cabeça envernizada.
Cabo de fibra de vidro.
Empunhadura injetada.

IPI 8% incluso - NCM: 8205.20.00

Forged and hardened carbon steel head.
Sand blasted and varnished head.
Self-fixed fiberglass handle.
Injected PVC grip.

Cabeza forjada en acero carbono y templada.
Acabado jateado y cabeza barnizada.
Mango de fibra de vidrio autofijable.
Empuñadura de PVC inyectado.

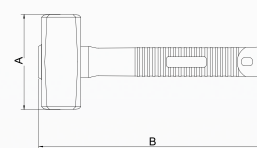
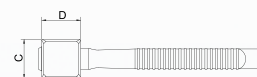

Produto para exportação



40510 Marreta Quadrada - Olho oval
Stoning Hammer - Oval eye
Maza Cuadrada - Ojo ovalado

REF.	Peso Weight	EAN 789.1114	Embalagem Package Embalaje			Dimensões Dimensions (mm)			
			Un.	KG	Comp x larg x alt Length x width x height Largo x ancho x altura	A	B	C	D
40510/000 •	800g	00798 5	6	2,98	320 x 145 x 115mm	88	270	38	38
40510/001 •	1.000g	00814 2	6	7,12	320 x 190 x 100mm	95	270	40	40
40510/002 •	1.250g	00788 6	6	8,40	345 x 156 x 138mm	100	270	43	43
40510/003 •	1.500g	00799 2	6	10,20	345 x 156 x 138mm	110	280	45	45
40510/004 •	2.000g	00951 4	6	13,5	370 x 165 x 142mm	120	320	50	50

Cabeça forjada e temperada em aço carbono especial.
Acabamento jateado e cabeça envernizada.
Cabo em madeira envernizada.

IPI 8% incluso - NCM: 8205.20.00

Forged and hardened carbon steel head.
Sand blasted and varnished head.
Self-fixed hardwood handle.

Cabeza forjada en acero carbono y templada.
Acabado jateado y cabeza barnizada.
Mango de madera autofijable.

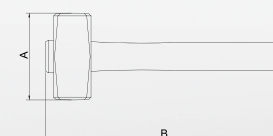

Produto para exportação

40561 Machadinha Profissional - DIN 5131
Hunter Axe - DIN 5131
Hachita Cazador - DIN 5131

REF.	Peso Weight	EAN 789.1114	Embalagem Package Embalaje			Dimensões Dimensions (mm)			
			Un.	Peso	Comp x larg x alt Length x width x height Largo x ancho x altura	A	B	C	D
40561/000	600g	00393 2	12	10,42	435 x 255 x 125mm	156	350	109	24

Cabeça forjada e temperada em aço carbono especial.
Acabamento com pintura eletrostática na cor preta.
Cabo em madeira envernizada fixado com cunha.

IPI 0% incluso - NCM: 8201.40.00

Forged and hardened carbon steel head.
Black electrostatic painting.
Hardwood handle fixed with steel wedge.

Cabeza forjada en acero carbono y templada.
Pintura electrostática negra.
Mango de madera fijado con cuña metálica.

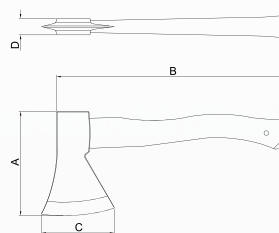

40564 Machadinha
Axe
Hachita

REF.	Peso Weight	EAN 789.1114	Embalagem Package Embalaje			Dimensões Dimensions (mm)		
			Un.	Peso	Comp x larg x alt Length x width x height Largo x ancho x altura	A	B	C
40564/000	600g	06860 3	6	5,82	380 x 160 x 120mm	155	385	30

Cabeça forjada e temperada em aço carbono especial.
Acabamento jateado e cabeça envernizada.
Cabo em madeira envernizada fixado com epóxi.

IPI 0% incluso - NCM: 8201.40.00

Forged and hardened carbon steel head.
Sand blasted and varnished head.
Hardwood handle fixed with epoxy.

Cabeza forjada en acero carbono y templada.
Acabado jateado y cabeza barnizada.
Mango de madera fijado con epoxi.

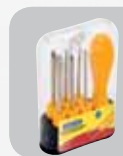
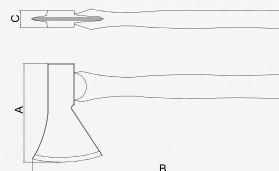



40550 Machadinha Caçador
Hunter Axe
Hachita Cazador

REF.	Peso Weight	EAN 789.1114	Embalagem Package Embalaje			Dimensões Dimensions (mm)			
			Un.	KG	Comp x larg x alt Length x width x height Largo x ancho x altura	A	B	C	D
40550/001 •	600g	00427 4	6	4,60	368 x 190 x 97mm	138,5	350	81	22
40550/002 •	700g	00428 1	6	5,00	368 x 190 x 97mm	138,5	380	86	23
40550/003 •	800g	00429 8	6	5,90	368 x 190 x 97mm	138,5	380	90	24

Cabeça forjada e temperada em aço carbono especial.
Acabamento polido e envernizado.
Cabo em madeira envernizada fixado com cunha.

IPI 0% incluso - NCM: 8201.40.00

Forged and hardened carbon steel head.
Polished and varnished head.
Hardwood handle fixed with steel wedge.

Cabeza forjada en acero carbono y templada.
Cabeza pulida y barnizada.
Mango de madera fijado con cuña metálica.

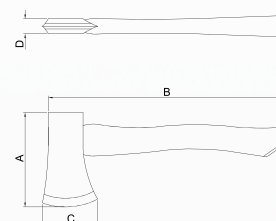

**Produto para
exportação**



40562 Machadinha Caçador
Hunter Axe
Hachita Cazador

REF.	Peso Weight	EAN 789.1114	Embalagem Package Embalaje			Dimensões Dimensions (mm)			
			Un.	KG	Comp x larg x alt Length x width x height Largo x ancho x altura	A	B	C	D
40562/001	600g	00394 9	6	3,58	370 x 195 x 100mm	138,5	350	81	22
40562/002	700g	00425 0	6	6,25	370 x 195 x 100mm	138,5	380	86	23
40562/003	800g	00426 7	6	6,72	370 x 195 x 100mm	138,5	380	90	24

Cabeça forjada e temperada em aço carbono especial.
Acabamento com pintura eletrostática na cor preta.
Cabo em madeira envernizada fixado com cunha.

IPI 0% incluso - NCM: 8201.40.00

Forged and hardened carbon steel head.
Black electrostatic painting.
Hardwood handle fixed with steel wedge.

Cabeza forjada en acero carbono y templada.
Pintura electrostática negra.
Mango de madera fijado con cuña metálica

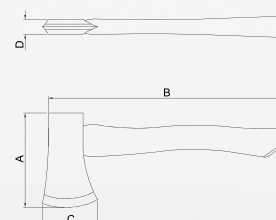

**Produto para
exportação**

40563 Machadinha
Half Hatchet
Hachita

REF.	Peso Weight	EAN 789.1114	Embalagem Package Embalaje			Dimensões Dimensions (mm)			
			Un.	KG	Comp x larg x alt Length x width x height Largo x ancho x altura	A	B	C	D
40563/001 •	1.1/2lb	04814 8	6	5,80	362 x 217 x 128mm	175	360	30	30

Cabeça forjada e temperada em aço carbono especial.
Acabamento com pintura eletrostática na cor preta.
Cabo em madeira envernizada fixado com cunha.

IPI 0% incluso - NCM: 8201.40.00

Forged and hardened carbon steel head.
Black electrostatic painting.
Hardwood handle fixed with steel wedge.

Cabeza forjada en acero carbono y templada.
Pintura electrostática negra.
Mango de madera fijado con cuña metálica.

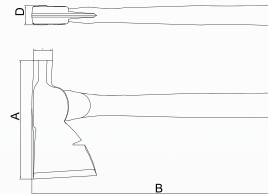

**Produto para
exportação**

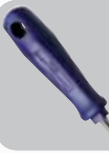

40560 Machadinha com Unha - Basic
Claw Hatchet
Hachita con Uña

REF.	Peso Weight	EAN 789.1114	Embalagem Package Embalaje			Dimensões Dimensions (mm)			
			Un.	KG	Comp x larg x alt Length x width x height Largo x ancho x altura	A	B	C	D
40560/001	450g	00302 4	6	4,58	350 x 175 x 90mm	132	305	84	24,5

Cabeça forjada e temperada em aço carbono especial.
Acabamento jateado envernizado.
Cabo em madeira envernizada fixado com epóxi.

IPI 0% incluso - NCM: 8201.40.00

Forged and hardened carbon steel head.
Sand blasted and varnished head.
Hardwood handle fixed with epoxy.

Cabeza forjada en acero carbono y templada.
Acabado y cabeza barnizada.
Mango de madera fijado con epoxi.

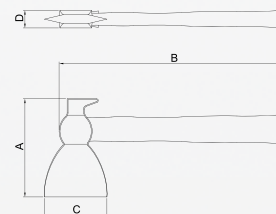



42700

41135

42700 Talhadeira 41135 Stone Chisel Cinzel

REF.	Tamanho Size <i>Tamaño</i>	EAN 789.1114	Embalagem Package <i>Embalaje</i>			Dimensões Dimensions (mm)		
			Un.	KG	Comp x larg x alt Length x width x height <i>Largo x ancho x altura</i>	A	B	C
SUPORTE PLÁSTICO PLASTIC HANGER <i>SOPORTE PLÁSTICO</i>								
42700/108	8"	04815 5	6	2,51	400 x 120 x 65mm	30	200	19,7
42700/110	10"	04816 2	6	3,11	400 x 120 x 65mm	30	250	19,7
42700/112	12"	04817 9	6	3,75	400 x 120 x 65mm	30	300	19,7
42700/114	14"	04818 6	6	4,39	425 x 145 x 95mm	30	350	19,7
42700/116	16"	05540 5	6	5,02	570 x 105 x 80mm	30	400	19,7
SUPORTE PLÁSTICO PLASTIC HANGER <i>SOPORTE PLÁSTICO</i>								
41135/110	10"	06925 9	6	2,99	400 x 120 x 65mm	30	250	18
41135/112	12"	06926 6	6	3,63	400 x 120 x 65mm	30	300	18
41135/114	14"	06927 3	6	4,13	400 x 120 x 65mm	30	350	18

Corpo em aço carbono.
Têmpera por indução nas duas extremidades.
Acabamento fosfatizado.
42700 - corpo sextavado de 3/4".
41135 - corpo redondo de 18mm.

IPI 8% incluso - NCM: 8205.59.00

Carbon steel body.
Induction hardening at the both edges.
Phosphated finishing.
3/4" hexagonal body (42700).
18mm round body (41135).

*Cuerpo en acero carbono.
Temple por inducción en las dos extremidades.
Acabado fosfatado.
Cuerpo hexagonal de 3/4" (42700).
Cuerpo redondo de 18mm (41135).*

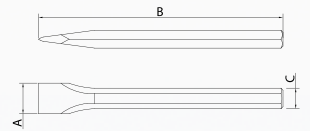

42700 Talhadeira com Empunhadura Stone Chisel with Grip Cinzel con Empuñadura

REF.	Tamanho Size <i>Tamaño</i>	EAN 789.1114	Embalagem Package <i>Embalaje</i>			Dimensões Dimensions (mm)		
			Un.	KG	Comp x larg x alt Length x width x height <i>Largo x ancho x altura</i>	A	B	C
42700/910	10"	08892 2	6	3,24	370 x 198 x 100mm	30	250	80
42700/912	12"	05988 5	6	4,14	370 x 198 x 100mm	30	250	80

Corpo em aço carbono.
Acabamento fosfatizado.
Têmpera por indução nas duas extremidades.
Empunhadura injetada em material resistente e flexível.

IPI 8% incluso - NCM: 8205.59.00

Carbon steel body.
Black electrostatic painting.
Induction hardening at the both edges.
Resistant and flexible injected material grip.

*Cuerpo en acero carbono.
Pintura electrostática negra.
Temple por inducción en las dos extremidades.
Empuñadura inyectada en material resistente y flexible.*

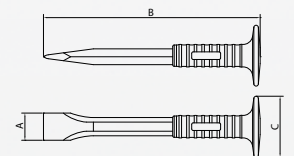

42701 Talhadeira Chata Flat Chisel Cinzel Plano

REF.	Tamanho Size Tamaño	EAN 789.1114	Embalagem Package Embalaje			Dimensões Dimensions (mm)		
			Un.	KG	Comp x larg x alt Length x width x height Largo x ancho x altura	A	B	C
SOPORTE PLÁSTICO PLASTIC HANGER SOPORTE PLÁSTICO 								
42701/108	8"	05534 4	6	2,58	290 x 110 x 75mm	27,5	200	12
42701/110	10"	05535 1	6	3,20	330 x 115 x 70mm	27,5	250	12
42701/112	12"	05536 8	6	3,75	390 x 105 x 80mm	27,5	300	12
42701/114	14"	05537 5	6	4,46	420 x 150 x 100mm	27,5	350	12
42701/116	16"	05538 2	6	5,27	575 x 90 x 80mm	27,5	400	12

Corpo em aço carbono.
Acabamento fosfatizado.
Têmpera por indução nas duas extremidades.

IPI 8% incluso - NCM: 8205.59.00

Carbon steel body.
Black electrostatic painting.
Induction hardening at the both edges.

Cuerpo en acero carbono.
Pintura electrostática negra.
Temple por inducción en las dos extremidades.

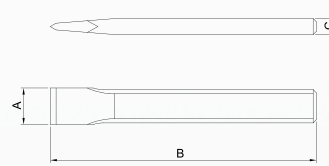

42705 Ponteiro 41136 Stone Pointed Chisel Cinzel de Punta

REF.	Tamanho Size Tamaño	EAN 789.1114	Embalagem Package Embalaje			Dimensões Dimensions (mm)		
			Un.	KG	Comp x larg x alt Length x width x height Largo x ancho x altura	A	B	C
SOPORTE PLÁSTICO PLASTIC HANGER SOPORTE PLÁSTICO 								
42705/108	8"	04819 3	6	2,43	395 x 125 x 65mm	6	200	19,7
42705/110	10"	04820 9	6	3,01	395 x 125 x 65mm	6	250	19,7
42705/112	12"	04821 6	6	3,65	395 x 125 x 65mm	6	300	19,7
42705/114	14"	04822 3	6	4,29	425 x 150 x 95mm	6	350	19,7
42705/116	16"	05542 9	6	4,93	575 x 90 x 80mm	6	400	19,7

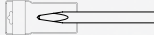
SOPORTE PLÁSTICO PLASTIC HANGER SOPORTE PLÁSTICO 								
41136/110	10"	06928 0	6	2,89	400 x 120 x 65mm	6,5	250	18
41136/112	12"	06929 7	6	3,45	400 x 120 x 65mm	6,5	300	18
41136/114	14"	06930 3	6	4,06	400 x 120 x 65mm	6,5	350	18

Corpo em aço carbono.
Têmpera por indução nas duas extremidades.
Acabamento fosfatizado.
42705 - barra sextavada de 3/4".
41136 - diâmetro de 18mm.

IPI 8% incluso - NCM: 8205.59.00

Carbon steel body.
Induction hardening at the both edges.
Phosphated finishing.
3/4" hexagonal body (42705).
18mm round body (41136).

Cuerpo en acero carbono.
Temple por inducción en las dos extremidades.
Acabado fosfatado.
Cuerpo hexagonal de 3/4" (42705).
Cuerpo redondo de 18mm (41136).

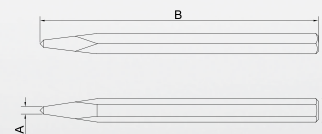

42705

41136

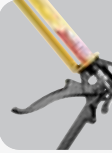
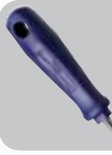



42705 Ponteiro com Empunhadura Stone Pointed Chisel with Grip Cinzel de Punta con Empuñadura

REF.	Tamanho Size <i>Tamaño</i>	EAN 789.1114	Embalagem Package <i>Embalaje</i>			Dimensões Dimensions (mm)		
			Un.	KG	Comp x larg x alt Length x width x height <i>Largo x ancho x altura</i>	A	B	C
42705/910	10"	08894 6	6	3,35	370 x 198 x 100mm	6	250	80
42705/912	12"	08895 3	6	4,14	370 x 198 x 100mm	6	300	80

Corpo em aço carbono.
Acabamento fosfatizado.
Têmpera por indução nas duas extremidades.
Empunhadura injetada em material resistente e flexível.

IPI 8% incluso - NCM: 8205.59.00

Carbon steel body.
Black electrostatic painting.
Induction hardening at the both edges.
Resistant and flexible injected material grip.

Cuerpo en acero carbono.
Pintura electrostática negra.
Temple por inducción en las dos extremidades.
Empuñadura inyectada en material resistente y flexible.

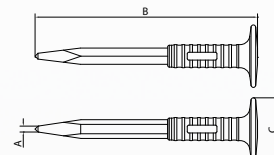

42709 Empunhadura Grip Empuñadura

REF.	Tamanho Size <i>Tamaño</i>	EAN 789.1114	Embalagem Package <i>Embalaje</i>			Dimensões Dimensions (mm)		
			Un.	KG	Comp x larg x alt Length x width x height <i>Largo x ancho x altura</i>	A	B	C
SUPORTE PLÁSTICO PLASTIC HANGER <i>SOPORTE PLÁSTICO</i>								
42709/101	115mm	04823 0	6	0,72	230 x 200 x 105mm	30	115	80
42709/102	155mm	05889 5	6	0,69	230 x 200 x 105mm	30	115	80

Injetada em material resistente e flexível.
42709/001 - utilizada em talhadeiras 42700 e ponteiros 42705.
42709/002 - utilizada em talhadeiras 42701.

IPI 15% incluso - NCM: 3926.90.90

Resistant and flexible injected material.
42709/001 - suitable to be used on chisels 42700 and 42705.
42709/001 - suitable to be used on cutting chisels 42701.

Inyectado en material resistente y flexible.
42709/001 - utilizado en cinceles 42700 y 42705.
42709/002 - utilizado en cinceles 42701.

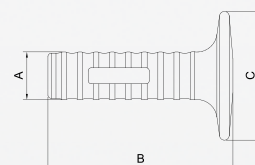

42600 Pé de Cabra Simples
* **Wrecking Bar**
Barreta Sacaclavos Simples

REF.	Tamanho Size Tamaño	EAN 789.1114	Embalagem Package Embalaje			Dimensões Dimensions (mm)				
			Un.	KG	Comp x larg x alt Length x width x height Largo x ancho x altura	A	B	C	D	E
42600/050	500mm	09188 5	1		500 x 120 x 45mm	19,04	21,5	110	500	34
42600/060	600mm	09187 8	1		600 x 120 x 45mm	19,04	21,5	110	600	34

Corpo em aço carbono.
Acabamento com pintura na cor preta.
Têmpera por indução nas extremidades.
42600/050 - tamanho: 20"
42600/060 - tamanho: 24"

IPI 8% incluso - NCM: 8205.59.00

Carbon steel body.
Black painting finishing.
Induction hardening at both edges.
42600/050 - size: 20"
42600/060 - size: 24"

Cuerpo en acero carbono.
Acabado en pintura negra.
Temple por inducción en las extremidades.
42600/050 - tamaño: 20"
42600/060 - tamaño: 24"

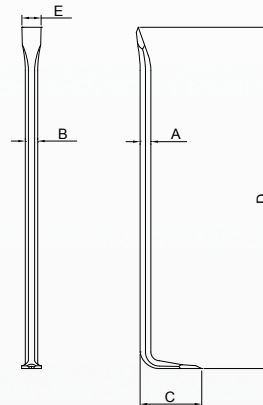

42601 Pé de Cabra Duplo
* **Double Nail Wrecking Bar**
Barreta Sacaclavos Doble

REF.	Tamanho Size Tamaño	EAN 789.1114	Embalagem Package Embalaje			Dimensões Dimensions (mm)				
			Un.	KG	Comp x larg x alt Length x width x height Largo x ancho x altura	A	B	C	D	E
42601/060	600mm	09189 2	1		600 x 165 x 45mm	19,04	21,5	150	600	27
42601/090	900mm	09190 8	1		900 x 165 x 45mm	19,04	21,5	150	900	27

Corpo em aço carbono.
Acabamento com pintura na cor preta.
Têmpera por indução nas extremidades.
42601/060 - tamanho: 24"
42601/090 - tamanho: 36"

IPI 8% incluso - NCM: 8205.59.00

Carbon steel body.
Black painting finishing.
Induction hardening at both edges.
42601/060 - size: 24"
42601/090 - size: 36"

Cuerpo en acero carbono.
Acabado en pintura negra.
Temple por inducción en las extremidades.
42601/060 - tamaño: 24"
42601/090 - tamaño: 36"

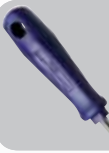
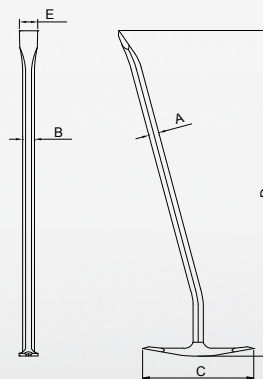

ALICATES E TORQUESES
PLIERS AND PINCERS
PINZAS Y TENAZAS





41001 Alicate Universal Combination Pliers Pinza Universal

REF.	Tamanho Size <i>Tamaño</i>	EAN 789.1114	Embalagem Package <i>Embalaje</i>			Dimensões Dimensions (mm)					
			Un.	KG	Comp x larg x alt Length x width x height <i>Largo x ancho x altura</i>	A	B	C	D	E	
BLISTER CLAM PACK 											
41001/107	7"	00885 2	1	0,28	260 x 75 x 30mm	26	183	54	12	15	
			12	3,52	280 x 190 x 110mm						
41001/108	8"	00886 9	1	0,38	275 x 75 x 30mm	29	203	63,5	13	17,5	
			12	4,68	370 x 195 x 100mm						



Corpo forjado em aço carbono especial e temperado.
Acabamento fosfatizado.
Cabeça e articulação lixadas.
Têmpera especial no gume de corte.
Isolação elétrica de 1.000V C.A.
Produto em conformidade com a NBR 9699 e NR10.

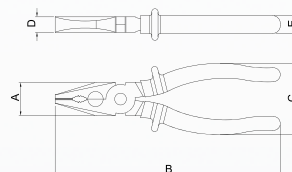

IPI 8% incluso - NCM: 8203.20.10

Forged and hardened carbon steel body.
Phosphated finishing.
Polished head and joint.
Special hardening at the cutting edge.
Electrical insulation up to 1.000V A.C.

*Cuerpo forjado en acero carbono y templado.
Acabado fosfatado.
Cabeza y articulación pulidas.
Temple especial en el hilo de corte.
Aislamiento eléctrico hasta 1.000V C.A.*



41001 Alicate Universal Combination Pliers Pinza Universal

REF.	Tamanho Size <i>Tamaño</i>	EAN 789.1114	Embalagem Package <i>Embalaje</i>			Dimensões Dimensions (mm)					
			Un.	KG	Comp x larg x alt Length x width x height <i>Largo x ancho x altura</i>	A	B	C	D	E	
BLISTER CLAM PACK 											
41001/118	8"	07558 8	1	0,39	275 x 75 x 30mm	29	201	58	13	13	
			12	4,82	370 x 195 x 100mm						



Corpo forjado em aço carbono especial e temperado.
Acabamento fosfatizado.
Cabeça e articulação lixadas.
Têmpera especial no gume de corte.
Isolação elétrica de 1.000V C.A.
Produto em conformidade com a NBR 9699 e NR10.

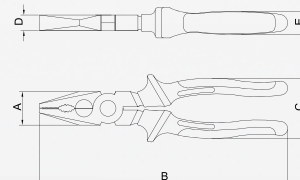

IPI 8% incluso - NCM: 8203.20.10

Forged and hardened carbon steel body.
Phosphated finishing.
Polished head and joint.
Special hardening at the cutting edge.
Electrical insulation up to 1.000V A.C.

*Cuerpo forjado en acero carbono y templado.
Acabado fosfatado.
Cabeza y articulación pulidas.
Temple especial en el hilo de corte.
Aislamiento eléctrico hasta 1.000V C.A.*

41002 Alicate Universal - Basic Combination Pliers - Basic Pinza Universal - Basic

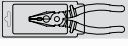
REF.	Tamanho Size Tamaño	EAN 789.1114	Embalagem Package Embalaje			Dimensões Dimensions (mm)				
			Un.	KG	Comp x larg x alt Length x width x height Largo x ancho x altura	A	B	C	D	E
BLISTER CLAM PACK 										
41002/106	6"	08229 6	1	0,17	225 x 65 x 25mm	24,9	160	46,1	8,5	14,5
			12	2,01	320 x 160 x 80mm					
41002/107	7"	06132 1	1	0,20	240 x 65 x 25mm	24,9	180	54	8,5	15
			12	2,51	280 x 170 x 95mm					

Corpo forjado em aço carbono especial e temperado.
Acabamento fosfatado.
Cabeça e articulação lixadas.
Têmpera especial no gume de corte.
Cabos com revestimento especial.

IPI 8% incluso - NCM: 8203.20.10

Forged and hardened carbon steel body.
Phosphated finishing.
Polished head and joint.
Special hardening at the cutting edge.
Handles with special coating.

*Cuerpo forjado en acero carbono y templado.
Acabado fosfatado.
Cabeza y articulación pulidas.
Temple especial en el hilo de corte.
Mangos con revestimiento especial.*

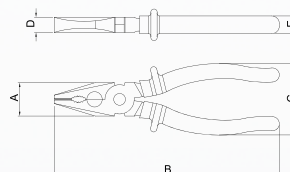

41014 Alicate Universal Electrician's Pliers Pinza Electricista

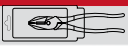
REF.	Tamanho Size Tamaño	EAN 789.1114	Embalagem Package Embalaje			Dimensões Dimensions (mm)				
			Un.	KG	Comp x larg x alt Length x width x height Largo x ancho x altura	A	B	C	D	E
BLISTER CLAM PACK 										
41014/109	9"	05340 1	1	0,48	300 x 75 x 25mm	31,5	235	51	16	16,5
			12	5,90	350 x 175 x 90mm					

Corpo forjado em aço carbono especial e temperado.
Acabamento fosfatado.
Cabeça e articulação lixadas.
Têmpera especial no gume de corte.
Cabos com revestimento especial.

IPI 8% incluso - NCM: 8203.20.10

Forged and hardened carbon steel body.
Phosphated finishing.
Polished head and joint.
Special hardening at the cutting edge.
Handles with special coating.

*Cuerpo forjado en acero carbono y templado.
Acabado fosfatado.
Cabeza y articulación pulidas.
Temple especial en el hilo de corte.
Mangos con revestimiento especial.*

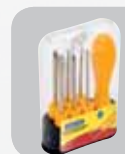
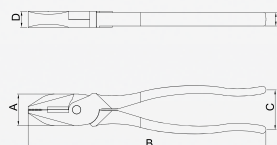



41006 Alicate Corte Diagonal
Diagonal Cutting Pliers
Pinza Corte Diagonal

REF.	Tamanho Size <i>Tamaño</i>	EAN 789.1114	Embalagem Package <i>Embalaje</i>			Dimensões Dimensions (mm)					
			Un.	KG	Comp x larg x alt Length x width x height <i>Largo x ancho x altura</i>	A	B	C	D	E	
BLISTER CLAM PACK											
41006/106	6"	00888 3	1	0,19	240 x 65 x 30mm	18	159	51	11	15,25	
			12	2,50	350 x 175 x 90mm						

Corpo em aço carbono especial forjado e temperado.
Acabamento fosfatado.
Cabeça e articulação lixadas.
Têmpera especial no gume de corte.
Isolação elétrica de 1.000V C.A.
Produto em conformidade com a NBR 9699 e NR10.

IPI 8% incluso - NCM: 8203.20.10



Forged and hardened carbon steel body.
Phosphated finishing.
Polished head and joint.
Special hardening at the cutting edge.
Electrical insulation up to 1.000V A.C.

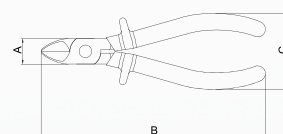

*Cuerpo forjado en acero carbono y templado.
Acabado fosfatado.
Cabeza y articulación pulidas.
Temple especial en el hilo de corte.
Aislamiento eléctrico hasta 1.000V C.A.*



41006 Alicate Corte Diagonal
Diagonal Cutting Pliers
Pinza Corte Diagonal

REF.	Tamanho Size <i>Tamaño</i>	EAN 789.1114	Embalagem Package <i>Embalaje</i>			Dimensões Dimensions (mm)					
			Un.	KG	Comp x larg x alt Length x width x height <i>Largo x ancho x altura</i>	A	B	C	D	E	
BLISTER CLAM PACK											
41006/116	6"	07559 5	1	0,21	240 x 65 x 30mm	18	161	55	11	18	
			12	2,64	350 x 175 x 90mm						

Corpo forjado em aço carbono especial e temperado.
Acabamento fosfatado.
Cabeça e articulação lixadas.
Têmpera especial no gume de corte.
Isolação elétrica de 1.000V C.A.
Produto em conformidade com a NBR 9699 e NR10.

IPI 8% incluso - NCM: 8203.20.10



Forged and hardened carbon steel body.
Phosphated finishing.
Polished head and joint.
Special hardening at the cutting edge.
Electrical insulation up to 1.000V A.C.

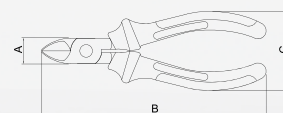

*Cuerpo forjado en acero carbono y templado.
Acabado fosfatado.
Cabeza y articulación pulidas.
Temple especial en el hilo de corte.
Aislamiento eléctrico hasta 1.000V C.A.*

41008 Alicate Bico Meia Cana
Snipe Nose Pliers
Pinza Punta Media Caña

REF.	Tamanho Size <i>Tamaño</i>	EAN 789.1114	Embalagem Package <i>Embalaje</i>			Dimensões Dimensions (mm)				
			Un.	KG	Comp x larg x alt Length x width x height <i>Largo x ancho x altura</i>	A	B	C	D	E
BLISTER CLAM PACK 										
41008/106	6"	00985 9	1	0,17	230 x 65 x 20mm	17	169	54	2,5	14,25
			12	2,07	230 x 200 x 105mm					

Corpo forjado em aço carbono especial e temperado.
Acabamento fosfatizado.
Cabeça e articulação lixadas.
Têmpera especial no gume de corte.
Isolação elétrica de 1.000V C.A.
Produto em conformidade com a NBR 9699 e NR10.

IPI 8% incluso - NCM: 8203.20.10

Forged and hardened carbon steel body.
Phosphated finishing.
Polished head and joint.
Special hardening at the cutting edge.
Electrical insulation up to 1.000V A.C.

*Cuerpo forjado en acero carbono y templado.
Acabado fosfatado.
Cabeza y articulación pulidas.
Temple especial en el hilo de corte.
Aislamiento eléctrico hasta 1.000V C.A.*

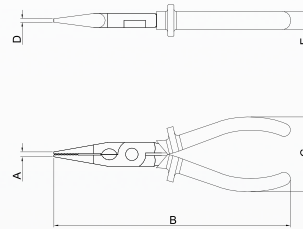

41008 Alicate Bico Meia Cana
Snipe Nose Pliers
Pinza Punta Media Caña

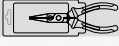
REF.	Tamanho Size <i>Tamaño</i>	EAN 789.1114	Embalagem Package <i>Embalaje</i>			Dimensões Dimensions (mm)				
			Un.	KG	Comp x larg x alt Length x width x height <i>Largo x ancho x altura</i>	A	B	C	D	E
BLISTER CLAM PACK 										
41008/116	6"	07560 1	1	0,18	210 x 70 x 20mm	17	169	55	2,5	18
			12	2,13	230 x 200 x 105mm					

Corpo forjado em aço carbono especial e temperado.
Acabamento fosfatizado.
Cabeça e articulação lixadas.
Têmpera especial no gume de corte.
Isolação elétrica de 1.000V C.A.
Produto em conformidade com a NBR 9699 e NR10.

IPI 8% incluso - NCM: 8203.20.10

Forged and hardened carbon steel body.
Phosphated finishing.
Polished head and joint.
Special hardening at the cutting edge.
Electrical insulation up to 1.000V A.C.

*Cuerpo forjado en acero carbono y templado.
Acabado fosfatado.
Cabeza y articulación pulidas.
Temple especial en el hilo de corte.
Aislamiento eléctrico hasta 1.000V C.A.*

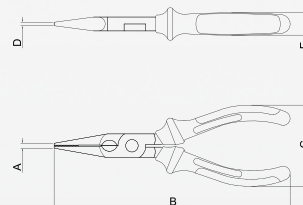



41010 Alicate Bico Chato
Flat Nose Pliers
Pinza Punta Chata

REF.	Tamanho Size <i>Tamaño</i>	EAN 789.1114	Embalagem Package <i>Embalaje</i>			Dimensões Dimensions (mm)					
			Un.	KG	Comp x larg x alt Length x width x height <i>Largo x ancho x altura</i>	A	B	C	D	E	
BLISTER CLAM PACK 											
41010/106	6"	00983 5	1	0,17	220 x 70 x 25mm	17	169	54	2,5	14,25	
			12	2,15	280 x 170 x 95mm						

Corpo forjado em aço carbono especial e temperado.
Acabamento fosfatizado.
Cabeça e articulação lixadas.
Têmpera especial no gume de corte.
Isolação elétrica de 1.000V C.A.
Produto em conformidade com a NBR 9699 e NR10.

IPI 8% incluso - NCM: 8203.20.10



Forged and hardened carbon steel body.
Phosphated finishing.
Polished head and joint.
Special hardening at the cutting edge.
Electrical insulation up to 1.000V A.C.

*Cuerpo forjado en acero carbono y templado.
Acabado fosfatado.
Cabeza y articulación pulidas.
Temple especial en el hilo de corte.
Aislamiento eléctrico hasta 1.000V C.A.*

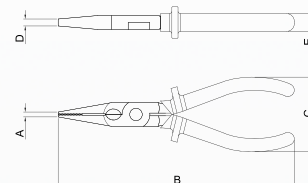

41012 Alicate Corte Frontal
End Cutting Nippers
Pinza Corte Frontal

REF.	Tamanho Size <i>Tamaño</i>	EAN 789.1114	Embalagem Package <i>Embalaje</i>			Dimensões Dimensions (mm)			
			Un.	KG	Comp x larg x alt Length x width x height <i>Largo x ancho x altura</i>	A	B	C	D
BLISTER CLAM PACK 									
41012/114	140mm	05556 6	1	0,20	210 x 50 x 25mm	28,5	140	49	23
			12	2,55	280 x 170 x 95mm				
41012/116	160mm	01614 7	1	0,25	230 x 50 x 30mm	31	160	52	26
			12	2,98	280 x 170 x 95mm				
41012/119	190mm	05422 4	1	0,37	260 x 65 x 40mm	37,5	190	53	30
			12	4,55	330 x 150 x 130mm				
41012/122	220mm	05557 3	1	0,51	320 x 190 x 100mm	41,5	220	53	36
			12	6,13	320 x 190 x 100mm				

Corpo forjado em aço carbono especial e temperado.
Acabamento com pintura eletrostática.
Cabos com revestimento especial.

IPI 8% incluso - NCM: 8203.20.10

Forged and hardened carbon steel body.
Black electrostatic painting.
Hardened jaws.
Handles with special coating.

*Cuerpo forjado en acero carbono y templado.
Pintura electrostática negra.
Mandíbulas templadas.
Mangos con revestimiento especial.*

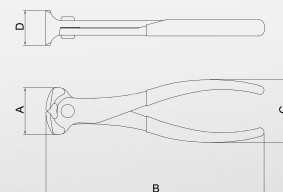

41017 Alicate Corte Frontal End Cutting Nippers Pinza Corte Frontal

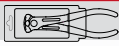
REF.	Tamanho Size <i>Tamaño</i>	EAN 789.1114	Embalagem Package <i>Embalaje</i>			Dimensões Dimensions (mm)			
			Un.	KG	Comp x larg x alt Length x width x height <i>Largo x ancho x altura</i>	A	B	C	D
BLISTER CLAM PACK 									
41017/116	160mm	08720 8	1	0,26	230 x 60 x 30mm	30,5	160	50	24
			12	2,98	280 x 170 x 95mm				
41017/118	180mm	08721 5	1	0,35	260 x 65 x 40mm	39,5	183	55	27
			12	4,55	330 x 150 x 130mm				

Corpo forjado em aço carbono especial e temperado.
Acabamento com pintura eletrostática.
Cabeça polida
Têmpera especial no gume de corte.
Cabos com revestimento especial.

IPI 8% incluso - NCM: 8203.20.10

Forged and hardened carbon steel body.
Black electrostatic painting.
Polished head.
Special hardening at the cutting edge.
Handles with special coating.

*Cuerpo forjado en acero carbono y templado.
Pintura electrostática negra.
Cabeza pulida
Temple especial en el hilo de corte.
Mangos con revestimiento especial.*

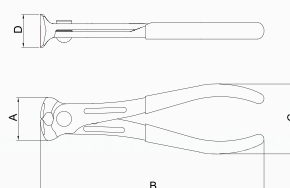

41013 Alicate Fazendeiro * Fence Pliers Pinza para Alambre

REF.	Tamanho Size <i>Tamaño</i>	EAN 789.1114	Embalagem Package <i>Embalaje</i>			Dimensões Dimensions (mm)				
			Un.	KG	Comp x larg x alt Length x width x height <i>Largo x ancho x altura</i>	A	B	C	D	E
BLISTER CLAM PACK 										
41013/110	10"	04934 3	1	0,67	320 x 90 x 30mm	88	275	59	15	18
			6							

Corpo forjado em aço carbono especial e temperado.
Acabamento polido.
Cabos com revestimento especial.

IPI 8% incluso - NCM: 8203.20.10

Forged and hardened carbon steel body.
Polished head.
Handles with special coating.

*Cuerpo forjado en acero carbono y templado.
Cabeza pulida.
Mangos con revestimiento especial.*

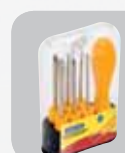
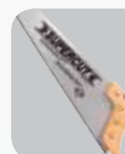
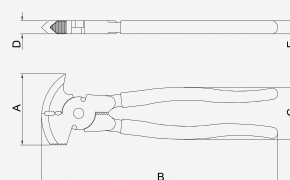

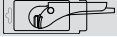

41065 Alicate para Canos
Pipe Wrench
Pinza para Caños

REF.	Tamanho Size Tamaño	EAN 789.1114	Embalagem Package Embalaje			Dimensões Dimensions (mm)					
			Un.	KG	Comp x larg x alt Length x width x height Largo x ancho x altura	A	B	C	D	E	
BLISTER CLAM PACK 											
41065/109	9"	00869 2	1	0,57	280 x 80 x 40mm	57	228	68,5	29	13,5	
			12	6,45	335 x 190 x 145mm						

Mordentes forjados em aço carbono especial e temperados.
Chapas conformadas.
Acabamento com pintura eletrostática.
Abertura ajustável.

IPI 8% incluso - NCM: 8203.20.10

Body with two parts: forged and hardened carbon steel and stamped steel cover.
Black and yellow electrostatic painting.
Adjustable opening.

*Cuerpo en dos partes: chapa estampada y mordiente forjado y templado.
Pintura electrostática amarilla y negra.
Apertura ajustable.*

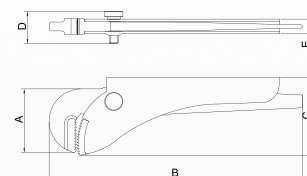

41066 Alicate Bomba d'Água
Water Pump Pliers
Pinza Pico Loro

REF.	Tamanho Size Tamaño	EAN 789.1114	Embalagem Package Embalaje			Dimensões Dimensions (mm)		
			Un.	KG	Comp x larg x alt Length x width x height Largo x ancho x altura	A	B	C
BLISTER CLAM PACK 								
41066/110	10"	00870 8	1	0,42	300 x 80 x 30mm	45,5	138	11,5
			6					

Corpo forjado em aço carbono especial e temperado.
Acabamento fosfatizado.
Cabos com revestimento especial.

IPI 8% incluso - NCM: 8203.20.10

Forged and hardened carbon steel body.
Black electrostatic painting.
Handles with special coating.

*Cuerpo forjado en acero carbono y templado.
Pintura electrostática negra.
Mangos con revestimiento especial.*

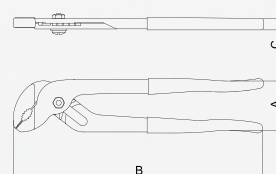

41070 Alicata de Pressão - Mordente triangular
Lock Pliers - Triangular jaw
Pinza de Presión - Mordiente triangular

REF.	Tamanho Size <i>Tamaño</i>	EAN 789.1114	Embalagem Package <i>Embalaje</i>			Dimensões Dimensions (mm)				
			Un.	KG	Comp x larg x alt Length x width x height <i>Largo x ancho x altura</i>	A	B	C	D	E
BLISTER CLAM PACK										
41070/110	10"	06234 2	1	0,60	285 x 80 x 25mm	70	225	57	12	19
			12	7,28	370 x 195 x 100mm					

Mordentes forjados em aço carbono especial e temperados.
Corpo formado por chapas conformadas.
Acabamento cromado.
Abertura regulável.
Possui alavanca para destravar.

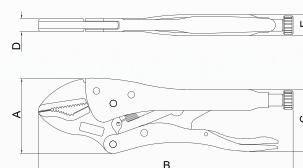

IPI 8% incluso - NCM: 8203.20.10

Forged and hardened carbon steel jaws.
Body formed by conformed metal sheets.
Chrome plated finishing.
Adjustable opening.
Release lever.

Mordientes forjados en acero carbono y templados.
Cuerpo hecho con chapas conformadas.
Acabado cromado.
Apertura ajustable.
Traba de liberación.

41071 Alicata de Pressão - Mordente curvo
Lock Pliers - Curved jaw
Pinza de Presión - Mordiente curvo

REF.	Tamanho Size <i>Tamaño</i>	EAN 789.1114	Embalagem Package <i>Embalaje</i>			Dimensões Dimensions (mm)				
			Un.	KG	Comp x larg x alt Length x width x height <i>Largo x ancho x altura</i>	A	B	C	D	E
BLISTER CLAM PACK										
41071/110	10"	06227 4	1	0,57	285 x 80 x 25mm	70	232	57	12	19
			12	6,99	370 x 195 x 100mm					

Mordentes forjados em aço carbono especial e temperados.
Corpo formado por chapas conformadas.
Acabamento cromado.
Abertura regulável.
Possui alavanca para destravar.

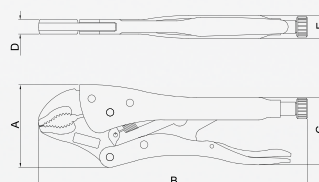

IPI 8% incluso - NCM: 8203.20.10

Forged and hardened carbon steel jaws.
Body formed by conformed metal sheets.
Chrome plated finishing.
Adjustable opening.
Release lever.

Mordientes forjados en acero carbono y templados.
Cuerpo hecho con chapas conformadas.
Acabado cromado.
Apertura ajustable.
Traba de liberación.

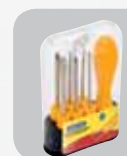
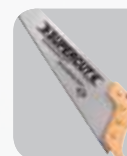



41105 Alicate Bico Meia Cana para Bijuteria - Basic
* Snipe Nose Pliers - Basic
Pinza Punta Media Caña - Basic

REF.	Tamanho Size <i>Tamaño</i>	EAN 789.1114	Embalagem Package <i>Embalaje</i>		Dimensões Dimensions (mm)					
			Un.	KG	Comp x larg x alt Length x width x height <i>Largo x ancho x altura</i>	A	B	C	D	E
BLISTER CLAM PACK										
41105/301	5"	06398 1	12	1,02	210 x 85 x 115mm	15,5	132	52	6,5	8,5
			48	4,27	230 x 190 x 250mm					

Corpo forjado em aço carbono especial e temperado.
Cabeça e articulação lixadas.
Cabos com revestimento especial.

IPI 8% incluso - NCM: 8203.20.10

Forged and hardened carbon steel body.
Ground head and joint.
Special hardening at the cutting edge.
Handles with special coating.

*Cuerpo forjado en acero carbono y templado.
Cabeza y articulación lijadas.
Temple especial en el hilo de corte.
Mangos con revestimiento especial.*

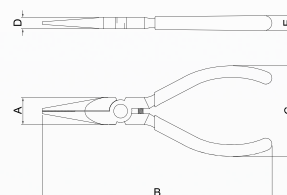

41105 Alicate Corte Diagonal para Bijuteria - Basic
* Diagonal Cutting Pliers - Basic
Pinza Corte Diagonal - Basic

REF.	Tamanho Size <i>Tamaño</i>	EAN 789.1114	Embalagem Package <i>Embalaje</i>		Dimensões Dimensions (mm)					
			Un.	KG	Comp x larg x alt Length x width x height <i>Largo x ancho x altura</i>	A	B	C	D	E
BLISTER CLAM PACK										
41105/302	4"	06399 8	12	0,88	210 x 85 x 115mm	15,5	110	52	6,5	8,5
			48	3,96	230 x 190 x 250mm					

Corpo forjado em aço carbono especial e temperado.
Cabeça e articulação lixadas.
Cabos com revestimento especial.

IPI 8% incluso - NCM: 8203.20.10

Forged and hardened carbon steel body.
Ground head and joint.
Special hardening at the cutting edge.
Handles with special coating.

*Cuerpo forjado en acero carbono y templado.
Cabeza y articulación lijadas.
Temple especial en el hilo de corte.
Mangos con revestimiento especial.*

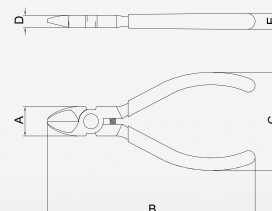

41105 Alicata Bico Redondo para Bijuteria - Basic
* **Round Nose Pliers - Basic**
Pinza Punta Redonda - Basic

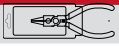
REF.	Tamanho Size <i>Tamaño</i>	EAN 789.1114	Embalagem Package <i>Embalaje</i>		Dimensões Dimensions (mm)					
			Un.	KG	Comp x larg x alt Length x width x height <i>Largo x ancho x altura</i>	A	B	C	D	E
BLISTER CLAM PACK 										
41105/303	5"	06400 1	12	0,96	210 x 85 x 115mm	15,5	123,5	52	6,5	8,5
			48	4,16	230 x 190 x 250mm					

Corpo forjado em aço carbono especial e temperado.
Cabeça e articulação lixadas.
Cabos com revestimento especial.

IPI 8% incluso - NCM: 8203.20.10

Forged and hardened carbon steel body.
Ground head and joint.
Special hardening at the cutting edge.
Handles with special coating.

*Cuerpo forjado en acero carbono y templado.
Cabeza y articulación lijadas.
Temple especial en el hilo de corte.
Mangos con revestimiento especial.*

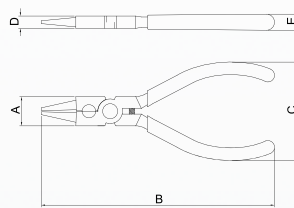

41018 Alicata Corta Cabos
Mini Bolt Cutter
Pinza Corta Cables

REF.	Tamanho Size <i>Tamaño</i>	EAN 789.1114	Embalagem Package <i>Embalaje</i>		Dimensões Dimensions (mm)					
			Un.	KG	Comp x larg x alt Length x width x height <i>Largo x ancho x altura</i>	A	B	C	D	E
BLISTER CLAM PACK 										
41018/108	8"	09406 0	1			33	205	53	15	6,3
			6							

Forjada em aço cromo vanádio
Mola fabricada em aço especial.
Têmpera total no corpo.
Têmpera especial no gume de corte.
Acabamento fosfatado.
Cabos com revestimento especial.
Capacidade de corte: fios com diâmetro máximo de 5mm.

IPI 8% incluso - NCM: 8203.20.10

Forged chrome vanadium steel.
Spring made in special steel.
Full hardening at the body.
Special hardening at the cutting edge.
Phosphated finish.
Handles with special coating.
Cutting capacity: wires up to 5mm of diameter.



*Cuerpo forjado en acero carbono y templado.
Resorte fabricado en acero especial.
Temple total en el cuerpo.
Temple especial en el hilo de corte.
Acabado fosfatado.
Mangos con revestimiento especial.
Capacidad de corte: cables con diámetro máximo de 5mm.*

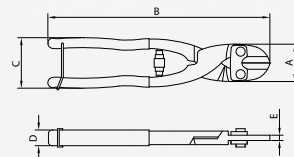



41050 Torquês Carpinteiro Carpenter's Pincers Tenaza Carpintero

REF.	Tamanho Size Tamaño	EAN 789.1114	Embalagem Package Embalaje			Dimensões Dimensions (mm)					
			Un.	KG	Comp x larg x alt Length x width x height Largo x ancho x altura	A	B	C	D	E	
BLISTER CLAM PACK 											
41050/106	6"	00873 9	1	0,20	205 x 50 x 20mm	32	152	45	16	9	
			12	2,59	320 x 160 x 80mm						
41050/108	8"	00874 6	1	0,38	255 x 55 x 20mm	40	204	45	20	12	
			12	4,67	350 x 175 x 90mm						
41050/110	10"	01688 8	1	0,46	305 x 55 x 25mm	50	254	50	20	12	
			12	5,57	350 x 175 x 90mm						

Corpo forjado em aço carbono especial e temperado.
Acabamento com pintura eletrostática na cor preta.

IPI 8% incluso - NCM: 8203.20.90

Forged and hardened carbon steel body.
Black electrostatic painting.

Cuerpo forjado en acero carbono y templado.
Pintura electrostática negra.

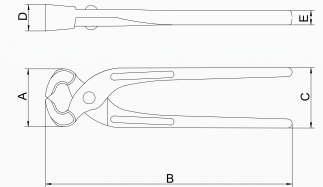

41051 Torquês Armador Concretor's Pincers Tenaza para Armar

REF.	Tamanho Size Tamaño	EAN 789.1114	Embalagem Package Embalaje			Dimensões Dimensions (mm)					
			Un.	KG	Comp x larg x alt Length x width x height Largo x ancho x altura	A	B	C	D	E	
BLISTER CLAM PACK 											
41051/120	200mm	01744 1	1	0,24	255 x 50 x 20mm	29	190	45	17	11	
			12	3,05	350 x 175 x 90mm						
41051/122	220mm	01745 8	1	0,35	275 x 50 x 20mm	32	217	45	19	13	
			12	4,31	350 x 175 x 90mm						
41051/125	250mm	01746 5	1	0,44	310 x 55 x 20mm	37	248	45	21	13	
			12	5,40	370 x 195 x 100mm						
41051/128	280mm	01747 2	1	0,49	335 x 210 x 115mm	38	277	45	23	13	
			12	6,15	335 x 210 x 115mm						
41051/130	300mm	05559 7	1	0,58	370 x 195 x 100mm	40	295	45	25	13	
			12	7,03	370 x 195 x 100mm						

Corpo forjado em aço carbono especial e temperado.
Cabeça polida. Têmpera especial no gume de corte.
Acabamento com pintura eletrostática na cor preta.
Cabos com revestimento especial.

IPI 8% incluso - NCM: 8203.20.90

Forged and hardened carbon steel body.
Polished head. Special hardening at the cutting edge.
Black electrostatic painting.
Handles with special coating.

Cuerpo forjado en acero carbono y templado.
Cabeza polida. Temple especial en el hilo de corte.
Pintura electrostática negra.
Mangos con revestimiento especial.

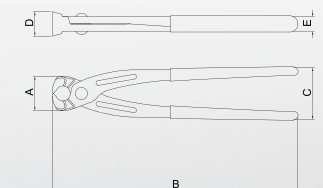

41053 Torquês de Armador Tower Pincers Tenaza para Armar

REF.	Tamanho Size Tamaño	EAN 789.1114	Embalagem Package Embalaje			Dimensões Dimensions (mm)				
			Un.	KG	Comp x larg x alt Length x width x height Largo x ancho x altura	A	B	C	D	E
BLISTER CLAM PACK 										
41053/110	10"	008753	1	0,46	300 x 60 x 30mm	43,5	254	52	20	12,5
			12	5,62	350 x 175 x 90mm					
41053/112	12"	00876 0	1	0,55	365 x 60 x 30mm	43,5	305	53	22	12,5
			12	6,81	370 x 195 x 100mm					
41053/113	13"	00877 7	1	0,61	390 x 65 x 30mm	43,5	328,5	55	23	12,5
			12	7,43	430 x 150 x 95mm					

Corpo forjado em aço carbono especial e temperado.
Acabamento com pintura eletrostática na cor preta.

IPI 8% incluso - NCM: 8203.20.90

Forged and hardened carbon steel body.
Black electrostatic painting.

*Cuerpo forjado en acero carbono y templado.
Pintura electrostática negra.*

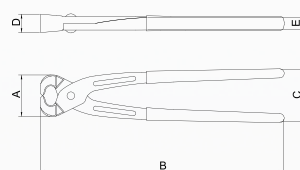

41054 Torquês de Armador - Meio Corte Tower Pincers - Half cutting Tenaza para Armar - Medio corte

REF.	Tamanho Size Tamaño	EAN 789.1114	Embalagem Package Embalaje			Dimensões Dimensions (mm)				
			Un.	KG	Comp x larg x alt Length x width x height Largo x ancho x altura	A	B	C	D	E
BLISTER CLAM PACK 										
41054/110	10"	00878 4	1	0,46	300 x 55 x 25mm	43,5	254	52	20	12,5
			12	5,68	350 x 175 x 90mm					
41054/112	12"	00879 1	1	0,54	360 x 55 x 25mm	43,5	305	53	22	12,5
			12	6,62	370 x 195 x 100mm					

Corpo forjado em aço carbono especial e temperado.
Acabamento com pintura eletrostática na cor preta.

IPI 8% incluso - NCM: 8203.20.90

Forged and hardened carbon steel body.
Black electrostatic painting.

*Cuerpo forjado en acero carbono y templado.
Pintura electrostática negra.*

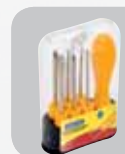
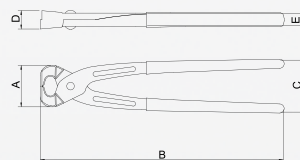

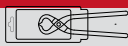

41055 Torquês de Azulejista Tile Pincers Tenaza para Azulejos

REF.	Tamanho Size Tamaño	EAN 789.1114	Embalagem Package Embalaje			Dimensões Dimensions (mm)				
			Un.	KG	Comp x larg x alt Length x width x height Largo x ancho x altura	A	B	C	D	E
BLISTER CLAM PACK 										
41055/106	6"	00880 7	1	0,14	160 x 50 x 15mm	38	158	44	8	8,5
			12	1,80	320 x 160 x 80mm					

Corpo estampado em aço carbono especial e temperado.
Acabamento com pintura eletrostática na cor preta.

IPI 8% incluso - NCM: 8203.20.90

Stamped and hardened carbon steel body.
Black electrostatic painting.

Cuerpo estampado en acero carbono y templado.
Pintura electrostática negra.

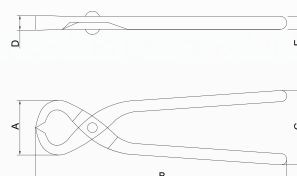

41057 Torquês Carpinteiro Carpenter's Pincers Tenaza Carpintero

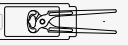
REF.	Tamanho Size Tamaño	EAN 789.1114	Embalagem Package Embalaje			Dimensões Dimensions (mm)				
			Un.	KG	Comp x larg x alt Length x width x height Largo x ancho x altura	A	B	C	D	E
BLISTER CLAM PACK 										
41057/116	160mm	44908 2	12	3,68	320 x 160 x 80mm	48	160	45	23	13
41057/118	180mm	06667 8	12	3,90	280 x 170 x 95mm	48	180	45	24	13
41057/120	200mm	06668 5	12	5,40	350 x 175 x 90mm	55	200	45	25	14,4

Corpo forjado em aço carbono especial e temperado.
Cabeça polida.
Acabamento com pintura eletrostática na cor preta.

IPI 8% incluso - NCM: 8203.20.10

Forged and hardened carbon steel body.
Polished head.
Black electrostatic painting.

Cuerpo forjado en acero carbono y templado.
Cabeza pulida.
Pintura electrostática negra.

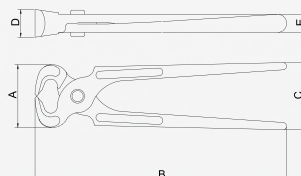

**Produto para
exportação**

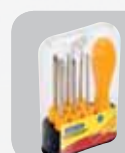
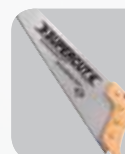

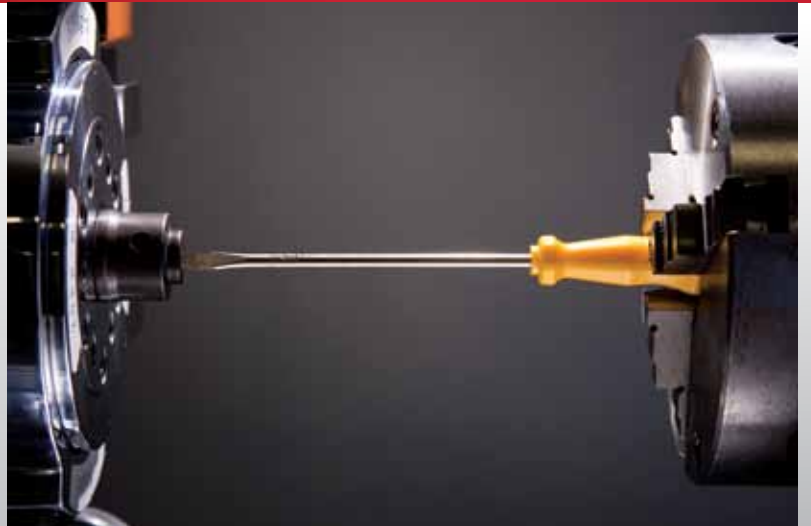

CHAVES DE FENDA
SCREWDRIVERS
DESTORNILLADORES





41400 Chave de Fenda - Quadrum - Ponta Chata
Screwdriver - Quadrum - Slotted tip
Destornilladores - Quadrum - Punta chata

REF.	Tamanho Size <i>Tamaño</i>	EAN 789.1114	Embalagem Package <i>Embalaje</i>			Dimensões Dimensions (mm)				
			Un.	KG	Comp x larg x alt Length x width x height <i>Largo x ancho x altura</i>	A	B	C	D	E
41400/010	3x75mm (1/8x3")	00721 3	12	0,26	195 x 80 x 50mm	3	150	18,9	75	0,8
41400/011	3x100mm (1/8x4")	00722 0	12	0,30	220 x 90 x 65mm	3	175	18,9	100	0,8
41400/012	3x125mm (1/8x5")	00723 7	12	0,32	220 x 90 x 65mm	3	200	18,9	125	0,8
41400/013	3x150mm (1/8x6")	00724 4	12	0,34	275 x 95 x 60mm	3	225	18,9	150	0,8
41400/020	5x75mm (3/16x3")	00725 1	12	0,52	220 x 90 x 65mm	5,5	170	22,7	80	1,3
41400/021	5x100mm (3/16x4")	00726 8	12	0,56	220 x 90 x 65mm	5,5	190	22,7	100	1,3
41400/022	5x125mm (3/16x5")	00727 5	12	0,61	280 x 95 x 60mm	5,5	220	22,7	125	1,3
41400/023	5x150mm (3/16x6")	00728 2	12	0,66	275 x 95 x 60mm	5,5	245	22,7	155	1,3
41400/030	6x100mm (1/4x4")	00729 9	12	0,79	275 x 95 x 60mm	6,7	205	26	100	1,35
41400/031	6x125mm (1/4x5")	00730 5	12	0,88	280 x 110 x 70mm	6,7	230	26	130	1,35
41400/032	6x150mm (1/4x6")	00731 2	12	0,96	280 x 110 x 70mm	6,7	255	26	150	1,35
41400/033	6x200mm (1/4x8")	00732 9	12	1,12	390 x 110 x 80mm	6,7	305	26	200	1,35
41400/034	6x250mm (1/4x10")	00733 6	12	1,25	390 x 110 x 80mm	6,7	355	26	250	1,35
41400/040	8x100mm (5/16x4")	00734 3	6	0,66	285 x 95 x 46mm	8,2	215	28,3	100	1,4
41400/041	8x125mm (5/16x5")	00735 0	6	0,71	445 x 100 x 50mm	8,2	240	28,3	125	1,4
41400/042	8x150mm (5/16x6")	00736 7	6	0,74	285 x 95 x 46mm	8,2	265	28,3	150	1,4
41400/043	8x200mm (5/16x8")	00737 4	6	0,86	385 x 95 x 46mm	8,2	315	28,3	200	1,4
41400/044	8x250mm (5/16x10")	00738 1	6	0,99	385 x 95 x 46mm	8,2	365	28,3	250	1,4
41400/045	8x300mm (5/16x12")	02163 9	6	1,115	385 x 95 x 46mm	8,2	415	28,3	300	1,4
41400/050	9x150mm (3/8x6")	00739 8	6	0,83	285 x 95 x 46mm	10,3	265	28,3	150	1,5
41400/051	9x200mm (3/8x8")	00740 4	6	0,99	385 x 95 x 46mm	10,3	315	28,3	200	1,5
41400/052	9x250mm (3/8x10")	00741 1	6	1,16	385 x 95 x 46mm	10,3	365	28,3	250	1,5
41400/053	9x300mm (3/8x12")	02164 6	6	1,32	385 x 95 x 46mm	10,3	415	28,3	300	1,5

Haste em aço carbono temperado.
Acabamento niquelado.
Cabo injetado.

IPI 8% incluso - NCM: 8205.40.00

Hardened carbon steel blade.
Nickel plated finishing.
Injected handle.

*Asta en acero carbono templado.
Acabado niquelado.
Mango inyectado.*

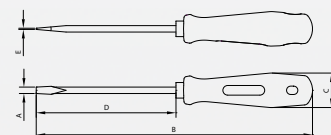

41402 Chave de Fenda Toco - Quadrum - Ponta Chata
Stubby Type Screwdriver - Quadrum - Slotted tip
Destornillador Corto - Quadrum - Punta chata

REF.	Tamanho Size <i>Tamaño</i>	EAN 789.1114	Embalagem Package <i>Embalaje</i>			Dimensões Dimensions (mm)				
			Un.	KG	Comp x larg x alt Length x width x height <i>Largo x ancho x altura</i>	A	B	C	D	E
41402/001	5x38mm (3/16x1.1/2")	01082 4	12	0,41	220 x 90 x 65mm	5	115	25,5	50	1,3
41402/002	6x38mm (1/4x1.1/2")	01083 1	12	0,47	220 x 90 x 65mm	6,6	110	25,5	45	1,3

Haste em aço carbono temperado.
Acabamento niquelado.
Cabo injetado.

IPI 8% incluso - NCM: 8205.40.00

Hardened carbon steel blade.
Nickel plated finishing.
Injected handle.

Asta en acero carbono templado.
Acabado niquelado.
Mango inyectado.

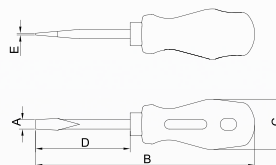

41405 Chave de Fenda - Quadrum - Ponta Cruzada
Screwdriver - Quadrum - Cross recessed tip
Destornillador - Quadrum - Punta cruzada

REF.	Tamanho Size <i>Tamaño</i>	EAN 789.1114	Embalagem Package <i>Embalaje</i>			Dimensões Dimensions (mm)				
			Un.	KG	Comp x larg x alt Length x width x height <i>Largo x ancho x altura</i>	A	B	C	D	E
41405/010	3x75mm (1/8x3")	00743 5	12	0,27	195 x 80 x 50mm	3	155	18,9	75	1,5
41405/011	3x125mm (1/8x5")	02165 3	12	0,33	280 x 95 x 60mm	3	200	18,9	125	1,5
41405/020	5x75mm (3/16x3")	00744 2	12	0,52	220 x 90 x 65mm	5	170	22,7	75	1,5
41405/021	5x100mm (3/16x4")	00745 9	12	0,57	220 x 90 x 65mm	5	195	22,7	100	2
41405/022	5x150mm (3/16x6")	02166 0	12	0,61	280 x 95 x 60mm	5	245	22,7	150	2
41405/030	6x100mm (1/4x4")	00746 6	12	0,79	280 x 95 x 60mm	6	205	26	100	3
41405/031	6x150mm (1/4x6")	00747 3	12	0,96	280 x 110 x 70mm	6	255	26	155	3
41405/032	6x200mm (1/4x8")	02167 7	12	1,11	390 x 110 x 80mm	6	305	26	200	3
41405/040	8x150mm (5/16x6")	00748 0	6	0,74	285 x 95 x 46mm	8	265	28,3	150	4,5
41405/050	10x200mm (3/8x8")	00749 7	6	1,15	385 x 95 x 46mm	10	315	28,3	200	5,5

Haste em aço carbono temperado.
Acabamento niquelado.
Cabo injetado.

IPI 8% incluso - NCM: 8205.40.00

Hardened carbon steel blade.
Nickel plated finishing.
Injected handle.

Asta en acero carbono templado.
Acabado niquelado.
Mango inyectado.

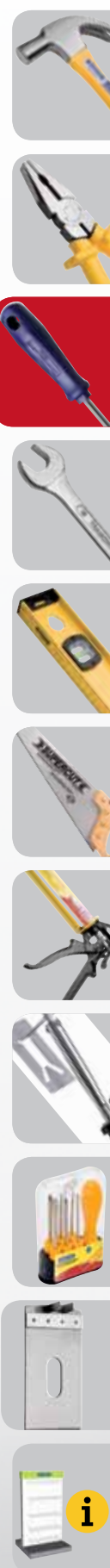
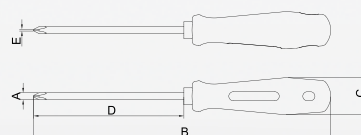



41407 Chave de Fenda Toco - Quadrum - Ponta cruzada
Stubby Type Screwdriver - Quadrum - Cross recessed tip
Destornillador Corto - Quadrum - Punta cruzada

REF.	Tamanho Size <i>Tamaño</i>	EAN 789.1114	Embalagem Package <i>Embalaje</i>			Dimensões Dimensions (mm)				
			Un.	KG	Comp x larg x alt Length x width x height <i>Largo x ancho x altura</i>	A	B	C	D	E
41407/001	5x38mm (3/16x1.1/2")	01210 1	12	0,41	220 x 90 x 65mm	5	105	25,5	40	2
41407/002	6x38mm (1/4x1.1/2")	01211 8	12	0,47	220 x 90 x 65mm	6	115	25,5	50	3

Haste em aço carbono temperado.
Acabamento niquelado.
Cabo injetado.

IPI 8% incluso - NCM: 8205.40.00

Hardened carbon steel blade.
Nickel plated finishing.
Injected handle.

*Asta en acero carbono templado.
Acabado niquelado.
Mango inyectado.*

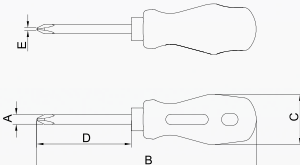

41415 Jogo de Chaves de Fenda - Quadrum
Screwdriver Set - Quadrum
Juego de Destornillador - Quadrum

REF.	Peças Pieces <i>Piezas</i>	EAN 789.1114	Embalagem Package <i>Embalaje</i>		
			Un.	KG	Comp x larg x alt Length x width x height <i>Largo x ancho x altura</i>
41415/006	6	04530 7	6	2,59	340 x 310 x 130mm

Composição:

- 3 Chaves de fenda ponta chata 1/8x3", 1/4x5" e 1/4x6";
- 3 Chaves de fenda ponta cruzada 1/8x3", 1/4x4" e 1/4x6";
- Embalagem em berço plástico e cartucho litografado.

Set includes:

- 3 Slotted tip screwdrivers: 1/8x3", 1/4x5" and 1/4x6".
- 3 Cross recessed tip screwdrivers: 1/8x3", 1/4x4" and 1/4x6".
- Package: held in plastic insert within printed box.

Composición:

- 3 Destornilladores punta chata: 1/8x3", 1/4x5" y 1/4x6".
- 3 Destornilladores punta cruzada: 1/8x3", 1/4x4" y 1/4x6".
- Embalaje: bandeja plástica modular en embalaje litografiada.

IPI 8% incluso - NCM: 8205.40.00



41415 Jogo de Chaves de Fenda - Quadrum
Screwdriver Set - Quadrum
Juego de Destornillador - Quadrum

REF.	Peças Pieces <i>Piezas</i>	EAN 789.1114	Embalagem Package <i>Embalaje</i>		
			Un.	KG	Comp x larg x alt Length x width x height <i>Largo x ancho x altura</i>
41415/505	5	06068 3	6	1,49	340 x 310 x 130mm

Composição:

- 3 Chaves de fenda ponta chata 1/8x3", 3/16x4" e 1/4x5";
- 2 Chaves de fenda ponta cruzada 1/8x3" e 3/16x4";
- Embalagem blister.

Set includes:

- 3 Slotted tip screwdrivers: 1/8x3", 3/16x4" and 1/4x5".
- 2 Cross recessed tip screwdrivers: 1/8x3" and 3/16x4".
- Clam pack.

Composición:

- 3 Destornilladores punta chata: 1/8x3", 3/16x4" y 1/4x5".
- 2 Destornilladores punta cruzada: 1/8x3" y 3/16x4".
- Embalaje clam pack.

IPI 8% incluso - NCM: 8205.40.00

41450 Chave Canhão Tubular Tubular Nut Drivers Destornilladores de Tuerca Tubular



REF.	Tamanho Size <i>Tamaño</i>	EAN 789.1114	Embalagem Package <i>Embalaje</i>			Dimensões Dimensions (mm)					
			Un.	KG	Comp x larg x alt Length x width x height <i>Largo x ancho x altura</i>	A	B	C	D	E	F
41450/006	6mm	09026 0	6	0,18	260 x 90 x 55mm	225	25,7	125	9,40	7,94	4,94
41450/007	7mm	09027 7	6	0,18	260 x 90 x 55mm	225	25,7	125	11,0	9,52	6,52
41450/008	8mm	09028 4	6	0,18	260 x 90 x 55mm	225	25,7	125	12,2	10,0	7,0
41450/009	9mm	09029 1	6	0,18	260 x 90 x 55mm	225	25,7	125	13,5	10,0	7,0
41450/010	10mm	09030 7	6	0,18	260 x 90 x 55mm	225	28,6	125	14,7	12,7	9,7
41450/011	11mm	09031 4	6	0,18	260 x 90 x 55mm	236	28,6	125	16,0	12,7	9,7
41450/012	12mm	09032 1	6	0,18	260 x 90 x 55mm	236	28,6	125	17,2	12,7	9,7

Haste em aço carbono temperado.
Acabamento cromado.
Cabo injetado.

IPI 8% incluso - NCM: 8205.40.00

Hardened carbon steel blade.
Chrome plated finishing.
Injected handle.

*Asta en acero carbono templado.
Acabado cromado.
Mango inyectado.*

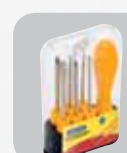
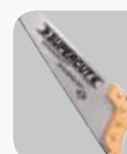
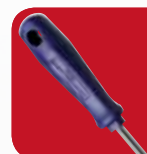
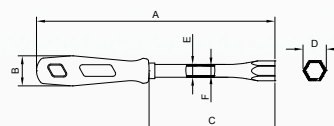



41500 Chave de Fenda - Yellow - Ponta Chata
Screwdriver - Yellow - Slotted tip
Destornilladores - Yellow - Punta chata

REF.	Tamanho Size Tamaño	EAN 789.1114	Embalagem Package Embalaje			Dimensões Dimensions (mm)				
			Un.	KG	Comp x larg x alt Length x width x height Largo x ancho x altura	A	B	C	D	E
41500/010	3x75mm (1/8x3")	01084 8	12	0,31	190 x 95 x 65mm	3,2	155	23	75	0,8
41500/011	3x100mm (1/8x4")	01085 5	12	0,32	220 x 5 x 65mm	3,2	185	23	100	0,8
41500/012	3x125mm (1/8x5")	01086 2	12	0,34	275 x 95 x 65mm	3,2	210	23	125	0,8
41500/013	3x150mm (1/8x6")	01087 9	12	0,36	275 x 95 x 65mm	3,2	235	23	155	0,8
41500/020	5x75mm (3/16x3")	01088 6	12	0,51	220 x 95 x 65mm	5,5	170	25,7	75	1,3
41500/021	5x100mm (3/16x4")	01089 3	12	0,55	220 x 95 x 65mm	5,5	195	25,7	100	1,3
41500/022	5x125mm (3/16x5")	01090 9	12	0,60	275 x 95 x 65mm	5,5	215	25,7	125	1,3
41500/023	5x150mm (3/16x6")	01091 6	12	0,64	275 x 95 x 65mm	5,5	245	25,7	150	1,3
41500/030	6x100mm (1/4x4")	01092 3	12	0,75	275 x 95 x 65mm	6,7	200	28,5	100	1,35
41500/031	6x125mm (1/4x5")	01093 0	12	0,81	285 x 110 x 75mm	6,7	225	28,5	125	1,35
41500/032	6x150mm (1/4x6")	01094 7	12	0,91	285 x 110 x 75mm	6,7	255	28,5	150	1,35
41500/033	6x200mm (1/4x8")	01095 4	12	1,08	390 x 110 x 80mm	6,7	300	28,5	200	1,35
41500/034	6x250mm (1/4x10")	01096 1	12	1,21	390 x 110 x 80mm	6,7	355	28,5	250	1,35
41500/040	8x100mm (5/16x4")	01097 8	6	0,67	248 x 100 x 58mm	8,2	215	30,5	100	1,4
41500/041	8x125mm (5/16x5")	01098 5	6	0,68	285 x 95 x 46mm	8,2	240	30,5	125	1,4
41500/042	8x150mm (5/16x6")	01099 2	6	0,72	290 x 97 x 60mm	8,2	265	30,5	150	1,4
41500/043	8x200mm (5/16x8")	01100 5	6	0,84	385 x 95 x 46mm	8,2	315	30,5	200	1,4
41500/044	8x250mm (5/16x10")	01101 2	6	0,97	445 x 100 x 50mm	8,2	365	30,5	250	1,4
41500/045	8x300mm (5/16x12")	01394 8	6	1,10	445 x 100 x 50mm	8,2	415	30,5	300	1,4
41500/050	9x150mm (3/8x6")	01102 9	6	0,84	445 x 100 x 50mm	10,3	275	31,5	150	1,5
41500/051	9x200mm (3/8x8")	01103 6	6	1,00	385 x 95 x 46mm	10,3	320	31,5	200	1,5
41500/052	9x250mm (3/8x10")	01104 3	6	1,15	385 x 95 x 46mm	10,3	370	31,5	250	1,5
41500/053	9x300mm (3/8x12")	01395 5	6	1,31	445 x 100 x 50mm	10,3	420	31,5	300	1,5

Haste em aço carbono temperado.
Acabamento niquelado.
Cabo injetado.

IPI 8% incluso - NCM: 8205.40.00

Hardened carbon steel blade.
Nickel plated finishing.
Injected handle.

*Asta en acero carbono templado.
Acabado niquelado.
Mango inyectado.*

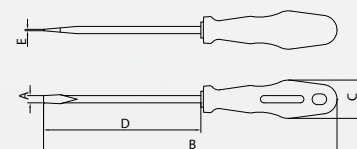

41501 Chave de Fenda Clipe - Yellow - Ponta Chata
Pocket Screwdriver - Yellow - Slotted tip
Destornillador Clip - Yellow - Punta chata

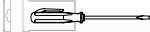
REF.	Tamanho Size <i>Tamaño</i>	EAN 789.1114	Embalagem Package <i>Embalaje</i>			Dimensões Dimensions (mm)				
			Un.	KG	Comp x larg x alt Length x width x height <i>Largo x ancho x altura</i>	A	B	C	D	E
SOPORTE PLÁSTICO PLASTIC HANGER <i>SOPORTE PLÁSTICO</i>										
41501/100	3x75mm (1/8x3")	03942 9	12	0,25	280 x 110 x 70mm	3,2	135	16	75	0,8

Haste em aço carbono temperado.
Acabamento niquelado.
Cabo injetado.

IPI 8% incluso - NCM: 8205.40.00

Hardened carbon steel blade.
Nickel plated finishing.
Injected handle.

Asta en acero carbono templado.
Acabado niquelado.
Mango inyectado.

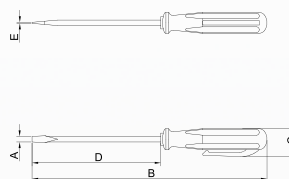

41502 Chave de Fenda Toco - Yellow - Ponta Chata
Stubby Type Screwdriver - Yellow - Slotted tip
Destornillador Corto - Yellow - Punta chata

REF.	Tamanho Size <i>Tamaño</i>	EAN 789.1114	Embalagem Package <i>Embalaje</i>			Dimensões Dimensions (mm)				
			Un.	KG	Comp x larg x alt Length x width x height <i>Largo x ancho x altura</i>	A	B	C	D	E
41502/001	5x38mm (3/16x1.1/2")	01376 4	12	0,35	210 x 115 x 35mm	5	95	28	40	1,3
41502/002	6x38mm (1/4x1.1/2")	01377 1	12	0,41	210 x 115 x 35mm	6	95	28	40	1,5

Haste em aço carbono temperado.
Acabamento niquelado.
Cabo injetado.

IPI 8% incluso - NCM: 8205.40.00

Hardened carbon steel blade.
Nickel plated finishing.
Injected handle.

Asta en acero carbono templado.
Acabado niquelado.
Mango inyectado.

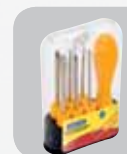
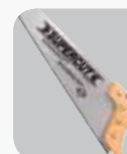
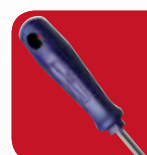
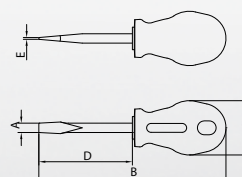



41505 Chave de Fenda - Yellow - Ponta cruzada
Screwdriver - Yellow - Cross recessed tip
Destornillador - Yellow - Punta cruzada

REF.	Tamanho Size <i>Tamaño</i>	EAN 789.1114	Embalagem Package <i>Embalaje</i>			Dimensões Dimensions (mm)				
			Un.	KG	Comp x larg x alt Length x width x height <i>Largo x ancho x altura</i>	A	B	C	D	E
41505/010	3x75mm (1/8x3")	01105 0	12	0,32	220 x 95 x 65mm	3	150	23	70	0,8
41505/011	3x125mm (1/8x5")	01396 2	12	0,34	275 x 95 x 60mm	3	210	23	125	0,8
41505/020	5x75mm (3/16x3")	01106 7	12	0,51	220 x 95 x 65mm	5	165	25,7	70	2
41505/021	5x100mm (3/16x4")	01107 4	12	0,56	220 x 95 x 65mm	5	195	25,7	100	2
41505/022	5x150mm (3/16x6")	01397 9	12	0,65	275 x 95 x 60mm	5	245	25,7	150	2
41505/030	6x100mm (1/4x4")	01108 1	12	0,75	275 x 95 x 60mm	6	205	28,5	100	3
41505/031	6x150mm (1/4x6")	01109 8	12	0,90	280 x 110 x 70mm	6	250	28,5	150	3
41505/032	6x200mm (1/4x8")	01398 6	12	1,06	390 x 110 x 80mm	6	300	28,5	200	3
41505/040	8x150mm (5/16x6")	01110 4	6	0,73	290 x 97 x 60mm	8	265	30,5	150	4,5
41505/050	10x200mm (3/8x8")	01111 1	6	1,15	445 x 100 x 50mm	10	315	30,5	200	5,5

Haste em aço carbono temperado.
Acabamento niquelado.
Cabo injetado.

IPI 8% incluso - NCM: 8205.40.00

Hardened carbon steel blade.
Nickel plated finishing.
Injected handle.

Asta en acero carbono templado.
Acabado niquelado.
Mango inyectado.

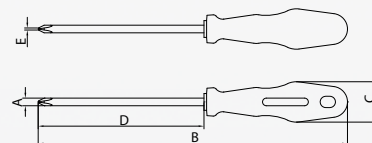

41507 Chave de Fenda Toco - Yellow - Ponta cruzada
Stubby Type Screwdriver - Yellow - Cross recessed tip
Destornillador Corto - Yellow - Punta cruzada

REF.	Tamanho Size <i>Tamaño</i>	EAN 789.1114	Embalagem Package <i>Embalaje</i>			Dimensões Dimensions (mm)				
			Un.	KG	Comp x larg x alt Length x width x height <i>Largo x ancho x altura</i>	A	B	C	D	E
41507/001	5x38mm (3/16x1.1/2")	01378 8	12	0,36	210 x 115 x 35mm	5	95	28	40	2
41507/002	6x38mm (1/4x1.1/2")	01379 5	12	0,41	210 x 115 x 35mm	6	95	28	40	3

Haste em aço carbono temperado.
Acabamento niquelado.
Cabo injetado.

IPI 8% incluso - NCM: 8205.40.00

Hardened carbon steel blade.
Nickel plated finishing.
Injected handle.

Asta en acero carbono templado.
Acabado niquelado.
Mango inyectado.

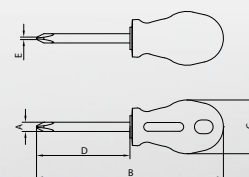

41508 Chave de Fenda para Eletrônica - Yellow - Ponta Chata
Electronic Screwdriver - Yellow - Slotted tip
Destornillador para Eletrônica - Yellow - Punta chata



REF.	Tamanho Size <i>Tamaño</i>	EAN 789.1114	Embalagem Package <i>Embalaje</i>		Dimensões Dimensions (mm)					
			Un.	KG	Comp x larg x alt Length x width x height <i>Largo x ancho x altura</i>	A	B	C	D	E
41508/013	3x150mm (1/8x6")	01112 8	12	0,37	275 x 95 x 60mm	3	230	23	155	0,8
41508/014	3x200mm (1/8x8")	01113 5	12	0,46	390 x 110 x 80mm	3	280	23	205	0,8
41508/015	3x250mm (1/8x10")	01114 2	12	0,51	390 x 110 x 80mm	3	325	23	250	0,8

Haste em aço carbono temperado.
Acabamento niquelado.
Cabo injetado.
Isolação elétrica de 1.000V C.A.
Produto em conformidade com a NBR 9699 e NR10.

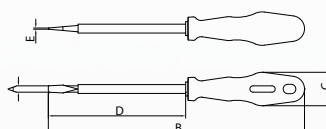

IPI 8% incluso - NCM: 8205.40.00

Hardened carbon steel blade.
Nickel plated finishing.
Injected handle.
Electrical insulation up to 1.000V A.C.

Asta en acero carbono templado.
Acabado niquelado.
Mango inyectado.
Aislamiento eléctrico hasta 1.000V C.A.



41509 Chave de Fenda para Eletrônica - Yellow - Ponta cruzada
Electronic Screwdriver - Yellow - Cross recessed tip
Destornillador para Eletrônica - Yellow - Punta cruzada



REF.	Tamanho Size <i>Tamaño</i>	EAN 789.1114	Embalagem Package <i>Embalaje</i>		Dimensões Dimensions (mm)					
			Un.	KG	Comp x larg x alt Length x width x height <i>Largo x ancho x altura</i>	A	B	C	D	E
41509/013	3x150mm (1/8x6")	01115 9	12	0,36	275 x 95 x 60mm	3	220	23	145	0,8
41509/014	3x200mm (1/8x8")	01116 6	12	0,46	390 x 110 x 80mm	3	280	23	205	0,8

Haste em aço carbono temperado.
Acabamento niquelado.
Cabo injetado.
Isolação elétrica de 1.000V C.A.
Produto em conformidade com a NBR 9699 e NR10.

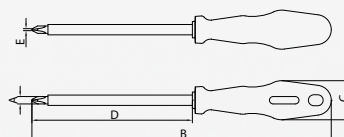

IPI 8% incluso - NCM: 8205.40.00

Hardened carbon steel blade.
Nickel plated finishing.
Injected handle.
Electrical insulation up to 1.000V A.C.

Asta en acero carbono templado.
Acabado niquelado.
Mango inyectado.
Aislamiento eléctrico hasta 1.000V C.A.

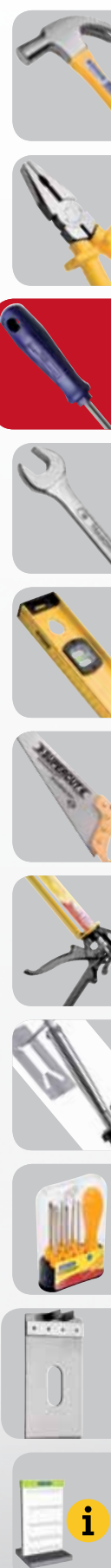
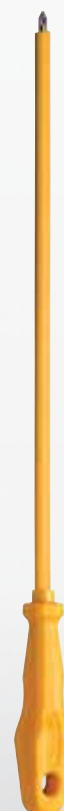



41516 Jogo de Chaves de Fenda - Yellow
Screwdriver Set - Yellow
Juego de Destornillador - Yellow

REF.	Peças Pieces Piezas	EAN 789.1114	Embalagem Package Embalaje		
			Un.	KG	Comp x larg x alt Length x width x height Largo x ancho x altura
41516/504	4	06044 7	6	1,34	320 x 190 x 100mm

Composição:

- 3 Chaves de fenda ponta chata 1/8x4", 3/16x4" e 1/4x5";
- Chave de fenda ponta cruzada 3/16x4";
- Embalagem blister.

IPI 8% incluso - NCM: 8205.40.00

Set includes:

- 3 Slotted tip screwdrivers: 1/8x4", 3/16x4" and 1/4x5".
- Cross recessed tip screwdriver: 3/16x4".
- Clam pack.

Composición:

- 3 Destornilladores punta chata: 1/8x4", 3/16x4" y 1/4x5".
- Destornillador punta cruzada: 3/16x4".
- Embalaje clam pack.



41516 Jogo de Chaves de Fenda - Yellow
Screwdriver Set - Yellow
Juego de Destornillador - Yellow

REF.	Peças Pieces Piezas	EAN 789.1114	Embalagem Package Embalaje		
			Un.	KG	Comp x larg x alt Length x width x height Largo x ancho x altura
41516/506	6	02992 5	6	1,50	345 x 156 x 138mm

Composição:

- 3 Chaves de fenda ponta chata 1/8x3", 3/16x3" e 3/16x4";
- 2 Chaves de fenda ponta cruzada 1/8x3" e 3/16x3";
- Chave de fenda clip ponta chata 1/8x3";
- Embalagem clam pack.

IPI 8% incluso - NCM: 8205.40.00

Set includes:

- 3 Slotted tip screwdrivers: 1/8x3", 3/16x3" and 3/16x4".
- 2 Cross recessed tip screwdrivers: 1/8x3" and 3/16x3".
- Slotted tip pocket screwdriver: 1/8x3".
- Clam pack.

Composición:

- 3 Destornilladores punta chata: 1/8x3", 3/16x3" y 3/16x4".
- 2 Destornilladores punta cruzada: 1/8x3" y 3/16x3".
- Destornillador clip: 1/8x3".
- Embalaje clam pack.

41516 Jogo de Chaves de Fenda - Basic Screwdriver Set - Basic Juego de Destornillador - Basic

REF.	Peças Pieces Piezas	EAN 789.1114	Embalagem Package Embalaje		
			Un.	KG	Comp x larg x alt Length x width x height Largo x ancho x altura
41516/425	5	04910 7	5	0,63	280 x 110 x 70mm

Composição:

- 2 Chaves de fenda ponta chata 1/8x3", 3/16x3";
- 2 Chaves de fenda ponta cruzada 1/8x3", 3/16x3";
- Chave clipe ponta chata 1/8x3".

Quantidade por caixa:

25 jogos distribuídos da seguinte forma dentro da caixa:

- 5 jogos na cor amarela
- 5 jogos na cor preta
- 5 jogos na cor azul
- 5 jogos na cor vermelha
- 5 jogos na cor verde

Obs.: Todos os jogos possuem a mesma referência.

IPI 8% incluso - NCM: 8205.40.00

Set includes:

- 2 Slotted tip screwdrivers: 1/8x3", 3/16x3";
- 2 Cross recessed tip screwdrivers: 1/8x3", 3/16x3";
- Slotted tip pocket screwdriver: 1/8x3".

Carton quantity:

- 25 sets as follows:
- 5 sets yellow color
 - 5 sets black color
 - 5 sets blue color
 - 5 sets red color
 - 5 sets green color

Remarks: same reference for all sets.

Composición:

- 2 Destornilladores punta chata: 1/8x3", 3/16x3";
- 2 Destornilladores punta cruzada: 1/8x3", 3/16x3";
- Destornillador clip: 1/8x3".

Cantidad por caja:

- 25 juegos conforme sigue:
- 5 juegos na cor amarela
 - 5 juegos na cor negra
 - 5 juegos na cor azul
 - 5 juegos na cor roja
 - 5 juegos na cor verde

Obs.: La misma referencia para todos los juegos.



41516 Jogo de Chaves de Fenda - Basic Screwdriver Set - Basic Juego de Destornillador - Basic

REF.	Peças Pieces Piezas	EAN 789.1114	Embalagem Package Embalaje		
			Un.	KG	Comp x larg x alt Length x width x height Largo x ancho x altura
41516/507	6	04252 8	6	1,65	345 x 156 x 138mm

Composição:

- 3 Chaves de fenda ponta chata 1/8x3", 1/4x4", 3/16x4";
- 2 Chaves de fenda ponta cruzada 1/8x3", 3/16x4";
- Chave clipe ponta chata 1/8x3";
- Embalagem clam pack.
- Grátis: suporte plástico para chaves de fenda.

IPI 8% incluso NCM: 8205.40.00

Set includes:

- 3 Slotted tip screwdrivers: 1/8x3", 3/16x4" and 1/4x4".
- 2 Cross recessed tip screwdrivers: 1/8x3" and 3/16x4".
- Slotted tip pocket screwdriver: 1/8x3".
- Plastic hanger.
- Clam pack.

Composición:

- 3 Destornilladores punta chata: 1/8x3", 3/16x4" y 1/4x4".
- 2 Destornilladores punta cruzada: 1/8x3" y 3/16x4".
- Destornillador clip: 1/8x3".
- Soporte de plástico.
- Embalaje clam pack.

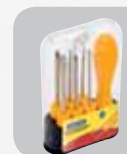
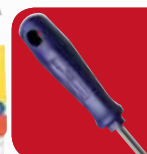



41520 Chave de Fenda - Basic - Ponta Chata
Screwdriver - Basic - Slotted tip
Destornilladores - Basic - Punta chata

REF.	Tamanho Size <i>Tamaño</i>	EAN 789.1114	Embalagem Package <i>Embalaje</i>			Dimensões Dimensions (mm)					
			Un.	KG	Comp x larg x alt Length x width x height <i>Largo x ancho x altura</i>	A	B	C	D	E	
SUPORTE PLÁSTICO PLASTIC HANGER <i>SOPORTE PLÁSTICO</i>											
41520/110	3x75mm (1/8x3")	05420 0	12	0,30	280 x 110 x 70mm	3,2	150	18	75	0,8	
41520/111	3x100mm (1/8x4")	05423 1	12	0,33	280 x 110 x 70mm	3,2	175	18	100	0,8	
41520/120	5x75mm (3/16x3")	06551 0	12	0,48	280 x 110 x 70mm	5,5	165	21	80	1,3	
41520/121	5x100mm (3/16x4")	05424 8	12	0,52	280 x 110 x 70mm	5,5	180	21	100	1,3	
41520/122	5x125mm (3/16x5")	05425 5	12	0,58	330 x 110 x 75mm	5,5	205	21	120	1,3	
41520/123	5x150mm (3/16x6")	05426 2	12	0,62	330 x 110 x 75mm	5,5	230	21	150	1,3	
41520/130	6x100mm (1/4x4")	05427 9	12	0,70	280 x 110 x 70mm	6,7	195	23,3	100	1,35	
41520/132	6x150mm (1/4x6")	05428 6	12	0,84	330 x 110 x 75mm	6,7	245	23,3	155	1,35	
41520/133	6x200mm (1/4x8")	05429 3	12	0,99	390 x 110 x 80mm	6,7	295	23,3	200	1,35	
41520/142	8x150mm (5/16x6")	05430 9	6	0,69	285 x 95 x 46mm	8,2	260	27,3	150	1,4	
41520/143	8x200mm (5/16x8")	05431 6	6	0,82	285 x 95 x 46mm	8,2	310	27,3	200	1,4	

Haste em aço carbono temperado.
Acabamento niquelado.
Cabo injetado.

IPI 8% incluso - NCM: 8205.40.00

Hardened carbon steel blade.
Nickel plated finishing.
Injected handle.

*Asta en acero carbono templado.
Acabado niquelado.
Mango inyectado.*

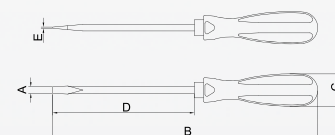

41525 Chave de Fenda - Basic - Ponta cruzada
Screwdriver - Basic - Cross recessed tip
Destornilladores - Basic - Punta cruzada



REF.	Tamanho Size <i>Tamaño</i>	EAN 789.1114	Embalagem Package <i>Embalaje</i>			Dimensões Dimensions (mm)				
			Un.	KG	Comp x larg x alt Length x width x height <i>Largo x ancho x altura</i>	A	B	C	D	E
SUPORTE PLÁSTICO PLASTIC HANGER <i>SOPORTE PLÁSTICO</i>										
41525/110	3x75mm (1/8x3")	05432 3	12	0,30	280 x 110 x 70mm	3	150	18	75	0,8
41525/111	3x125mm (1/8x5")	05433 0	12	0,37	330 x 110 x 75mm	3	200	18	125	0,8
41525/120	5x75mm (3/16x3")	05434 7	12	0,48	280 x 110 x 70mm	5	155	21	75	2
41525/121	5x100mm (3/16x4")	05435 4	12	0,52	280 x 110 x 70mm	5	185	21	100	2
41525/130	6x100mm (1/4x4")	05436 1	12	0,70	280 x 110 x 70mm	6	190	23,3	100	3
41525/131	6x150mm (1/4x6")	05437 8	12	0,84	330 x 110 x 75mm	6	245	23,3	150	3
41525/140	8x150mm (5/16x6")	05438 5	6	0,65	445 x 100 x 50mm	8	260	27,3	150	4,5

Haste em aço carbono temperado.
Acabamento niquelado.
Cabo injetado.

IPI 8% incluso - NCM: 8205.40.00

Hardened carbon steel blade.
Nickel plated finishing.
Injected handle.

Asta en acero carbono templado.
Acabado niquelado.
Mango inyectado.

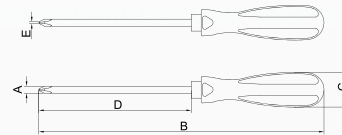



43408 Jogo de Chaves de Fenda - Basic
Screwdriver Set - Basic
Juego de Destornillador - Basic

REF.	Peças Pieces Piezas	EAN 789.1114	Embalagem Package Embalaje		
			Un.	KG	Comp x larg x alt Length x width x height Largo x ancho x altura
43408/334	4	05942 7	12	2,15	368 x 190 x 97mm

Composição:

- 3 Chaves de fenda ponta chata 1/8x4", 3/16x5", 1/4x6";
- Chave de fenda ponta cruzada 3/16x4";
- Embalagem encartelado.

IPI 8% incluso - NCM: 8205.40.00

Set includes:

- 3 Slotted tip screwdrivers: 1/8x4", 3/16x5" and 1/4x6".
- Cross recessed tip screwdrivers: 3/16x4".
- Clam pack.

Composición:

- 3 Destornilladores punta chata: 1/8x4", 3/16x5" y 1/4x6".
- Destornillador punta cruzada: 3/16x4".
- Clam pack.



41526 Jogo de Chaves de Fenda - Basic
Screwdriver Set - Basic
Juego de Destornillador - Basic

REF.	Peças Pieces Piezas	EAN 789.1114	Embalagem Package Embalaje		
			Un.	KG	Comp x larg x alt Length x width x height Largo x ancho x altura
41526/506	6	05439 2	6	1,12	345 x 156 x 138mm

Composição:

- 4 Chaves de fenda ponta chata 1/8x3", 1/8x4", 3/16x4", 1/4x4";
- 2 Chaves de fenda ponta cruzada 1/8x3", 3/16x3";
- Embalagem clam pack.

IPI 8% incluso - NCM: 8205.40.00

Set includes:

- 4 Slotted tip screwdrivers: 1/8x3", 1/8x4", 3/16x4" and 1/4x4".
- 2 Cross recessed tip screwdrivers: 1/8x3" and 3/16x3".
- Clam pack.

Composición:

- 4 Destornilladores punta chata: 1/8x3", 1/8x4", 3/16x4" y 1/4x4".
- 2 Destornilladores punta cruzada: 1/8x3" y 3/16x3".
- Embalaje clam pack.

41990 Chaveirinho - Basic - Ponta chata
Screwdriver - Basic - Slotted tip
Destornilladores - Basic - Punta chata



REF.	Tamanho Size <i>Tamaño</i>	EAN 789.1114	Embalagem Package <i>Embalaje</i>			Dimensões Dimensions (mm)			
			Un.	KG	Comp x larg x alt Length x width x height <i>Largo x ancho x altura</i>	A	B	C	D
41990/000	5x30mm (3/16x1")	01126 5	100	1,08	275 x 95 x 60mm	20,5	65,5	5,5	7,5
			600	6,89	350 x 340 x 140mm				

Haste em aço carbono temperado.
Acabamento niquelado.
Cabo injetado.

IPI 8% incluso - NCM: 8205.40.00

Hardened carbon steel blade.
Nickel plated finishing.
Injected handle.

Asta en acero carbono templado.
Acabado niquelado.
Mango inyectado.

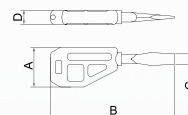

41900 Chave Teste - Ponta chata
Voltage Tester - Slotted tip
Llave Test - Punta chata



REF.	Tamanho Size <i>Tamaño</i>	EAN 789.1114	Embalagem Package <i>Embalaje</i>			Dimensões Dimensions (mm)			
			Un.	KG	Comp x larg x alt Length x width x height <i>Largo x ancho x altura</i>	A	B	C	D
SUPORTE PLÁSTICO PLASTIC HANGER <i>SOPORTE PLÁSTICO</i>									
41900/110	3x75mm (1/8x3")	00580 6	12	0,40	280 x 110 x 75mm	3	143	15	19,5

Haste em aço carbono temperado.
Acabamento niquelado.
Cabo injetado.
Circuito elétrico ativado através de botão na extremidade do cabo.
Lâmpada de neon;
Apropriada para 80 - 250V.

IPI 5% incluso - NCM: 9030.39.90

Hardened carbon steel blade.
Nickel plated finishing.
Injected handle.
Electrical circuit activated by the button on the handle's edge.
Neon light.
Suitable for 80 - 250V.

Asta en acero carbono templado.
Acabado niquelado.
Mango inyectado.
Circuito eléctrico activado a través del boton en la extremidad del mango.
Lâmpada de neón.
Adecuado para 80 - 250V.

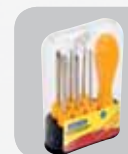
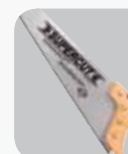
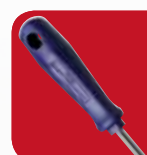
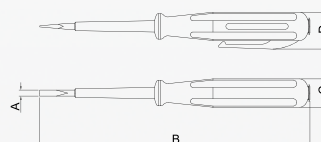



CHAVES DE APERTO WRENCHES AND SPANNERS LLAVES DE AJUSTE



42005 Chave Fixa - Polegadas
Open end Wrench - Inches
Llave Fija - Pulgadas



REF.	Tamanho Size <i>Tamaño</i>	EAN 789.1114	Embalagem Package <i>Embalaje</i>			Dimensões Dimensions (mm)	
			Un.	KG	Comp x larg x alt Length x width x height <i>Largo x ancho x altura</i>	A	B
SUPORTE PLÁSTICO PLASTIC HANGER <i>SOPORTE PLÁSTICO</i>							
42005/100	1/4x5/16"	00890 6	12	0,48	260 x 90 x 55mm	3,7	127
42005/101	3/8x7/16"	00891 3	12	0,78	260 x 90 x 55mm	5	153
42005/102	1/2x9/16"	00892 0	12	0,99	290 x 100 x 65mm	5,5	166
42005/103	5/8x11/16"	00893 7	6	0,78	263 x 86 x 53mm	6,5	195
42005/104	3/4x25/32"	00894 4	6	1,05	275 x 95 x 60mm	7,5	210
42005/105	13/16x7/8"	00895 1	6	1,34	330 x 110 x 75mm	8	225
42005/106	15/16x1"	00896 8	6	2,10	365 x 125 x 80mm	9	258
42005/107	1.1/16x1.1/4"	00897 5	6	2,93	365 x 125 x 80mm	10	294

Corpo forjado em aço carbono e temperado.
Acabamento cromado.
Abertura das bocas calibradas.

IPI 8% incluso - NCM: 8204.11.00

Forged and hardened carbon steel body.
Chrome plated finishing.
Calibrated openings.

Cuerpo forjado en acero carbono templado.
Acabado cromado.
Apertura de las bocas calibradas.

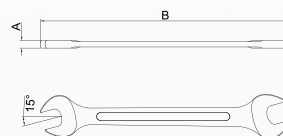

42006 Chave Fixa - Milímetros
Open end Wrench - Millimeters
Llave Fija - Milímetros

REF.	Tamanho Size <i>Tamaño</i>	EAN 789.1114	Embalagem Package <i>Embalaje</i>			Dimensões Dimensions (mm)	
			Un.	KG	Comp x larg x alt Length x width x height <i>Largo x ancho x altura</i>	A	B
SUPORTE PLÁSTICO PLASTIC HANGER <i>SOPORTE PLÁSTICO</i>							
42006/101	6x7mm	00898 2	12	0,48	265 x 90 x 60mm	3,7	127
42006/102	8x9mm	00899 9	12	0,60	265 x 90 x 60mm	4	140
42006/103	10x11mm	00900 2	12	1,64	260 x 100 x 60mm	5	153
42006/104	12x13mm	00901 9	12	1,96	290 x 100 x 65mm	5,5	166
42006/105	14x15mm	00902 6	12	2,60	290 x 100 x 65mm	6	180
42006/106	16x17mm	00903 3	6	0,80	263 x 86 x 53mm	6,5	195
42006/107	18x19mm	00904 0	6	1,05	285 x 95 x 46mm	7,5	210
42006/108	20x22mm	00905 7	6	1,36	336 x 110 x 75mm	8	225
42006/109	21x23mm	00906 4	6	1,52	340 x 110 x 50mm	8	240
42006/110	24x26mm	00907 1	6	2,10	400 x 115 x 65mm	9	258
42006/111	25x28mm	00908 8	6	2,41	365 x 125 x 80mm	9	276
42006/112	27x32mm	00909 5	6	2,90	390 x 130 x 85mm	10	294
42006/113	30x32mm	06545 9	6	3,05	390 x 110 x 80mm	10	305

Corpo forjado em aço carbono e temperado.
Acabamento cromado.
Abertura das bocas calibradas.

IPI 8% incluso - NCM: 8204.11.00

Forged and hardened carbon steel body.
Chrome plated finishing.
Calibrated openings.

Cuerpo forjado en acero carbono templado.
Acabado cromado.
Apertura de las bocas calibradas.

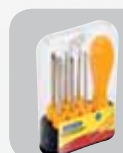
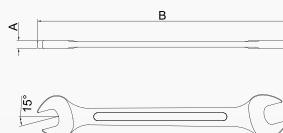



42000 Jogo de Chaves Fixas - Polegadas
Open End Wrench Set - Inches
Juego de Llaves Fijas - Pulgadas

REF.	Peças Pieces Piezas	EAN 789.1114	Embalagem Package Embalaje		
			Un.	KG	Comp x larg x alt Length x width x height Largo x ancho x altura
42000/208	8	00015 3	1	1,50	290 x 80 x 60mm
			6	9,27	300 x 250 x 145mm

Composição | Set includes | *Composición:*

- 1/4x5/16", 3/8x7/16", 1/2x9/16", 5/8x11/16", 3/4x25/32", 13/16x7/8", 15/16x1", 1.1/16x1.1/4"
- Embalagem plástica de enrolar | Plastic roll pouch | *embalaje plástica.*

IPI 8% incluso - NCM: 8204.11.00



42001 Jogo de Chaves Fixas - Milímetros
Open End Wrench Set - Millimeters
Juego de Llaves Fijas - Milímetros

REF.	Peças Pieces Piezas	EAN 789.1114	Embalagem Package Embalaje		
			Un.	KG	Comp x larg x alt Length x width x height Largo x ancho x altura
42001/108	8	01420 4	1		
			6	5,33	400 x 245 x 140mm

Composição | Set includes | *Composición:*

- 6x7, 8x9, 10x11, 12x13, 14x15, 16x17, 18x19, 20x22mm.
- Embalagem plástica, que pode ser usada para transporte ou pendurar na parede | Practical plastic hanger | *soporte plástico práctico.*

IPI 8% incluso - NCM: 8204.11.00



42001 Jogo de Chaves Fixas - Milímetros
Open End Wrench Set - Millimeters
Juego de Llaves Fijas - Milímetros

REF.	Peças Pieces Piezas	EAN 789.1114	Embalagem Package Embalaje		
			Un.	KG	Comp x larg x alt Length x width x height Largo x ancho x altura
42001/118	8	05320 3	1		
			6	4,98	335 x 190 x 145mm

Composição | Set includes | *Composición:*

- 6x7, 8x9, 10x11, 12x13, 14x15, 16x17, 18x19, 20x22mm.
- Clipe plástico para guardar as ferramentas | Plastic clip to store the wrenches | *soporte plástico clip para almacenar las herramientas.*
- Clam pack.

IPI 8% incluso - NCM: 8204.11.00

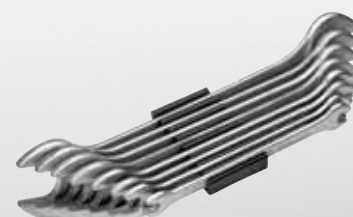

42001 Jogo de Chaves Fixas - Milímetros Open End Wrench Set - Millimeters Juego de Llaves Fijas - Milímetros

REF.	Peças Pieces Piezas	EAN 789.1114	Embalagem Package Embalaje		
			Un.	KG	Comp x larg x alt Length x width x height Largo x ancho x altura
42001/206	6	00016 0	1	0,46	210 x 55 x 50mm
			6	2,81	230 x 200 x 105mm
42001/208	8	00017 7	1	0,83	260 x 65 x 45mm
			6	5,02	320 x 190 x 100mm
42001/212	12	00018 4	1	2,28	310 x 105 x 60mm
			6	14,60	338 x 308 x 136mm

Composição | Set includes | Composición:

42001/206: 6x7, 8x9, 10x11, 12x13, 14x15, 16x17mm.

42001/208: 6x7, 8x9, 10x11, 12x13, 14x15, 16x17, 18x19, 20x22mm.

42001/212: 6x7, 8x9, 10x11, 12x13, 14x15, 16x17, 18x19, 20x22, 21x23, 24x26, 25x28, 27x32mm.

- Embalagem plástica de enrolar | Plastic roll pouch | *embalaje plástica.*

IPI 8% incluso - NCM: 8204.11.00

42001 Jogo de Chaves Fixas - Milímetros Open End Wrench Set - Millimeters Juego de Llaves Fijas - Milímetros

REF.	Peças Pieces Piezas	EAN 789.1114	Embalagem Package Embalaje		
			Un.	KG	Comp x larg x alt Length x width x height Largo x ancho x altura
42001/506	6	03509 4	1	0,41	270 x 110 x 40mm
			6	2,64	320 x 190 x 100mm

Composição | Set includes | Composición:

- 6x7, 8x9, 10x11, 12x13, 14x15 e 16x17mm.
- Embalagem clam pack.

IPI 8% incluso - NCM: 8204.11.00

42001 Jogo de Chaves Fixas - Milímetros Open End Wrench Set - Millimeters Juego de Llaves Fijas - Milímetros

REF.	Peças Pieces Piezas	EAN 789.1114	Embalagem Package Embalaje		
			Un.	KG	Comp x larg x alt Length x width x height Largo x ancho x altura
42001/514	4	06091 1	1	0,28	260 x 155 x 15mm
			6	1,73	280 x 170 x 95mm

Composição | Set includes | Composición:

- 8x9, 10x11, 12x13, 14x15mm.
- Blister.

IPI 8% incluso - NCM: 8204.11.00

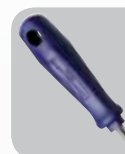



41120 Chave Fixa - Basic - Milímetros
Open end Wrench - Basic - Millimeters
Llave Fija - Basic - Milímetros

REF.	Tamanho Size <i>Tamaño</i>	EAN 789.1114	Embalagem Package <i>Embalaje</i>		Dimensões Dimensions (mm)	
			Un.	KG	Comp x larg x alt Length x width x height <i>Largo x ancho x altura</i>	A
SUPORTE PLÁSTICO PLASTIC HANGER <i>SOPORTE PLÁSTICO</i>						
41120/101	6x7mm	06344 8	12	0,38	260 x 90 x 55mm	4,1 111
41120/102	8x9mm	06345 5	12	0,47	260 x 90 x 55mm	4,6 118
41120/103	10x11mm	06346 2	12	0,58	260 x 90 x 55mm	5,5 125
41120/104	12x13mm	06347 9	12	0,73	290 x 100 x 65mm	5,9 135
41120/105	14x15mm	06348 6	12	0,88	290 x 100 x 65mm	6,4 150
41120/106	16x17mm	06349 3	6	0,31	248 x 100 x 58mm	6,6 164
41120/107*	18x19mm	09288 2	6	1,05	285 x 95 x 46mm	6,8 184
41120/108*	20x22mm	09289 9	6	1,36	336 x 110 x 75mm	7,0 195
41120/109*	21x23mm	09290 5	6	1,52	340 x 100 x 50mm	7,0 211
41120/110*	24x26mm	09291 2	6	2,10	400 x 115 x 65mm	8,0 227
41120/111*	25x28mm	09292 9	6	2,41	365 x 125 x 80mm	8,5 244
41120/112*	27x32mm	09293 6	6	2,90	390 x 130 x 85mm	9,5 268
41120/113*	30x32mm	09404 6	6	3,24	390 x 130 x 85mm	9,5 286

Corpo forjado em aço carbono e temperado.
Acabamento cromado.
Abertura das bocas calibradas.

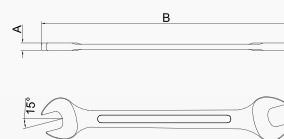

IPI 8% incluso - NCM: 8204.11.00

Forged and hardened carbon steel body.
Chrome plated finishing.
Calibrated openings.



Cuerpo forjado en acero carbono templado.
Acabado cromado.
Apertura de las bocas calibradas.

41120 Jogo de Chaves Fixas - Basic - Milímetros
Open End Wrench Set - Basic - Millimeters
Juego de Llaves Fijas - Basic Milímetros



REF.	Peças Pieces <i>Piezas</i>	EAN 789.1114	Embalagem Package <i>Embalaje</i>		Comp x larg x alt Length x width x height <i>Largo x ancho x altura</i>
			Un.	KG	
41120/205	5	07186 3	1	0,31	220 x 90 x 45mm
			6	2,14	255 x 240 x 110mm
41120/208*	8	09425 1	1	0,83	260 x 65 x 45mm
			6	5,02	320 x 190 x 100mm
41120/212*	12	09426 8	1	2,28	310 x 105 x 60mm
			6	14,60	338 x 308 x 136mm

Composição | Set includes | *Composición:*

41120/205: 8x9, 10x11, 12x13, 14x15, 16x17mm.
41120/208: 6x7, 8x9, 10x11, 12x13, 14x15, 16x17, 18x19, 20x22mm.
41120/212: 6x7, 8x9, 10x11, 12x13, 14x15, 16x17, 18x19, 20x22, 21x23, 24x26, 25x28, 27x32mm.

• Embalagem plástica de enrolar | Plastic roll pouch | *embalaje plástica.*

IPI 8% incluso - NCM: 8204.11.00



42025 Chave Estrela - Polegadas
Ring Spanner - Inches
Llave Estriada - Pulgadas

REF.	Tamanho Size <i>Tamaño</i>	EAN 789.1114	Embalagem Package <i>Embalaje</i>			Dimensões Dimensions (mm)			
			Un.	KG	Comp x larg x alt Length x width x height <i>Largo x ancho x altura</i>	A	B	C	D
SUPORTE PLÁSTICO PLASTIC HANGER <i>SOPORTE PLÁSTICO</i> 									
42025/101	3/8x7/16"	00918 7	12	1,37	320 x 160 x 80mm	7,7	200	8,5	23,65
42025/102	1/2x9/16"	00919 4	12	1,95	365 x 125 x 80mm	9,5	230	10	25,30

Corpo forjado em aço carbono e temperado.
Acabamento cromado.
Abertura das bocas calibradas.

IPI 8% incluso - NCM: 8204.11.00

Forged and hardened carbon steel body.
Chrome plated finishing.
Calibrated openings.

Cuerpo forjado en acero carbono templado.
Acabado cromado.
Apertura de las bocas calibradas.

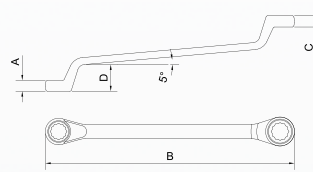

42026 Chave Estrela - Milímetros
Ring Spanner - Millimeters
Llave Estriada - Milímetros

REF.	Tamanho Size <i>Tamaño</i>	EAN 789.1114	Embalagem Package <i>Embalaje</i>			Dimensões Dimensions (mm)			
			Un.	KG	Comp x larg x alt Length x width x height <i>Largo x ancho x altura</i>	A	B	C	D
SUPORTE PLÁSTICO PLASTIC HANGER <i>SOPORTE PLÁSTICO</i> 									
42026/101	6x7mm	00910 1	12	0,89	330 x 110 x 75mm	5,5	175	6	20,24
42026/102	8x9mm	00911 8	12	1,02	330 x 110 x 75mm	6,5	185	7	21,82
42026/103	10x11mm	00912 5	12	1,38	365 x 125 x 80mm	7,7	200	8,5	23,65
42026/104	12x13mm	00913 2	12	1,70	365 x 125 x 80mm	9	215	9,5	25,33
42026/105	14x15mm	00914 9	12	2,17	400 x 140 x 90mm	10	230	10,5	26,68
42026/106	16x17mm	00915 6	6	1,40	330 x 110 x 75mm	11	250	11,5	28,40
42026/107	18x19mm	00916 3	6	1,79	390 x 105 x 78mm	12	270	12,5	31,08
42026/108	20x22mm	00917 0	6	2,30	390 x 105 x 78mm	13	290	13,5	32,57
42026/109	21x23mm	01468 6	6	2,68	430 x 90 x 120mm	13,5	310	14	33,19
42026/110	24x26mm	01469 3	6	3,23	430 x 150 x 95mm	14	335	14,5	34,71
42026/111	25x28mm	01470 9	6	3,78	430 x 150 x 95mm	14	355	15	35,60
42026/112	27x32mm	01471 6	6	4,30	500 x 100 x 150mm	14,5	375	16	36,36

Corpo forjado em aço carbono e temperado.
Acabamento cromado.
Abertura das bocas calibradas.

IPI 8% incluso - NCM: 8204.11.00

Forged and hardened carbon steel body.
Chrome plated finishing.
Calibrated openings.

Cuerpo forjado en acero carbono templado.
Acabado cromado.
Apertura de las bocas calibradas.

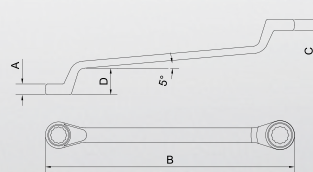



42021 Jogo de Chaves Estrela - Milímetros
Ring Spanner Set - Millimeters
Juego de Llaves Estriadas - Milímetros

REF.	Peças Pieces Piezas	EAN 789.1114	Embalagem Package Embalaje		
			Un.	KG	Comp x larg x alt Length x width x height Largo x ancho x altura
42021/208	8	00020 7	1	1,46	310 x 105 x 60mm
			6	9,03	380 x 235 x 210mm
42021/212	12	00021 4	1	3,64	410 x 110 x 90mm
			6	22,59	435 x 360 x 190mm

Composição | Set includes | *Composición:*

42021/208: 6x7, 8x9, 10x11, 12x13, 14x15, 16x17, 18x19, 20x22mm.

42021/212: 6x7, 8x9, 10x11, 12x13, 14x15, 16x17, 18x19, 20x22, 21x23, 24x26, 25x28, 27x32mm.

- Embalagem plástica de enrolar | Plastic roll pouch | *embalaje plástica.*

IPI 8% incluso - NCM: 8204.11.00



42021 Jogo de Chaves Estrela - Milímetros
Ring Spanner Set - Millimeters
Juego de Llaves Estriadas - Milímetros

REF.	Peças Pieces Piezas	EAN 789.1114	Embalagem Package Embalaje		
			Un.	KG	Comp x larg x alt Length x width x height Largo x ancho x altura
42021/514	4	06041 6	1	0,48	310 x 155 x 25mm
			6	3,045	320 x 190 x 100mm

Composição | Set includes | *Composición:*

- 8x9, 10x11, 12x13, 14x15mm.
- Blister.

IPI 8% incluso - NCM: 8204.11.00

42245 Chave Combinada - Polegadas
Combination Wrench - Inches
Llave Combinada - Pulgadas

REF.	Tamanho Size <i>Tamaño</i>	EAN 789.1114	Embalagem Package <i>Embalaje</i>			Dimensões Dimensions (mm)			
			Un.	KG	Comp x larg x alt Length x width x height <i>Largo x ancho x altura</i>	A	B	C	D
SUPORTE PLÁSTICO PLASTIC HANGER <i>SOPORTE PLÁSTICO</i>									
42245/100	1/4"	01665 9	12	0,44	265 x 90 x 60mm	4	125	6	
42245/101	5/16"	01666 6	12	0,55	265 x 90 x 60mm	4,5	140	7	
42245/102	3/8"	01367 2	12	0,79	290 x 100 x 60mm	5	155	8,2	
42245/103	7/16"	01368 9	12	0,89	280 x 110 x 75mm	5,5	162,5	8,9	
42245/104	1/2"	01369 6	12	1,12	280 x 110 x 75mm	5,8	180	9,6	
42245/105	9/16"	01370 2	12	1,32	280 x 110 x 75mm	5,8	190	10	
42245/106	5/8"	01667 3	6	0,83	290 x 97 x 60mm	6	210	11	
42245/107	11/16"	01668 0	6	1,02	290 x 97 x 60mm	6,3	222	11,5	
42245/108	3/4"	01669 7	6	1,29	330 x 110 x 75mm	7	244	12,5	
42245/109	25/32"	01670 3	6	1,65	390 x 105 x 78mm	7,4	256	13	
42245/110	13/16"	01671 0	6	1,76	390 x 105 x 78mm	7,7	268	13,5	
42245/111	7/8"	01672 7	6	1,86	390 x 105 x 78mm	7,8	280	13,5	
42245/112	15/16"	01673 4	6	2,21	365 x 125 x 80mm	8,2	307	14	
42245/113	1"	01674 1	6	2,44	365 x 125 x 80mm	8,5	322	14	
42245/114	1.1/16"	01675 8	6	3,21	430 x 90 x 120mm	9,2	352	14,5	
42245/115	1.1/8"	01676 5	6	3,44	420 x 150 x 95mm	9,6	370	15	
42245/116	1.3/16"	01677 2	6	4,10	430 x 90 x 120mm	10	390	15	
42245/117	1.1/4"	01678 9	6	4,31	420 x 165 x 120mm	10,4	412	16	

Corpo forjado em aço carbono e temperado.
Acabamento cromado.
Abertura das bocas calibradas.
Pescoço longo.

IPI 8% incluso - NCM: 8204.11.00

Forged and hardened carbon steel body.
Chrome plated finishing.
Calibrated openings.
Long neck.

Cuerpo forjado en acero carbono templado.
Acabado cromado.
Apertura de las bocas calibradas.
Cuello largo.

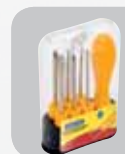
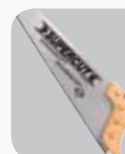
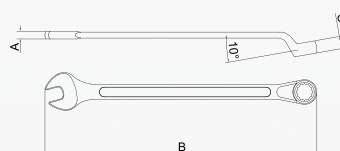



42246 Chave Combinada - Milímetros
Combination Wrench - Millimeters
Llave Combinada - Milímetros

REF.	Tamanho Size <i>Tamaño</i>	EAN 789.1114	Embalagem Package <i>Embalaje</i>			Dimensões Dimensions (mm)		
			Un.	KG	Comp x larg x alt Length x width x height <i>Largo x ancho x altura</i>	A	B	C
SUPORTE PLÁSTICO PLASTIC HANGER <i>SOPORTE PLÁSTICO</i>								
42246/106	6mm	00920 0	12	0,42	260 x 90 x 60mm	4	125	6
42246/107	7mm	00921 7	12	0,46	260 x 90 x 60mm	4	132,5	6,5
42246/108	8mm	00922 4	12	0,54	260 x 90 x 60mm	4,5	140	7
42246/109	9mm	00923 1	12	0,64	290 x 100 x 60mm	4,5	147,5	7,5
42246/110	10mm	00924 8	12	0,81	290 x 100 x 60mm	5	155	8,2
42246/111	11mm	00925 5	12	0,87	290 x 100 x 60mm	5,5	162,5	8,9
42246/112	12mm	00926 2	12	1,02	280 x 120 x 70mm	5,5	170	9,3
42246/113	13mm	00927 9	12	1,09	280 x 120 x 70mm	5,8	180	9,6
42246/114	14mm	00928 6	12	1,34	400 x 120 x 65mm	5,8	190	10
42246/115	15mm	00929 3	12	1,43	400 x 120 x 65mm	5,9	200	10,5
42246/116	16mm	00930 9	6	0,84	275 x 95 x 60mm	6	210	11
42246/117	17mm	00931 6	6	0,90	290 x 97 x 60mm	6,3	222	11,5
42246/118	18mm	00932 3	6	1,14	340 x 110 x 50mm	6,6	234	12
42246/119	19mm	00933 0	6	1,32	330 x 110 x 75mm	7	244	12,5
42246/120	20mm	00934 7	6	1,50	390 x 105 x 78mm	7,4	256	13
42246/121	21mm	00935 4	6	1,65	390 x 105 x 78mm	7,7	268	13,5
42246/122	22mm	00936 1	6	1,89	360 x 105 x 78mm	7,8	280	13,5
42246/123	23mm	01472 3	6	2,05	390 x 105 x 78mm	8	292	14
42246/124	24mm	01473 0	6	2,23	400 x 120 x 65mm	8,2	307	14
42246/125	25mm	01474 7	6	2,46	400 x 120 x 65mm	8,5	322	14
42246/126	26mm	01475 4	6	2,71	400 x 120 x 65mm	8,7	337	14,5
42246/127	27mm	01476 1	6	3,14	420 x 150 x 95mm	9,2	352	14,5
42246/128	28mm	01477 8	6	3,39	420 x 150 x 95mm	9,6	370	15
42246/130	30mm	01478 5	6	3,78	430 x 90 x 120mm	10	390	15
42246/132	32mm	01479 2	6	4,21	430 x 90 x 120mm	10,4	412	16

Corpo forjado em aço carbono e temperado.
Acabamento cromado.
Abertura das bocas calibradas.
Pescoço longo.

IPI 8% incluso - NCM: 8204.11.00

Forged and hardened carbon steel body.
Chrome plated finishing.
Calibrated openings.
Long neck.

*Cuerpo forjado en acero carbono templado.
Acabado cromado.
Apertura de las bocas calibradas.
Cuello largo.*

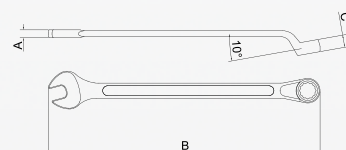

42240 Jogo de Chaves Combinadas - Polegadas
Combination Wrench Set - Inches
Juego de Llaves Combinadas - Pulgadas

REF.	Peças Pieces Piezas	EAN 789.1114	Embalagem Package Embalaje		
			Un.	KG	Comp x larg x alt Length x width x height Largo x ancho x altura
42240/108	8	02203 2	6	5,47	435 x 255 x 125mm

Composição | Set includes | *Composición:*

- 5/16", 3/8", 7/16", 1/2", 9/16", 5/8", 11/16", 3/4".
- Embalagem plástica que pode ser usada para transporte ou pendurar na parede | Practical plastic hanger | *soporte plástico práctico.*

IPI 8% incluso - NCM: 8204.11.00



42240 Jogo de Chaves Combinadas - Polegadas
Combination Wrench Set - Inches
Juego de Llaves Combinadas - Pulgadas

REF.	Peças Pieces Piezas	EAN 789.1114	Embalagem Package Embalaje		
			Un.	KG	Comp x larg x alt Length x width x height Largo x ancho x altura
42240/216	16	02185 1	1	4,05	410 x 110 x 90mm
			6	24,41	435 x 360 x 190mm

Composição | Set includes | *Composición:*

- 1/4", 5/16", 3/8", 7/16", 1/2", 9/16", 5/8", 11/16", 3/4", 13/16", 7/8", 15/16", 1", 1.1/16", 1.1/8", 1.1/4".
- Embalagem plástica de enrolar | Plastic roll pouch | *embalaje plástica.*

IPI 8% incluso - NCM: 8204.11.00



42241 Jogo de Chaves Combinadas - Milímetros
Combination Wrench Set - Millimeters
Juego de Llaves Combinadas - Milímetros

REF.	Peças Pieces Piezas	EAN 789.1114	Embalagem Package Embalaje		
			Un.	KG	Comp x larg x alt Length x width x height Largo x ancho x altura
42241/108	8	01422 8	6	4,17	435 x 255 x 125mm
42241/110	10	01423 5	6	5,01	435 x 255 x 125mm

Composição | Set includes | *Composición:*

42241/108: 8, 9, 10, 11, 12, 13, 14, 17mm.

42241/110: 6, 7, 8, 10, 11, 12, 13, 14, 16, 17mm.

- Embalagem plástica que pode ser usada para transporte ou pendurar na parede | Practical plastic hanger | *soporte plástico práctico.*

IPI 8% incluso - NCM: 8204.11.00

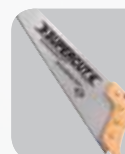
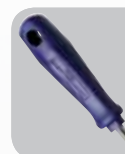



42241 Jogo de Chaves Combinadas - Milímetros
Combination Wrench Set - Millimeters
Juego de Llaves Combinadas - Milímetros

REF.	Peças Pieces Piezas	EAN 789.1114	Embalagem Package Embalaje		
			Un.	KG	Comp x larg x alt Length x width x height Largo x ancho x altura
42241/118	8	05321 0	6	7,68	445 x 280 x 140mm

Composição | Set includes | *Composición:*

- 8, 9, 10, 11, 12, 13, 14, 17mm.
- Clipe plástico para guardar as ferramentas | Plastic clip to store the wrenches
| soporte plástico clip para almacenar las herramientas.
- Clam pack.



IPI 8% incluso - NCM: 8204.11.00



42241 Jogo de Chaves Combinadas - Milímetros
Combination Wrench Set - Millimeters
Juego de Llaves Combinadas - Milímetros

REF.	Peças Pieces Piezas	EAN 789.1114	Embalagem Package Embalaje		
			Un.	KG	Comp x larg x alt Length x width x height Largo x ancho x altura
42241/206	6	00091 7	1	0,43	210 x 55 x 50mm
			6	2,73	230 x 200 x 105mm
42241/208	8	00092 4	1	0,66	290 x 80 x 60mm
			6	4,12	300 x 250 x 145mm
42241/210	10	00093 1	1	0,80	290 x 80 x 60mm
			6	4,88	300 x 250 x 145mm
42241/212	12	00094 8	1	1,21	290 x 80 x 60mm
			6	7,47	300 x 250 x 145mm
42241/215	15	00680 3	1	3,37	410 x 110 x 90mm
			6	20,60	435 x 360 x 190mm
42241/217	17	00095 5	1	2,11	310 x 105 x 60mm
			6	13,03	350 x 340 x 140mm

Composição | Set includes | *Composición:*

- 42241/206: 8, 10, 11, 12, 13, 14mm.
- 42241/208: 8, 9, 10, 11, 12, 13, 14, 17mm.
- 42241/210: 6, 7, 8, 10, 11, 12, 13, 14, 16, 17mm.
- 42241/212: 6, 7, 8, 9, 10, 11, 12, 13, 14, 17, 19, 22mm.
- 42241/215: 6, 7, 8, 10, 11, 12, 13, 14, 17, 19, 22, 24, 27, 30, 32mm.
- 42241/217: 6, 7, 8, 9, 10, 11, 12, 13, 14, 15, 16, 17, 18, 19, 20, 21, 22mm

- Embalagem plástica de enrolar | Plastic roll pouch | *embalaje plástica.*

IPI 8% incluso - NCM: 8204.11.00

42241 Jogo de Chaves Combinadas - Milímetros
Combination Wrench Set - Millimeters
Juego de Llaves Combinadas - Milímetros

REF.	Peças Pieces Piezas	EAN 789.1114	Embalagem Package Embalaje		
			Un.	KG	Comp x larg x alt Length x width x height Largo x ancho x altura
42241/506	6	03510 0	1	0,40	270 x 110 x 30mm
			6	2,50	280 x 170 x 95mm

Composição | Set includes | *Composición:*

- 8, 10, 11, 12, 13, 14mm
- Clam pack

IPI 8% incluso - NCM: 8204.11.00



42241 Jogo de Chaves Combinadas - Milímetros
Combination Wrench Set - Millimeters
Juego de Llaves Combinadas - Milímetros

REF.	Peças Pieces Piezas	EAN 789.1114	Embalagem Package Embalaje		
			Un.	KG	Comp x larg x alt Length x width x height Largo x ancho x altura
42241/514	4	06040 9	1	0,24	260 x 155 x 15mm
			6	1,52	280 x 170 x 95mm

Composição | Set includes | *Composición:*

- 8, 10, 11, 12mm.
- Blister.

IPI 8% incluso - NCM: 8204.11.00

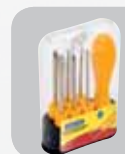



41128 Chave Combinada - Basic - Milímetros
Combination Wrench - Basic - Millimeters
Llave Combinada - Basic - Milímetros

REF.	Tamanho Size <i>Tamaño</i>	EAN 789.1114	Embalagem Package <i>Embalaje</i>			Dimensões Dimensions (mm)			
			Un.	KG	Comp x larg x alt Length x width x height <i>Largo x ancho x altura</i>	A	B	C	D
SUPORTE PLÁSTICO PLASTIC HANGER <i>SOPORTE PLÁSTICO</i>									
41128/110	10mm	06354 7	12	0,69	260 x 90 x 55mm	5,0	140	8,2	
41128/111	11mm	06355 4	12	0,82	290 x 100 x 65mm	5,5	147	8,9	
41128/112	12mm	06356 1	12	0,87	290 x 100 x 65mm	5,5	155	9,3	
41128/113	13mm	06357 8	12	1,02	290 x 100 x 65mm	5,8	165	9,6	
41128/114	14mm	06358 5	12	1,16	290 x 100 x 65mm	5,8	175	10,0	
41128/115	15mm	06359 2	12	1,29	280 x 110 x 65mm	5,9	185	10,5	
41128/116	16mm	06360 8	6	0,74	275 x 95 x 60mm	6,0	195	11,0	
41128/117	17mm	06361 5	6	0,86	175 x 95 x 60mm	6,3	207	11,5	
41128/118	18mm	06660 9	6	0,98	290 x 97 x 60mm	6,6	219	12,0	
41128/119	19mm	06661 6	6	1,15	330 x 110 x 75mm	7,0	229	12,5	
41128/120*	20mm	09311 7	6	1,50	390 x 105 x 78mm	7,4	241	13,0	
41128/121*	21mm	09312 4	6	1,65	390 x 105 x 78mm	7,7	253	13,5	
41128/122*	22mm	09313 1	6	1,89	360 x 105 x 78mm	7,8	265	13,5	
41128/123*	23mm	09314 8	6	2,05	390 x 105 x 78mm	8,0	292	14,0	
41128/124*	24mm	09315 5	6	2,23	400 x 120 x 65mm	8,2	307	14,0	
41128/125*	25mm	09316 2	6	2,46	400 x 120 x 65mm	8,5	322	14,0	
41128/126*	26mm	09317 9	6	2,71	400 x 120 x 65mm	8,7	337	14,5	
41128/127*	27mm	09318 6	6	3,14	420 x 150 x 95mm	9,2	352	14,5	
41128/128*	28mm	09319 3	6	3,39	420 x 150 x 95mm	9,6	370	15,0	
41128/130*	30mm	09320 9	6	3,78	430 x 90 x 120mm	10,0	390	15,0	
41128/132*	32mm	09321 6	6	4,21	430 x 90 x 120mm	10,4	412	16,0	

Corpo forjado em aço carbono e temperado.
Acabamento cromado.
Abertura das bocas calibradas. Pescoço curto.

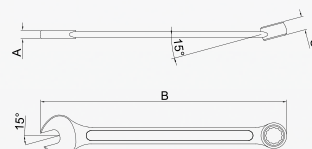

IPI 8% incluso - NCM: 8204.11.00

Forged and hardened carbon steel body.
Chrome plated finishing.
Calibrated openings.
Short neck.

*Cuerpo forjado en acero carbono templado.
Acabado cromado.
Apertura de las bocas calibradas.*



41128 Jogo de Chaves Combinadas - Basic - Milímetros Combination Wrench Set - Basic - Millimeters Juego de Llaves Combinadas - Basic Milímetros

REF.	Peças Pieces Piezas	EAN 789.1114	Embalagem Package Embalaje		
			Un.	KG	Comp x larg x alt Length x width x height Largo x ancho x altura
41128/205	5	07188 7	1	0,38	220 x 90 x 45mm
			6	2,42	255 x 240 x 110mm
41128/208	8	07187 0	1	0,77	260 x 90 x 60mm
			6	4,93	285 x 320 x 120mm
41128/212*	12	09423 7	1	1,21	290 x 80 x 60mm
			6	7,47	300 x 250 x 145mm
41128/215*	15	09422 0	1	3,37	410 x 110 x 90mm
			6	20,60	435 x 360 x 190mm
41128/217*	17	09424 4	1	2,11	310 x 105 x 60mm
			6	13,03	350 x 340 x 140mm

Composição | Set includes | Composición:

41128/205: 10, 11, 12, 13, 14mm.

41128/208: 10, 11, 12, 13, 14, 15, 17, 19mm.

41128/212: 6, 7, 8, 9, 10, 11, 12, 13, 14, 17, 19, 22mm.

41128/215: 6, 7, 8, 10, 11, 12, 13, 14, 17, 19, 22, 24, 27, 30, 32mm.

41128/217: 6, 7, 8, 9, 10, 11, 12, 13, 14, 15, 16, 17, 18, 19, 20, 21, 22mm.

• Embalagem plástica de enrolar | Plastic roll pouch | *embalaje plástica*.



IPI 8% incluso - NCM: 8204.11.00

41016 Chave Ajustável * Adjustable Wrench Llave Ajustable

REF.	Tamanho Size <i>Tamaño</i>	EAN 789.1114	Embalagem Package Embalaje			Dimensões Dimensions (mm)				
			Un.	KG	Comp x larg x alt Length x width x height Largo x ancho x altura	A	B	C	D	
BLISTER CLAM PACK 										
41016/506	6"	06829 0	6	0,91	270 x 125 x 80mm	45	155	19,5	5,5	11
			24	3,42	350 x 175 x 90mm					
41016/508	8"	06830 6	6	1,66	275 x 120 x 80mm	57,5	205	24,5	7	13
			24	6,53	370 x 195 x 100mm					
41016/510	10"	06271 7	6	2,80	350 x 175 x 90mm	67	255	28	8	16
			24	10,99	445 x 280 x 140mm					
41016/512	12"	06272 4	6	4,12	400 x 140 x 90mm	77	305	33	10	18,5
			24	15,94	440 x 285 x 145mm					

Corpo em aço carbono especial forjado e temperado.

Acabamento cromado.

Escala marcada a laser.

IPI 8% incluso - NCM: 8204.12.00

Forged and hardened carbon steel body.

Chrome plated finishing.

Laser marked scale.

Forjada y templada en acero carbono.

Acabado cromado.

Escala marcada con laser.

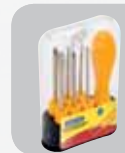
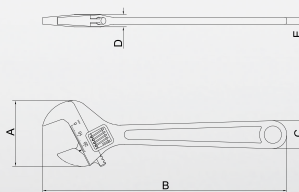



42805 Chave Biela - Milímetros
Hollow Offset Pipe Wrench - Millimeters
Llave de Pipa Abierta - Milímetros

REF.	Tamanho Size Tamaño	EAN 789.1114	Embalagem Package Embalaje			Dimensões Dimensions (mm)				
			Un.	KG	Comp x larg x alt Length x width x height Largo x ancho x altura	A	B	C	D	
SUPORTE PLÁSTICO PLASTIC HANGER SOPORTE PLÁSTICO 										
42805/108	8mm	02964 2	6	1,33	400 x 120 x 60mm	82	220	14,3	13,5	10
42805/109	9mm	02965 9	6	1,36	400 x 120 x 60mm	82	220	15,4	14,5	10
42805/110	10mm	02966 6	6	1,40	400 x 120 x 60mm	82	220	16,5	15,5	10
42805/111	11mm	02967 3	6	1,43	365 x 125 x 80mm	85	220	18,1	16,5	10
42805/112	12mm	02968 0	6	2,15	365 x 125 x 80mm	85	235	19,2	17,5	12,7
42805/113	13mm	02969 7	6	2,23	390 x 140 x 85mm	85	235	20,8	19	12,7
42805/114	14mm	02970 3	6	2,46	390 x 140 x 85mm	90	250	21,8	20	12,7
42805/115	15mm	02971 0	6	2,45	390 x 140 x 85mm	90	250	22,9	21,5	12,7
42805/116	16mm	02972 7	6	2,63	390 x 140 x 85mm	90	250	25	23	12,7
42805/117	17mm	02973 4	6	2,77	390 x 140 x 85mm	90	250	26,6	24,5	14,28
42805/118	18mm	02974 1	6	3,22	390 x 140 x 85mm	90	250	27,6	25,5	14,28
42805/119	19mm	02975 8	6	3,22	350 x 175 x 90mm	90	250	29,1	26,5	14,28

Corpo forjado em aço carbono e temperado.
Acabamento cromado.
Abertura das bocas calibradas.

IPI 8% incluso - NCM: 8204.11.00

Forged and hardened carbon steel body.
Chrome plated finishing.
Calibrated openings.

*Cuerpo forjado en acero carbono templado.
Acabado cromado.
Apertura de las bocas calibradas.*

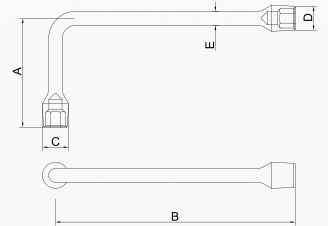

42806 Chave Biela - Polegadas
Hollow Offset Pipe Wrench - Inches
Llave de Pipa Abierta - Pulgadas

REF.	Tamanho Size Tamaño	EAN 789.1114	Embalagem Package Embalaje			Dimensões Dimensions (mm)				
			Un.	KG	Comp x larg x alt Length x width x height Largo x ancho x altura	A	B	C	D	
SUPORTE PLÁSTICO PLASTIC HANGER SOPORTE PLÁSTICO 										
42806/100	3/8"	06384 4	6	1,25	365 x 125 x 80mm	82	220	16,5	15,5	10
42806/101	7/16"	06385 1	6	1,96	400 x 120 x 60mm	85	220	18,1	16,5	10
42806/102	1/2"	06386 8	6	1,97	365 x 125 x 80mm	85	235	20,8	19	12,7
42806/103	9/16"	06387 5	6	2,40	365 x 125 x 80mm	90	250	22,9	21,5	12,7
42806/104	5/8"	06388 2	6	2,30	365 x 125 x 80mm	90	250	25	23	12,7
42806/105	11/16"	06389 9	6	2,94	365 x 125 x 80mm	90	250	27,6	25,5	14,28
42806/106	3/4"	06390 5	6	2,59	350 x 175 x 90mm	90	250	29,1	26,5	14,28

Corpo forjado em aço carbono e temperado.
Acabamento cromado.
Abertura das bocas calibradas.

IPI 8% incluso - NCM: 8204.11.00

Forged and hardened carbon steel body.
Chrome plated finishing.
Calibrated openings.

*Cuerpo forjado en acero carbono templado.
Acabado cromado.
Apertura de las bocas calibradas.*

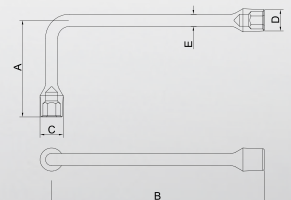

42810 Chave de Roda para Caminhão - Milímetros
Wheel Nut Wrench - Millimeters
Llave de Rueda para Camión - Milímetros

42811 Manípulo
Bar
Barra

REF.	Tamanho Size <i>Tamaño</i>	EAN 789.1114	Embalagem Package <i>Embalaje</i>			Dimensões Dimensions (mm)			
			Un.	KG	Comp x larg x alt Length x width x height <i>Largo x ancho x altura</i>	A	B	C	D
42810/001	24x27mm	04592 5	6	8,75	420 x 165 x 120mm	38	400	42	
42810/002	27x30mm	04593 2	6	11,44	420 x 165 x 120mm	42	400	46	
42810/003	32x30mm	04594 9	6	11,44	420 x 165 x 120mm	46	400	48	
42810/004	32x33mm	04595 6	6	12,07	420 x 165 x 120mm	48	400	50	
42810/005	27x32mm	04596 3	6	11,35	420 x 165 x 120mm	42	400	48	
42810/006	27x33mm	04597 0	6	11,46	420 x 165 x 120mm	42	400	50	
42810/007	41x21mm*	04925 1	6	15,14	420 x 165 x 120mm	44	400	60	
42810/008	38x21mm*	04926 8	6	13,76	420 x 165 x 120mm	44	400	53	
42811/001	500mm	04598 7	6	6,68	580 x 95 x 80mm	19,05	500		

Chave de roda:

Corpo forjado em aço carbono e temperado.
Acabamento cromado.
Abertura das bocas calibradas.

*42810/007 e 42810/008: a extremidade de 21mm possui formato quadrado.

Manípulo:

Corpo forjado em aço carbono e temperado.
Acabamento cromado.

IPI 8% incluso - NCM: 8204.11.00

Wheel Nut Wrench:

Forged and hardened carbon steel body.
Chrome plated finishing.
Calibrated openings.

*The 38mm and 41mm end have six point socket. The other end is 21mm with square shape.

Bar:

Forged and hardened carbon steel body.
Chrome plated finishing.

Llave de Rueda para Camión:

*Cuerpo forjado en acero carbono templado.
Acabado cromado.
Apertura de las bocas calibradas.*

** Las extremidades con 38mm y 41mm son sextavadas. La otra extremidad es de 21mm y tiene un formato cuadrado.*

Barra:

*Cuerpo forjado en acero carbono templado.
Acabado cromado.*

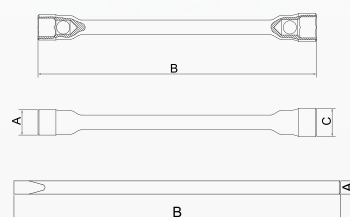

42810

42811

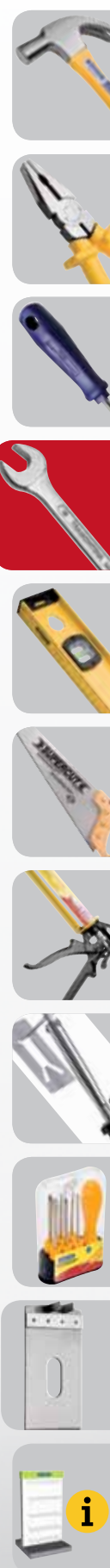



42830 Chave de Roda tipo "L" - Milímetros
"L" Type Wrench - Millimeters
Llave en "L" para Rueda - Milímetros

REF.	Tamanho Size Tamaño	EAN 789.1114	Embalagem Package Embalaje			Dimensões Dimensions (mm)			
			Un.	KG	Comp x larg x alt Length x width x height Largo x ancho x altura	A	B	C	D
SOPORTE PLÁSTICO PLASTIC HANGER SOPORTE PLÁSTICO									
42830/117	17mm	02976 5	6	2,29	365 x 125 x 80mm	175	220	12,7	26
42830/119	19mm	02977 2	6	2,30	365 x 125 x 80mm	175	220	12,7	28
42830/121	21mm	06547 3	6	3,19	420 x 140 x 95mm	110	320	18	33
42830/124	24mm	06383 7	6	4,40	420 x 140 x 95mm	110	360	18	38

Corpo forjado em aço carbono e temperado.
Acabamento cromado.
Abertura das bocas calibradas.

IPI 8% incluso - NCM: 8204.11.00

Forged and hardened carbon steel body.
Chrome plated finishing.
Calibrated openings.

*Cuerpo forjado en acero carbono templado.
Acabado cromado.
Apertura de las bocas calibradas.*

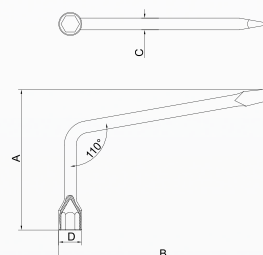

42860 Chave de Roda tipo "Cruz"
4 Way Cross Wrench with Chisel
Llave en Cruz con Espátula

REF.	Tamanho Size Tamaño	EAN 789.1114	Embalagem Package Embalaje			Dimensões Dimensions (mm)					
			Un.	Peso	Comp x larg x alt	A	B	C	D	E	F
42860/001	17-19-21mm + espátula	01595 9	6	7,06	285 x 320 x 120mm	27,2	500	29,2	31,7	16	16



Corpo forjado em aço carbono e temperado.
Acabamento cromado.
Abertura das bocas calibradas.

IPI 8% incluso - NCM: 8204.11.00

Forged and hardened carbon steel body.
Chrome plated finishing.
Calibrated openings.

*Cuerpo forjado en acero carbono templado.
Acabado cromado.
Apertura de las bocas calibradas.*

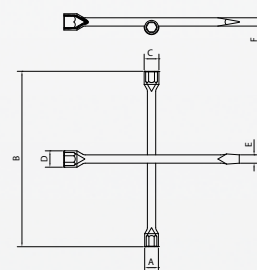

42860 Chave de Roda tipo "Cruz"
4 Way Cross Wrench
Llave en Cruz

REF.	Tamanho Size Tamaño	EAN 789.1114	Embalagem Package Embalaje			Dimensões Dimensions (mm)					
			Un.	Peso	Comp x larg x alt	A	B	C	D	E	F
42860/002	3/4" e 13/16" - 17mm e 23mm	05260 2	6	10,16	400 x 400 x 130mm	29,2	500	31,7	34,5	27,2	16

Corpo forjado em aço carbono e temperado.
Acabamento cromado.
Abertura das bocas calibradas.

IPI 8% incluso - NCM: 8204.11.00

Forged and hardened carbon steel body.
Chrome plated finishing.
Calibrated openings.

*Cuerpo forjado en acero carbono templado.
Acabado cromado.
Apertura de las bocas calibradas.*

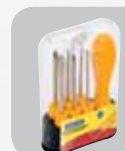
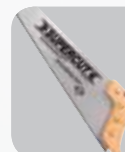
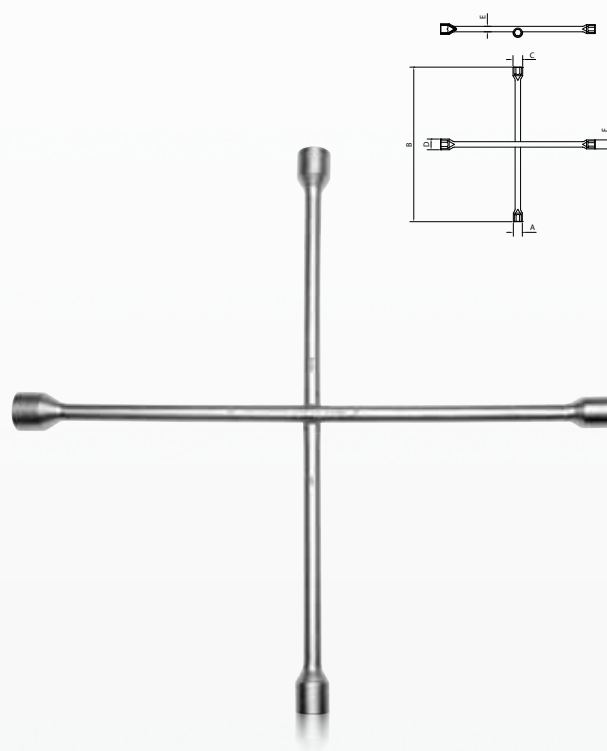



FERRAMENTAS DE MEDIÇÃO
MEASURING TOOLS
HERRAMIENTAS DE MEDICIÓN





43100 Nível de Alumínio Aluminum Level Nivel de Aluminio

REF.	Tamanho Size <i>Tamaño</i>	EAN 789.1114	Embalagem Package <i>Embalaje</i>		Dimensões Dimensions (mm)				
			Un.	KG	Comp x larg x alt Length x width x height <i>Largo x ancho x altura</i>	A	B	C	D
43100/012	300mm (12")	01333 7	1	0,10	300 x 60 x 25mm	53	300	23	1,2
			12	1,44	380 x 160 x 120mm				
43100/014	350mm (14")	01344 3	1	0,13	350 x 60 x 25mm	53	350	23	1,2
			12	1,73	380 x 160 x 120mm				
43100/018	450mm (18")	01345 0	1	0,25	450 x 60 x 25mm	53	450	23	1,2
			12	3,19	480 x 160 x 120mm				
43100/024	600mm (24")	01346 7	1	0,22	610 x 60 x 25mm	53	610	23	1,2
			12	2,91	630 x 160 x 120mm				

Ampolas de 360° que permitem leitura acurada.
Estrutura super resistente em perfil "I" de 23x53mm.
Níveis de 12" e 14" com duas ampolas (0° e 90°).
Níveis de 18" e 24" com três ampolas (0°, 45° e 90°).

IPI 5% incluso - NCM: 9031.80.99

Calibrated readings 360° vials.
High resistance structure in "I" profile, size 23x53mm.
12" and 14" levels with two vials (0° and 90°).
18" and 24" levels with three vials (0°, 45° and 90°).

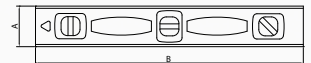

Veja bolhas avulsas na pág. 166.
Check spare vials on the page 166.
Veá burbujas sueltas en la página 166.

*Ampollas de 360° permiten lectura perfeccionada.
Estructura súper resistente en viga "I" de 23x53mm.
Niveles 12" y 14" con dos ampollas (0° y 90°).
Niveles 18" y 24" con tres ampollas (0°, 45° y 90°).*



43110 Nível Magnético de Alumínio * Magnetic Level Nivel Magnético

REF.	Tamanho Size <i>Tamaño</i>	EAN 789.1114	Embalagem Package <i>Embalaje</i>		Dimensões Dimensions (mm)			
			Un.	KG	Comp x larg x alt Length x width x height <i>Largo x ancho x altura</i>	A	B	C
43110/012	12"	08347 7	1	0,27	305 x 25 x 65mm	60	305	25
			12	3,18	332 x 208 x 115mm			
43110/018	18"	44929 7	1	0,41	460 x 25 x 60mm	60	455	25
			12	5,08	460 x 155 x 160mm			

Ampolas de 360° que permitem leitura acurada.
Estrutura super resistente de alumínio em perfil "I" de 26x60mm.
Visores em policarbonato transparente para proteção das bolhas.
Base magnética em forma de fita com a função de fixação em superfícies metálicas.
Régua graduada na parte superior do produto.
Proteção plástica nas extremidades.

43110/012 - com duas ampolas (0° e 90°).
43110/018 - com três ampolas (0°, 45° e 90°).

IPI 5% incluso - NCM: 9031.80.99

Calibrated readings 360° vials.
High resistance aluminum structure in "I" profile, size 26x60mm.
Protective polycarbonate vials cover.
Magnetic base which provides better fixation to metallic surfaces.
Graduated rule on the top.
Plastic protection at both edges.

43110/012 - with two vials (0° and 90°).
43110/018 - with three vials (0°, 45° and 90°).

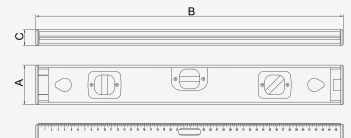

Veja bolhas avulsas na pág. 166.
Check spare vials on the page 166.
Veá burbujas sueltas en la página 166.

*Ampollas de 360° permiten lectura perfeccionada.
Estructura de aluminio super resistente en viga "I" de 26x60mm.
Lentes de policarbonato para protección de las burbujas.
Base magnética que facilita la fijación en superficies metálicas.
Regla graduada en la parte superior.
Protección plástica en las extremidades.*

43110/012 - con dos ampollas (0° y 90°).
43110/018 - con tres ampollas (0°, 45° y 90°).

43120 Nível de Alumínio Anodizado Aluminum Level Nível de Alumínio

REF.	Tamanho Size <i>Tamaño</i>	EAN 789.1114	Embalagem Package <i>Embalaje</i>			Dimensões Dimensions (mm)			
			Un.	KG	Comp x larg x alt Length x width x height <i>Largo x ancho x altura</i>	A	B	C	D
43120/012	300mm (12")	00041 2	1	0,18	310 x 60 x 25mm	53	300	23	2
			12	2,39	380 x 160 x 120mm				
43120/014	350mm (14")	00042 9	1	0,24	360 x 60 x 25mm	53	350	23	2
			12	3,05	380 x 160 x 120mm				
43120/018	450mm (18")	00043 6	1	0,29	460 x 60 x 25mm	53	450	23	2
			12	3,74	480 x 160 x 120mm				
43120/024	600mm (24")	00044 3	1	0,36	620 x 60 x 25mm	53	610	23	2
			12	4,67	630 x 160 x 120mm				

Ampolas de 360° que permitem leitura acurada.
Estrutura super resistente anodizada e em perfil "I" de 23x53mm.
Proteção plástica nas extremidades.
Visores em policarbonato transparente para proteção das bolhas.
Níveis de 12" e 14" com duas ampolas (0° e 90°).
Níveis de 18" e 24" com três ampolas (0°, 45° e 90°).

IPI 5% incluso - NCM: 9031.80.99

Calibrated readings 360° vials.
High resistance structure in "I" profile, size 23x53mm.
Plastic protection at both sides.
12" and 14" levels with two vials (0° and 90°).
18" and 24" levels with three vials (0°, 45° and 90°).



Veja bolhas avulsas na pág. 166.
Check spare vials on the page 166.
Vea burbujas sueltas en la página 166.

*Ampollas de 360° permiten lectura perfeccionada.
Estructura súper resistente en viga "I" de 23x53mm.
Protección plástica en las extremidades.
Niveles 12" y 14" con dos ampollas (0° y 90°).
Niveles 18" y 24" con tres ampollas (0°, 45° y 90°).*

43140 Nível Plástico Plastic Level Nível de Plástico

REF.	Tamanho Size <i>Tamaño</i>	EAN 789.1114	Embalagem Package <i>Embalaje</i>			Dimensões Dimensions (mm)		
			Un.	KG	Comp x larg x alt Length x width x height <i>Largo x ancho x altura</i>	A	B	C
43140/000	230mm	02729 7	12	0,73	305 x 135 x 70mm	43	230	15

Ampola de 360° que permite leitura acurada.
Corpo injetado em ABS.
Bolha removível - 3 posições (0°, 45° e 90°).

IPI 5% incluso - NCM: 9031.80.99

Calibrated reading 360° vial.
Injected ABS body.
Removable vial – 3 different positions (0°, 45° and 90°).

*Ampolla de 360° que permite lectura perfeccionada.
Cuerpo inyectado en ABS.
Nivel con ampolla móvil – 3 posiciones diferentes (0°, 45° y 90°).*

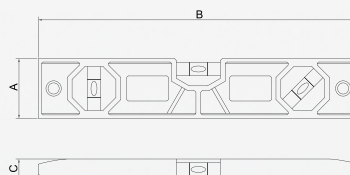

Veja bolhas avulsas na pág. 166.
Check spare vials on the page 166.
Vea burbujas sueltas en la página 166.

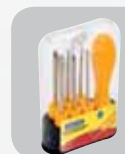



43155 Trena
* **Measuring Tape**
Cinta Métrica

REF.	Tamanho Size <i>Tamaño</i>	EAN 789.1114	Embalagem Package <i>Embalaje</i>			Dimensões Dimensions (mm)		
			Un.	KG	Comp x larg x alt Length x width x height <i>Largo x ancho x altura</i>	A	B	C
BLISTER CLAM PACK 								
43155/310	10m	05167 4	12	2,26	210 x 175 x 130mm	75	85	23
			36	7,24	410 x 220 x 190mm			
43155/320	20m	05168 1	12	3,84	245 x 175 x 150mm	90	105	24
			36	12,22	475 x 265 x 190mm			
43155/330	30m	05169 8	6	2,81	270 x 95 x 190mm	107	122	25
			36	17,53	580 x 290 x 210mm			

Fita em aço temperado.
Graduação em milímetros e polegadas.
Corpo em plástico ABS.
Manivela para retorno da fita.

IPI 15% incluso - NCM: 9017.80.90

Hardened steel measure tape.
Millimeter and inch scale.
ABS plastic body.
Swivel knob mechanism to return the tape.

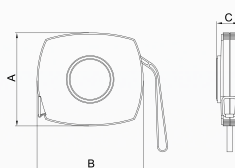

*Cinta en acero templado.
Graduación en milímetros y pulgadas.
Cuerpo plástico en ABS.
Manija para retorno de la cinta.*



43156 Trena
* **Measuring Tape**
Cinta Métrica

REF.	Tamanho Size <i>Tamaño</i>	EAN 789.1114	Embalagem Package <i>Embalaje</i>			Dimensões Dimensions (mm)		
			Un.	KG	Comp x larg x alt Length x width x height <i>Largo x ancho x altura</i>	A	B	C
BLISTER CLAM PACK 								
43156/303	3m x 16mm	08023 0	12	1,45	250 x 155 x 95mm	59	64	31,5
			60	7,75	480 x 265 x 180mm			
43156/305	5m x 19mm	08024 7	12	2,44	260 x 175 x 115mm	68	73,5	35
			60	12,72	580 x 285 x 195mm			
43156/375	7,5m x 25mm	08025 4	12	4,30	300 x 180 x 110mm	76	82,5	41
			60	22,00	570 x 320 x 200mm			
43156/310	10m x 25mm	09167 0	12	4,80	285 x 215 x 125mm	87	95	41
			60	25,00	650 x 295 x 220mm			

Fita em aço temperado. Corpo em plástico ABS.
Graduação em milímetros e polegadas.
Trava para fixar a fita métrica.
Cinta para facilitar o transporte. Freio duplo.
Fita com 3 rebites para maior segurança.

IPI 15% incluso - NCM: 9017.80.90

Hardened steel measure tape. ABS plastic body.
Millimeter and inch scale.
Lock system for the tape.
String belt for better handling. Double lock system.
3 rivets on the tape for safety.

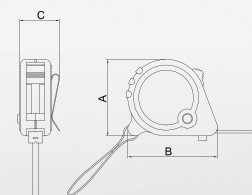

*Cinta en acero templado. Cuerpo plástico en ABS.
Graduación en milímetros y pulgadas.
Traba para fijar la cinta métrica.
Cordel para facilitar el transporte. Freno doble.
Cinta con 3 remaches para mayor seguridad.*

43171 Esquadro
* Square
Escuadra

REF.	Tamanho Size <i>Tamaño</i>	EAN 789.1114	Embalagem Package <i>Embalaje</i>			Dimensões Dimensions (mm)		
			Un.	KG	Comp x larg x alt Length x width x height <i>Largo x ancho x altura</i>	A	B	C
43171/010	10"	04776 9	12	2,44	320 x 190 x 100mm	159,3	260	12
43171/012	12"	04777 6	12	2,56	320 x 190 x 100mm	159,3	310	12

Cabo e corpo em alumínio.
Gradação em milímetros e polegadas.

IPI 15% incluso - NCM: 9017.20.00

Aluminum body and handle.
Millimeter and inch scale.

Cuerpo y mango en aluminio.
Graduación en milímetros y pulgadas.

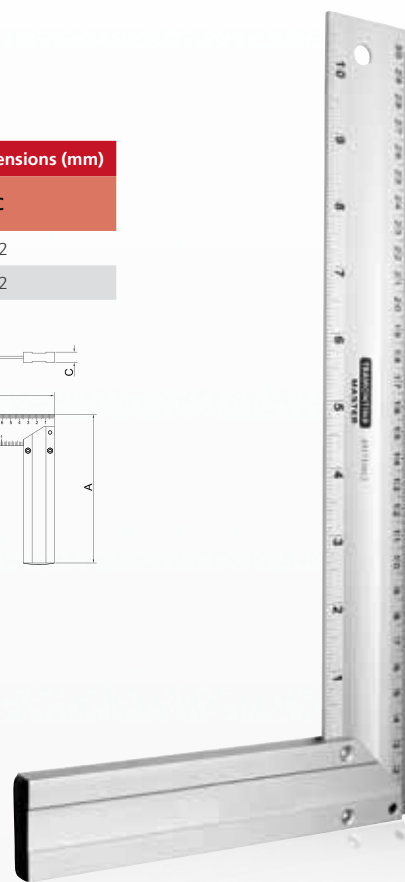
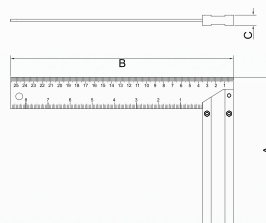

43170 Esquadro
Square
Escuadra

REF.	Tamanho Size <i>Tamaño</i>	EAN 789.1114	Embalagem Package <i>Embalaje</i>			Dimensões Dimensions (mm)		
			Un.	KG	Comp x larg x alt Length x width x height <i>Largo x ancho x altura</i>	A	B	C
43170/010	25cm	01338 2	12	1,05	320 x 190 x 100mm	145	294	14
43170/012	30cm	01339 9	12	1,18	380 x 160 x 120mm	145	344,8	14

Corpo em aço carbono temperado.
Cabo injetado.
Gradação em milímetros e polegadas.

IPI 15% incluso - NCM: 9017.20.00

Hardened carbon steel body.
Injected handle.
Millimeter and inch scale.

Cuerpo en acero carbono templado.
Mango inyectado.
Graduación en milímetros y pulgadas.

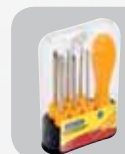
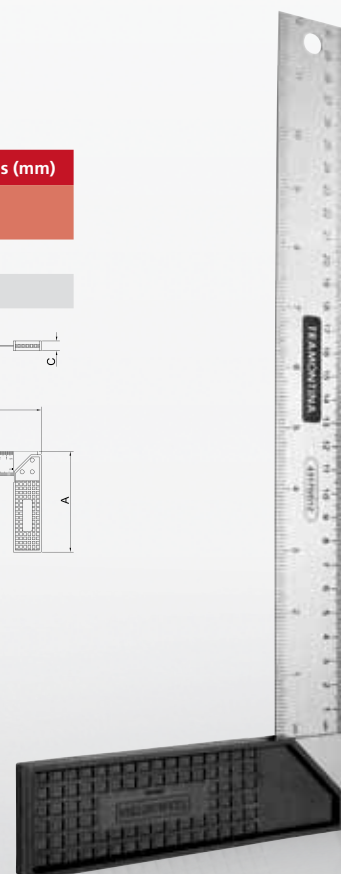
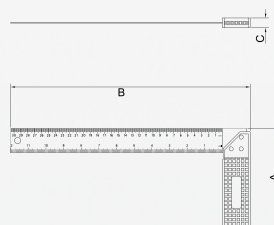



43180 Prumo
Plumb
Plomada

REF.	Peso Weight	EAN 789.1114	Embalagem Package Embalaje			Dimensões Dimensions (mm)			
			Un.	KG	Comp x larg x alt Length x width x height Largo x ancho x altura	A	B	C	D
43180/001	500g	01340 5	12	6,17	280 x 170 x 95mm	45	76	45	76
BLISTER CLAM PACK 									
43180/501	500g	01343 6	12	6,39	335 x 210 x 115mm	45	76	45	76

Corpo em aço revestido por plástico.
Calço guia de madeira.
Cordão de náilon.

IPI 5% incluso - NCM: 9031.80.99

Steel body covered in plastic material.
Hardwood guide.
Nylon string.

Cuerpo en acero revestido en plástico.
Guía de madera.
Cordón de nailon.

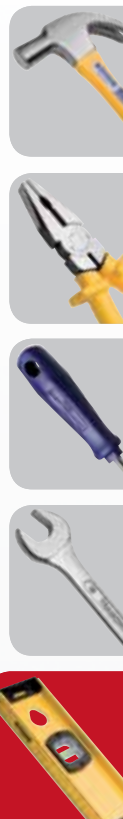
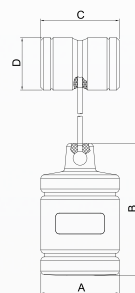

43181 Prumo de Centro
* **Pointed Plumb Bob**
Plomada de Punta

REF.	Peso Weight	EAN 789.1114	Embalagem Package Embalaje			Dimensões Dimensions (mm)			
			Un.	KG	Comp x larg x alt Length x width x height Largo x ancho x altura	A	B	C	D
BLISTER CLAM PACK 									
43181/501	400g	07811 4	12	5,32	420 x 165 x 120mm	47	79	47	

Corpo em aço.
Calço guia de aço.
Cordão de náilon.

IPI 5% incluso - NCM: 9031.80.99

Steel body.
Steel guide.
Nylon string.

Cuerpo en acero.
Guía en acero.
Cordón de nailon.

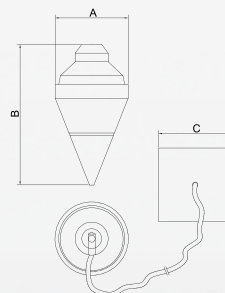

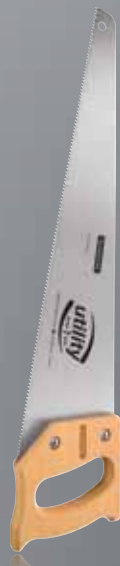

FERRAMENTAS DE CORTE, DESBASTE E AFIAÇÃO

CUTTING, THINNING AND SHARPENING
TOOLS

HERRAMIENTAS DE CORTE, DESBASTE Y
AFILACIÓN





43240 Serrote Profissional - 7 Dentes por polegadas
Professional Saw - 7 Teeth per inch
Serrucho Profesional - 7 Dientes por pulgadas

REF.	Tamanho Size <i>Tamaño</i>	EAN 789.1114	Embalagem Package <i>Embalaje</i>			Dimensões Dimensions (mm)		
			Un.	KG	Comp x larg x alt Length x width x height <i>Largo x ancho x altura</i>	A	B	C
43240/016	16"	01480 8	6	3,40	565 x 100 x 160mm	146	486,9	22
43240/018	18"	00027 6	6	3,28	565 x 100 x 160mm	146	534,9	22
43240/020	20"	00028 3	6	3,70	610 x 100 x 160mm	146	582,3	22
43240/022	22"	00029 0	6	4,19	650 x 95 x 180mm	146	629,3	22
43240/024	24"	00037 5	6	4,58	710 x 95 x 180mm	146	677,3	22
43240/026	26"	00121 1	6	4,63	760 x 105 x 170mm	146	724	22

Lâmina em aço alto carbono temperado e lixado.
Cabo de madeira ergonômico e envernizado.
Dentes travados.
Proteção plástica para os dentes.

PI 8% incluso - NCM: 8202.10.00

Hardened and polished high carbon steel blade.
Ergonomic and varnished hardwood handle.
Set teeth.
Plastic protection for the cutting area.

Lámina en acero alto carbono templado y lijado.
Mango de madera ergonômico barnizado.
Dientes trabados.
Protección plástica en el área de corte.

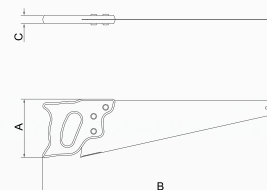

43242 Serrote Profissional - 5 Dentes por polegadas
Professional Saw - 5 Teeth per inch
Serrucho Profesional - 5 Dientes por pulgadas

REF.	Tamanho Size <i>Tamaño</i>	EAN 789.1114	Embalagem Package <i>Embalaje</i>			Dimensões Dimensions (mm)		
			Un.	KG	Comp x larg x alt Length x width x height <i>Largo x ancho x altura</i>	A	B	C
43242/016	16"	01725 0	6	3,13	565 x 100 x 160mm	146	486,9	22
43242/018	18"	00353 6	6	3,34	565 x 100 x 160mm	146	534,6	22
43242/020	20"	00354 3	6	3,61	610 x 100 x 160mm	146	582,3	22
43242/022	22"	00355 0	6	4,37	650 x 95 x 180mm	146	629,2	22
43242/024	24"	00356 7	6	4,70	710 x 95 x 180mm	146	677,3	22
43242/026	26"	00357 4	6	4,81	760 x 105 x 170mm	146	724	22

Lâmina em aço alto carbono temperado e lixado.
Cabo de madeira ergonômico e envernizado.
Dentes travados.
Proteção plástica para os dentes.

IPI 8% incluso - NCM: 8202.10.00

Hardened and polished high carbon steel blade.
Ergonomic and varnished hardwood handle.
Set teeth.
Plastic protection for the cutting area.

Lámina en acero alto carbono templado y lijado.
Mango de madera ergonômico barnizado.
Dientes trabados.
Protección plástica en el área de corte.

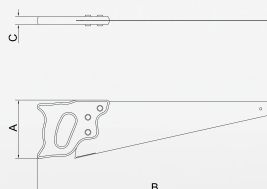

43244 Serrote Profissional - SUPERCUT - 7 Dentes por polegadas
Professional Saw - SUPERCUT - 7 Teeth per inch
Serrucho Profesional - SUPERCUT - 7 Dientes por pulgadas

REF.	Tamanho Size <i>Tamaño</i>	EAN 789.1114	Embalagem Package <i>Embalaje</i>			Dimensões Dimensions (mm)		
			Un.	KG	Comp x larg x alt Length x width x height <i>Largo x ancho x altura</i>	A	B	C
43244/015	15"	07589 2	6	2,73	565 x 100 x 160mm	149	475	31
43244/018	18"	09159 5	6	3,28	565 x 100 x 160mm	149	550	31
43244/020	20"	09160 1	6	3,70	610 x 100 x 160mm	149	600	31
43244/022	22"	09161 8	6	4,14	650 x 95 x 180mm	149	650	31

Lâmina em aço alto carbono temperado e lixado.
Gravação em centímetros na barra superior da lâmina.
Cabo em dupla injeção ergonômico.
Dentes travados, com tripla afiação e com têmpera por indução.
Proteção plástica para os dentes.

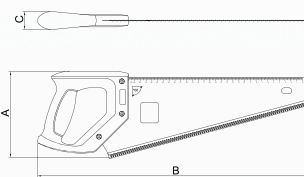

IPI 8% incluso - NCM: 8202.10.00

Hardened and polished high carbon steel blade.
Ergonomic and double injected handle.
Aggressive and induction hardened set teeth.
Plastic protection for the cutting area.



Dentes com têmpera por indução.
Induction hardened teeth.
Dientes templados por inducción.

Lâmina em aço alto carbono templado y lijado.
Mango ergonómico con doble inyección.
Dientes trabados, con triple filo y templados por inducción.
Protección plástica en el área de corte.



Dentes com tripla afiação.
Aggressive teeth.
Dientes con triple afilado.

43245 Serrote Profissional - SUPERCUT - 7 Dentes por polegadas
Professional Saw - SUPERCUT - 7 Teeth per inch
Serrucho Profesional - SUPERCUT - 7 Dientes por pulgadas

REF.	Tamanho Size <i>Tamaño</i>	EAN 789.1114	Embalagem Package <i>Embalaje</i>			Dimensões Dimensions (mm)		
			Un.	KG	Comp x larg x alt Length x width x height <i>Largo x ancho x altura</i>	A	B	C
43245/018	18"	07750 6	6	4,19	650 x 95 x 180mm	160	560	23
43245/020	20"	07738 4	6	4,35	650 x 95 x 180mm	160	610	23
43245/022	22"	05845 1	6	4,74	710 x 95 x 180mm	160	628	23
43245/024	24"	05846 8	6	4,90	710 x 95 x 180mm	160	679	23
43245/026	26"	05847 5	6	5,10	760 x 105 x 170mm	160	732	23

Lâmina em aço alto carbono temperado e lixado.
Cabo de madeira ergonômico e envernizado.
Dentes travados, com tripla afiação e com têmpera por indução.
Proteção plástica para os dentes.

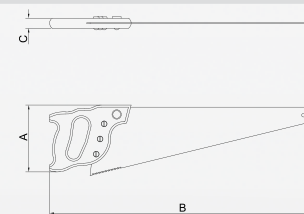

IPI 8% incluso - NCM: 8202.10.00

Hardened and polished high carbon steel blade.
Ergonomic and varnished hardwood handle.
Aggressive and induction hardened set teeth.
Plastic protection for the cutting area.

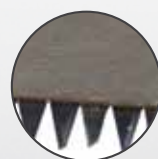

Dentes com têmpera por indução.
Induction hardened teeth.
Dientes templados por inducción.

Lâmina em aço alto carbono templado y lijado.
Mango de madera ergonómico barnizado.
Dientes trabados, con triple filo y templados por inducción.
Protección plástica en el área de corte.



Dentes com tripla afiação.
Aggressive teeth.
Dientes con triple afilado.

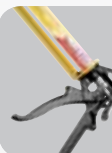
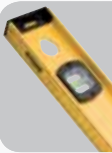
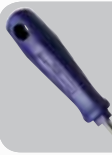



43200 Serrote Utility - Basic - 7 Dentes por polegadas
Utility Saw - Basic - 7 Teeth per inch
Serrucho Utility - Basic - 7 Dientes por pulgadas

REF.	Tamanho Size <i>Tamaño</i>	EAN 789.1114	Embalagem Package <i>Embalaje</i>			Dimensões Dimensions (mm)		
			Un.	KG	Comp x larg x alt Length x width x height <i>Largo x ancho x altura</i>	A	B	C
43200/016	16"	00486 1	6	2,52	550 x 95 x 150mm	127	460	21
43200/018	18"	00117 4	6	2,81	550 x 95 x 150mm	127	515	21
43200/020	20"	00118 1	6	2,94	610 x 100 x 160mm	127	565	21
43200/022	22"	00119 8	6	2,94	655 x 95 x 150mm	127	615	21

Lâmina em aço carbono temperado e lixado.
Cabo de madeira envernizado.
Dentes travados.
Proteção plástica para os dentes.

IPI 8% incluso - NCM: 8202.10.00

Hardened and polished carbon steel blade.
Varnished hardwood handle.
Set teeth.
Plastic protection for the cutting area.

Lámina en acero carbono templado y lijado.
Mango de madera barnizado.
Dientes trabados.
Protección plástica en el área de corte.

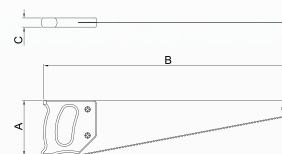

43204 Serrote Utility - Basic - 7 Dentes por polegadas
Utility Saw - Basic - 7 Teeth per inch
Serrucho Utility - Basic - 7 Dientes por pulgadas

REF.	Tamanho Size <i>Tamaño</i>	EAN 789.1114	Embalagem Package <i>Embalaje</i>			Dimensões Dimensions (mm)		
			Un.	KG	Comp x larg x alt Length x width x height <i>Largo x ancho x altura</i>	A	B	C
43204/016	16"	00487 8	6	1,96	550 x 95 x 150mm	123	460	22
43204/018	18"	00122 8	6	2,14	550 x 95 x 150mm	123	515	22
43204/020	20"	00123 5	6	2,41	610 x 100 x 160mm	123	565	22
43204/022	22"	00124 2	6	2,52	655 x 95 x 150mm	123	615	22

Lâmina em aço carbono temperado e lixado.
Cabo de plástico.
Dentes travados.
Proteção plástica para os dentes.

IPI 8% incluso - NCM: 8202.10.00

Hardened and polished carbon steel blade.
Injected handle.
Set teeth.
Plastic protection for the cutting area.

Lámina en acero carbono templado y lijado.
Mango inyectado.
Dientes trabados.
Protección plástica en el área de corte.

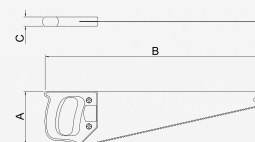

43280 Serrote de Ponta - 7 Dentes por polegadas
Compass Saw - 7 Teeth per inch
Serrucho de Ponta - 7 Dientes por pulgadas

REF.	Tamanho Size Tamaño	EAN 789.1114	Embalagem Package Embalaje			Dimensões Dimensions (mm)		
			Un.	KG	Comp x larg x alt Length x width x height Largo x ancho x altura	A	B	C
43280/012	12"	01027 5	6	1,56	500 x 100 x 150mm	127	450	22

Lâmina em aço alto carbono temperado e lixado.
Cabo de madeira ergonômico e envernizado.
Dentes travados.
Proteção plástica para os dentes.

IPI 8% incluso - NCM: 8202.10.00

Hardened and polished carbon steel blade.
Ergonomic and varnished hardwood handle.
Set teeth.
Plastic protection for the cutting area.

Lámina en acero carbono templado y lijado.
Mango de madera ergonómico barnizado.
Dientes trabados.
Protección plástica en el área de corte.

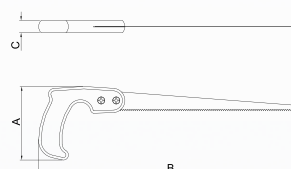

43285 Serrote Costa - 12 Dentes por polegadas
Back Saw - 12 Teeth per inch
Serrucho Costa - 12 Dientes por pulgadas

REF.	Tamanho Size Tamaño	EAN 789.1114	Embalagem Package Embalaje			Dimensões Dimensions (mm)		
			Un.	KG	Comp x larg x alt Length x width x height Largo x ancho x altura	A	B	C
43285/010	10"	00608 7	6	3,18	500 x 100 x 150mm	133	382	21
43285/012	12"	00609 4	6	3,53	500 x 100 x 150mm	133	432,8	21
43285/014	14"	00640 7	6	3,59	500 x 100 x 150mm	133	483,6	21

Lâmina em aço alto carbono temperado e lixado.
Cabo de madeira ergonômico e envernizado.
Dentes travados.
Proteção plástica para os dentes.

IPI 8% incluso - NCM: 8202.10.00

Hardened and polished high carbon steel blade.
Ergonomic and varnished hardwood handle.
Set teeth.
Plastic protection for the cutting area.

Lámina en acero alto carbono templado y lijado.
Mango de madera ergonómico barnizado.
Dientes trabados.
Protección plástica en el área de corte.

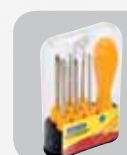
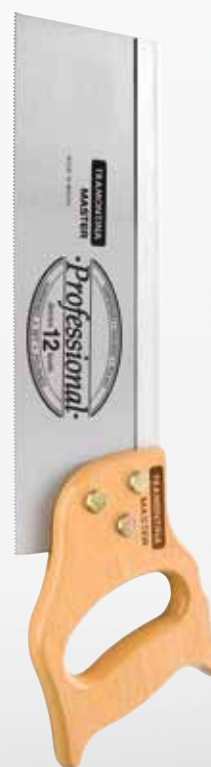
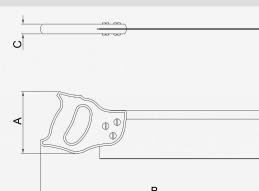



43290 Serrote de Poda - 5 Dentes por polegadas
Pruning Saw - 5 Teeth per inch
Serrucho de Poda - 5 Dientes por pulgadas

REF.	Tamanho Size Tamaño	EAN 789.1114	Embalagem Package Embalaje			Dimensões Dimensions (mm)		
			Un.	KG	Comp x larg x alt Length x width x height Largo x ancho x altura	A	B	C
43290/012	12"	00482 3	6	1,27	430 x 90 x 120mm	88	427	21
43290/014	14"	03836 1	6	1,46	500 x 100 x 150mm	88	494	21

Lâmina em aço alto carbono temperado e lixado.
Cabo de madeira ergonômico e envernizado.
Dentes travados.
Proteção plástica para os dentes.

IPI 0% incluso - NCM: 8201.90.00

Hardened and polished high carbon steel blade.
Ergonomic and varnished hardwood handle.
Set teeth.
Plastic protection for the cutting area.

Lâmina en acero alto carbono templado y lijado.
Mango de madera ergonômico barnizado.
Dientes trabados.
Protección plástica en el área de corte.

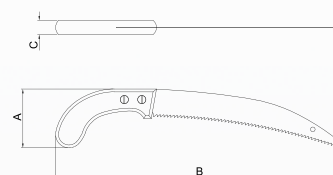

43293 Serrote de Poda - SUPERCUT - 6 Dentes por polegadas
Pruning Saw - SUPERCUT - 6 Teeth per inch
Serrucho de Poda - SUPERCUT - 6 Dientes por pulgadas

REF.	Tamanho Size Tamaño	EAN 789.1114	Embalagem Package Embalaje			Dimensões Dimensions (mm)		
			Un.	KG	Comp x larg x alt Length x width x height Largo x ancho x altura	A	B	C
43293/014	14"	05848 2	6	1,68	550 x 95 x 150mm	125	166,05	21

Lâmina em aço alto carbono temperado e lixado.
Cabo de madeira ergonômico e envernizado.
Dentes travados com dupla afiação.
Proteção plástica para os dentes.

IPI 0% incluso - NCM: 8201.90.00

Hardened and polished carbon steel blade.
Ergonomic and varnished hardwood handle.
Double sharpened set teeth.
Plastic protection for the cutting area.

Lâmina en acero alto carbono templado y lijado.
Mango de madera ergonômico barnizado.
Dientes trabados con doble filo.
Protección plástica en el área de corte.

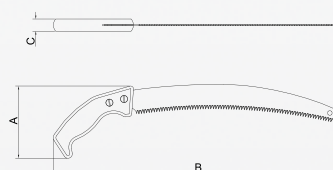

Dentes com dupla afiação.
Aggressive teeth.
Dientes con doble afilado.

43294 Serrote de Poda - SUPERCUT - 6 Dentes por polegadas
Pruning Saw - SUPERCUT - 6 Teeth per inch
Serrucho de Poda - SUPERCUT - 6 Dientes por pulgadas

REF.	Tamanho Size <i>Tamaño</i>	EAN 789.1114	Embalagem Package <i>Embalaje</i>			Dimensões Dimensions (mm)		
			Un.	KG	Comp x larg x alt Length x width x height <i>Largo x ancho x altura</i>	A	B	C
43294/014	14"	06292 2	6	1,30	550 x 95 x 150mm	85	540	30

Lâmina em aço alto carbono temperado e lixado.
Cabo ergonômico injetado.
Dentes travados com dupla afiação.
Proteção plástica para os dentes.

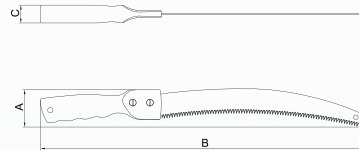

IPI 0% incluso - NCM: 8201.90.00

Hardened and polished carbon steel blade.
Ergonomic and injected handle.
Double sharpened set teeth.
Plastic protection for the cutting area.

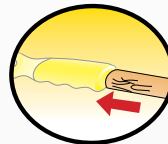

O cabo plástico permite adaptar prolongador.
The plastic handle enables the use of a longer handle.
Permite el uso de un mango más largo.

Lâmina en acero alto carbono templado y lijado.
Mango ergonómico inyectado.
Dientes trabados con doble filo.
Protección plástica en el área de corte.



Dentes com dupla afiação.
Aggressive teeth.
Dientes con doble afilado.

43291 Serrote de Poda Utility - Basic - 5 Dentes por polegadas
Utility Pruning Saw - Basic - 5 Teeth per inch
Serrucho de Poda Utility - Basic - 5 Dientes por pulgadas

REF.	Tamanho Size <i>Tamaño</i>	EAN 789.1114	Embalagem Package <i>Embalaje</i>			Dimensões Dimensions (mm)		
			Un.	KG	Comp x larg x alt Length x width x height <i>Largo x ancho x altura</i>	A	B	C
43291/012	12"	00962 0	6	0,97	570 x 95 x 80mm	50	464	27

Lâmina em aço carbono temperado e lixado.
Cabo de plástico.
Dentes travados com dupla afiação.
Proteção plástica para os dentes.

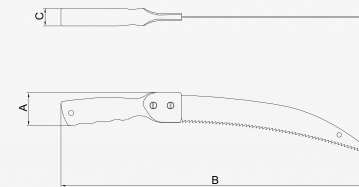

IPI 0% incluso - NCM: 8201.90.00

Hardened and polished carbon steel blade.
Injected handle.
Set teeth.
Plastic protection for the cutting area.

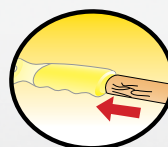

O cabo plástico permite adaptar prolongador.
The plastic handle enables the use of a longer handle.
Permite el uso de un mango más largo.

Lâmina en acero carbono templado y lijado.
Mango inyectado.
Dientes trabados.
Protección plástica en el área de corte.

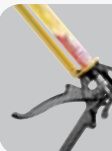
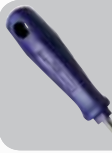

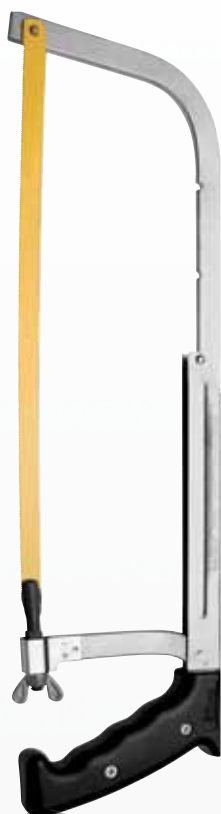

43302 Arco de Serra Regulável
Adjustable Hacksaw
Arco de Sierra Ajustable

REF.	Tamanho Size <i>Tamaño</i>	EAN 789.1114	Embalagem Package <i>Embalaje</i>			Dimensões Dimensions (mm)		
			Un.	KG	Comp x larg x alt Length x width x height <i>Largo x ancho x altura</i>	A	B	C
43302/012	12"	05455 2	12	6,60	480 x 200 x 140mm	127,5	437	24

Lâmina de 12".
Permite o uso de lâminas de 10" e 12".
Acabamento cromado.
Cabo ergonômico injetado.

IPI 8% incluso - NCM: 8202.10.00

12" blade.
Chrome plated finishing.
Ergonomic injected handle.
Suitable for 10" and 12" blades.

*Lámina de 12".
Acabado cromado.
Mango ergonômico injectado.
Permite el uso con láminas de 10" y 12"*

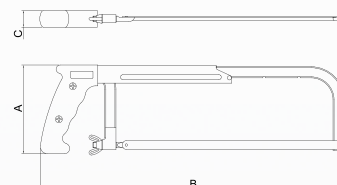

43301 Arco de Serra
Hacksaw
Arco de Sierra Fijo

REF.	Tamanho Size <i>Tamaño</i>	EAN 789.1114	Embalagem Package <i>Embalaje</i>			Dimensões Dimensions (mm)		
			Un.	KG	Comp x larg x alt Length x width x height <i>Largo x ancho x altura</i>	A	B	C
43301/012	12"	00126 6	12	5,39	480 x 200 x 140mm	127	453	28

Lâmina de 12".
Acabamento com pintura eletrostática na cor preta.
Cabo ergonômico injetado.

IPI 8% incluso - NCM: 8202.10.00

12" blade.
Black electrostatic painting.
Ergonomic injected handle.

*Lámina de 12".
Pintura electrostática negra.
Mango ergonômico injectado.*

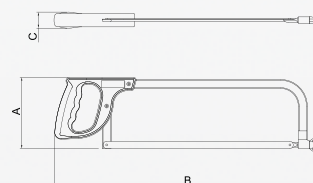

43315 Miniarco de Serra Mini Hacksaw Mini Arco de Sierra

REF.	Tamanho Size Tamaño	EAN 789.1114	Embalagem Package Embalaje			Dimensões Dimensions (mm)		
			Un.	KG	Comp x larg x alt Length x width x height Largo x ancho x altura	A	B	C
43315/012	10"	02682 5	12	0,60	275 x 95 x 80mm	48	225	11

Lâmina de 10".
Cabo ergonômico injetado.

IPI 8% incluso - NCM: 8202.10.00

10" blade.
Ergonomic injected handle.

Lâmina de 10".
Mango ergonômico injectado.

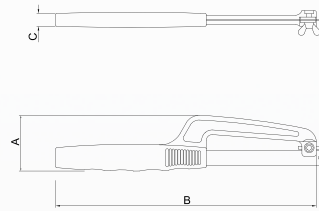

43330 Formão Wood Chisel Formón

REF.	Tamanho Size Tamaño	EAN 789.1114	Embalagem Package Embalaje			Dimensões Dimensions (mm)		
			Un.	KG	Comp x larg x alt Length x width x height Largo x ancho x altura	A	B	C

SUPOORTE PLÁSTICO | PLASTIC HANGER | SOPORTE PLÁSTICO

43330/101	1/4"	02375 6	12	1,42	350 x 175 x 90mm	6,5	257	30
43330/102	3/8"	02376 3	12	1,65	350 x 175 x 90mm	10	257	30
43330/103	1/2"	02377 0	12	1,73	350 x 175 x 90mm	13	257	30
43330/104	5/8"	02378 7	12	1,92	350 x 175 x 90mm	16	257	30
43330/105	3/4"	02379 4	12	1,92	350 x 175 x 90mm	19	257	30
43330/106	7/8"	02380 0	12	2,11	350 x 175 x 90mm	22	257	30
43330/107	1"	02381 7	12	2,24	350 x 175 x 90mm	26	257	30
43330/108	1.1/4"	02382 4	12	2,41	350 x 175 x 90mm	32	257	30
43330/109	1.1/2"	02383 1	12	2,67	350 x 175 x 90mm	38	257	30

Lâmina em aço cromo vanádio temperado e lixado.
Lâmina chanfrada e polida.
Cabo de madeira ergonômico envernizado.

IPI 8% incluso - NCM: 8205.30.00

Hardened and polished chrome vanadium steel blade.
Beveled edges and polished blade.
Ergonomic varnished hardwood handle.

Lâmina en acero cromo vanádio templado y lijado.
Lâmina chanfleada y pulida.
Mango de madera barnizado.

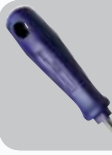
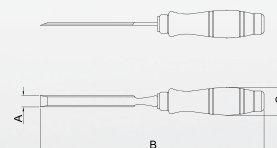



43331 Jogo de Formões
Wood Chisel Set
Juego de Formones

REF.	Peças Pieces Piezas	EAN 789.1114	Embalagem Package Embalaje		
			Un.	KG	Comp x larg x alt Length x width x height Largo x ancho x altura
43331/502	2	03769 2	12	3,55	435 x 255 x 125mm

Composição | Set includes | *Composición:*

- 3/8", 5/8".
- Clam pack.

IPI 8% incluso - NCM: 8205.30.00



43331 Jogo de Formões
Wood Chisel Set
Juego de Formones

REF.	Peças Pieces Piezas	EAN 789.1114	Embalagem Package Embalaje		
			Un.	KG	Comp x larg x alt Length x width x height Largo x ancho x altura
43331/504	4	06042 3	12	7,41	435 x 360 x 190mm

Composição | Set includes | *Composición:*

- 3/8", 1/2", 5/8", 3/4".
- Clam pack.

IPI 8% incluso - NCM: 8205.30.00

43333 Formão Forjado Forged Wood Chisel Formón Forjado

REF.	Tamanho Size Tamaño	EAN 789.1114	Embalagem Package Embalaje			Dimensões Dimensions (mm)				
			Un.	KG	Comp x larg x alt Length x width x height Largo x ancho x altura	A	B	C	D	E
SOPORTE PLÁSTICO PLASTIC HANGER SOPORTE PLÁSTICO 										
43333/103	1/2"	09341 4	12	2,16	350 x 170 x 140mm	30	120	262	13	4,5
43333/105	3/4"	09342 1	12	2,40	350 x 170 x 140mm	30	120	262	19	4,5
43333/107	1"	09343 8	12	2,64	350 x 170 x 140mm	30	120	262	25	4,5
43333/109	1.1/2"	09344 5	12			30	120	262	38	4,5

Lâmina forjada em aço cromo vanádio e temperada.
Lâmina chanfrada e polida.
Cabo injetado

IPI 8% incluso - NCM: 8205.30.00

Forged and hardened chrome vanadium steel blade.
Beveled edges and polished blade.
Injected handle.

Lámina forjada en acero cromo vanádio y templada.
Lámina chanfleada y pulida.
Mango inyectado.

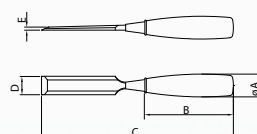

43335 Formão Wood Chisel Formón

REF.	Tamanho Size Tamaño	EAN 789.1114	Embalagem Package Embalaje			Dimensões Dimensions (mm)		
			Un.	KG	Comp x larg x alt Length x width x height Largo x ancho x altura	A	B	C
43335/001	1/4"	00285 0	12	0,90	270 x 122 x 82mm	6,5	258	30
43335/002	3/8"	00286 7	12	1,20	270 x 122 x 82mm	10	258	30
43335/003	1/2"	00287 4	12	1,30	270 x 122 x 82mm	13	258	30
43335/004	5/8"	00288 1	12	1,40	270 x 122 x 82mm	16	258	30
43335/005	3/4"	00289 8	12	1,50	270 x 122 x 82mm	19	258	30
43335/006	7/8"	00290 4	12	1,60	270 x 122 x 82mm	22	258	30
43335/007	1"	00291 1	12	1,70	270 x 122 x 82mm	26	258	30
43335/008	1.1/4"	01734 2	12	1,90	270 x 122 x 82mm	32	258	30
43335/009	1.1/2"	01735 9	12	2,10	270 x 122 x 82mm	38	258	30

Lâmina em aço cromo vanádio temperado e lixado.
Lâmina chanfrada e polida.
Cabo injetado.

IPI 8% incluso - NCM: 8205.30.00

Hardened and polished chrome vanadium steel blade.
Beveled edges and polished blade.
Injected handle.



Lámina en acero cromo vanádio templado y lijado.
Lámina chanfleada y pulida.
Mango inyectado.



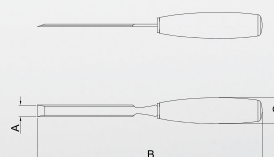

43336 Jogo de Formões
Wood Chisel Set
Juego de Formones

REF.	Peças Pieces Piezas	EAN 789.1114	Embalagem Package Embalaje		
			Un.	KG	Comp x larg x alt Length x width x height Largo x ancho x altura
43336/502	2	06032 4	12	3,065	305 x 246 x 150mm

Composição | Set includes | *Composición:*

- 3/8", 5/8".
- Clam pack.

IPI 8% incluso - NCM: 8205.30.00



43336 Jogo de Formões
Wood Chisel Set
Juego de Formones

REF.	Peças Pieces Piezas	EAN 789.1114	Embalagem Package Embalaje		
			Un.	KG	Comp x larg x alt Length x width x height Largo x ancho x altura
43336/504	4	00452 6	10	4,80	425 x 297 x 180mm

Composição | Set includes | *Composición:*

- 3/8", 1/2", 5/8", 3/4".
- Clam pack.

IPI 8% incluso - NCM: 8205.30.00

43350 Plaina Block nº 2 - Basic
Block Plane - Basic
Cepillo Block - Basic

REF.	Tamanho Size <i>Tamaño</i>	EAN 789.1114	Embalagem Package <i>Embalaje</i>			Dimensões Dimensions (mm)		
			Un.	KG	Comp x larg x alt Length x width x height <i>Largo x ancho x altura</i>	A	B	C
43350/002	7"	00022 1	12	7,50	380 x 235 x 135mm	50	175	75

Corpo em chapa de aço estampada.
Lâmina em aço cromo vanádio.
Lâmina de 1.3/4"
Cabo injetado.

IPI 8% incluso - NCM: 8205.30.00

Stamped steel body.
Chrome vanadium steel blade.
1.3/4" blade.
Injected handle.

*Cuerpo en chapa estampada.
Lámina en acero cromo vanadio.
Lámina de 1.3/4".
Mango inyectado.*

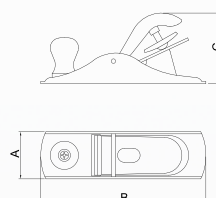

Veja lâminas avulsas na pág. 169.
Check spare blades on the page 169.
Veá láminas sueltas en la pagina 169.



43352 Plaina nº 3
Plane nr. 3
Cepillo nr. 3

REF.	Tamanho Size <i>Tamaño</i>	EAN 789.1114	Embalagem Package <i>Embalaje</i>			Dimensões Dimensions (mm)		
			Un.	KG	Comp x larg x alt Length x width x height <i>Largo x ancho x altura</i>	A	B	C
43352/003	9.3/4"	00023 8	12	12,00	385 x 293 x 282mm	58,5	245	116,5

Corpo em chapa de aço estampada.
Lâmina em aço cromo vanádio.
Lâmina de 2".
Cabo de madeira envernizado.

IPI 8% incluso - NCM: 8205.30.00

Stamped steel body.
Chrome vanadium steel blade.
2" blade.
Varnished hardwood handle.

*Cuerpo en chapa estampada.
Lámina en acero cromo vanadio.
Lámina de 2".
Mango de madera barnizado.*

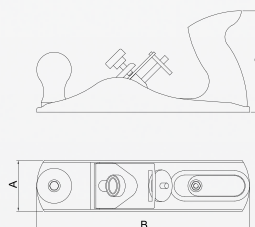

Veja lâminas avulsas na pág. 170.
Check spare blades on the page 170.
Veá láminas sueltas en la pagina 170.

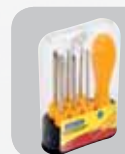



41170 Estilete Estreito - Basic
* **Retractable Knife - Basic**
Cortadora - Basic

REF.	Tamanho Size Tamaño	EAN 789.1114	Embalagem Package Embalaje			Dimensões Dimensions (mm)			
			Un.	KG	Comp x larg x alt Length x width x height Largo x ancho x altura	A	B	C	D
CLAM PACK									
41170/300	130mm	06150 5	36	0,79	205 x 160 x 120mm	9	131	20	11
			360	9,07	620 x 220 x 335mm				

Corpo injetado.
Lâmina em aço carbono temperado.
Dispositivo para travar a lâmina.

IPI 12% incluso - NCM: 8211.93.90

Injected body.
Hardened carbon steel blade.
Safety lock system for the blade.

Cuerpo inyectado.
Láminas en acero carbono templado.
Dispositivo con traba de seguridad.

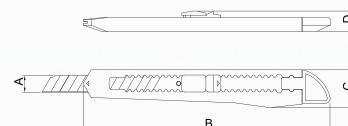

Veja lâminas avulsas na pág. 169.
Check spare blades on the page 169.
Vea láminas sueltas en la pagina 169.



43390 Estilete - Basic
* **Retractable Knife - Basic**
Cortadora - Basic

REF.	Tamanho Size Tamaño	EAN 789.1114	Embalagem Package Embalaje			Dimensões Dimensions (mm)		
			Un.	KG	Comp x larg x alt Length x width x height Largo x ancho x altura	A	B	C
CLAM PACK								
43390/300	6"	00966 8	36	1,81	250 x 250 x 65mm	47	152	20
			360	19,91	885 x 265 x 540mm			

Corpo injetado.
Lâmina em aço carbono temperado.
Dispositivo para travar a lâmina.

IPI 12% incluso - NCM: 8211.93.90

Injected body.
Hardened carbon steel blade.
Safety lock system for the blade.

Cuerpo inyectado.
Láminas en acero carbono templado.
Dispositivo con traba de seguridad.

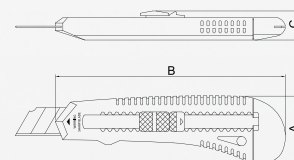

Veja lâminas avulsas na pág. 169.
Check spare blades on the page 169.
Vea láminas sueltas en la pagina 169.

43390 Estilete Profissional
* **Professional Retractable Knife**
Cortadora Profissional

REF.	Tamanho Size <i>Tamaño</i>	EAN 789.1114	Embalagem Package <i>Embalaje</i>			Dimensões Dimensions (mm)		
			Un.	KG	Comp x larg x alt Length x width x height <i>Largo x ancho x altura</i>	A	B	C
CLAM PACK								
43390/301	6"	05179 7	24	2,41	250 x 250 x 185mm	41	152	26
			144	15,42	510 x 260 x 580mm			

Corpo injetado.
Lâmina em aço carbono temperado.
Dispositivo para travar a lâmina.
Estrutura interna de metal.
Compartimento para guardar lâminas extras.
Duas lâminas extras.

IPI 12% incluso - NCM: 8211.93.90

Injected body.
Hardened carbon steel blade.
Safety lock system for the blade.
Metal internal structure.
Compartment for blades storage.
Two extra blades.

*Cuerpo inyectado.
Láminas en acero carbono templado.
Dispositivo con traba de seguridad.
Estructura interna de metal.
Compartimiento para almacenar las láminas.
Dos láminas extras.*

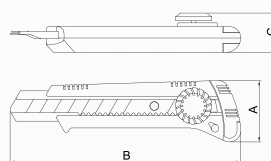

Veja lâminas avulsas na pág. 169.
Check spare blades on the page 169.
Veja lâminas sueltas en la pagina 169.



43390 Estilete Profissional
* **Professional Retractable Knife**
Cortadora Profissional

REF.	Tamanho Size <i>Tamaño</i>	EAN 789.1114	Embalagem Package <i>Embalaje</i>			Dimensões Dimensions (mm)		
			Un.	KG	Comp x larg x alt Length x width x height <i>Largo x ancho x altura</i>	A	B	C
CLAM PACK								
43390/302	6"	05752 2	24	2,77	250 x 225 x 145mm	48,5	155	22,5
			120	14,49	740 x 275 x 250mm			

Corpo injetado.
Lâmina em aço carbono temperado.
Dispositivo para travar a lâmina.
Estrutura interna de metal.
Compartimento para guardar lâminas extras.
Duas lâminas extras.
Empunhadura emborrachada.

IPI 12% incluso - NCM: 8211.93.90

Injected body.
Hardened carbon steel blade.
Safety lock system for the blade.
Metal internal structure.
Compartment for blades storage.
Two extra blades.
Rubber cover.

*Cuerpo inyectado.
Láminas en acero carbono templado.
Dispositivo con traba de seguridad.
Estructura interna de metal.
Compartimiento para almacenar las láminas.
Dos láminas extras.
Empuñadura en goma.*

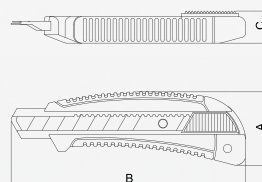

Veja lâminas avulsas na pág. 169.
Check spare blades on the page 169.
Veja lâminas sueltas en la pagina 169.

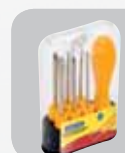



7

GRAMPOS E PISTOLA APLICADORA DE SILICONE

SILICONE CAULKING GUN

PISTOLA APLICADORA DE SILICONA Y GRAMPADORAS





43199 Pistola Aplicadora de Silicone
* Silicone Caulking Gun
Pistola para Silicona

REF.	Tamanho Size Tamaño	EAN 789.1114	Embalagem Package Embalaje			Dimensões Dimensions (mm)		
			Un.	KG	Comp x larg x alt Length x width x height Largo x ancho x altura	A	B	C
43199/002		08862 5	1	0,55	380 x 225 x 80mm	218	360	52
			24	13,50	400 x 250 x 300mm			

Corpo em chapas de aço carbono.
Pintura eletrostática a pó.
Utilizado com tubo de silicone de 9".

IPI 8% incluso - NCM: 8205.59.00

Body in carbon steel sheets.
Electrostatic painting.
Suitable for 9" silicone tube.

*Cuerpo en chapas de acero carbono.
Pintura electrostática.
Utilizado en tubo de silicona de 9".*

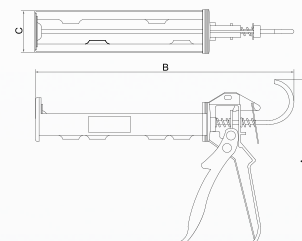

43190 Grampo tipo "C" (Sargento)
* C Type Clip
Clip tipo C

REF.	Tamanho Size Tamaño	EAN 789.1114	Embalagem Package Embalaje			Dimensões Dimensions (mm)		
			Un.	KG	Comp x larg x alt Length x width x height Largo x ancho x altura	A	B	C
43190/002	2"	04937 4	25	5,67	340 x 130 x 80mm	64	93	18
			100	23,36	350 x 280 x 180mm			
43190/003	3"	05153 7	12	5,33	210 x 170 x 110mm	87	142	24
			48	22,26	370 x 230 x 230mm			
43190/004	4"	04938 1	9	5,97	210 x 185 x 125mm	100	170	25,5
			36	24,24	380 x 220 x 255mm			
43190/006	6"	04939 8	8	9,29	300 x 200 x 150mm	130	242	32
			24	28,74	320 x 220 x 450mm			
43190/008	8"	04940 4	8	12,61	350 x 215 x 165mm	135	300	32,5
			16	26,05	440 x 380 x 180mm			
43190/010	10"	04941 1	5	10,64	400 x 130 x 165mm	160	348	35
			10	21,83	410 x 270 x 190mm			
43190/012	12"	04942 8	4	12,65	420 x 150 x 200mm	175	403	36
			8	25,98	450 x 320 x 225mm			

Corpo em aço fundido reforçado.
Acabamento com pintura eletrostática a pó.

IPI 8% incluso - NCM: 8205.70.00

Reinforced cast steel.
Electrostatic painting.

*Cuerpo en acero fundido reforzado.
Pintura electrostática.*

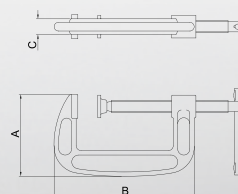

43194 Grampo de Ação Rápida

* Fast Action Clip
Clip de Acción Rápida

REF.	Tamanho Size Tamaño	EAN 789.1114	Embalagem Package Embalaje			Dimensões Dimensions (mm)		
			Un.	KG	Comp x larg x alt Length x width x height Largo x ancho x altura	A	B	C
43194/006	6"	08258 6	6	5,01	430 x 265 x 120mm	255	370	40
			24	20,94	560 x 450 x 260mm			
43194/012	12"	08259 3	6	5,85	530 x 265 x 115mm	255	524	40
			24	24,20	540 x 280 x 490mm			

Corpo em náilon.
Mandíbulas em borracha.
Permite utilizar mandíbula com posicionamento invertido.

Nylon body.
Rubber jaws.
It's possible to use the jaws with a reversed position.

IPI 8% incluso - NCM: 8205.70.00

Cuerpo en nylon.
Mandíbulas en goma.
Permite utilizar las mandíbulas con las posiciones invertidas.

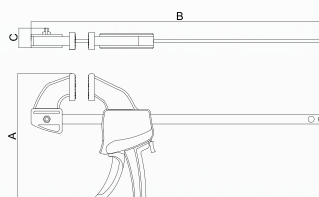

43192 Grampo Plástico

* Plastic Clip
Clip Plástico

REF.	Tamanho Size Tamaño	EAN 789.1114	Embalagem Package Embalaje			Dimensões Dimensions (mm)		
			Un.	KG	Comp x larg x alt Length x width x height Largo x ancho x altura	A	B	C
43192/001	1"	05851 2	12	0,81	255 x 160 x 75mm	80	114	33,5
			200	13,58	460 x 290 x 280mm			
43192/002	2"	05852 9	12	1,62	370 x 195 x 100mm	107	164	37
			48	6,94	430 x 265 x 320mm			
43192/003	3"	05853 6	12	2,33	435 x 255 x 125mm	146	210	41,5
			120	23,09	610 x 400 x 290mm			

Corpo em náilon.
Mandíbulas em borracha.

Nylon body.
Rubber jaws.
Cuerpo en nylon.
Mandíbulas en goma.

IPI 15% incluso - NCM: 3926.90.90

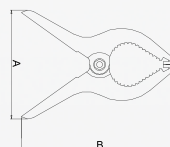

43500 Grampeador Manual

* Manual Stapler
Grapadora Manual

REF.	Tamanho Size Tamaño	EAN 789.1114	Embalagem Package Embalaje			Dimensões Dimensions (mm)		
			Un.	KG	Comp x larg x alt Length x width x height Largo x ancho x altura	A	B	C
43500/500		08046 9	6	5,60	330 x 255 x 210mm	165	202	35
			24	23,28	510 x 355 x 440mm			

Corpo em liga de alumínio injetado.
Cabo com dupla injeção em plástico e borracha.
Sistema seguro de trava manual.
Inclui 1.000 grampos HT50

Cuerpo en liga de aluminio inyectada.
Mango con doble inyección en plastic y goma.
Sistema seguro de traba manual.
Incluí 1.000 grapas HT50.

IPI 8% incluso - NCM: 8205.59.00

Injected body in aluminum alloy.
Double injected handle in plastic and rubber.
Handle safety locking system.
1.000 staple pins HT50 are included.

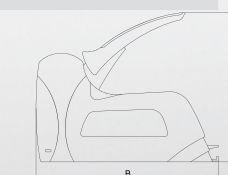

Veja grampos avulsos na pág. 170.
Check the spare staples on the page 170.
Vea grapas sueltas en la pagina 170.



FERRAMENTAS ELÉTRICAS E LANTERNAS
ELECTRICAL TOOLS AND FLASHLIGHTS
HERRAMIENTAS ELECTRICAS Y LINTERNAS





43752 Ferro de Solda
* Welding Iron
Hierro de Soldadura

REF.	Voltagem Power Voltaje	EAN 789.1114	Embalagem Package Embalaje			Dimensões Dimensions (mm)		
			Un.	KG	Comp x larg x alt Length x width x height Largo x ancho x altura	A	B	C
CLAM PACK								
43752/502	127V 25 Watts	04772 1	12 48	2,40 9,30	370 x 100 x 290mm 413 x 388 x 302mm	32	235	3,75
43752/503	220V 25 Watts	04782 0	12 48	2,25 8,90	370 x 100 x 290mm 413 x 388 x 302mm	32	235	3,75
43752/504	127V 40 Watts	05359 3	12 48	1,90 8,39	305 x 180 x 155mm 370 x 320 x 320mm	32	250	5
43752/505	220V 40 Watts	05360 9	12 48	1,90 8,40	295 x 175 x 155mm 365 x 325 x 325mm	32	250	5
43752/506	127V 70 Watts	05361 6	12 48	2,35 10,21	345 x 175 x 150mm 375 x 370 x 330mm	32	290	7
43752/507	220V 70 watts	05362 3	12 48	2,30 10,24	340 x 180 x 140mm 370 x 370 x 325mm	32	290	7

Ponteira e haste metálicas.
Cabo plástico.
Suporte de metal para descanso.
Cabo elétrico de 1 metro.
Acompanha manual de instruções.

IPI 5% incluso - NCM: 8515.11.00

Metal tip and blade.
Plastic handle.
1 meter electric wire length.
Instructions manual included.

*Puntera y asta metálica.
Mango plástico.
Soporte de metal para descanso.
Cable eléctrico de 1 metro.
Manual de instrucciones incluido.*

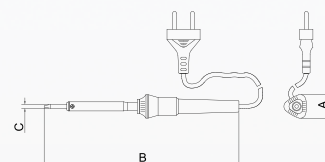

43755 Pistola Elétrica Aplicadora de Cola
* Electric Glue Gun
Pistola Eléctrica Aplicadora de Cola

REF.	Voltagem Power Voltaje	EAN 789.1114	Embalagem Package Embalaje			Dimensões Dimensions (mm)		
			Un.	KG	Comp x larg x alt Length x width x height Largo x ancho x altura	A	B	C
CLAM PACK								
43755/510	10 Watts	01538 6	6 48	1,07 9,83	230 x 205 x 155mm 490 x 430 x 340mm	113	103	22,5
43755/530	30 Watts	04947 3	12 48	3,48 15,22	470 x 270 x 175mm 560 x 495 x 380mm	141	163	31
43755/560	60 Watts	04780 6	12 48	4,41 18,91	480 x 295 x 200mm 610 x 490 x 430mm	162	197	31,5

Corpo injetado em plástico.
Ponta metálica.
Bi-volt automático.
Acompanha 2 bastões de cola de silicone.

IPI 15% incluso - NCM: 8516.79.90

Plastic injected body.
Metal tip.
Automatic dual voltage system.
With 2 glue sticks.

*Mango inyectado en plástico.
Punta metálica.
Bi-volt automático.
Con 2 bastones de cola.*

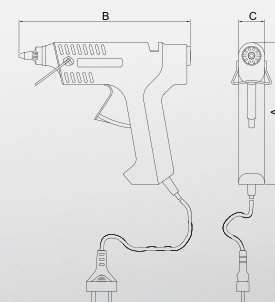

Veja bastões avulsos na pág. 171.
Check spare gluesticks on the page 171.
Vea bastones de cola sueltos en la pagina 171.

43760 Holofote
* **Rubberized Flashlight**
Linterna

REF.	Peso Weight	EAN 789.1114	Embalagem Package Embalaje			Dimensões Dimensions (mm)		
			Un.	KG	Comp x larg x alt Length x width x height Largo x ancho x altura	A	B	C
BLISTER CLAM PACK 								
43760/300	630g	08868 7	4	3,0	325 x 310 x 303mm	132	210	120
			16	12,0	632 x 332 x 625mm			

Corpo em ABS reforçado, resistente a impactos.
Lâmpada de krypton de 4,8V - 0,75A.
O uso do gás Krypton em lâmpadas incandescentes aumenta o brilho em até 70%, pois oferece uma luz muito mais clara que a luz amarelada das lâmpadas comuns.
Utiliza 1 bateria de 6V (não inclusa) ou 4 pilhas "D" 1,5V (não inclusas).
Acompanha adaptador para pilhas.
Resistente à água, óleo e lubrificantes.
Ideal para uso interno e externo: pesca, camping, náutica, etc.

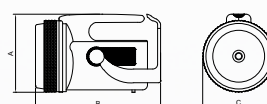

IPI 15% incluso - NCM: 8513.10.10

Reinforced and shocks resistant ABS body.
4.8V - 0.75A krypton lamp.
The use of krypton gas in incandescent lamps increases 70% of brightness, because it offers a whiter light compared to normal lamps.
Works by 6V battery (not included) or 4 x 1.5 V "D" cells (not included).
With battery adaptor.
Water, oil and lubricant resistant.
Proper to indoor and outdoor use: fishing, camping, navigation, etc.



*Cuerpo en ABS reforzado resistente a impactos.
Lámpara de criptón de 4,8V - 0,75A.
El uso del gas criptón en lámparas incandescentes incrementa el brillo en hasta un 70% pues ofrece una luz mucho más clara que la luz amarillada de lámparas comunes.
Utiliza 1 batería de 6V (no inclusa) o 4 pilas "D" 1,5V (no inclusas).
Viene con adaptador para pilas.
Resiste el agua, aceite y lubricantes.
Propia para uso interno y externo: pesca, camping, náutica, etc.*

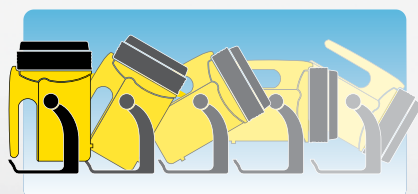

5 posições de apoio
5 support positions
5 posiciones de apoyo



Resistente à água
Waterproof
Resistente al agua



Flutua na água
Floats in water
Flota en el agua

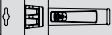

43757 Lanterna Plástica
* Plastic Flashlight
Linterna

REF.	Pilhas Cells Pílas	EAN 789.1114	Embalagem Package Embalaje			Dimensões Dimensions (mm)		
			Un.	KG	Comp x larg x alt Length x width x height Largo x ancho x altura	A	B	C
BLISTER CLAM PACK 								
43757/300	2 AA	08866 3	6	0,68	160 x 155 x 200mm	47	152	29,5
			36	4,1	482 x 330 x 220mm			
43757/301	2 D	08865 6	6	1,6	232 x 232 x 260mm	70	195	45
			36	6,96	714 x 475 x 280mm			

Corpo em injetado em plástico PP.
Lâmpada de Krypton 2,4V - 0,75A.
Lente em policarbonato.
O uso do gás Krypton em lâmpadas incandescentes aumenta o brilho em até 70%, pois oferece uma luz muito mais clara que a luz amarelada das lâmpadas comuns.
Pilhas não inclusas.

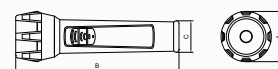

IPI 15% incluso - NCM: 8513.10.10

Injected PP body.
2.4V – 0.75A krypton lamp.
Polycarbonate lens.
The use of krypton gas in incandescent lamps increases 70% of brightness, because it offers a whiter light compared to normal lamps.
Cells not included.

*Cuerpo inyectado en plástico PP.
Lámpara de criptón de 2,4V – 0,75A.
Lente en policarbonato.
El uso del gas criptón en lámparas incandescentes incrementa el brillo en hasta un 70% pues ofrece una luz mucho más clara que la luz amarillada de lámparas comunes.
Pilas no inclusas.*

43761 Lanterna de Alumínio
* Aluminum Flashlight
Linterna

REF.	Pilhas Cells Pilas	EAN 789.1114	Embalagem Package Embalaje			Dimensões Dimensions (mm)		
			Un.	KG	Comp x larg x alt Length x width x height Largo x ancho x altura	A	B	C
BLISTER CLAM PACK 								
43761/300	2AA	08870 0	6	0,75	250 x 125 X 105mm	29	170	18
			24	3,0	270 x 230 x 270mm			
43761/301	2D	08869 4	4	1,6	355 x 210 x 150mm	55,7	242	38,7
			16	7,5	440 x 375 x 320mm			
43761/302	3D	08867 0	4	2,0	415 x 210 x 150mm	55,7	304	38,7
			16	8,5	440 x 435 x 320mm			

Corpo em alumínio anodizado que previne arranhões e oxidações.
Anéis internos e botão liga/desliga emborrachados.
Lente em policarbonato.
Empunhadura com ranhuras para maior agarre.
Resistente à água e a impactos.
Ideal para uso interno e externo: pesca, camping, náutica, etc.
Pilhas não incluídas.



IPI 15% incluso - NCM: 8513.10.10

Anodized aluminum body which prevents damage and rust.
Rubberized internal rings and buttons.
Polycarbonate lens.
Handle with special grooves for better gripping.
Water and impact resistant.
Cells not included.

*Cuerpo en aluminio anodizado que previene rayas y la oxidación.
Anillos internos y botón prende/desliga de goma.
Lente de policarbonato.
Empuñadura con ranuras para un mejor agarre.
Resiste el agua e impactos.
Propia para uso interno y externo: pesca, camping, náutica, etc.
Pilas no incluidas.*

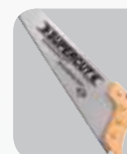

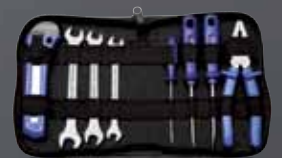

**JOGOS E ORGANIZADORES
DE FERRAMENTAS
SETS AND TOOL STORAGE
JUEGOS Y ORGANIZADORES DE HERRAMIENTAS**





41110 Jogo de Chaves de Fenda - Basic
Screwdriver Set - Basic
Juego de Destornilladores - Basic

REF.	Peças Pieces Piezas	EAN 789.1114	Embalagem Package Embalaje		
			Un.	KG	Comp x larg x alt Length x width x height Largo x ancho x altura
41110/506	6	08817 5	12	2,87	270 x 210 x 160mm

Composição:

- 3 Chaves de fenda ponta chata: 1/8x3", 3/16x3", 1/4x3";
- 3 Chaves de fenda ponta cruzada: 1/8x3", 3/16x3", 1/4x3".

IPI 8% incluso - NCM: 8205.40.00

Set includes:

- 3 Slotted tip screwdrivers: 1/8x3", 3/16x3", 1/4x3";
- 3 Cross recessed tip screwdrivers: 1/8x3", 3/16x3", 1/4x3".

Composición:

- 3 Destornilladores punta chata: 1/8x3", 3/16x3", 1/4x3";
- 3 Destornilladores punta cruzada: 1/8x3", 3/16x3", 1/4x3".



41175 Jogo de Ferramentas - Basic - Ideal para carro
Tool Set - Basic - Ideal for car
Juego de Herramientas - Basic - Ideal para autos

REF.	Peças Pieces Piezas	EAN 789.1114	Embalagem Package Embalaje		
			Un.	KG	Comp x larg x alt Length x width x height Largo x ancho x altura
41175/508	8	08825 0	6	3,42	360 x 380 x 381mm

Composição:

- Alicate universal 6";
- 2 Chaves de fenda ponta chata: 1/8x3", 3/16x3";
- 2 Chaves de fenda ponta cruzada 1/8x3", 3/16x3";
- Estilete retráctil;
- Lanterna;
- Luvas;
- Estojo sintético.

IPI 8% incluso - NCM: 8205.40.00

Set includes:

- 6" Combination pliers;
- 2 Slotted tip screwdrivers: 1/8x3", 3/16x3";
- 2 Cross recessed tip screwdrivers: 1/8x3", 3/16x3";
- Retractable knife;
- Gloves;
- Flashlight;
- Bag.

Composición:

- Pinza universal 6";
- 2 Destornilladores punta chata 1/8x3", 3/16x3";
- 2 Destornilladores punta cruzada 1/8x3", 3/16x3";
- Cortadora;
- Guantes;
- Linterna;
- Bolsa.

41175 **Jogo de Ferramentas - Basic - Ideal para casa**
Tool Set - Basic - Ideal for home
Juego de Herramientas - Basic - Ideal para el hogar

REF.	Peças Pieces Piezas	EAN 789.1114	Embalagem Package Embalaje		
			Un.	KG	Comp x larg x alt Length x width x height Largo x ancho x altura
41175/509	9	08824 3	6	5,56	360 x 380 x 381mm

Composição:

- Martelo de unha 20mm;
- Alicates universal 6";
- 2 Chaves de fenda ponta chata: 1/8x3", 3/16x3";
- 2 Chaves de fenda ponta cruzada 1/8x3", 3/16x3";
- Estilete retrátil;
- Lanterna;
- Trena 2m;
- Estojo sintético.

IPI 8% incluso - NCM: 8205.40.00

Set includes:

- 20mm claw hammer;
- 6" Combination pliers;
- 2 Slotted tip screwdrivers: 1/8x3", 3/16x3";
- 2 Cross recessed tip screwdrivers: 1/8x3", 3/16x3";
- Retractable knife;
- 2m Measuring tape;
- Flashlight;
- Bag.

Composición:

- Martillo de uña 20mm;
- Pinza universal 6";
- 2 Destornilladores punta chata 1/8x3", 3/16x3";
- 2 Destornilladores punta cruzada 1/8x3", 3/16x3";
- Cortadora;
- Cinta métrica 2m;
- linterna;
- Bolsa.

41180 **Chave de Fenda com Ponteiras - Basic**
*** Screwdriver with Tips - Basic**
Destornillador con Punteras - Basic

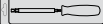
REF.	Peças Pieces Piezas	EAN 789.1114	Embalagem Package Embalaje		
			Un.	KG	Comp x larg x alt Length x width x height Largo x ancho x altura
EMBALAGEM BLISTER					
41180/001	4	06143 7	12	2,17	270 x 245 x 125mm
			24	4,88	280 x 260 x 270mm

Cabo injetado em polipropileno.

Possui uma haste que serve de suporte para as ponteiras.

A haste e as ponteiras são colocadas e retiradas através de encaixe rápido, com uma esfera.

Composição:

- 1 ponteira 3/16" com ponta chata 5,5mm e ponta cruzada nº 1;
- 1 ponteira 1/4" com ponta chata 6,5mm e ponta cruzada nº 2.

IPI 8% incluso - NCM: 8205.40.00

Injected plastic handle.

Blade that can be used as a support for the bits.

The blades and bits are inserted and removed through quick change drive with a sphere.

Set includes:

- 3/16" bit with 5.5mm slotted tip and nr. 1 recessed tip;
- 1/4" bit with 6.5mm slotted tip and nr. 2 recessed tip.

Mango en plástico inyectado.

Asta que sirve de soporte para las punteras.

El asta y las punteras son colgadas y sacadas a través de encaje rápido con una esfera.

Composición:

- Puntera 3/16" con punta chata 5.5mm y punta cruzada nº 1;
- Puntera 1/4" con punta chata 6.5mm y punta cruzada nº 2.

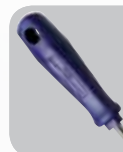



43411 Chave de Fenda com Ponteiras - Basic
* Screwdriver with Bits - Basic
Destornillador con Punteras - Basic

REF.	Peças Pieces Piezas	EAN 789.1114	Embalagem Package Embalaje		
			Un.	KG	Comp x larg x alt Length x width x height Largo x ancho x altura
EMBALAGEM BLISTER 					
43411/001	7	05196 4	25	4,07	310 x 275 x 130mm
			100	17,05	560 x 335 x 270mm

Corpo injetado em polipropileno azul com empunhadura em borracha preta.
Ponteiras em aço carbono.
Haste em aço carbono com imã para fixação das ponteiras.

Composição:

- 2 Ponteiras ponta chata 5 e 6.5mm;
- 4 Ponteiras ponta cruzada nº 0, 1, 2 e 3.

IPI 8% incluso - NCM: 8205.40.00

Injected plastic handle.
Carbon steel tips.
Carbon steel blade with magnetized tip to fix the bits.
Internal compartment to store the bits.

*Mango en plástico injectado.
Punteras en acero carbono.
Asta en acero carbono con imán para fijar las puntas.
Compartimiento interno para guardar las punteras.*

Set includes:

- 2 Slotted tips 5 and 6.5mm;
- 4 cross recessed tips nr. 0, 1, 2, 3.

Composición:

- 2 Punteras con punta chata 5, 6.5mm;
- 4 punteras punta cruzada nº 0, 1, 2, 3.



41905 Jogo de Chaves de Precisão - Basic
* Precision Wrench Set - Basic
Juego de Llaves de Precisión - Basic

REF.	Peças Pieces Piezas	EAN 789.1114	Embalagem Package Embalaje		
			Un.	KG	Comp x larg x alt Length x width x height Largo x ancho x altura
41905/306	6	04773 8	12	1,41	205 x 115 x 225mm
			48	6,13	425 x 245 x 250mm

Haste em aço cromo vanádio.
Acabamento fosfatizado.
Possui cabeça giratória para facilitar o manuseio com apenas uma das mãos.
Acompanha estojo plástico para guardar as chaves.

Composição:

- 4 Chaves de ponta chata 1.4, 2, 2.4, 3mm;
- 2 Chaves de ponta cruzada nr. 0, nr. 1.

IPI 8% incluso - NCM: 8205.40.00

Set Includes:
• 4 Wrench slotted tip 1.4, 2, 2.4, 3mm;
• 2 wrenches cross recessed tip nr. 0, nr. 1;
• Plastic case.

Composición:

- 4 Llaves punta chata 1.4, 2, 2.4, 3mm;
- 2 Llaves punta cruzada nr. 0, nr.1;
- Estuche plástico.

43400 Jogo de Ferramentas - Kit Lar Tool Set - Home Kit Juego de Herramientas - Kit Hogar

REF.	Peças Pieces Piezas	EAN 789.1114	Embalagem Package Embalaje		
			Un.	KG	Comp x larg x alt Length x width x height Largo x ancho x altura
43400/304	4	01605 5	12	8,50	420 x 300 x 175mm

Composição:

- Martelo de unha 20mm;
- Alicates universal 6" isolada;
- Chave de fenda ponta chata 3/16x4";
- Chave de fenda ponta cruzada 3/16x3".

IPI 8% incluso - NCM: 8205.40.00

Set includes:

- 20mm Claw hammer;
- 6" 1.000V insulated combination pliers;
- Slotted tip screwdriver: 3/16x4";
- Cross recessed tip screwdriver: 3/16x3".

Composición:

- Martillo de uña 20mm;
- Pinza universal aislada 1.000V 6";
- Destornillador punta chata 3/16x4";
- Destornillador punta cruzada 3/16x3".



43406 Jogo de Ferramentas - Kit Eletricista Tool Set - Electrician Kit Juego de Herramientas - Kit Electricista

REF.	Peças Pieces Piezas	EAN 789.1114	Embalagem Package Embalaje		
			Un.	KG	Comp x larg x alt Length x width x height Largo x ancho x altura
43406/507	7	03770 8	10	7,39	490 x 330 x 175mm

Composição:

- Alicates universal 8" isolada;
- 2 Chaves de fenda ponta chata 3/16x4", 1/4x5";
- Chave de fenda ponta cruzada 3/16x4";
- Chave teste;
- Estilete;
- Fita isolante.

IPI 8% incluso - NCM: 8205.40.00

Set includes:

- 8" Combination pliers;
- 2 Slotted tip screwdrivers: 3/16x4" and 1/4x5";
- Cross recessed tip screwdriver: 3/16x4";
- Voltage tester;
- Retractable knife;
- Insulating tape.

Composición:

- Pinza universal 8".
- 2 Destornilladores punta chata: 3/16x4" y 1/4x5";
- Destornillador punta cruzada: 3/16x4";
- Llave test;
- Cortadora;
- Cinta aisladora.





43408 **Jogo de Chaves de Fenda - Basic**
Screwdriver Set - Basic
Juego de Destornilladores - Basic

REF.	Peças Pieces Piezas	EAN 789.1114	Embalagem Package Embalaje		
			Un.	KG	Comp x larg x alt Length x width x height Largo x ancho x altura
43408/115	7	06727 9	12	2,85	335 x 190 x 145mm

Composição:

- 3 Chaves de fenda ponta chata 1/8x3", 3/16x4", 1/4x6";
- 3 Chaves de fenda ponta cruzada 1/8x3", 3/16x3", 3/16x4";
- Chave clip 1/8x3".

IPI 8% incluso - NCM: 8205.40.00

Set includes:

- 3 Slotted tip screwdrivers: 1/8x3", 3/16x4", 1/4x6";
- 3 Cross recessed tip screwdrivers: 1/8x3", 3/16x3", 3/16x4";
- 1 Slotted tip pocket screwdriver: 1/8x3".

Composición:

- 3 Destornilladores punta chata: 1/8x3", 3/16x4", 1/4x6";
- 3 Destornilladores punta cruzada: 1/8x3", 3/16x3", 3/16x4";
- 1 Destornillador clip punta chata: 1/8x3".



43408 **Jogo de Chaves Fixas - Basic**
Open End Wrench Set - Basic
Juego de Llaves Fijas - Basic

REF.	Peças Pieces Piezas	EAN 789.1114	Embalagem Package Embalaje		
			Un.	KG	Comp x larg x alt Length x width x height Largo x ancho x altura
43408/116	3	06725 5	12	1,96	222 x 130 x 110mm

Composição | Set includes | Composición:

- 10x11, 12x13, 14x15mm.

IPI 8% incluso - NCM: 8204.11.00

43408 Jogo de Ferramentas - Basic
Tool Set - Basic
Juego de Herramientas - Basic

REF.	Peças Pieces Piezas	EAN 789.1114	Embalagem Package Embalaje		
			Un.	KG	Comp x larg x alt Length x width x height Largo x ancho x altura
43408/118	4	06728 6	12	2,60	305 x 246 x 150mm

Composição:

- Chave de fenda ponta chata 3/16x3";
- Chave de fenda ponta cruzada 3/16x3";
- Trena 2m;
- Estilete retrátil.

IPI 8% incluso - NCM: 8205.40.00

Set includes:

- Slotted tip screwdriver: 3/16x3";
- Cross recessed tip screwdriver: 3/16x3";
- 2m Measuring tape;
- Retractable knife;

Composición:

- Destornillador punta chata: 3/16x3";
- Destornillador punta cruzada: 3/16x3";
- Cinta métrica 2m;
- Cortadora.



43408 Jogo de Ferramentas - Basic
Tool Set - Basic
Juego de Herramientas - Basic

REF.	Peças Pieces Piezas	EAN 789.1114	Embalagem Package Embalaje		
			Un.	KG	Comp x larg x alt Length x width x height Largo x ancho x altura
43408/122	8	06729 3	12	3,18	380 x 220 x 135mm

Composição:

- Trena 2m;
- Chave emborrachada com 6 ponteiros.

IPI 8% incluso - NCM: 8205.40.00

Set includes:

- 2m Measuring tape;
- Screwdriver with 6 bits.

Composición:

- Cinta métrica 2m;
- Destornillador Llave con 6 punteras





43408 Jogo de Ferramentas - Basic
Tool Set - Basic
Juego de Herramientas - Basic

REF.	Peças Pieces Piezas	EAN 789.1114	Embalagem Package Embalaje		
			Un.	KG	Comp x larg x alt Length x width x height Largo x ancho x altura
43408/500	5	04839 1	12	3,08	435 x 255 x 125mm

Composição:

- 2 Chaves de fenda ponta chata 1/8x4", 3/16x4";
- Chave de fenda ponta cruzada 3/16x4";
- Estilete;
- Trena de 2m.

IPI 8% incluso - NCM: 8205.40.00

Set includes:

- 2 Slotted tip screwdrivers: 1/8x4" and 3/16x4";
- Cross recessed tip screwdriver: 3/16x4";
- Retractable knife;
- 2m Measuring tape.

Composición:

- 2 Destornilladores punta chata: 1/8x4" y 3/16x4";
- Destornillador punta cruzada: 3/16x4";
- Cortadora;
- Cinta métrica 2m.



43408 Jogo de Ferramentas - Basic
Tool Set - Basic
Juego de Herramientas - Basic

REF.	Peças Pieces Piezas	EAN 789.1114	Embalagem Package Embalaje		
			Un.	KG	Comp x larg x alt Length x width x height Largo x ancho x altura
43408/502	5	04856 8	12	3,74	420 x 300 x 175mm

Composição:

- 2 Chaves de fenda ponta chata 1/8x4", 3/16x3";
- Chave de fenda ponta phillips 3/16x4";
- 2 Chaves fixas 10x11, 14x15mm.

IPI 8% incluso - NCM: 8205.40.00

Set includes:

- 2 Slotted tip screwdrivers: 1/8x4" and 3/16x3";
- Cross recessed tip screwdriver: 3/16x4";
- 2 Open end wrenches: 10x11 and 14x15mm.

Composición:

- 2 Destornilladores punta chata: 1/8x4" y 3/16x3";
- Destornillador punta cruzada: 3/16x4";
- 2 Llaves fijas: 10x11 y 14x15mm.

43408 Jogo de Ferramentas Tool Set Juego de Herramientas

REF.	Peças Pieces Piezas	EAN 789.1114	Embalagem Package Embalaje		
			Un.	KG	Comp x larg x alt Length x width x height Largo x ancho x altura
43408/503	3	06043 0	12	2,43	335 x 190 x 145mm

Composição:

- Chave de fenda ponta chata 3/16x4";
- Chave de fenda ponta cruzada 3/16x4";
- Estilete profissional.

IPI 8% incluso - NCM: 8211.93.90

Set includes:

- Slotted tip screwdriver: 3/16x4";
- Cross recessed tip screwdriver: 3/16x4";
- Professional knife.

Composición:

- Destornillador punta chata 3/16x4";
- Destornillador punta cruzada 3/16x4";
- Cortadora profesional.



43408 Jogo de Ferramentas - Basic Tool Set - Basic Juego de Herramientas - Basic

REF.	Peças Pieces Piezas	EAN 789.1114	Embalagem Package Embalaje		
			Un.	KG	Comp x larg x alt Length x width x height Largo x ancho x altura
43408/505	5	03830 9	12	2,54	285 x 320 x 120mm

Composição:

- 2 Chaves de fenda ponta chata 1/8x4", 3/16x3";
- 2 Chaves fixas 8x9, 10x11mm;
- Estilete.

IPI 8% incluso - NCM: 8205.40.00

Set includes:

- 2 Slotted tip screwdrivers: 1/8x4", 3/16x3";
- 2 open end wrenches 8x9, 10x11mm;
- Retractable knife.

Composición:

- 2 Destornilladores punta chata 1/8x4", 3/16x3";
- 2 llaves fijas 8x9, 10x11mm;
- Cortadora.





41192 Jogo de Soquetes 1/4" - Basic
* 1/4" Socket Set - Basic
Juego de Dados 1/4" - Basic

REF.	Peças Pieces Piezas	EAN 789.1114	Embalagem Package Embalaje		
			Un.	KG	Comp x larg x alt Length x width x height Largo x ancho x altura
41192/024	24	06553 4	6	3,10	290 x 130 x 225mm
			12	6,66	310 x 270 x 245mm

Composição:

- 10 soquetes: 4, 5, 6, 7, 8, 9, 10, 11, 12, 13mm;
- Cabo T 1/4";
- Adaptador de 1/4";
- 12 ponteiras:
- 3 ponta chata: 4, 5.5, 6.5mm;
- 3 ponta cruzada: nr. 1, 2, 3;
- 3 ponta hexagonal: 3, 4, 5mm;
- 3 ponta Trafix: T15, T20, T25.

IPI 8% incluso - NCM: 8204.20.00

Set includes:

- 10 Sockets 4, 5, 6, 7, 8, 9, 10, 11, 12, 13mm;
- 1/4" T handle;
- 1/4" Adapter;
- 12 Bits:
- 3 slotted tips 4, 5.5, 6.5mm;
- 3 cross recessed tips nr. 1, 2, 3;
- 3 hexagonal tips 3, 4, 5mm;
- 3 trafix tips T15, T20, T25.

Composición:

- 10 Dados 4, 5, 6, 7, 8, 9, 10, 11, 12, 13mm;
- Mango T 1/4";
- Adaptador 1/4";
- 12 punteras:
- 3 puntas chatas 4, 5.5, 6.5mm;
- 3 puntas cruzadas nr. 1, 2, 3;
- 3 puntas hexagonales 3, 4, 5mm;
- 3 puntas trafix T15, T20, T25.



41180 Jogo de Ferramentas - Basic
Tool Set - Basic
Juego de Herramientas - Basic

REF.	Peças Pieces Piezas	EAN 789.1114	Embalagem Package Embalaje		
			Un.	KG	Comp x larg x alt Length x width x height Largo x ancho x altura
41180/019	8	06280 9	12	7,82	420 x 300 x 175mm

Composição:

- Alicete universal 7";
- Chave de fenda ponta chata 3/16x4";
- Chave de fenda ponta cruzada 3/16x3";
- 2 Chaves fixas 10x11, 12x13mm;
- Estilete;
- Lanterna;
- Embalagem tipo agenda, material sintético.

IPI 8% incluso - NCM: 8204.11.00

Set includes:

- 7" Combination plier;
- Slotted tip screwdriver: 3/16x4";
- Cross recessed tip screwdriver 3/16x3";
- 2 Open end wrenches 10x11, 12x13mm;
- Retractable knife;
- Flashlight;
- Package like agenda made of synthetic material.

Composición:

- Pinza universal 7";
- Destornillador punta chata 3/16x4";
- Destornillador punta cruzada 3/16x3";
- 2 llaves fijas 10x11, 12x13mm;
- Cortadora;
- Linterna;
- Estuche con zipper de material sintético.

41180 Jogo de Ferramentas - Basic
Tool Set - Basic
Juego de Herramientas - Basic

REF.	Peças Pieces Piezas	EAN 789.1114	Embalagem Package Embalaje		
			Un.	KG	Comp x larg x alt Length x width x height Largo x ancho x altura
41180/020	8	06888 7	12	6,73	420 x 300 x 175mm

Composição:

- Alicate universal 7";
- Chave de fenda ponta chata 3/16x3";
- Chave de fenda ponta cruzada 3/16x3";
- 2 Chaves fixas 8x9, 10x11mm;
- Estilete;
- Lanterna;
- Embalagem tipo agenda, material sintético.

IPI 8% incluso - NCM: 8204.11.00

Set includes:

- 7" Combination plier;
- Slotted tip screwdriver: 3/16x3";
- Cross recessed tip screwdriver 3/16x3";
- 2 open end wrenches 8x9, 10x11mm;
- Knife;
- Flashlight;
- Package like agenda made of synthetic material.

Composición:

- Pinza universal 7";
- Destornillador punta chata 3/16x3";
- Destornillador punta cruzada 3/16x3";
- 2 Llaves fijas 8x9, 10x11mm;
- Cortadora;
- Linterna;
- Estuche con zipper de material sintético.



41180 Jogo de Ferramentas - Basic
Tool Set - Basic
Juego de Herramientas - Basic

REF.	Peças Pieces Piezas	EAN 789.1114	Embalagem Package Embalaje		
			Un.	KG	Comp x larg x alt Length x width x height Largo x ancho x altura
41180/101	9	08149 7	12	7,03	390 x 240 x 215mm

Composição:

- Alicate universal 7";
- 2 Chaves de fenda ponta chata 1/8x3", 3/16x3";
- Chave de fenda ponta cruzada 1/8x3";
- 2 Chaves fixas 10x11, 12x13mm;
- Estilete estreito;
- Lanterna;
- Estojo sintético.

- Grátis trena 2m.

IPI 8% incluso - NCM: 8204.11.00

Set includes:

- 7" Combination pliers;
- 2 Slotted tip screwdrivers: 1/8x3", 3/16x3";
- Cross recessed tip screwdriver: 1/8x3";
- 2 Open end wrenches: 10x11, 12x13mm;
- Knife;
- Flashlight;
- Case.

Composición:

- Pinza universal 7";
- 2 Destornilladores punta chata: 1/8x3", 3/16x3";
- Destornillador punta cruzada: 1/8x3";
- 2 Llaves fijas: 10x11, 12x13mm;
- Cortadora;
- Linterna;
- Estuche.





41180 Jogo de Ferramentas - Basic
Tool Set - Basic
Juego de Herramientas - Basic

REF.	Peças Pieces Piezas	EAN 789.1114	Embalagem Package Embalaje		
			Un.	KG	Comp x larg x alt Length x width x height Largo x ancho x altura
41180/102	9	08150 3	12	5,88	420 x 270 x 185mm

Composição:

- Alicates meia cana 5";
- 2 Chaves de fenda ponta chata 1/8x3", 3/16x3";
- Chave de fenda ponta cruzada 1/8x3";
- 2 Chaves fixas 10x11, 12x13mm;
- Estilete estreito;
- Lanterna;
- Estojo sintético.

- Grátis trena 2m.

IPI 8% incluso - NCM: 8204.11.00

Set includes:

- 5" Snipe nose pliers;
- 2 Slotted tip screwdrivers: 1/8x3", 3/16x3";
- Cross recessed tip screwdriver: 1/8x3";
- 2 Open end wrenches 10x11, 12x13mm;
- Knife;
- Flashlight;
- Case.

Composición:

- Pinza punta media cana 5";
- 2 Destornilladores punta chata 1/8x3", 3/16x3";
- Destornillador punta cruzada 1/8x3";
- 2 Llaves fijas 10x11, 12x13mm;
- Cortadora;
- linterna;
- Estuche.



41180 Jogo de Ferramentas - Basic
Tool Set - Basic
Juego de Herramientas - Basic

REF.	Peças Pieces Piezas	EAN 789.1114	Embalagem Package Embalaje		
			Un.	KG	Comp x larg x alt Length x width x height Largo x ancho x altura
41180/103	8	08151 0	12	4,47	465 x 280 x 150mm

Composição:

- Alicates meia cana 5";
- Chave de fenda ponta chata 1/8x3";
- Chave de fenda ponta cruzada 1/8x3";
- 2 Chaves fixas 8x9, 10x11mm;
- Estilete estreito;
- Lanterna;
- Estojo sintético.

IPI 8% incluso - NCM: 8204.11.00

Set includes:

- 5" Snipe nose pliers;
- Slotted tip screwdriver: 1/8x3";
- Cross recessed tip screwdriver: 1/8x3";
- 2 Open end wrenches 8x9, 10x11mm;
- Knife;
- Flashlight;
- Case.

Composición:

- Pinza punta media cana 5";
- Destornillador punta chata 1/8x3";
- Destornillador punta cruzada 1/8x3";
- 2 Llaves fijas 8x9, 10x11mm;
- Cortadora;
- linterna;
- Estuche.

43408 Jogo de Ferramentas - Ideal para carro
Tool Set - Ideal for car
Juego de Herramientas - Ideal para autos

REF.	Peças Pieces Piezas	EAN 789.1114	Embalagem Package Embalaje		
			Un.	KG	Comp x larg x alt Length x width x height Largo x ancho x altura
43408/009	9	02942 0	24	15,51	545 x 355 x 195mm

Composição:

- Alicete universal 7", isolado;
- 2 Chaves de fenda ponta chata 1/8x3", 3/16x4";
- Chave de fenda ponta cruzada 3/16x4";
- 3 Chaves fixas 8x9, 10x11, 12x13mm;
- Estilete.

- Bolsa para guardar as ferramentas.

IPI 8% incluso - NCM: 8204.11.00

Set includes:

- 7" Combination pliers;
- 2 Slotted tip screwdrivers: 1/8x3", 3/16x4";
- Cross recessed tip screwdriver: 3/16x4";
- 3 Open end wrenches: 8x9, 10x11, 12x13mm;
- Retractable knife;
- Small bag.

Composición:

- Pinza universal 7";
- 2 Destornilladores punta chata: 1/8x3", 3/16x4";
- Destornillador punta cruzada: 3/16x4";
- 3 Llaves fijas: 8x9, 10x11 y 12x13mm;
- Cortadora;
- Bolsa.



43408 Jogo de Ferramentas - Basic
Tool Set - Basic
Juego de Herramientas - Basic

REF.	Peças Pieces Piezas	EAN 789.1114	Embalagem Package Embalaje		
			Un.	KG	Comp x larg x alt Length x width x height Largo x ancho x altura
43408/019	9	03606 0	12	8,13	420 x 300 x 175mm

Composição:

- Alicete universal 6", isolado;
- Chave de fenda ponta chata 3/16x3";
- Chave de fenda ponta cruzada 3/16x3";
- Chave de fenda clipe ponta chata 1/8x3";
- 3 Chaves fixas 8x9, 10x11, 12x13mm;
- Estilete;
- Embalagem tipo agenda, material sintético.

IPI 8% incluso - NCM: 8204.11.00

Set includes:

- 6" Combination pliers;
- Slotted tip screwdriver: 3/16x3";
- Cross recessed tip screwdriver: 3/16x3";
- Slotted tip pocket screwdriver: 1/8x3";
- 3 Open end wrenches 8x9, 10x11, 12x13mm;
- Retractable knife;
- Case with zipper.

Composición:

- Pinza universal 6";
- Destornillador punta chata: 3/16x3";
- Destornillador punta cruzada: 3/16x3";
- Destornillador clip punta chata 1/8x3";
- 3 Llaves fijas: 8x9, 10x11, 12x13mm;
- Cortadora;
- Estuche con cremallera.





43408 Jogo de Soquetes e Ponteiras - Basic
* Tool Set - Basic
Juego de Herramientas - Basic

REF.	Peças Pieces Piezas	EAN 789.1114	Embalagem Package Embalaje		
			Un.	KG	Comp x larg x alt Length x width x height Largo x ancho x altura
43408/323	14	07561 8	12	3,97	310 x 290 x 210mm

Composição:

- Chave com encaixe para adaptar ponteiras ou soquetes;
- Adaptador para soquetes 1/4";
- 6 Soquetes sextavados 1/4" em aço carbono: 5, 6, 7, 8, 9, 10mm;
- 3 Ponteiras cruzadas em aço especial nº 1, 2, 3;
- 2 Ponteiras chatas em aço especial 5, 6.5mm;
- Extensão para ponteiras;
- Estojo de metal com zíper e berço em EVA.

IPI 8% incluso - NCM: 8205.40.00

Set includes:

- Screwdriver with plug to adapt bits and sockets;
- 1/4" Socket adapter;
- 6 1/4" six point carbon steel sockets 5, 6, 7, 8, 9, 10mm;
- 3 Cross recessed special steel bits nr.1, nr.2, nr.3;
- 2 Slotted tip special steel bits 5, 6.5mm;
- Extension for bits;
- Compact metal case with zipper and EVA insert.

Composición:

- Llave con encastre para adaptar punteras o dados;
- Adaptador para dados 1/4";
- 6 Dados sextavados 1/4" en acero carbono 5, 6, 7, 8, 9, 10mm;
- 3 Punteras cruzadas en acero especial nº 1, nº 2, nº 3;
- 2 Punteras chatas en acero especial 5, 6.5mm;
- Extension para punteras;
- Estuche metálico con cremallera y inserto en EVA.



43412 Jogo de Ferramentas - Ideal para carro
Tool Set - Ideal for car
Juego de Herramientas - Ideal para autos

REF.	Peças Pieces Piezas	EAN 789.1114	Embalagem Package Embalaje		
			Un.	KG	Comp x larg x alt Length x width x height Largo x ancho x altura
43412/910	10	02956 7	3	4,39	420 x 300 x 175mm

Composição:

- Alicate universal isolada 7";
- 2 Chaves de fenda ponta chata 1/8x3", 3/16x4";
- Chave de fenda ponta cruzada 3/16x4";
- 3 Chaves fixas 8x9, 10x11, 12x13mm;
- Estilete;
- Aspirador de pó para carro 12V.

- Bolsa com dois compartimentos para guardar o aspirador e as ferramentas.

IPI 8% incluso - NCM: 8204.11.00

Set includes:

- 7" Combination plier;
- 2 Slotted tip screwdrivers: 1/8x3", 3/16x4";
- Cross recessed tip screwdriver: 3/16x4";
- 3 Open end wrenches 8x9, 10x11, 12x13mm;
- Retractable knife;
- Car vacuum cleaner;
- Small bag.

Composición:

- Pinza universal aisladora 7";
- 2 Destornilladores punta chata 1/8x3", 3/16x4";
- Destornillador punta cruzada 3/16x4";
- 3 Llaves fijas 8x9, 10x11, 12x13mm;
- Cortadora;
- Aspiradora para auto;
- Bolsa.

43404 Jogo de Ferramentas - Basic
Tool Set - Basic
Juego de Herramientas - Basic

REF.	Peças Pieces Piezas	EAN 789.1114	Embalagem Package Embalaje		
			Un.	KG	Comp x larg x alt Length x width x height Largo x ancho x altura
43404/503	3	00780 0	10	6,14	445 x 280 x 140mm

Composição:

- Martelo de unha 18mm;
- Alicates universal;
- Chave de fenda ponta chata 3/16x4".

IPI 8% incluso - NCM: 8205.40.00

Set includes:

- 20mm Claw hammer;
- 6" Combination pliers;
- Slotted tip screwdriver: 3/16x4".

Composición:

- Martillo uña 20mm;
- Pinza universal 6";
- Destornillador punta chata 3/16x4".

43408 Jogo de Chaves Combinadas - Basic
Combination Wrench Set - Basic
Juego de Llaves Combinadas - Basic

REF.	Peças Pieces Piezas	EAN 789.1114	Embalagem Package Embalaje		
			Un.	KG	Comp x larg x alt Length x width x height Largo x ancho x altura
43408/117	3	06726 2	12	2,46	368 x 190 x 97mm

Composição | Set includes | Composición:

- 10, 11, 12mm.

IPI 8% incluso - NCM: 8204.11.00

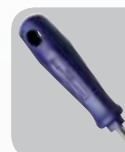

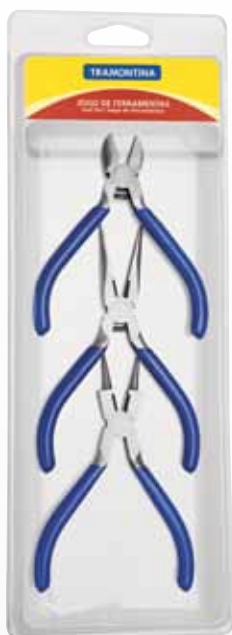

43408 Jogo de Alicates para Bijuteria - Basic
* Pliers Set - Basic
Juego de Pinzas - Basic

REF.	Peças Pieces Piezas	EAN 789.1114	Embalagem Package Embalaje		
			Un.	KG	Comp x larg x alt Length x width x height Largo x ancho x altura
43408/120	3	06899 3	12	2,63	370 x 195 x 100mm

Composição:

- Alicate bico meia cana 5";
- Alicate corte diagonal 4";
- Alicate bico chato 5".

IPI 8% incluso - NCM: 8203.20.10

Composición:

- *Pinza media caña 5";*
- *Pinza corte diagonal 4";*
- *Pinza punta redonda 5".*

Set includes:

- 5" Snipe nose pliers;
- 4" Diagonal cutting pliers;
- 5" Round nose pliers.



43408 Jogo de Ferramentas - Basic
* Tool Set - Basic
Juego de Herramientas - Basic

REF.	Peças Pieces Piezas	EAN 789.1114	Embalagem Package Embalaje		
			Un.	KG	Comp x larg x alt Length x width x height Largo x ancho x altura
43408/123	10	07763 6	12	3,42	425 x 297 x 180mm

Composição:

- Chave emborrachada com 6 ponteiros;
- Trena 2m;
- Lanterna;
- Estilete.

IPI 8% incluso - NCM: 8205.40.00

Set includes:

- Screwdriver with tips;
- 2m Measuring tape;
- Flashlight;
- Retractable knife.

Composición:

- *Destornillador con punteras;*
- *Cinta métrica 2m;*
- *Linterna;*
- *Cortadora.*

43408 Jogo de Ferramentas - Basic
Tool Set - Basic
Juego de Herramientas - Basic

REF.	Peças Pieces Piezas	EAN 789.1114	Embalagem Package Embalaje		
			Un.	KG	Comp x larg x alt Length x width x height Largo x ancho x altura
43408/133	3	07765 0	12	1,78	338 x 308 x 136mm

Composição:

- Chave teste ponta chata 1/8x3";
- Trena 2m;
- Lanterna.

IPI 5% incluso - NCM: 9030.39.90

Set includes:

- Slotted tip voltage tester: 1/8x3";
- 2m Measuring tape;
- Flashlight.

Composición:

- Llave test punta chata 1/8x3";
- Cinta métrica 2m;
- Linterna.

43408 Jogo de Ferramentas - Basic
Tool Set - Basic
Juego de Herramientas - Basic

REF.	Peças Pieces Piezas	EAN 789.1114	Embalagem Package Embalaje		
			Un.	KG	Comp x larg x alt Length x width x height Largo x ancho x altura
43408/142	5	07766 7	12	2,82	425 x 297 x 180mm

Composição:

- Chave de fenda ponta chata 1/8x3";
- Chave de fenda ponta cruzada 1/8x3";
- Chave de fenda clipe ponta chata 1/8x3";
- Trena 2m;
- Lanterna.

IPI 8% incluso - NCM: 8205.40.00

Set includes:

- Slotted tip screwdriver: 1/8x3";
- Cross recessed tip screwdriver: 1/8x3";
- Slotted tip pocket screwdriver: 1/8x3";
- 2m Measuring tape;
- Flashlight.

Composición:

- Destornillador punta chata 1/8x3";
- Destornillador punta cruzada 1/8x3";
- Destornillador clip punta chata 1/8x3";
- Cinta métrica 2m;
- Linterna.

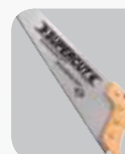



43408 Jogo de Ferramentas - Basic
Tool Set - Basic
Juego de Herramientas - Basic

REF.	Peças Pieces Piezas	EAN 789.1114	Embalagem Package Embalaje		
			Un.	KG	Comp x larg x alt Length x width x height Largo x ancho x altura
43408/143	7	07767 4	12	3,10	425 x 297 x 180mm

Composição:

- 2 Chaves de fenda ponta chata 1/8x3", 3/16x3';
- Chave de fenda ponta cruzada 1/8x3";
- Chaveirinho;
- Trena 2m;
- Estilete estreito;
- Lanterna.

IPI 8% incluso - NCM: 8205.40.00

Set includes:

- 2 Slotted tip screwdrivers: 1/8x3", 3/16x3";
- Cross recessed tip screwdriver: 1/8x3";
- Mini screwdriver;
- 2m Measuring tape;
- Knife;
- Flashlight.

Composición:

- 2 Destornilladores punta chata 1/8x3", 3/16x3";
- Destornillador punta cruzada 1/8x3";
- Mini destornillador;
- Cinta métrica 2m;
- Cortadora;
- Linterna



43408 Jogo de Ferramentas - Basic
Tool Set - Basic
Juego de Herramientas - Basic

REF.	Peças Pieces Piezas	EAN 789.1114	Embalagem Package Embalaje		
			Un.	KG	Comp x larg x alt Length x width x height Largo x ancho x altura
43408/304	4	01626 0	12	2,71	445 x 280 x 140mm

Composição:

- Chave de fenda ponta chata 3/16x3";
- Chave de fenda ponta cruzada 3/16x3";
- Miniarco de serra;
- Estilete.

IPI 8% incluso - NCM: 8205.40.00

Set includes:

- Slotted tip screwdriver: 3/16x3";
- Cross recessed tip screwdriver: 3/16x3";
- Mini hacksaw;
- Retractable knife.

Composición:

- Destornillador punta chata 3/16x3";
- Destornillador punta cruzada 3/16x3";
- Mini arco de sierra;
- Cortadora.

43408 Jogo de Ferramentas - Basic
Tool Set - Basic
Juego de Herramientas - Basic

REF.	Peças Pieces Piezas	EAN 789.1114	Embalagem Package Embalaje		
			Un.	KG	Comp x larg x alt Length x width x height Largo x ancho x altura
43408/306	6	05757 7	12	6,09	435 x 360 x 190mm

Composição:

- Alicates universal 7" isolado;
- 3 Chaves de fenda ponta chata 1/8x4", 3/16x4", 1/4x4";
- Chave de fenda ponta cruzada 3/16x4";
- Estilete.

IPI 8% incluso - NCM: 8205.40.00

Set includes:

- 6" Combination pliers;
- 3 Slotted tip screwdrivers: 1/8x4", 3/16x4", 1/4x4";
- Cross recessed tip screwdriver: 3/16x4";
- Retractable knife.

Composición:

- Pinza universal 6";
- 3 Destornilladores punta chata: 1/8x4", 3/16x4", 1/4x4";
- Destornillador punta cruzada: 3/16x4";
- Cortadora.



43408 Jogo de Ferramentas - Basic
Tool Set - Basic
Juego de Herramientas - Basic

REF.	Peças Pieces Piezas	EAN 789.1114	Embalagem Package Embalaje		
			Un.	KG	Comp x larg x alt Length x width x height Largo x ancho x altura
43408/308	5	05759 1	12	8,67	610 x 360 x 220mm

Composição:

- Martelo de unha 18mm;
- Chave de fenda ponta chata 3/16x4";
- Chave de fenda ponta cruzada 3/16x4";
- Miniarco de serra;
- Trena de 2m.

- Grátis: estojo para guardar as ferramentas.

IPI 8% incluso - NCM: 8205.40.00

Set includes:

- 20mm Claw hammer;
- Slotted tip screwdriver: 3/16x4";
- Cross recessed tip screwdriver: 3/16x4";
- Mini hacksaw;
- 2m Measuring tape.

Composición:

- Martillo de uña 20mm;
- Destornillador punta chata: 3/16x4";
- Destornillador punta cruzada: 3/16x4";
- Mini arco de sierra;
- Cinta métrica 2m.

- Free: case to store the tools.

- Gratis: estuche para almacenar las herramientas.

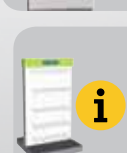
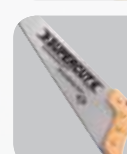



43410 Jogo de Ferramentas Tool Set Juego de Herramientas

REF.	Peças Pieces Piezas	EAN 789.1114	Embalagem Package Embalaje		
			Un.	KG	Comp x larg x alt Length x width x height Largo x ancho x altura
43410/030	30	01459 4	3	12,25	460 x 350 x 350mm

Composição:

- Martelo de unha 20mm;
- Alicata bomba d'água 10";
- Alicata universal 6";
- Alicata corte diagonal 6", isolado;
- 5 Chaves de fenda ponta chata 1/8x3", 3/16x3", 3/16x5", 1/4x4", 1/4x6";
- Chave de fenda toco ponta chata 3/16x1.1/2";
- 2 Chaves de fenda ponta cruzada 3/16x3" e 1/4x4";
- Chave de fenda toco ponta cruzada 3/16x1.1/2";
- Chave de fenda para eletrônica ponta chata 1/8x6";
- Chave teste;
- Chaveirinho;
- 7 Chaves fixas 6x7, 8x9, 10x11, 12x13, 14x15, 16x17 e 18x19mm;
- Nível plástico 230mm;
- Esquadro 250mm;
- Trena de 2m;
- Miniarco de serra;
- Formão cabo plástico 1/2";
- Estilete;
- Canivete;
- Acompanha 6 buchas e 6 parafusos.
- Acompanha maleta.

IPI 8% incluso - NCM: 8205.40.00

Set includes:

- 20mm Claw hammer;
- 10" Water pump pliers;
- 6" Combination pliers;
- 6" Diagonal cutting pliers;
- 5 Slotted tip screwdrivers: 1/8x3", 3/16x3", 3/16x5", 1/4x4", 1/4x6";
- Slotted tip stubby type screwdriver: 3/16x1.1/2";
- 2 Cross recessed tip screwdrivers: 3/16x3", 1/4x4";
- Cross recessed tip stubby type screwdriver: 3/16x1.1/2";
- Slotted tip electronic screwdriver 1/8x6";
- Voltage tester;
- Mini screwdriver;
- 7 Open end wrenches: 6x7, 8x9, 10x11, 12x13, 14x15, 16x17, 18x19mm;
- Plastic level;
- 250mm Square;
- 2m Measuring tape;
- Mini hacksaw;
- 1/2" Wood chisel;
- Retractable knife;
- Pocket knife;
- 6 Rawl plugs;
- 6 Screws.

Composición:

- Martillo de uña 20mm;
- Pinza pico loro 10";
- Pinza universal 6";
- Pinza corte diagonal 6";
- 5 Destornilladores punta chata: 1/8x3", 3/16x3", 3/16x5", 1/4x4", 1/4x6";
- Destornillador corto punta chata: 3/16x1.1/2";
- 2 Destornilladores punta cruzada: 3/16x3", 1/4x4";
- Destornillador corto punta cruzada: 3/16x1.1/2";
- Destornillador para electrónica punta chata: 1/8x6";
- Llave test;
- Mini destornillador;
- 7 Llaves fijas: 6x7, 8x9, 10x11, 12x13, 14x15, 16x17, 18x19mm;
- Nivel de plástico;
- Escuadra 250mm;
- Cinta métrica 2m;
- Mini arco de sierra;
- Formón 1/2";
- Cortadora retráctil;
- Corta plumas;
- 6 Buchas;
- 6 Tornillos.

41191 Jogo de Ferramentas - Basic
Tool Set - Basic
Juego de Herramientas - Basic

REF.	Peças Pieces Piezas	EAN 789.1114	Embalagem Package Embalaje		
			Un.	KG	Comp x larg x alt Length x width x height Largo x ancho x altura
41191/040	41	06917 4	3	5,17	390 x 230 x 220mm

Composição:

- Martelo de unha 18mm;
- Alicates universal 7";
- Estilete;
- Trena 2m;
- Chave emborrachada com adaptador 1/4";
- 10 soquetes: 4, 5, 6, 7, 8, 9, 10, 11, 12, 13mm;
- 25 ponteiras, sendo:
 - 4 pontas chata: 3, 4, 5, 6.5mm;
 - 5 pontas cruzada: nº 0, 1, 2, 3, 4;
 - 5 pontas hexagonal: 2, 3, 4, 5, 6mm;
 - 6 pontas Trafrix: T10, T15, T20, T25, T30, T40;
 - 5 pontas pozidrive: PZ0, PZ1, PZ2, PZ3, PZ4.
- Acompanha maleta.

IPI 8% incluso - NCM: 8205.40.00

Set includes:

- 18mm Claw hammer;
- 7" Combination pliers;
- Knife;
- 2m measuring tape;
- Screwdriver with 1/4" square drive;
- 10 sockets: 4, 5, 6, 7, 8, 9, 10, 11, 12 and 13mm;
- 25 tips:
 - 4 slotted tips: 3, 4, 5, 6.5mm;
 - 5 cross recessed tips: nº 0, 1, 2, 3, 4;
 - 5 hexagonal tips: 2, 3, 4, 5, 6mm;
 - 6 Trafrix tips: T10, T15, T20, T25, T30, T40;
 - 5 Pozidrive tips: PZ0, PZ1, PZ2, PZ3, PZ4.

Composición:

- Martillo de uña 18mm;
- Pinza universal 7";
- Cortadora;
- Cinta métrica 2m;
- Destornillador con encastre de 1/4";
- 10 dados: 4, 5, 6, 7, 8, 9, 10, 11, 12, 13mm;
- 25 punteras:
 - 4 puntas chatas: 3, 4, 5, 6.5mm;
 - 5 puntas cruzadas: nº 0, 1, 2, 3, 4;
 - 5 puntas hexagonales: 2, 3, 4, 5, 6mm;
 - 6 puntas Trafrix: T10, T15, T20, T25, T30, T40;
 - 5 puntas Pozidrive: PZ0, PZ1, PZ2, PZ3, PZ4.

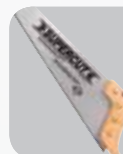
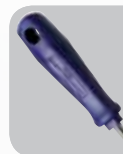



43600 Jogo de Soquetes 1/2"
* 1/2" Socket Set
Juego de Dados 1/2"

REF.	Peças Pieces Piezas	EAN 789.1114	Embalagem Package Embalaje		
			Un.	KG	Comp x larg x alt Length x width x height Largo x ancho x altura
43600/022	22	089882	3	8,71	390 x 240 x 215mm

Soquetes e acessórios forjados em aço cromo vanádio e temperados.

Composição:

- 18 soquetes estriados: 8, 9, 10, 11, 12, 13, 14, 15, 16, 17, 18, 19, 21, 22, 24, 27, 30, 32 mm.
- Catraca reversível de 1/2"
- Cabo T 10"
- Extensão 10"
- Extensão 5"
- Acompanha maleta.

IPI 8% incluso - NCM: 8204.20.00

ÃO CROMO VANÁDIO
Chrome Vanadium Steel • Acero Cromo Vanadio

Chrome vanadium sockets and accessories forged and tempered.

Dados y accesorios forjados y templados en acero cromo vanadio.

Set includes:

- 18 twelve point sockets: 8, 9, 10, 11, 12, 13, 14, 15, 16, 17, 18, 19, 21, 22, 24, 27, 30, 32 mm.
- 1/2" ratchet
- 10" T handle
- 5" and 10" extensions
- Plastic case

Composición:

- 18 dados estriados: 8, 9, 10, 11, 12, 13, 14, 15, 16, 17, 18, 19, 21, 22, 24, 27, 30, 32 mm.
- Matraca e 1/2"
- Mango T de 10"
- Extensiones de 5" y 10"
- Maletín plástico



41181 Jogo de Ferramentas - Basic
Tool Set - Basic
Juego de Herramientas - Basic

REF.	Peças Pieces Piezas	EAN 789.1114	Embalagem Package Embalaje		
			Un.	KG	Comp x larg x alt Length x width x height Largo x ancho x altura
41181/007	7	06886 3	3	2,17	320 x 285 x 212mm

Composição:

- Alicates universal 7";
- Chave de fenda ponta chata 3/16x3";
- Chave de fenda ponta cruzada 3/16x3";
- 2 Chaves fixas 10x11 e 12x13mm;
- Estilete;
- Lanterna.
- Acompanha maleta.

IPI 8% incluso - NCM: 8204.11.00

Set includes:

- 7" Combination pliers;
- Slotted tip screwdriver: 3/16x3";
- Cross recessed tip screwdriver: 3/16x3";
- 2 Open end wrenches 10x11, 12x13mm;
- Knife;
- Flashlight.

Composición:

- Pinza universal 7";
- Destornillador punta chata 3/16x3";
- Destornillador punta cruzada 3/16x3";
- 2 Llaves fijas 10x11, 12x13mm;
- Cortadora;
- linterna.

43411 Jogo de Ferramentas - Basic Tool Set - Basic Juego de Herramientas - Basic

REF.	Peças Pieces Piezas	EAN 789.1114	Embalagem Package Embalaje		
			Un.	KG	Comp x larg x alt Length x width x height Largo x ancho x altura
43411/007	7	05350 0	6	2,91	435 x 255 x 125mm

Composição:

- 2 Chaves de fenda ponta chata 1/8x3", 3/16x4";
- Chave de fenda ponta cruzada 3/16x3";
- 2 Chaves fixas 10x11, 12x13mm;
- Estilete;
- Luvas.
- Acompanha maleta.

IPI 8% incluso - NCM: 8205.40.00

Set includes:

- 3 Screwdrivers slotted tip: 1/8x3", 3/16x3", 3/16x4";
- 2 Open end wrenches: 10x11, 12x13mm;
- Retractable knife;
- Gloves;
- Plastic case.

Composición:

- 3 Destornilladores punta chata: 1/8x3", 3/16x3", 3/16x4";
- 2 Llaves fijas: 10x11 y 12x13mm;
- Cortadora;
- Guantes;
- Incluye maletín.



43900 Jogo de Ferramentas Tool Set Juego de Herramientas

REF.	Peças Pieces Piezas	EAN 789.1114	Embalagem Package Embalaje		
			Un.	KG	Comp x larg x alt Length x width x height Largo x ancho x altura
43900/586	11	04384 6	2	2,79	285 x 320 x 120mm

Composição:

- Martelo de unha 20mm;
- Alicates universal 7";
- 2 Chaves de fenda ponta chata 3/16x4", 1/4x5";
- 2 Chaves de fenda ponta cruzada 1/8x3", 3/16x4";
- 4 Chaves combinadas 10, 11, 12, 13mm;
- Miniarco de serra.

- Grátis caixa plástica.

IPI 8% incluso - NCM: 8204.11.00

Set includes:

- 20mm Claw hammer;
- 7" Combination pliers;
- 2 Slotted tip screwdrivers: 3/16x4", 1/4x5";
- 2 Cross recessed tip screwdrivers: 1/8x3", 3/16x4";
- 4 Combination wrenches: 10, 11, 12, 13mm;
- Mini hacksaw.

- Free: plastic case.

Composición:

- Martillo de uña 20mm;
- Pinza universal 7";
- 2 Destornilladores punta chata: 3/16x4", 1/4x5";
- 2 Destornilladores punta cruzada: 1/8x3", 3/16x4";
- 4 Llaves combinadas: 10, 11, 12, 13mm;
- Mini arco de sierra.

- Incluye: Maletín plástico.

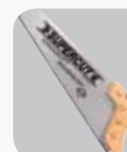



43408 Pote de Mini Chave de Fenda Colorida - Basic
Mini Screwdriver Pot - Basic
Pote con Mini Destornilladores - Basic

REF.	Peças Pieces Piezas	EAN 789.1114	Embalagem Package Embalaje		
			Un.	KG	Comp x larg x alt Length x width x height Largo x ancho x altura
43408/900	120	05998 4	1x120	1,39	140 x 140 x 130mm
			1x240	2,94	365 x 170 x 135mm

Composição:

- 120 Mini chaves de fenda.
- Código de barras individual.
- 1x240 equivale a 2 potes com 120 mini chaves de fenda cada.

IPI 8% incluso - NCM: 8205.40.00

Set includes:

- 120 Mini screwdrivers with individual barcodes.

Composición:

- 120 Mini destornilladores con código de barras individual.

1 x 240: 2 plastics pots with 120 pices each
2 potes plasticos con 120 piezas cada

43408 Pote de Trens 2m - Basic
* 2m Measuring Tape Pot - Basic
Pote con Cintas Métricas 2m - Basic



REF.	Peças Pieces Piezas	EAN 789.1114	Embalagem Package Embalaje		
			Un.	KG	Comp x larg x alt Length x width x height Largo x ancho x altura
43408/901	24	05999 1	1x24	1,94	160 x 160 x 260mm
			1x48	4,77	420 x 300 x 175mm

Composição:

- 24 trenas de 2m.
- Código de barras individual.
- 1x48 equivale a 2 potes com 24 trenas cada.

IPI 15% incluso - NCM: 9017.80.90

Set includes:

- 24 2m measuring tape with individual barcodes.

Composición:

- 24 Cintas métricas 2m con código de barras individual.

1 x 48: 2 plastics pots with 24 pices each
2 potes plasticos con 24 piezas cada

43408 Pote de Estilete - Basic
* **Knife Pot - Basic**
Pote con Cortadoras - Basic

REF.	Peças Pieces Piezas	EAN 789.1114	Embalagem Package Embalaje		
			Un.	KG	Comp x larg x alt Length x width x height Largo x ancho x altura
43408/902	24	06000 3	1x24	0,92	160 x 160 x 260mm
			1x48	2,27	420 x 300 x 175mm

Composição:

- 24 estiletos.
- Código de barras individual.
- 1x48 equivale a 2 potes com 24 estiletos cada.

IPI 12% incluso - NCM: 8211.93.90

Set includes:

- 24 Knives with individual barcodes.

Composición:

- 24 Piezas de cortadoras con código de barras individual.

1 x 48: 2 plastics pots with 24 pices each
2 potes plasticos con 24 piezas cada

43408 Pote de Miniarco de Serra Colorido - Basic
Mini Hacksaw Pot - Basic
Pote con Mini Arcos de Sierra - Basic

REF.	Peças Pieces Piezas	EAN 789.1114	Embalagem Package Embalaje		
			Un.	KG	Comp x larg x alt Length x width x height Largo x ancho x altura
43408/904	12	06002 7	1x12	0,65	120 x 120 x 280mm
			1x24	1,54	380 x 220 x 135mm

Composição:

- 12 miniarcos de serra.
- Código de barras individual.
- 1x24 equivale a 2 potes com 12 miniarcos de serra cada.

IPI 8% incluso - NCM: 8202.10.00

Set includes:

- 12 Mini hacksaw with individual barcodes.

Composición:

- 12 mini arcos de sierra con código de barras individuales.

1 x 24: 2 plastics pots with 12 pices each
2 potes plasticos con 12 piezas cada

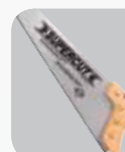



43408 Jogo de Ferramentas Tool Set Juego de Herramientas

REF.	Peças Pieces Piezas	EAN 789.1114	Embalagem Package Embalaje		
			Un.	KG	Comp x larg x alt Length x width x height Largo x ancho x altura
43408/906	10	06003 4	1	1,05	120 x 120 x 280mm
			6	6,79	395 x 295 x 280mm

Composição:

- Martelo de unha 20mm;
- Alicata universal 7";
- 2 Chaves de fenda ponta chata 1/8x3", 3/16x4";
- Chave de fenda ponta cruzada 3/16x4";
- Trena de 2m;
- Estilete;
- Lanterna;
- Plug T;
- Luva.

IPI 8% incluso - NCM: 8205.40.00

Set includes:

- 20mm claw hammer;
- 7" Universal pliers;
- 2 Slotted tip screwdrivers: 1/8x3", 3/16x4";
- Cross recessed tip screwdriver: 3/16x4";
- 2m Measuring tape;
- Retractable knife;
- Flashlight;
- T plug;
- Gloves.

Composición:

- Martillo de uña 20mm;
- Pinza universal 7";
- 2 Destornilladores punta chata 1/8x3", 3/16x4";
- Destornillador punta cruzada 3/16x4";
- Cinta métrica 2m;
- Cortadora;
- linterna;
- Plug T;
- Guantes.



43408 Pote de Chave Teste Voltage Tester Pot Pote con Llaves Test

REF.	Peças Pieces Piezas	EAN 789.1114	Embalagem Package Embalaje		
			Un.	KG	Comp x larg x alt Length x width x height Largo x ancho x altura
43408/907	60	06004 1	1x60	1,51	150 x 150 x 175mm
			1x120	3,32	400 x 245 x 140mm

Composição:

- 60 chaves teste.

• Código de barras individual.

• 1x120 equivale a 2 potes com 60 chaves teste cada.

IPI 5% incluso - NCM: 9030.39.90

Set includes:

- 60 Voltage tester with individual barcodes.

Composición:

- 60 Llaves test con código de barras individual.

1 x 120: 2 plastics pots with 60 pices each
2 potes plasticos con 60 piezas cada

43408 Pote de Chave de Fenda Colorida - Ponta chata
Screwdrivers Pot - Slotted tip
Pote con Destornilladores - Punta chata



REF.	Peças Pieces Piezas	EAN 789.1114	Embalagem Package Embalaje		
			Un.	KG	Comp x larg x alt Length x width x height Largo x ancho x altura
43408/908	60	06025 6	1x60	2,39	160 x 160 x 260mm
			1x120	5,16	420 x 300 x 175mm

Composição:

- 60 chaves de fenda ponta chata 3/16x4".
- Código de barras individual.
- 1x120 equivale a 2 potes com 60 chaves de fenda cada.

IPI 8% incluso - NCM:8205.40.00

Set includes:

- 60 Slotted tip screwdrivers 3/16x4" with individual barcodes.

Composición:

- 60 Destornilladores punta chata 3/16x4" con código de barras individual.

1 x 120: 2 plastics pots with 60 pices each
2 potes plasticos con 60 piezas cada

43408 Pote de Chave de Fenda Colorida - Ponta cruzada
Screwdrivers Pot - Cross recessed tip
Pote con Destornilladores - Punta cruzada



REF.	Peças Pieces Piezas	EAN 789.1114	Embalagem Package Embalaje		
			Un.	KG	Comp x larg x alt Length x width x height Largo x ancho x altura
43408/910	60	06026 3	1x60	2,40	160 x 160 x 260mm
			1x120	5,18	420 x 300 x 175mm

Composição:

- 60 chaves de fenda ponta cruzada 3/16x4".
- Código de barras individual.
- 1x120 equivale a 2 potes com 60 chaves de fenda cada.

IPI 8% incluso - NCM:8205.40.00

Set includes:

- 60 Cross recessed tip screwdrivers 3/16x4" with individual barcodes.

Composición:

- 60 Destornilladores punta cruzada 3/16x4" con código de barras individual.

1 x 120: 2 plastics pots with 60 pices each
2 potes plasticos con 60 piezas cada

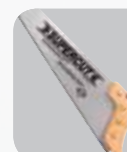

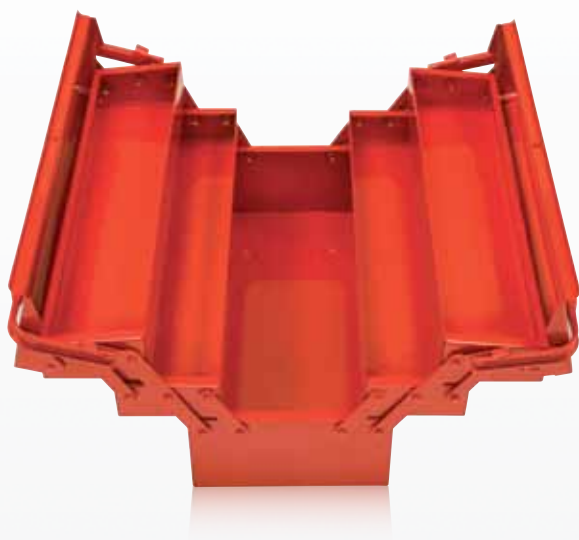

43800 Caixa Sanfonada - 5 gavetas
Tool Box - 5 drawers
Caja Porta Herramientas - 5 cajones

REF.	EAN 789.1114	Embalagem Package Embalaje			Dimensões Dimensions (mm)		
		Un.	KG	Comp x larg x alt Length x width x height Largo x ancho x altura	A	B	C
43800/001	06757 6	1	4,28	475 x 240 x 250mm	320	414	195

Corpo em aço carbono.
Pintura eletrostática a pó.
Alças flexíveis.

IPI 5% incluso - NCM: 7326.90.90

Carbon steel body.
Electrostatic painting.
Flexible handles.

*Cuerpo en acero carbono.
Pintura electrostática.
Alzas flexibles.*

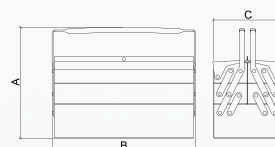

43800 Caixa Sanfonada - 3 gavetas
Tool Box - 3 drawers
Caja Porta Herramientas - 3 cajones

REF.	EAN 789.1114	Embalagem Package Embalaje			Dimensões Dimensions (mm)		
		Un.	KG	Comp x larg x alt Length x width x height Largo x ancho x altura	A	B	C
43800/002	06758 3	1	3,43	440 x 220 x 212mm	275	414	195

Corpo em aço carbono.
Pintura eletrostática a pó.
Alças flexíveis.

IPI 5% incluso - NCM: 7326.90.90

Carbon steel body.
Electrostatic painting.
Flexible handles.

*Cuerpo en acero carbono.
Pintura electrostática.
Alzas flexibles.*

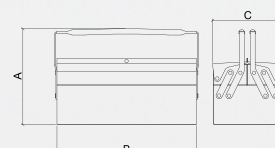

43800 Baú
Tool Box
Caja Porta Herramientas

REF.	EAN 789.1114	Embalagem Package Embalaje			Dimensões Dimensions (mm)		
		Un.	KG	Comp x larg x alt Length x width x height Largo x ancho x altura	A	B	C
43800/003	06759 0	1	2,07	410 x 180 x 180mm	165	400	160

Corpo em aço carbono.
Pintura eletrostática a pó.

IPI 5% incluso - NCM: 7326.90.90

Carbon steel body.
Electrostatic painting.

*Cuerpo en acero carbono.
Pintura electrostática.*

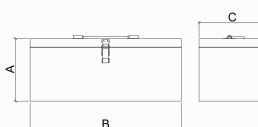

43409 Cinto para Ferramentas
Contractors (or Plumbers) Tool Belt
*Cinturón Porta Herramientas para
Carpintero (o Plomero)*

REF.	EAN 789.1114	Embalagem Package Embalaje			Dimensões Dimensions (mm)		
		Un.	KG	Comp x larg x alt Length x width x height Largo x ancho x altura	A	B	C
43409/001	07649 3	1	0,24	260 x 160 x 65mm	125	418	230

Corpo em couro curtido com espessura de 2,5mm.
Cinto de náilon reforçado.
Fechamento do cinto em plástico.

IPI 10% incluso - NCM:4203.30.00

Leather belt with 2.5mm thickness.
Nylon strap.
Plastic buckle.

*Cuerpo en cuero con 2,5mm de espesor.
Cinturón de nylon.
Cierre en plástico.*

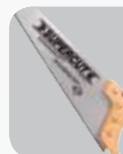
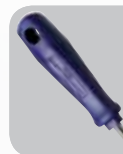
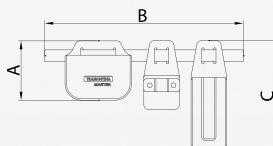



43409 Cinto para Ferramentas
Tool Belt
Cinturón Porta Herramientas

REF.	EAN 789.1114	Embalagem Package Embalaje			Dimensões Dimensions (mm)	
		Un.	KG	Comp x larg x alt Length x width x height Largo x ancho x altura	A	B
43409/012	09412 1	1	0,7	350 x 290 x 100mm	660	250

Corpo e cinto fabricados em poliéster.
Engates plásticos para melhor fechamento do cinto.
2 suportes externos em couro para ferramentas diversas.
12 bolsos.

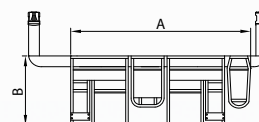

IPI 10% incluso - NCM:4203.30.00

Body and belt made in polyester.
Plastic hooks for better closure of the belt.
2 external leather supports for several tools.
12 pockets.



*Cuerpo y cinturón fabricados en poliéster.
Acoplamiento de plástico para un mejor cierre de lo cinturón.
2 soportes externos de cuero para herramientas variadas.
12 bolsillos.*



43409 Cinto para Ferramentas
Tool Belt
Cinturón Porta Herramientas

REF.	EAN 789.1114	Embalagem Package Embalaje			Dimensões Dimensions (mm)	
		Un.	KG	Comp x larg x alt Length x width x height Largo x ancho x altura	A	B
43409/014	09413 8	1	0,68	280 x 270 x 120mm	260	335

Corpo e cinto fabricados em poliéster.
Engates plásticos para melhor fechamento do cinto.
2 suportes metálicos externos para ferramentas diversas.
14 bolsos.

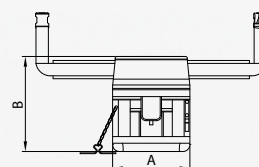

IPI 10% incluso - NCM:4203.30.00

Body and belt made in polyester.
Plastic hooks for better closure of the belt.
2 external metallic supports for several tools.
14 pockets.



*Cuerpo y cinturón fabricados en poliéster.
Acoplamiento de plástico para un mejor cierre de lo cinturón.
2 soportes externos metálicos para herramientas variadas.
14 bolsillos.*

43801 Bolsa para Ferramentas Tool Bag Bolsa Porta Herramientas

REF.	EAN 789.1114	Embalagem Package Embalaje			Dimensões Dimensions (mm)		
		Un.	KG	Comp x larg x alt Length x width x height Largo x ancho x altura	A	B	C
43801/022	09416 9	1	2	420 x 350 x 250mm	380	260	210

Bolsa e alça de ombro fabricados em poliéster.
Alça de ombro com engates metálicos gerando maior resistência.
Cabo em estrutura metálica tubular, com empunhadura de borracha e fixado por parafusos e porcas.
22 bolsos.

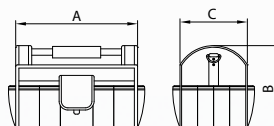

IPI 10% incluso - NCM: 4202.29.00

Body and shoulder strap made in polyester.
Shoulder strap with metal hooks to generate more resistance.
Steel tubular handle with rubber grip, fixed with screws and nuts.
22 pockets.

*Cuerpo y bandolera fabricados en poliéster.
Bandolera con enganche metálico para generar una mayor resistencia.
Cable en acero tubular, con empuñadura de goma y fijado por pernos y tuercas.
22 bolsillos.*

43801 Bolsa para Ferramentas Tool Bag Bolsa Porta Herramientas

REF.	EAN 789.1114	Embalagem Package Embalaje			Dimensões Dimensions (mm)		
		Un.	KG	Comp x larg x alt Length x width x height Largo x ancho x altura	A	B	C
43801/040	09417 6	1	2,22	500 x 200 x 280mm	500	285	260

Bolsa e alça de ombro fabricados em poliéster.
Alça de ombro com engates metálicos gerando maior resistência.
Cabo em estrutura metálica tubular, com empunhadura de borracha e fixado por parafusos e porcas.
Bolsos laterais fechados por zíper para armazenamento mais seguro das ferramentas.
40 bolsos.

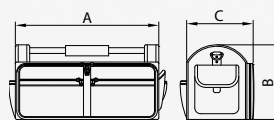

IPI 10% incluso - NCM: 4202.29.00

Body and shoulder strap made in polyester.
Shoulder strap with metal hooks to generate more resistance.
Steel tubular handle with rubber grip, fixed with screws and nuts.
Side pockets with zipper for safer storage.
40 pockets.

*Cuerpo y bandolera fabricados en poliéster.
Bandolera con enganche metálico para generar una mayor resistencia.
Cable en acero tubular, con empuñadura de goma y fijado por pernos y tuercas.
Bolsillos laterales con cremallera para un almacenamiento seguro de las herramientas.
40 bolsillos.*

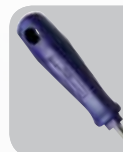



MATERIAIS DE CONSUMO CONSUMABLES CONSUMIBLES



43121 Bolha para Nível (Ampola)

* Vial for Level
Burbuja para Nivel



REF.	Tamanho Size <i>Tamaño</i>	EAN 789.1114	Embalagem Package <i>Embalaje</i>			Dimensões Dimensions (mm)	
			Un.	KG	Comp x larg x alt Length x width x height <i>Largo x ancho x altura</i>	A	B
43121/000	9,5 x 35mm	01206 4	12	0,05	165 x 70 x 30mm	9,5	35
			60	0,18	220 x 95 x 45mm		

Pode ser usada em todos os modelos de níveis Tramontina.
Leitura de 360°.

IPI 15% incluso - NCM: 9033.00.00

Suitable for all Tramontina levels.
360° reading.

*Puede ser usada en todos los modelos de niveles Tramontina.
Lectura de 360°.*

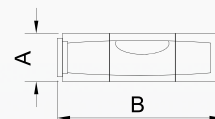

41700 Lima para Serrote - Basic

* Saw File - Basic
Lima para Serrucho - Basic



REF.	Tamanho Size <i>Tamaño</i>	EAN 789.1114	Embalagem Package <i>Embalaje</i>			Dimensões Dimensions (mm)			
			Un.	KG	Comp x larg x alt Length x width x height <i>Largo x ancho x altura</i>	A	B	C	D
EMBALAGEM CLAM PACK									
41700/306	6"	05553 5	12	1,48	355 x 125 x 195mm	6,2	265	34	23
			72	9,75	375 x 375 x 405mm				

Corpo em aço carbono temperado.
Cabo injetado.

IPI 8% incluso - NCM: 8203.10.10

Hardened carbon steel body.
Injected handle.

*Cuerpo en acero carbono templado.
Mango inyectado.*

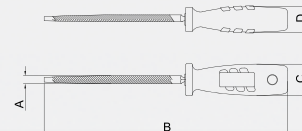

41701 Lima Redonda Bastarda - Basic
* **Round File - Basic**
Lima Redonda Bastarda - Basic

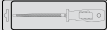
REF.	Tamanho Size <i>Tamaño</i>	EAN 789.1114	Embalagem Package <i>Embalaje</i>			Dimensões Dimensions (mm)			
			Un.	KG	Comp x larg x alt Length x width x height <i>Largo x ancho x altura</i>	A	B	C	D
EMBALAGEM CLAM PACK 									
41701/308	8"	05105 6	12	1,72	340 x 125 x 195mm	8	315	34	23
			72	11,40	425 x 380 x 190mm				

Corpo em aço carbono temperado.
Cabo injetado.

IPI 8% incluso - NCM: 8203.10.10

Hardened carbon steel body.
Injected handle.

*Cuerpo en acero carbono templado.
Mango inyectado.*

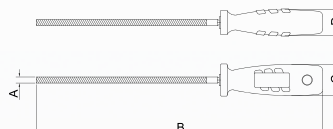

41702 Lima para Enxada - Basic
* **Hoe Mill File - Basic**
Lima para Azada - Basic

REF.	Tamanho Size <i>Tamaño</i>	EAN 789.1114	Embalagem Package <i>Embalaje</i>			Dimensões Dimensions (mm)			
			Un.	KG	Comp x larg x alt Length x width x height <i>Largo x ancho x altura</i>	A	B	C	D
EMBALAGEM CLAM PACK 									
41702/308	8"	05106 3	12	2,45	396 x 125 x 190mm	20	320	34	23
			72	15,89	425 x 380 x 410mm				

Corpo em aço carbono temperado.
Cabo injetado.

IPI 8% incluso - NCM: 8203.10.10

Hardened carbon steel body.
Injected handle.

*Cuerpo en acero carbono templado.
Mango inyectado.*

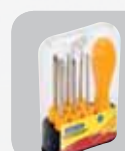
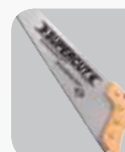
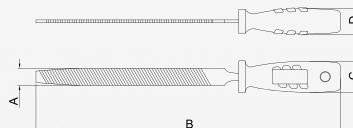

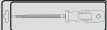

41710 **Grosa Meia Cana - Basic**
* **Half Round Rasp File - Basic**
Escofina Media Caña - Basic

REF.	Tamanho Size <i>Tamaño</i>	EAN 789.1114	Embalagem Package <i>Embalaje</i>			Dimensões Dimensions (mm)			
			Un.	KG	Comp x larg x alt Length x width x height <i>Largo x ancho x altura</i>	A	B	C	D
EMBALAGEM CLAM PACK 									
41710/310	10"	05107 0	12	3,45	455 x 125 x 190mm	23	370	34	23
			72	21,22	470 x 380 x 400mm				

Corpo em aço carbono temperado.
Cabo injetado.

IPI 8% incluso - NCM: 8203.10.10

Hardened carbon steel body.
Injected handle.

Cuerpo en acero carbono templado.
Mango inyectado.

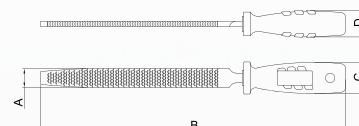

41711 **Grosa Redonda - Basic**
* **Round Rasp File - Basic**
Escofina Redonda - Basic

REF.	Tamanho Size <i>Tamaño</i>	EAN 789.1114	Embalagem Package <i>Embalaje</i>			Dimensões Dimensions (mm)			
			Un.	KG	Comp x larg x alt Length x width x height <i>Largo x ancho x altura</i>	A	B	C	D
EMBALAGEM CLAM PACK 									
41711/310	10"	05108 7	12	2,41	455 x 100 x 295mm	9	360	34	23
			72	16,35	620 x 475 x 310mm				

Corpo em aço carbono temperado.
Cabo injetado.

IPI 8% incluso - NCM: 8203.10.10

Hardened carbon steel body.
Injected handle.

Cuerpo en acero carbono templado.
Mango inyectado.

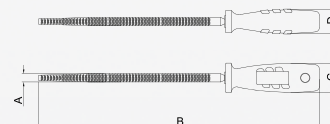

43390 Lâminas para Estiletes
* Knifes Blade
Lâmina para Cortadoras

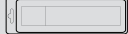
REF.	Peças Pieces Piezas	EAN 789.1114	Embalagem Package Embalaje			Dimensões Dimensions (mm)		
			Un.	KG	Comp x larg x alt Length x width x height Largo x ancho x altura	A	B	C
EMBALAGEM CLAM PACK 								
43390/500	10 un.	05180 3	50	4,11	250 x 220 x 135mm	114	22	9
			200	16,99	460 x 275 x 290mm			

Lâmina em aço carbono temperado.
Acompanha estojo plástico para armazenamento.
Própria para todos os estiletes Tramontina.

IPI 10% incluso - NCM: 8211.94.00

Hardened carbon steel blade.
With plastic case for storage.
Suitable for all Tramontina models.

Lâmina en acero carbono templado.
Acompaña embalaje plástica para almacenamiento.
Propia para todos los cortadores Tramontina.

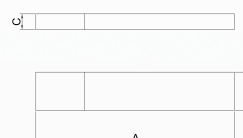

43370 Lâmina para Plaina
Replacement Blade
Lâmina para Cepillo

REF.	Tamanho Size Tamaño	EAN 789.1114	Embalagem Package Embalaje			Dimensões Dimensions (mm)		
			Un.	KG	Comp x larg x alt Length x width x height Largo x ancho x altura	A	B	C
43370/302		00292 8	12	1,40	345 x 90 x 95mm	110	43	3

Aço cromo vanádio.
Própria para plaina 43350.

IPI 8% incluso - NCM: 8205.30.00

Chrome vanadium steel body.
Suitable for plane 43350.

Cuerpo en acero cromo vanadio.
Propia para cepillo 43350.

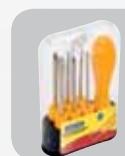
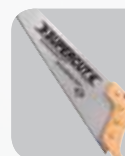
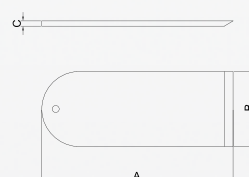



43370 Lâmina para Plaina
Replacement Blade
Lámina para Cepillo

REF.	Tamanho Size <i>Tamaño</i>	EAN 789.1114	Embalagem Package <i>Embalaje</i>			Dimensões Dimensions (mm)		
			Un.	KG	Comp x larg x alt Length x width x height <i>Largo x ancho x altura</i>	A	B	C
43370/303		00293 5	12	1,67	343 x 175 x 92mm	53	98	21

Aço cromo vanádio.
Própria para plaina 43352.

IPI 8% incluso - NCM: 8205.30.00

Chrome vanadium steel body.
Suitable for plane 43352.

*Cuerpo en acero cromo vanadio.
Propia para cepillo 43352.*

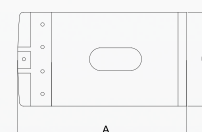

43500 Grampos T/50
* T/50 Staple Pins
Grapas T/50

REF.	Tamanho Size <i>Tamaño</i>	EAN 789.1114	Embalagem Package <i>Embalaje</i>			Dimensões Dimensions (mm)		
			Un.	KG	Comp x larg x alt Length x width x height <i>Largo x ancho x altura</i>	A	B	C
43500/506	6mm	05629 7	12	1,40	215 x 135 x 105mm	1,2	10,6	6
43500/508	8mm	05630 3	12	1,70	215 x 135 x 105mm	1,2	10,6	8
43500/510	10mm	05631 0	12	1,83	215 x 135 x 105mm	1,2	10,6	10
43500/513	13mm	05632 7	12	2,18	215 x 135 x 105mm	1,2	10,6	13

Modelo HT50 – 8mm.
Caixa com 500 unidades.
Apropriado para grampeador Tramontina.

IPI 10% incluso - NCM: 8305.20.00

HT50 – 8mm model.
Box with 500 units.
Suitable for Tramontina stapler.

*Modelo HT50 – 8mm.
Caja con 500 unidades.
Apropiado para grapadoras Tramontina.*

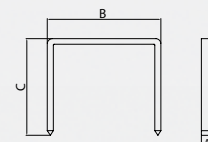

43756 Bastão de Silicone para Pistola de Cola
*** Glue Stick**
Bastón de Cola

REF.	Tamanho Size <i>Tamaño</i>	EAN 789.1114	Embalagem Package <i>Embalaje</i>			Dimensões Dimensions (mm)		
			Un.	KG	Comp x larg x alt Length x width x height <i>Largo x ancho x altura</i>	A	B	C
EMBALAGEM CLAM PACK 								
43756/310	7,5 cm	01539 3	12	0,41	195 x 85 x 85mm	7,5	75	25
			192	7,02	350 x 215 x 340mm			
43756/340	10 cm	01541 6	12	0,90	280 x 140 x 90mm	11	100	35
			144	11,25	570 x 300 x 290mm			

Cola a base de silicone com 6 unidades.
43756/310 para pistola 43755/510.
43756/340 para pistolas 43755/530 e 43755/560.

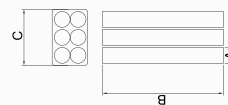

IPI 0% incluso - NCM: 3506.10.90

Silicone material.
43756/310 to electric glue gun 43755/510.
43756/340 to electric glue gun 43755/530 and 43755/560.

Pegamento a base de silicona.
43756/310 para pistola eléctrica 43755/510.
43756/340 para pistola eléctrica 43755/530 y 43755/560.

43302 Jogo de Lâminas para Arco de Serra
Hacksaw Blades Set
Juego de Seguetas para Arco de Sierra

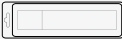
REF.	Peças Pieces <i>Piezas</i>	EAN 789.1114	Embalagem Package <i>Embalaje</i>			Dimensões Dimensions (mm)		
			Un.	KG	Comp x larg x alt Length x width x height <i>Largo x ancho x altura</i>	A	B	C
BLISTER 								
43302/902	2 und	09375 9	1		400 x 65 x 20mm	12,7	0,6	315

Aço ferramenta bi-metal.
Dentes reforçados.
Lâmina flexível.
Têmpera especial nos dentes de corte.
24 dentes por polegada.
Tamanho: 12"

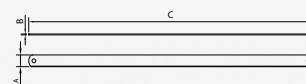

IPI 10% incluso - NCM: 4202.29.00



Special bi-metal tool steel.
Reinforced teeth.
Flexible blade.
Special heat treatment on the cutting teeth.
24 teeth per inch.
Size: 12"

Acero rápido bi-metal.
Dientes reforzados.
Lámina flexible.
Temple especial en los dientes de corte.
24 dientes por pulgada.
Tamaño: 12"





43185 Escova de Aço Base em Madeira
Steel Brush Wood Base
Cepillo de Acero Base en Madera

REF.	Tamanho Size <i>Tamaño</i>	EAN 789.1114	Embalagem Package <i>Embalaje</i>			Dimensões Dimensions (mm)		
			Un.	KG	Comp x larg x alt Length x width x height <i>Largo x ancho x altura</i>	A	B	C
43185/001		09429 9	1	0,15	275 x 40 x 55mm	35	270	48
			6	0,90	275 x 115 x 95mm			

Base em madeira especial.
Cerdas produzidas em aço carbono temperado.
4 fileiras de arame.

IPI 0% incluso - NCM: 9603.40.90

Special wood base.
Hardened steel bristles.
4 wire rows.

Base em madeira especial.
Cerdas de acero carbono templado.
4 hileras de alambre.

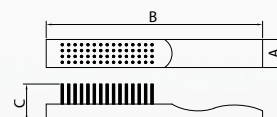

43185 Escova de Aço Base Plástica
Steel Brush Plastic Base
Cepillo de Acero Base en Plástico

REF.	Tamanho Size <i>Tamaño</i>	EAN 789.1114	Embalagem Package <i>Embalaje</i>			Dimensões Dimensions (mm)			
			Un.	KG	Comp x larg x alt Length x width x height <i>Largo x ancho x altura</i>	A	B	C	D
43186/001		09430 5	1	0,15	270 x 35 x 55mm	21	270	34	47
			6	0,90	275 x 115 x 95mm				

Base injetada.
Cerdas produzidas em aço carbono temperado.
4 fileiras de arame.

IPI 0% incluso - NCM: 9603.40.90

Injected base.
Hardened steel bristles.
4 wire rows.

Base inyectada.
Cerdas de acero carbono templado.
4 hileras de alambre.

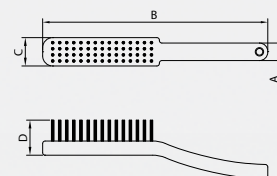

43188 Broxa Retangular Rectangular Brush Cepillo Rectangular

REF.	Tamanho Size <i>Tamaño</i>	EAN 789.1114	Embalagem Package <i>Embalaje</i>		Dimensões Dimensions (mm)				
			Un.	KG	Comp x larg x alt Length x width x height <i>Largo x ancho x altura</i>	A	B	C	D
43188/001		09428 2	1	0,2	220 x 180 x 90mm	215	75	180	76
			6	1,16	230 x 170 x 295mm				

Corpo produzido em PP injetado.
Cerdas produzidas em monofilamento bicolor.

IPI 0% incluso - NCM: 9603.40.90

Injected body.
Bicolor monofilament.

Cuerpo inyectado.
Cerdas en monofilamento bicolor.

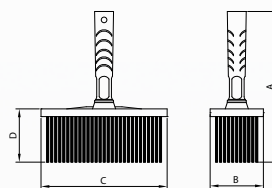

43408 Jogo de Brocas para Madeira Wood Drill Bit Set Juego de Brocas para Madera

REF.	Peças Pieces Piezas	EAN 789.1114	Embalagem Package <i>Embalaje</i>		Dimensões Dimensions (mm)		
			Un.	KG	Comp x larg x alt Length x width x height <i>Largo x ancho x altura</i>	A	B
43408/509	4 pcs pcs	09408 4	1			170	78
			12				

Corpo em aço carbono.
Têmpera total no corpo.
Acabamento fosfatizado.

Composição: brocas de 4, 5, 6 e 8mm

IPI 8% incluso - NCM: 8207.50.11

Carbon steel blade
Full hardening at the body
Phosphated finishing.

Set includes: 4, 5, 6 and 8mm drill sizes

Cuerpo en acero carbono.
Temple total en el cuerpo.
Acabado fosfatado.

Composición: brocas de 4, 5, 6 y 8mm

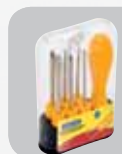
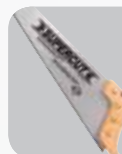
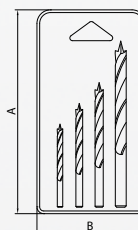



43408 Jogo de Brocas para Concreto Masonry Drill Bit Set Juego de Brocas para Cemento

REF.	Peças Pieces Piezas	EAN 789.1114	Embalagem Package Embalaje		Dimensões Dimensions (mm)	
			Un.	KG	Comp x larg x alt Length x width x height Largo x ancho x altura	A
43408/510	4 pcs pcs	09409 1	1			170 78
			12			

Corpo em aço carbono.
Ponta em carboneto de tungstênio (metal duro).
Têmpera total no corpo.
Acabamento cromado.
DIN 8039.

Composição: brocas de 4, 5, 6 e 8mm
IPI 8% incluso - NCM: 8207.19.00

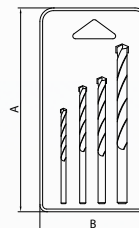

Carbon steel body.
Tungsten carbide tip.
Full hardening at the body.
Chrome plated finishing.
DIN 8039.

Set includes: 4, 5, 6 and 8mm drill sizes

Cuerpo en acero carbono.
Punta de carburo de tungsteno.
Temple total en el cuerpo.
Acabado cromado.
DIN 8039.

Composición: brocas de 4, 5, 6 y 8mm



43408 Jogo de Brocas Aço Rápido HSS Drill Bit Set Juego de Brocas de Acero Rápido

REF.	Peças Pieces Piezas	EAN 789.1114	Embalagem Package Embalaje		Dimensões Dimensions (mm)	
			Un.	KG	Comp x larg x alt Length x width x height Largo x ancho x altura	A
43408/511	5 pcs pcs	09410 7	1			170 78
			12			

Corpo em aço rápido (HSS).
Tempera total no corpo.
Corpo polido e envernizado.
Ângulo de afiação da ponta de 118°
DIN 338

Composição: brocas de 3, 4, 5, 6 e 8mm.
IPI 8% incluso - NCM: 8207.50.11

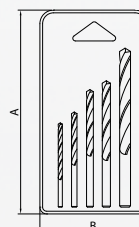

High speed steel blade (HSS).
Full hardening at the body.
Polished and fully varnished.
Point angle sharpened with 118°
DIN 338

Set includes: 3, 4, 5, 6 and 8mm drill bit sizes.

Cuerpo en acero rápido (HSS).
Temple total en el cuerpo.
Acabado pulido y barnizado.
Ângulo del afilado de la punta con 118°
DIN 338

Composición: brocas de 3, 4, 5, 6 y 8mm.

43408 Jogo de Brocas Mix Mix Drill Bit Set *Juego de Brocas Mix*

REF.	Peças Pieces Piezas	EAN 789.1114	Embalagem Package Embalaje		Dimensões Dimensions (mm)	
			Un.	KG	Comp x larg x alt Length x width x height Largo x ancho x altura	A
43408/512	9 pcs pcs	09411 4	1		210	190
			12			

Composição:

- 3 brocas para madeira, tamanhos 5, 6 e 8mm.
- 3 brocas para concreto, tamanhos 5, 6 e 8mm.
- 3 brocas para aço, tamanhos 5, 6 e 8mm

IPI 8% incluso - NCM: 8207.50.11

Set includes:

- 3 wood drill bits, sizes 5, 6 and 8mm.
- 3 masonry drill bits, sizes 5, 6 and 8mm.
- 3 HSS drill bits, sizes 5, 6 and 8mm.

Composición:

- 3 brocas para madera, tamaños 5, 6 y 8mm.
- 3 brocas para cemento, tamaños 5,6 y 8mm.
- 3 brocas para acero, tamaños 5, 6 y 8mm.

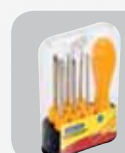
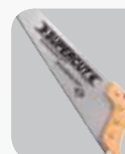
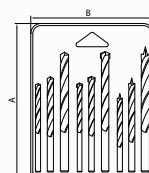



43980 Expositor para Martelos
Hammers Display
Exhibidor para Martillos

REF.	EAN 789.1114	Embalagem Package Embalaje		
		Un.	KG	Comp x larg x alt Length x width x height Largo x ancho x altura
43980/022	04251 1	1	5,30	560 x 210 x 660mm

Estrutura em aço carbono.
Pintura eletrostática.

IPI 10% incluso - NCM: 9403.20.00

Carbon steel structure.
Electrostatic painting.

*Estructura en acero carbono.
Pintura electrostática.*

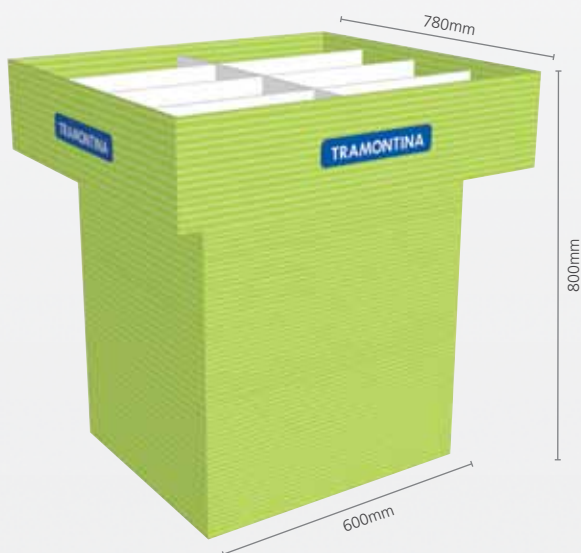

43980 Expositor de Papelão
Carton Display
Exhibidor de Cartón

REF.	EAN 789.1114	Embalagem Package Embalaje		
		Un.	KG	Comp x larg x alt Length x width x height Largo x ancho x altura
43980/032	05598 6	1	0,88	1.170 x 720 x 50mm

Corpo em papelão resistente.

IPI 15% incluso - NCM: 4819.10.00

Resistant carton structure.

Estructura resistente de cartón.

43980 Expositor Metálico Metallic Display Exhibidor Metálico

REF.	EAN 789.1114	Embalagem Package Embalaje		
		Un.	KG	Comp x larg x alt Length x width x height Largo x ancho x altura
43980/054	07200 6	1	57,00	900 x 900 x 2.190mm

Estrutura em aço carbono.
Pintura eletrostática.
Pés com regulagem de altura.
Acompanha ganchos.

Este expositor pode ser usado dos dois lados.

IPI 10% incluso - NCM: 9403.20.00

Carbon steel structure.
Electrostatic painting.
Feet with height adjustment.
With hooks.
This display can be used both sides.

*Estructura en acero carbono.
Pintura electrostática.
Pies con reglaje de altura.
Acompaña ganchos.
Este exhibidor puede ser utilizado por los dos lados.*



43980 Expositor Metálico Metallic Display Exhibidor Metálico

REF.	EAN 789.1114	Embalagem Package Embalaje		
		Un.	KG	Comp x larg x alt Length x width x height Largo x ancho x altura
43980/062	07587 8	1	45,00	450 x 900 x 2.190mm

Estrutura em aço carbono.
Pintura eletrostática.
Pés com regulagem de altura.
Acompanha ganchos.

IPI 10% incluso - NCM: 9403.20.00

Carbon steel structure.
Electrostatic painting.
Feet with height adjustment.
With hooks.
Tools are not included.

*Estructura en acero carbono.
Pintura electrostática.
Pies con reglaje de altura.
Acompaña ganchos.
No incluye las herramientas.*

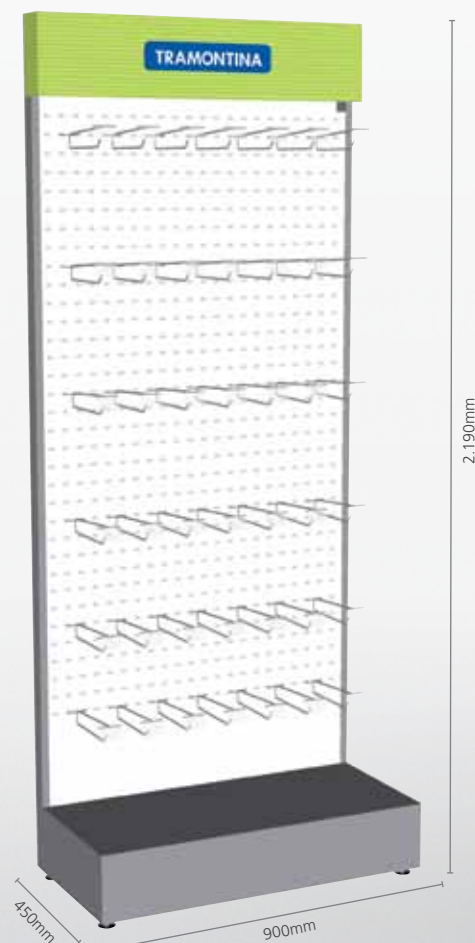

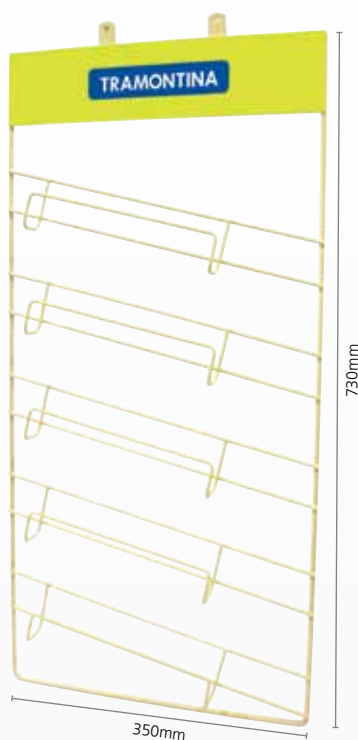

43980 Expositor para Martelos
Hammers Display
Exhibidor para Martillos

REF.	EAN 789.1114	Embalagem Package Embalaje		
		Un.	KG	Comp x larg x alt Length x width x height Largo x ancho x altura
43980/013	02717 4	1	1,41	730 x 350 x 60mm

Estrutura em aço carbono.
Pintura eletrostática.

IPI 10% incluso - NCM: 9403.20.00

Carbon steel structure.
Electrostatic painting.

*Estructura en acero carbono.
Pintura electrostática.*

**Produto para
exportação**

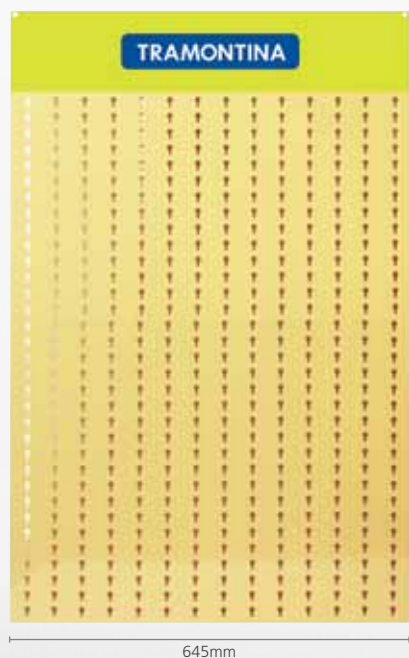

43980 Expositor para Ferramentas
Tools Display
Exhibidor para Herramientas

REF.	EAN 789.1114	Embalagem Package Embalaje		
		Un.	KG	Comp x larg x alt Length x width x height Largo x ancho x altura
43980/036	06943 3	1	8,7	15 x 645 x 975mm

Estrutura em aço carbono.
Pintura eletrostática.

IPI 10% incluso - NCM: 9403.20.00

Carbon steel structure.
Electrostatic painting.

*Estructura en acero carbono.
Pintura electrostática.*

**Produto para
exportação**

43980 Folhetos
Leaflets
Folletos

REF.	EAN 789.1114	Embalagem Package Embalaje		
		Un.	KG	Comp x larg x alt Length x width x height Largo x ancho x altura
43980/015	032093	100	2,63	250 x 180 x 80mm

Produto para
exportação

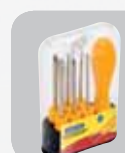
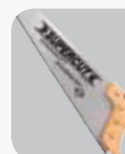

43980 Catálogo Linha Master
Master Line Catalogue
Catálogo Línea Master

REF.	EAN 789.1114	Embalagem Package Embalaje		
		Un.	KG	Comp x larg x alt Length x width x height Largo x ancho x altura
43980/020	040937	20	5,00	320 x 235 x 10mm
		50	13,90	320 x 235 x 245mm

Produto para
exportação



Estrutura Comercial | Business Structure | *Estructura Comercial*

Brasil



Escritórios Regionais de Vendas

- 1 - Tramontina Sul S.A. - Filial Porto Alegre**
Rua General Neto, 594 - Bairro Floresta
Porto Alegre - RS - 90560-020
Tel.: 51 2101-5000
Fax: 51 3222-4184
- 2 - Tramontina Sul S.A. - Filial Curitiba**
Rua Padre Anchieta, 1923 - 16º andar
Curitiba - PR - 80730-000
Tel.: 41 2111-9110
Fax: 41 2111-9100
- 3 - Tramontina Sudeste S.A. - Filial Rio de Janeiro**
Av. Henrique Valadares, 23 - Salas 801/802 - Centro
Rio de Janeiro - RJ - 20231-030
Tel.: 21 2224-5004
Fax: 21 2224-5248
- 4 - Tramontina Sudeste S.A - Filial Belo Horizonte**
Av. Uruguai, 21 - 13º andar - Bairro Sion
Belo Horizonte - MG - 30310-300
Tel.: 31 3223-4026
Fax: 31 3223-4524
- 5 - Tramontina Nordeste S.A - Filial Recife**
Av. Barão do Bonito, 1110
Bloco A - Bairro da Várzea
Recife - PE - 50740-080
Tel.: 81 3454-8800
Fax: 81 3454-8801

Centros de Distribuição

Tramontina Sul S.A.

Rua Garibaldi, 308
Centro
Carlos Barbosa - RS - 95185-000
Tel.: 54 3461-7700
Fax: 54 3461-1607

Tramontina Nordeste S.A.

Rodovia BR 324, KM 17 s/nº
CIA
Simões Filho - BA - 43700-000
Tel.: 71 3215-8266
Fax: 71 3215-8299

Tramontina Sudeste S.A.

Av. Aruanã, 684
Bairro Tamboré
Barueri - SP - 06460-010
Tel.: 11 4197-1266
Fax: 11 4195-1485

Tramontina Norte S.A.

Distrito Industrial de Icoaraci
Av. Principal, 700 Setor C, Quadra 2
Belém - PA - 66815-590
Tel.: 91 3211-7700
Fax: 91 3211-7701

Tramontina Planalto S.A.

Rua Bom Sucesso, 51
Bairro Ipiranga
Goiânia - GO - 74453-050
Tel.: 62 3272-2100
Fax: 62 3272-2122

Estrutura Comercial | Business Structure | *Estructura Comercial*

Tramontina International | *Tramontina Internacional*

TRAMONTINA USA, INC. (TUSA)

Sugar Land, Texas - U.S.A.
Tel.: (1) 281 340.8400

TRAMONTINA HAUSHALTSWAREN GmbH (THAUS)

Köln (Porz) - Germany
Tel.: (49) 2203 69.992-0

TRAMONTINA DE MÉXICO S.A. de C.V. (TEMEX)

Huixquilucan - Estado de México - México
Tel.: (52) 55 5950.0470

TRAMONTINA DE COLÔMBIA E.U. (TECOL)

Bogotá - Colômbia
Tel.: (57) 1 623.4500

TRAMONTINA DE CHILE LTDA (TCHILE)

Comuna de Providencia - Santiago - Chile
Tel.: (56) 2 264.0500

TRAMONTINA DEL PERU S.A.C. (TPERU)

Miraflores, 18 - Lima - Peru
Tel.: (51) 1 241.9671

TRAMONTINA FRANCE S.A.R.L. (TFRANCE)

Paris - Cedex 11 - France
Tel.: (33) 1 4021.4222

TRAMONTINA UAE L.L.C. (TDUBAI)

Dubai - U.A.E.
Tel.: (971) 50 873.3717
(971) 50 453.7257

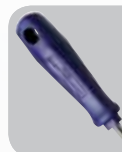

Sales Conditions / Condiciones de Ventas

GENERAL GUIDE LINES

- 1) Prices stated on our price lists are gross, per unit and at an FOB South Brazilian ports basis. Get in touch with **export@tramontina.net** to verify their validity.
- 2) Ask for our special freight rates for CFR shipments.
- 3) Ordered quantities will be adjusted to the factory's packaging.
- 4) Brazilian Origin Certificate is not available for products marked with *.
- 5) Ask for the minimum quantity for products marked with •.
- 6) Payment conditions: Anticipated to the shipment or by L/C at sight.

Payment details and bank information for T/T:

- 1) When effecting payments by T/T always indicate Tramontina Garibaldi as the beneficiary and the proforma invoice or commercial invoice as reference.
- 2) Consider Banco do Brasil or Banco Itaú as follows:

DIRECTRICES GENERALES

- 1) Los precios de nuestras listas de precios son brutos, unitarios y FOB puertos Sud-Brasileños. Contacte a **export@tramontina.net** para corroborar su validez.
- 2) Consulte nuestras tarifas especiales de flete para embarques CFR.
- 3) Las cantidades solicitadas serán ajustadas al embalaje de fábrica.
- 4) El Certificado de Origen no está disponible para productos señalizados con *.
- 5) Consulte la cantidad mínima de productos señalizados con •.
- 6) Condiciones de pago: Anticipado al embarque o a través de Carta de Crédito a la vista.

Datos de pago y de bancos para transferencia bancaria:

- 1) Al efectuar pagos por transferencia bancaria siempre indicar Tramontina Garibaldi como beneficiario y la factura proforma o factura comercial como referencia.
- 2) Considerar Banco do Brasil o Banco Itaú conforme se expresa en el cuadro de abajo:

BANCO DO BRASIL - TELEGRAPHIC TRANSFERS / TRANSFERENCIA BANCARIA	
USD	EUR
Banco do Brasil New York Branch Swift: BRASUS33 FedWire ABA Number//FW026003557 or CHIPS UID //CH023960	Banco do Brasil Frankfurt Branch Swift: BRASDEFF BLZ system // BL 51220800
Beneficiary Bank Banco do Brasil S.A. Porto Alegre Branch SWIFT : BRASBRJPAAE	
Reference: Proforma / Commercial Invoice / Factura Comercial Beneficiary: Tramontina Garibaldi S.A. Ind. Met. Rua Tramontina, 600 – CEP 95720-000 – Garibaldi – RS – Brasil Tel. +55 54 3462 8000 / Fax +55 54 3462 1577 / www.tramontina.com/pro	

BANCO ITAÚ - TELEGRAPHIC TRANSFERS / TRANSFERENCIA BANCARIA	
USD	EUR
Standard Chartered Bank New York – USA Swift: SCBLUS33 Account / Cuenta: 3544-030205-001	Dresdner Bank Ag Frankfurt – Germany Swift: DRESDEFF Account / Cuenta: 499/08002708/00/888 IBAN: DE75500800000800270800
Beneficiary Bank Beneficiary Bank Banco Itaú BBA S/A – São Paulo head-office Codigo Swift: CBBABRSP	
Reference: Proforma / Commercial Invoice / Factura Comercial Beneficiary: Tramontina Garibaldi S.A. Ind. Met. Rua Tramontina, 600 – CEP 95720-000 – Garibaldi – RS – Brasil Tel. +55 54 3462 8000 / Fax +55 54 3462 1577 / www.tramontina.com	

Bank details and the indicated steps must be followed when opening L/C:

- a) Credits must be irrevocable and at sight.
- b) Transshipment and partial shipments allowed.
- c) L/C must bear a 5% variation on its quantity and amount.
- d) For consolidated shipments along with other Tramontina Units, one single L/C is acceptable once its credit is transferrable and the description of the goods states the Proforma Invoice number and products of all Tramontina factories involved.
- e) Latest date of shipment shall be 90 days after the proforma invoice's final confirmation date.
- f) The limit for presenting documents to the Brazilian bank has to be 21 days after shipment.
- g) L/C opening charges and all other banking charges outside Brazil are on applicant's account.
- h) L/C application form must be sent in advance of the L/C opening for an evaluation and approval to the fax number +55 54 3462 1577 or by e-mail export@tramontina.net. Otherwise, if L/C amendments are needed, the cost will be on applicant's account.
- i) Indicate Banco do Brasil or Banco Itaú as L/C advising bank as follows:

Los datos bancarios e instrucciones que deben ser seguidas para la apertura de Carta de Crédito son las siguientes:

- a) El crédito debe ser irrevocable y a la vista.
- b) Trasbordos y embarques parciales deben ser permitidos.
- c) La Carta de Crédito deberá soportar una variación del 5% en las cantidades y valores.
- d) Para embarques consolidados con otras unidades de Tramontina, una única Carta de Crédito es aceptable siempre y cuando su crédito sea transferible y la descripción de las mercaderías indique el número de las facturas proforma y productos de todas las fábricas de Tramontina involucradas.
- e) La última fecha de embarque deberá ser de 90 días después de la fecha de confirmación final de la factura proforma.
- f) El límite para presentación de documentos al banco brasileño deberá ser 21 días después de la fecha de embarque.
- g) Las tasas de apertura y otros costos bancarios fuera de Brasil son por cuenta del cliente.
- h) El formulario de apertura de la Carta de Crédito debe ser enviado con antelación a la apertura de la Carta de Crédito al fax número +55 54 3462 1577 o por correo electrónico al export@tramontina.net. De lo contrario, los costos de enmiendas, si son necesarias, serán por cuenta del cliente.
- i) Indicar al Banco do Brasil o al Banco Itaú como avisador conforme el siguiente cuadro:

ADVISING BANKS FOR L/C / BANCO AVISADOR PARA CARTA DE CRÉDITO

Banco Itaú S.A.

Rua Siqueira Campos, 833 – Sobrelaja
90010-902 - Porto Alegre - RS - Brasil
TEL.: +55 51 3210-9131
Swift: ITAUBRSP
Agency: 0280
Account: 09492-1
E-mail: usc.portolagre@itau.com.br

Banco do Brasil S.A.

Rua Uruguai, 185.
90010-140 - Porto Alegre - RS - Brasil
TEL.: +55 51 3214-7768
Swift : BRASBRJP
Agency: 3305-7
Account: 3187-9
E-mail : age1690@bb.com.br

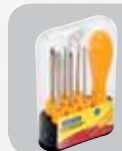

Informações Gerais | General Information | *Informaciones Generales*

Fotos dos produtos | Products images | *Imagen de los productos:*

- Algumas fotos ou imagens contidas neste catálogo são meramente ilustrativas.
- Some pictures presented in this catalogue are merely illustrative.
- *Algunas imágenes presentadas en este catálogo son meramente ilustrativas.*

Alterações/modificações de produto | Changes to products | *Modificaciones en los productos:*

- A Tramontina reserva-se no direito de alterar qualquer um dos itens contidos neste catálogo, com o objetivo de melhorá-los ou sempre que existam razões técnicas ou comerciais para isto. Qualquer alteração que vier a ser efetivada está isenta de aviso prévio e não obriga à modificação das unidades já vendidas.
- Tramontina reserves the right to change items presented in this catalogue, with the purpose of improvement based on technical or commercial feedback. These change are exempt of advance notice and do necessitate the replacement of the units already sold.
- *Tramontina reserva el derecho de modificar cualquier producto presente en este catálogo, con el objetivo de mejorarlo o siempre que existan razones técnicas o comerciales para eso. Cualquier alteración que sea efectuada está exenta de aviso previo y no obliga la reposición de las unidades ya vendidas.*

Cancelamento ou retirada de produção | Cancellation or discontinued items | *Retiro o discontinuación de productos:*

- A Tramontina reserva-se no direito de retirar de produção ou anular a comercialização de qualquer item presente neste catálogo.
- Tramontina reserves the right to take out of production or cancel the commercialization of any items presented in this catalogue.
- *Tramontina reserva el derecho de retirar de producción o anular la comercialización de cualquier producto presente en este catálogo.*

Medidas e pesos | Measurements and weights | *Medidas y pesos:*

- Os valores relativos a pesos e medidas contidos neste catálogo são sujeitos a alterações.
- The values related to weight and measurements presented in this catalogue are subject to change.
- *Los valores relativos a pesos y medidas contenidos en este catálogo están sujetos a modificaciones.*

Índice numérico | Numeric index | Índice numérico

REF.	PAG.	REF.	PAG.	REF.	PAG.	REF.	PAG.	REF.	PAG.	REF.	PAG.
40200/018	12	40401/000	26	40457/020	32	40710/016	21	41013/110	53	41120/113	84
40200/020	12	40402/006	27	40458/000	31	40710/020	21	41014/109	49	41120/205	84
40200/023	12	40402/008	27	40460/000	32	40710/022	21	41016/506	93	41120/208	84
40200/025	12	40402/012	27	40501/002	35	40711/000	24	41016/508	93	41120/212	84
40200/027	12	40410/004	25	40501/003	35	40722/000	38	41016/510	93	41128/110	92
40200/029	12	40410/008	25	40501/004	35	40722/001	38	41016/512	93	41128/111	92
40201/025	15	40410/012	25	40502/002	35	40722/002	38	41017/116	53	41128/112	92
40201/027	15	40410/016	25	40502/003	35	40723/001	37	41017/118	53	41128/113	92
40203/008	17	40410/020	25	40502/004	35	40723/002	37	41018/108	57	41128/114	92
40203/013	17	40410/024	25	40503/002	36	40723/003	37	41050/106	58	41128/115	92
40203/016	17	40410/032	25	40503/003	36	40731/025	28	41050/108	58	41128/116	92
40203/020	17	40410/040	25	40503/004	36	40731/030	28	41050/110	58	41128/117	92
40205/016	19	40430/000	25	40504/000	36	40731/035	28	41051/120	58	41128/118	92
40205/020	19	40441/025	27	40504/001	36	40731/040	28	41051/122	58	41128/119	92
40206/016	20	40441/028	27	40504/002	36	40731/045	28	41051/125	58	41128/120	92
40206/020	20	40441/030	27	40504/003	36	40732/016	29	41051/128	58	41128/121	92
40206/022	20	40441/032	27	40504/004	36	40732/018	29	41051/130	58	41128/122	92
40207/016	21	40441/035	27	40505/001	37	40732/020	29	41053/110	59	41128/123	92
40207/020	21	40441/040	27	40505/002	37	40732/022	29	41053/112	59	41128/124	92
40207/022	21	40441/045	27	40505/003	37	40732/025	29	41053/113	59	41128/125	92
40300/027	12	40441/050	27	40508/001	34	40732/030	29	41054/110	59	41128/126	92
40300/029	12	40442/016	28	40508/002	34	40733/016	30	41054/112	59	41128/127	92
40301/025	16	40442/018	28	40508/003	34	40733/018	30	41055/106	61	41128/128	92
40301/027	16	40442/020	28	40508/004	34	40740/001	33	41057/116	61	41128/130	92
40303/008	16	40442/022	28	40510/000	38	40800/027	14	41057/118	61	41128/132	92
40303/013	16	40442/025	28	40510/001	38	40804/016	18	41057/120	61	41128/205	93
40303/016	16	40442/030	28	40510/002	38	40890/027	14	41065/109	54	41128/208	93
40303/020	16	40443/001	26	40510/003	38	40891/016	18	41066/110	54	41128/212	93
40304/016	19	40443/002	26	40510/004	38	40891/020	18	41070/110	55	41128/215	93
40304/020	19	40443/003	26	40550/001	40	40892/016	22	41071/110	55	41128/217	93
40351/000	15	40443/004	26	40550/002	40	40892/020	22	41105/301	56	41135/110	42
40355/000	23	40443/005	26	40550/003	40	40893/020	22	41105/302	56	41135/112	42
40355/001	23	40443/006	26	40560/001	41	41001/107	48	41105/303	57	41135/114	42
40360/001	24	40443/007	26	40561/000	39	41001/108	48	41110/506	134	41136/110	43
40360/002	24	40443/008	26	40562/001	40	41001/118	48	41120/101	84	41136/112	43
40360/003	24	40443/009	26	40562/002	40	41002/106	49	41120/102	84	41136/114	43
40365/001	23	40443/010	26	40562/003	40	41002/107	49	41120/103	84	41170/300	120
40365/002	23	40443/011	26	40563/001	41	41006/106	50	41120/104	84	41175/508	134
40365/003	23	40443/012	26	40564/000	39	41006/116	50	41120/105	84	41175/509	135
40365/004	23	40445/016	29	40682/008	34	41008/106	51	41120/106	84	41180/001	135
40370/018	13	40445/018	29	40682/016	34	41008/116	51	41120/107	84	41180/019	142
40370/020	13	40450/000	33	40700/027	13	41010/106	52	41120/108	84	41180/020	143
40370/023	13	40455/000	30	40703/016	20	41012/114	52	41120/109	84	41180/101	143
40370/025	13	40456/018	31	40703/020	20	41012/116	52	41120/110	84	41180/102	144
40370/027	13	40456/024	31	40705/016	17	41012/119	52	41120/111	84	41180/103	144
40370/029	13	40457/016	32	40705/020	17	41012/122	52	41120/112	84	41181/007	154

Índice numérico | Numeric index | Índice numérico

REF.	PAG.	REF.	PAG.	REF.	PAG.	REF.	PAG.	REF.	PAG.	REF.	PAG.
41191/040	153	41450/011	67	41516/504	72	42006/101	81	42245/103	87	42700/112	42
41192/024	142	41450/012	67	41516/506	72	42006/102	81	42245/104	87	42700/114	42
41400/010	64	41500/010	68	41516/507	73	42006/103	81	42245/105	87	42700/116	42
41400/011	64	41500/011	68	41520/110	74	42006/104	81	42245/106	87	42700/910	42
41400/012	64	41500/012	68	41520/111	74	42006/105	81	42245/107	87	42700/912	42
41400/013	64	41500/013	68	41520/120	74	42006/106	81	42245/108	87	42701/108	43
41400/020	64	41500/020	68	41520/121	74	42006/107	81	42245/109	87	42701/110	43
41400/021	64	41500/021	68	41520/122	74	42006/108	81	42245/110	87	42701/112	43
41400/022	64	41500/022	68	41520/123	74	42006/109	81	42245/111	87	42701/114	43
41400/023	64	41500/023	68	41520/130	74	42006/110	81	42245/112	87	42701/116	43
41400/030	64	41500/030	68	41520/132	74	42006/111	81	42245/113	87	42705/108	43
41400/031	64	41500/031	68	41520/133	74	42006/112	81	42245/114	87	42705/110	43
41400/032	64	41500/032	68	41520/142	74	42006/113	81	42245/115	87	42705/112	43
41400/033	64	41500/033	68	41520/143	74	42021/208	86	42245/116	87	42705/114	43
41400/034	64	41500/034	68	41525/110	75	42021/212	86	42245/117	87	42705/116	43
41400/040	64	41500/040	68	41525/111	75	42021/514	86	42246/106	88	42705/910	44
41400/041	64	41500/041	68	41525/120	75	42025/101	85	42246/107	88	42705/912	44
41400/042	64	41500/042	68	41525/121	75	42025/102	85	42246/108	88	42709/101	44
41400/043	64	41500/043	68	41525/130	75	42026/101	85	42246/109	88	42709/102	44
41400/044	64	41500/044	68	41525/131	75	42026/102	85	42246/110	88	42805/108	94
41400/045	64	41500/045	68	41525/140	75	42026/103	85	42246/111	88	42805/109	94
41400/050	64	41500/050	68	41526/506	76	42026/104	85	42246/112	88	42805/110	94
41400/051	64	41500/051	68	41700/306	166	42026/105	85	42246/113	88	42805/111	94
41400/052	64	41500/052	68	41701/308	167	42026/106	85	42246/114	88	42805/112	94
41400/053	64	41500/053	68	41702/308	167	42026/107	85	42246/115	88	42805/113	94
41402/001	65	41501/100	69	41710/310	168	42026/108	85	42246/116	88	42805/114	94
41402/002	65	41502/001	69	41711/310	168	42026/109	85	42246/117	88	42805/115	94
41405/010	65	41502/002	69	41900/110	77	42026/110	85	42246/118	88	42805/116	94
41405/011	65	41505/010	70	41905/306	136	42026/111	85	42246/119	88	42805/117	94
41405/020	65	41505/011	70	41990/000	77	42026/112	85	42246/120	88	42805/118	94
41405/021	65	41505/020	70	42000/208	82	42240/108	89	42246/121	88	42805/119	94
41405/022	65	41505/021	70	42001/108	82	42240/216	89	42246/122	88	42806/100	94
41405/030	65	41505/022	70	42001/118	82	42241/108	89	42246/123	88	42806/101	94
41405/031	65	41505/030	70	42001/206	83	42241/110	89	42246/124	88	42806/102	94
41405/032	65	41505/031	70	42001/208	83	42241/118	90	42246/125	88	42806/103	94
41405/040	65	41505/032	70	42001/212	83	42241/206	90	42246/126	88	42806/104	94
41405/050	65	41505/040	70	42001/506	83	42241/208	90	42246/127	88	42806/105	94
41407/001	66	41505/050	70	42001/514	83	42241/210	90	42246/128	88	42806/106	94
41407/002	66	41507/001	70	42005/100	80	42241/212	90	42246/130	88	42810/001	95
41415/006	66	41507/002	70	42005/101	80	42241/215	90	42246/132	88	42810/002	95
41415/505	66	41508/013	71	42005/102	80	42241/217	90	42600/050	45	42810/003	95
41450/006	67	41508/014	71	42005/103	80	42241/506	91	42600/060	45	42810/004	95
41450/007	67	41508/015	71	42005/104	80	42241/514	91	42601/060	45	42810/005	95
41450/008	67	41509/013	71	42005/105	80	42245/100	87	42601/090	45	42810/006	95
41450/009	67	41509/014	71	42005/106	80	42245/101	87	42700/108	42	42810/007	95
41450/010	67	41516/425	73	42005/107	80	42245/102	87	42700/110	42	42810/008	95

Índice numérico | Numeric index | Índice numérico

REF.	PAG.	REF.	PAG.	REF.	PAG.	REF.	PAG.	REF.	PAG.	REF.	PAG.
42811/001	95	43194/006	125	43330/102	115	43408/142	149	43757/301	130		
42830/117	96	43194/012	125	43330/103	115	43408/143	150	43760/300	129		
42830/119	96	43199/002	124	43330/104	115	43408/304	150	43761/300	131		
42830/121	96	43200/016	110	43330/105	115	43408/306	151	43761/301	131		
42830/124	96	43200/018	110	43330/106	115	43408/308	151	43761/302	131		
42860/001	96	43200/020	110	43330/107	115	43408/323	146	43800/001	160		
42860/002	97	43200/022	110	43330/108	115	43408/334	76	43800/002	160		
43100/012	100	43204/016	110	43330/109	115	43408/500	140	43800/003	161		
43100/014	100	43204/018	110	43331/502	116	43408/502	140	43801/022	163		
43100/018	100	43204/020	110	43331/504	116	43408/503	141	43801/040	163		
43100/024	100	43204/022	110	43333/103	117	43408/505	141	43900/586	155		
43110/012	100	43240/016	108	43333/105	117	43408/509	173	43980/013	178		
43110/018	100	43240/018	108	43333/107	117	43408/511	174	43980/015	179		
43120/012	101	43240/020	108	43333/109	117	43408/900	156	43980/020	179		
43120/014	101	43240/022	108	43335/001	117	43408/901	156	43980/022	176		
43120/018	101	43240/024	108	43335/002	117	43408/902	157	43980/032	176		
43120/024	101	43240/026	108	43335/003	117	43408/904	157	43980/036	178		
43121/000	166	43242/016	108	43335/004	117	43408/906	158	43980/054	177		
43140/000	101	43242/018	108	43335/005	117	43408/907	158	43980/062	177		
43155/310	102	43242/020	108	43335/006	117	43408/908	159				
43155/320	102	43242/022	108	43335/007	117	43408/910	159				
43155/330	102	43242/024	108	43335/008	117	43409/001	161				
43156/303	102	43242/026	108	43335/009	117	43409/012	162				
43156/305	102	43244/015	109	43336/502	118	43409/014	162				
43156/310	102	43244/018	109	43336/504	118	43410/030	152				
43156/375	102	43244/020	109	43350/002	119	43411/001	136				
43170/010	103	43244/022	109	43352/003	119	43411/007	155				
43170/012	103	43245/018	109	43370/302	169	43412/910	146				
43171/010	103	43245/020	109	43370/303	170	43500/500	125				
43171/012	103	43245/022	109	43390/300	120	43500/506	170				
43180/001	105	43245/024	109	43390/301	121	43500/508	170				
43180/501	105	43245/026	109	43390/302	121	43500/510	170				
43181/501	105	43280/012	111	43390/500	169	43500/513	170				
43185/001	172	43285/010	111	43400/304	137	43600/022	154				
43186/001	172	43285/012	111	43404/503	147	43752/502	128				
43188/001	173	43285/014	111	43406/507	137	43752/503	128				
43190/002	124	43290/012	112	43408/009	145	43752/504	128				
43190/003	124	43290/014	112	43408/019	145	43752/505	128				
43190/004	124	43291/012	113	43408/115	138	43752/506	128				
43190/006	124	43293/014	112	43408/116	138	43752/507	128				
43190/008	124	43294/014	113	43408/117	147	43755/510	128				
43190/010	124	43301/012	114	43408/118	139	43755/530	128				
43190/012	124	43302/012	114	43408/120	148	43755/560	128				
43192/001	125	43302/902	171	43408/122	139	43756/310	171				
43192/002	125	43315/012	115	43408/123	148	43756/340	171				
43192/003	125	43330/101	115	43408/133	149	43757/300	130				

Índice alfabético | Alphabetical index | *Índice alfabético*

NOME NAME	PAG.	NOME NAME	PAG.
Alicate bico chato	52	Marretas	34 a 38
Alicate bomba d'água	54	Martelo carpinteiro	28 e 29
Alicate corta cabos	57	Martelo de borracha	34
Alicate corte frontal	52 e 53	Martelo de pena	26 a 28
Alicate de pressão	55	Martelo eletricista	29 e 30
Alicate fazendeiro	53	Martelo pedreiro	31
Alicate para canos	54	Martelo picador	32
Alicates bico meia cana	51	Martelo picador de solda	30
Alicates corte diagonal	50	Martelo ponta e pá	33
Alicates para bijuterias	56 e 57	Martelo sapateiro	32
Alicates universais	48 e 49	Martelo tapeceiro	26 e 33
Arcos de serra	114	Martelo vidraceiro	25
Bastão de silicone	171	Martelos de bola	25
Bolhas para níveis	166	Martelos de unha	12 a 24
Bolsas para ferramentas	163	Níveis	100 e 101
Broxas	173	Pés de cabra	45
Caixas para ferramentas	160 e 161	Pistola aplicadora de silicone	124
Chaves ajustáveis	93	Pistola elétrica aplicadora de cola	128
Chaves biela	94	Plainas	119
Chaves canhão tubular	67	Ponteiros	43 e 44
Chaves combinadas	87 a 93	Prumos	105
Chaves de fenda	64 a 66 68 a 77	Serrotos	108 a 113
Chaves de roda	95 a 97	Talhadeiras	42 e 43
Chaves estrela	85 e 86	Torqueses	58 a 61
Chaves fixas	80 a 84	Trenas	102
Cintos para ferramentas	161 e 162		
Empunhadura	44		
Escovas de aço	172		
Esquadros	103		
Estiletos	120 e 121		
Expositores	176 a 178		
Ferro de solda	128		
Formões	115 a 118		
Grampeador manual	125		
Grampos	124 e 125		
Grampos T/50	170		
Grosas	168		
Jogo de lâminas para arcos de serra	171		
Jogos de brocas	173 a 175		
Jogos de ferramentas	134 a 159		
Lâminas para estiletos	169		
Lâminas para plainas	169 e 170		
Lanternas	129 a 131		
Limas	166 e 167		
Machadinhas	39 a 41		
Manípulo	95		

Índice alfabético | Alphabetical index | Índice alfabético

NOME NAME	PAG.	NOME NAME	PAG.
Adjustable wrenches	93	Ring spanners	85 and 86
Axes	39 up to 41	Rubber mallet	34
Ball pein hammers	25	Saws	108 up to 113
Bar	95	Screwdrivers	64 up to 66 68 up to 77
Brick hammer	31	Shoemaker's hammer	32
Brush	173	Silicone caulking gun	124
Chipping hammer	32	Snipe nose pliers	51 and 56
Chisels	42 and 43	Square	103
Claw hammers	12 up to 24	Steel brush	172
Clip	124 and 125	Stone pointed chisels	43 and 44
Combination pliers	48 and 49	Stoning hammers	34 up to 38
Combination wrenches	87 up to 93	T/50 staples pins	170
Diagonal cutting pliers	50 and 56	Tool bags	163
Displays	176 up to 178	Tool belts	161 and 162
Drill bit set	173 up to 175	Tool boxes	160 and 161
Electric glue gun	128	Tool sets	134 up to 159
Electrician's hammer	29 and 30	Tubular nut drivers	67
End cutting nippers	52 and 53	Vial for level	166
Falt nose pliers	52	Water pump pliers	54
Fence pliers	53	Welder's hammer	30
File	166 and 167	Welding gun	128
Flashlight	129 up to 131	Wheel nut wrenches	95 up to 97
Flat and pointed hammer	33	Wood chisels	115 up to 118
Glazier's hammer	25	Wrecking bar	45
Glue stick	171		
Grip	44		
Hacksaw	114		
Hacksaw blade set	171		
Hollow offset pipe wrenches	94		
Joiner's hammer	28 and 29		
Knives	120 and 121		
Knives blades	169		
Levels	100 and 101		
Lock pliers	55		
Machinist's hammers	26 up to 28		
Magnetic tack hammer	33		
Manual stapler	125		
Measuring tape	102		
Mini bolt cutter	57		
Open end wrenches	80 up to 84		
Pincers	58 up to 61		
Pipe wrench	54		
Planes	119		
Plumb	105		
Rasp file	168		
Replacement blades	169 and 170		

Índice alfabético | Alphabetical index | *Índice alfabético*

NOME NAME	PAG.	NOME NAME	PAG.
Arcos de sierra	114	Martillo electricista	29 y 30
Barra	95	Martillo picador	32
Barreta sacaclavos	45	Martillo tapicero	26 y 33
Bastón de cola	171	Martillo vidriero	25
Bolsas para herramientas	163	Martillo zapatero	32
Burbujas para niveles	166	Martillos de bola	25
Cajas porta herramientas	160 y 161	Martillos de uña	12 hasta 24
Cepillo	173	Mazas	34 hasta 38
Cepillos	119	Niveles	100 y 101
Cepillos de acero	172	Pinza corta cables	57
Cíncel de punta	43 y 44	Pinza corte frontal	52 y 53
Cinceles	42 y 43	Pinza para alambre	53
Cinta métrica	102	Pinza para caños	54
Cinturones porta herramientas	161 y 162	Pinza pico loro	54
Clips	124 y 125	Pinza punta chata	52
Cortadoras	120 y 121	Pinzas corte diagonal	50 y 56
Destornilladores	64 hasta 66 68 hasta 77	Pinzas de presión	55
Destornilladores de tuerca tubular	67	Pinzas punta media caña	51 y 56
Empuñadura	44	Pinzas universales	48 y 49
Escofinas	168	Pistola eléctrica aplicadora de cola	128
Escuadra	103	Pistola para sílicona	124
Exhibidores	176 hasta 178	Plomada	105
Formones	115 hasta 118	Serruchos	108 hasta 113
Grapadora manual	125	Tenazas	58 hasta 61
Grapas T/50	170		
Hachitas	39 hasta 41		
Hierro de soldadura	128		
Juego de seguetas para arcos de sierra	171		
Juegos de brocas	173 hasta 175		
Juegos de herramientas	134 hasta 159		
Láminas para cepillos	169 y 170		
Láminas para cortadoras	169		
Limas	166 y 167		
Linternas	129 hasta 131		
Llaves ajustables	93		
Llaves combinadas	87 hasta 93		
Llaves de pipa abierta	94		
Llaves de rueda	95 hasta 97		
Llaves estriadas	85 y 86		
Llaves fijas	80 hasta 84		
Martillo albanil	31		
Martillo carpintero	28 y 29		
Martillo con cabeza chata y punta	33		
Martillo de goma	34		
Martillo de pena	26 hasta 28		
Martillo de pico para soldadura	30		



TRAMONTINA GARIBALDI S.A. IND. MET. Rua Tramontina, 600 - CEP 95720-000 - Garibaldi/RS - Brasil - Phone: +55 [54] 3462-8000

www.tramontina.com