

process AUTOMATION

SIEMENS

SIREC
Recorders and Accessories



Related Catalogs

Field Instruments for Process Automation Order No.: E86060-K6201-A101-A3-7600	FI 01		Liquid Analytics Order No.: E86060-K3520-A101-A1-7600	PA 20	
SIREC Process Recorders and Accessories Order No.: E86060-K6020-A101-A2-7600	MP 20		SIPOS Electric Actuators Electric Rotary, Linear and Part-turn Actuators Order No.: E20185-P920-A900-X-7600	MP 35	
SIWAREX Weighing Systems Order No.: E86060-K6401-A101-A1-7600	WT 01		SIMATIC NET Industrial Communication and Field Devices Order No.: E86060-K6710-A101-B3-7600	IK PI	
OXYMAT 6 Gas Analyzers for Determination of Oxygen Order No. (PDF): E86060-K3510-B101-A3-7600	Catalog Extract PA 10		SITRAIN™ Information and Training Automation and Drives Order No.: E86060-K6850-A101-B3 (German)	ITC	
ULTRAMAT 6 NDIR Gas Analyzers, Single-channel or Dual-channel Versions Order No. (PDF): E86060-K3510-B131-A3-7600	Catalog Extract PA 10		SITRAINonCD Course Information System for Automation and Drives Order No.: E86060-D6850-A100-B8-7400	ITC	
ULTRAMAT 23 NDIR Gas Analysers, one to three IR Channels plus Oxygen Order No.: E86060-K3510-B151-A4-7600	Catalog Extract PA 10		Automation and Drives The Entire Product Range on CD-ROM Order No.: E86060-D4001-A110-B8-7600	CA 01	
Process Analytics Component for Sample Preparation Order No.: E86060-D3511-A100-A5-7400	PA 11		A&D Mall Internet: www.siemens.de/automation/mall		
Field and Panel Instruments for Process Automation Order No.: E86060-D6201-A100-A2-7400					

Trademarks

MULTIREG, OXYMAT, PROFIBUS, SIEPID, SIMATIC, SIPAN, SIPART, SIREC, SITRAIN, SITRANS, ULTRAMAT and VARIOGRAPH are Siemens registered trademarks.

All other product or system names are (registered) trademarks of their respective owners and must be treated accordingly.

According to the German law on units in measuring technology, data in inches only apply to devices for export.

SIREC Recorders and Accessories

Catalog MP 20 · 2003

Supersedes:
Catalog MP 20 · 2001

The products listed in this catalog are
also included in the CD-ROM catalog CA 01
Order No.:
E86060-D4001-A110-B8-7600

Please contact your local
Siemens representative.

© Siemens AG 2003



The products and systems listed in this catalog are manufactured under application of a certified quality management system in accordance with DIN EN ISO 9001 (Certificate registration No. 19656-04). The certificate is recognized in all EQ Net countries.

SIEMENS

Introduction

1

Line and multipoint recorders
SIREC

2

Hybrid recorders
VARIOGRAPH

3

Spare parts, Accessories,
Consumable Material for
Older Design Recorders

4

Appendix

5

Welcome to Automation and Drives

We would like to cordially welcome you to Automation and Drives and our comprehensive range of products, systems, solutions and services for production and process automation and building technology worldwide.

With integrated automation blocks, powerful engineering tools and innovative concepts such as Totally Integrated Automation and Totally Integrated Power, we deliver solution platforms based on standards that offer you a considerable savings potential.

Discover the world of our technology now. If you need more detailed information, please contact one of your regional Siemens partners.

They will be glad to assist you.



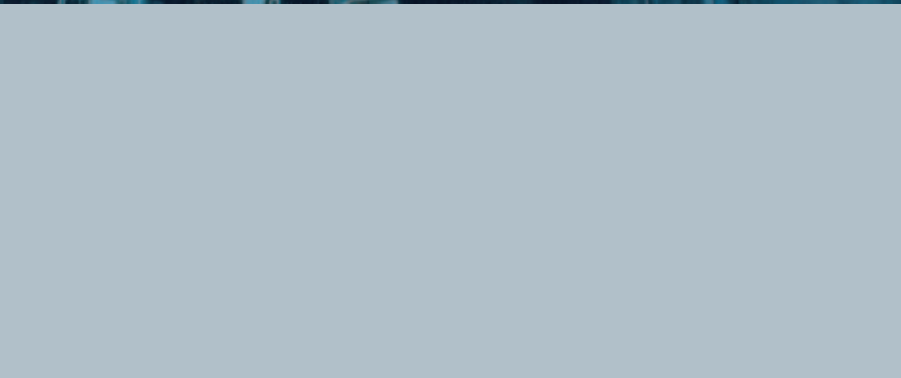

Totally Integrated Automation – innovations for more productivity

With the launch of Totally Integrated Automation in 1996, we were the first ones on the market to consistently implement the trend from equipment to an integrated automation solution, and have continuously perfected the system ever since.

Whether your industry is process- and production-oriented or a hybrid, Totally Integrated Automation is a unique common solution platform that covers all the sectors.

Totally Integrated Automation is an integrated platform for the

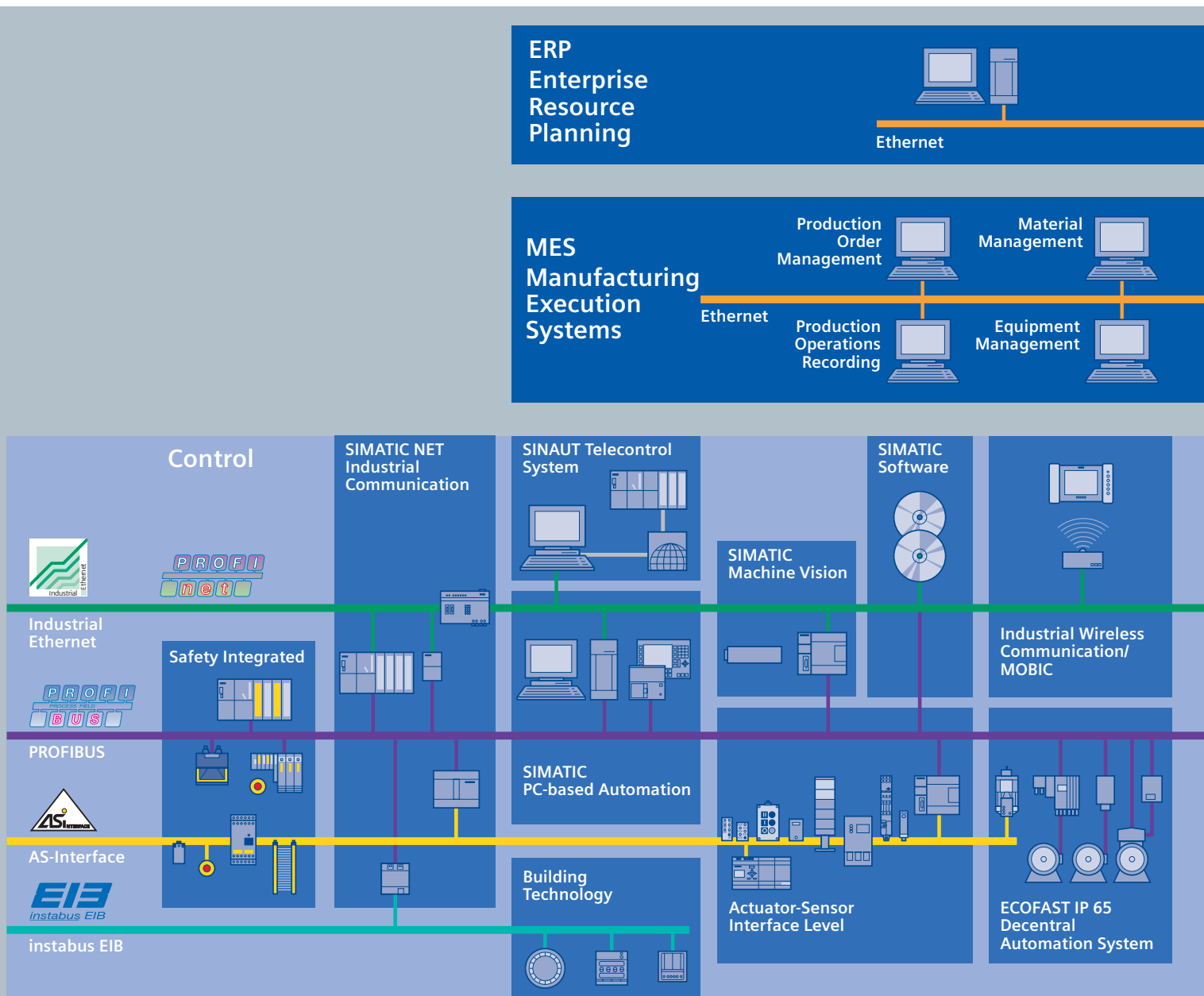

entire production line - from receiving to technical processing and production areas to shipping. Thanks to the system-oriented engineering environment, integrated, open communications as well as intelligent diagnostics options, your plant now benefits in every phase of the life cycle.

In fact, to this day we are the only company worldwide that can offer a control system based on an integrated platform for both the production and process industry.

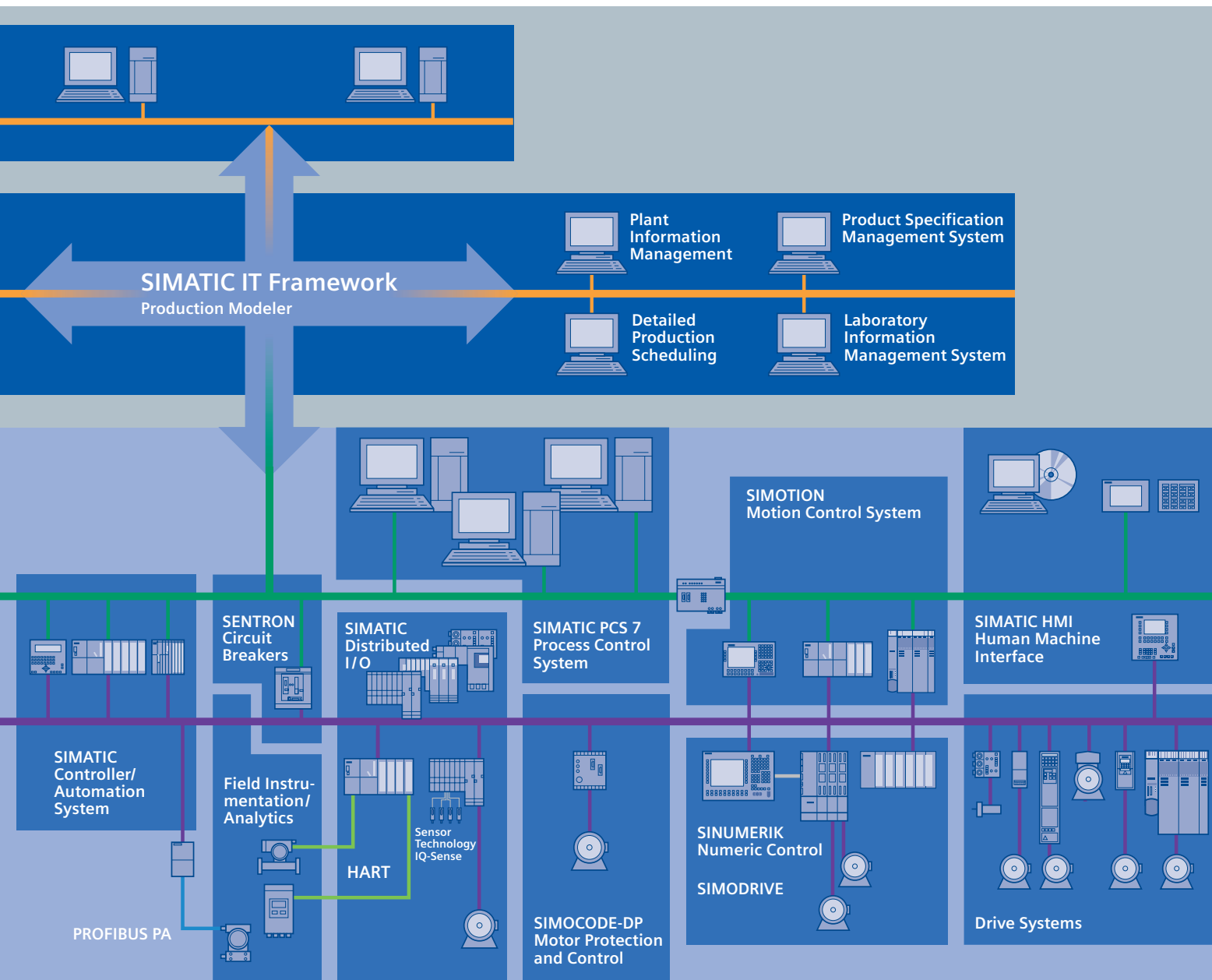

Totally Integrated Power – energy distribution and management from one source

Totally Integrated Power™ by Siemens offers integrated solutions for energy distribution in functional and industrial buildings covering everything from medium-high voltage to power outlets.

Totally Integrated Power™ is based on integration in planning and configuration as well as coordinated products and systems. In addition, it features communications and software modules for connecting power distribution systems to industrial automation and building automation, thereby offering a substantial savings potential.

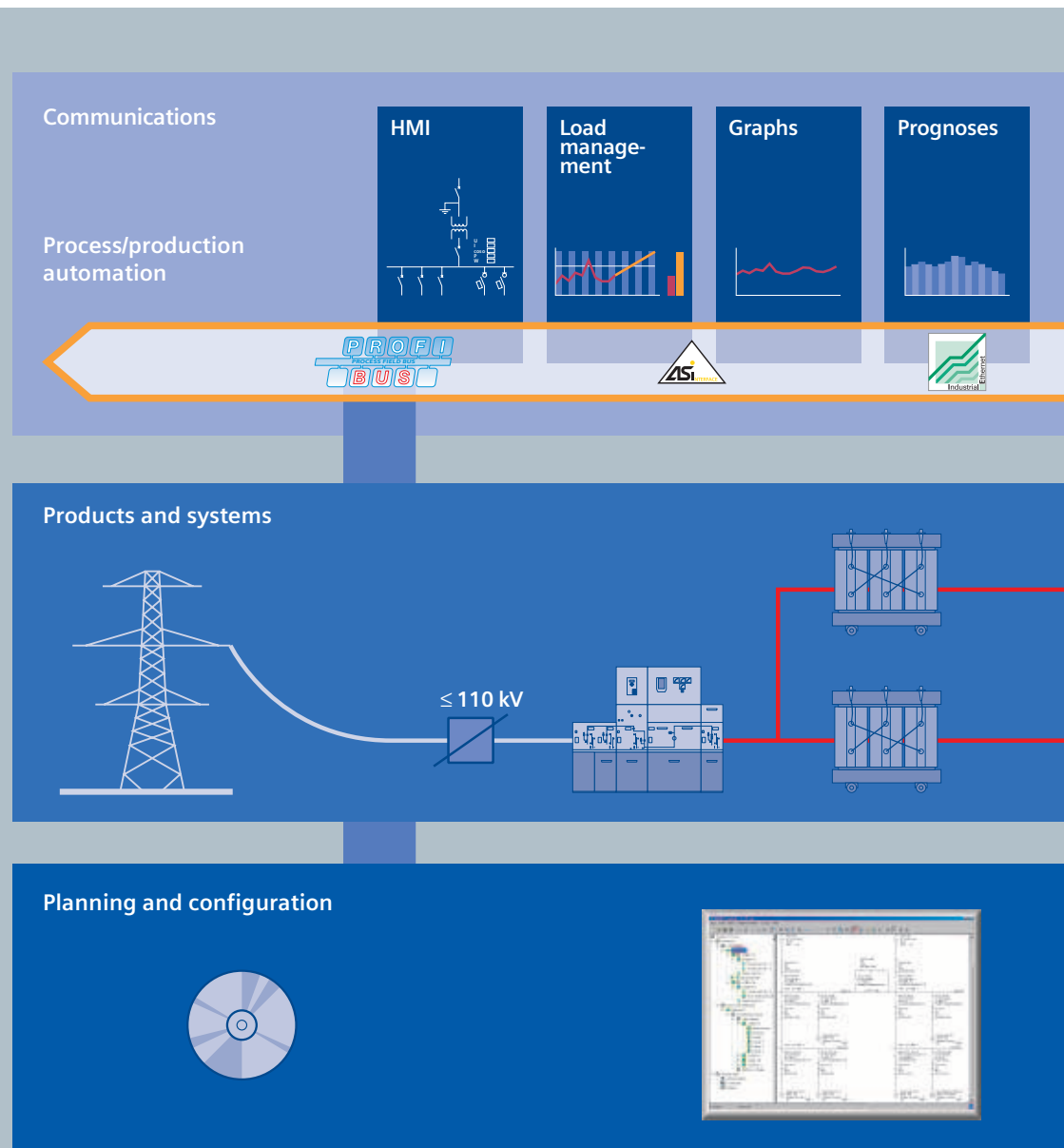

Maintenance

- Substation
- Distribution
- Maintenance task

Hall 1 Air conditioning system
checkup
Distribution 3 Replacing circuit
breaker contacts
Infeed II Replacing meters

Message/ error management



Selective protection



Protocols

Protocol	Application
BACnet	Building automation
KNX	Lighting and climate control
EIB	Energy management

Power quality

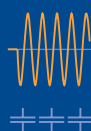

Cost center



Building
automation

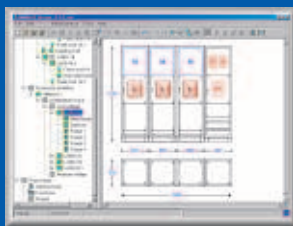
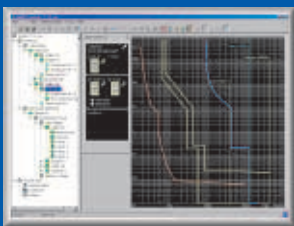
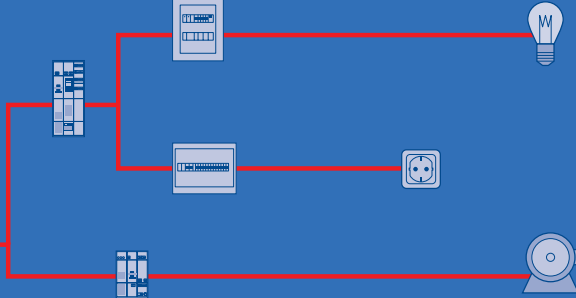

Process recorder - Reliable, field-tested and accurate.

No matter how special your measuring tasks may be, SIREC has the right chart recorder for you: sensibly graduated in performance and including everything from simple low-cost units to high-performance units and everything in between.

Continuous-line recorder, dotted-line recorder, or a hybrid, it's your choice.

SIREC continuous-line recorders are the best choice for quickly-changing measured variables such as current, voltage or pressure.

SIREC dotted-line recorders are the recorders of choice for measuring of slowly-changing variables such as temperature, pH value or level. These recorders are of a user-friendly design, with backlit display and wide reading angle.

The hybrid recorder is faster than dotted-line recorders or plotters. It can do virtually anything, which a continuous-line recorder can do, but has a larger number of channels, making it the most economical solution for the output of large amounts of text and tables.



SIMATIC PDM Software

SIMATIC PDM (Process Device Manager) is a consistent, manufacturer-independent software tool for the operation, configuration, parameterization, maintenance and diagnosis of intelligent field and control room instruments based on the worldwide leading EDD standard. It can be used independent of a specific automation system via PC or programming device or as an integral part of the SIMATIC PCS 7 process automation system.

The following core functions of SIMATIC PDM enable you to keep all instruments and automation processes under control:

- Set up and modification of parameter
- Comparison
- Plausibility checks
- Data management
- Commissioning functions

The SIREC L/LA/P/PA/PU and Variograph recorders are integrated in SIMATIC PDM. Therefore only a software to the parameter setting of all paper process recorders is required.

The known interconnecting cables are used for communication to the PC or programming device.

Technical data and order data for SIMATIC PDM is found within the FI01 catalog, chapter 8.

Line and multipoint recorders SIREC

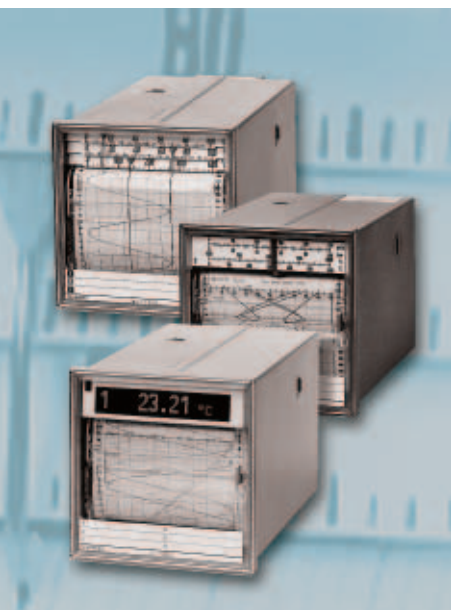

2/2	Summary of line recorders
2/2	Summary of multipoint recorders
2/4	Technical explanations
2/6	Ordering information
2/7	SIREC L/LA
2/7	Line recorder 144 x 144
2/17	SIREC P/PA
2/17	Multipoint recorder 144 x 144
2/24	SIREC PU
2/24	Multipoint recorder 144 x 144

SIMATIC PDM software
for parameterizing of
SIREC L/LA/P/PA/PU
see catalog FI 01

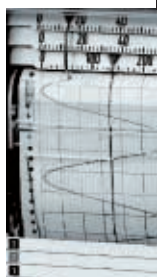

Line and multipoint recorders

Summary of line recorders

2

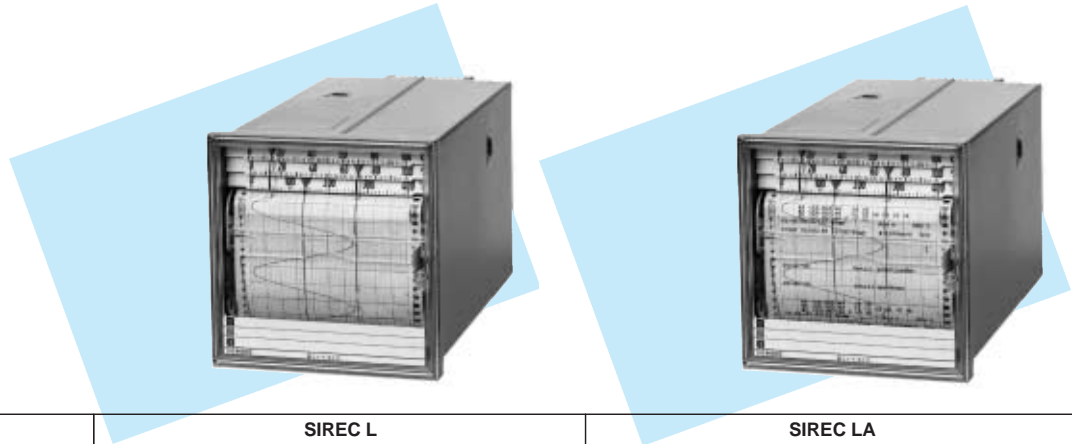

	SIREC L 7ND3121 Page 2/7	SIREC LA 7ND3125 Page 2/7
Format	144 x 144	
Class	0.5	
Microprocessor-based	■	
Analog inputs	1, 2 or 3	
Digital inputs/outputs	4/6	
Measured variable	U/I DC, temperature (thermocouple, resistance thermometer), resistance (2- or 3-wire)	
Measuring ranges	Freely-adjustable	
Operating modes	Curves	Curves, tables, texts, symbols
Recording method	Fiber pen	
Chart paper	Roll or fanfold pack	
Recording width	100 mm	
Number of colors	3	3 and black (for alphanumeric text)
Text printout	-	■
Date and time printout	-	■
Alarms	6, freely-programmable	
Alarm text	-	■
24 V DC output	■	
Zooming	■	
PC connection (software)	PC interface at front	
Interface	Digital input/output	
Power supply	AC 24 V, 115 or 230 V, DC 24 V	
Mounting	Sheet-steel panel, desk upright panel or cabinet, panel with 72 x 72 grid	
Installation without interspacing	■	

Line and multipoint recorders

Summary of multipoint recorders

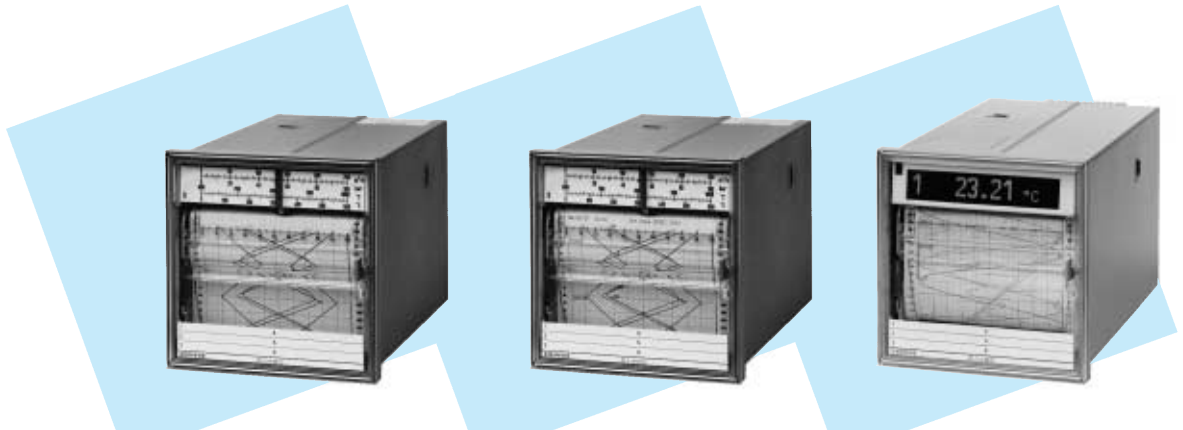

2

	SIREC P/PA 7ND3021 Without alphanumeric text Page 2/17	SIREC P/PA 7ND3021 With alphanumeric text Page 2/17	SIREC PU 7ND3523 Page 2/24
Format Class	144 x 144 0.5		
Microprocessor-based	■		
Analog inputs	6		
Digital inputs/output	4/6		4/6
Measured variables	U/I DC, temperature (thermocouple/resistance thermometer), resistance (2- or 3-wire)		U/I DC, temperature (thermocouple)
Measuring ranges	Freely-programmable		
Operating modes	Curves	Curves, tables, texts	Display, curves, tables, texts
Recording method	Fiber pen		
Chart paper	Roll or fanfold pack		
Recording width	100 mm		
Number of colors	6		
Text printout	-	■	■
Scale printout	-	-	■
Date and time printout	-	-	■
Alarms	6, freely-programmable		2 per channel
Math. functions	-		■
Alarm text	-		Per channel
Alarm linking	-		■
Zooming	-		■
Zoning	-		■
Remote operation	-		■
PC connection (software)	PC interface at front		
Line recorder function	Dot-joining		
Interface	Digital input/output		
Storage (short-term)	-		■
Power supply	AC 24 V, 115 or 230 V, DC 24 V		
Operator prompting	■		
Mounting	Sheet-steel panel, desk upright panel, cabinet, panel with 72 x 72 grid		
Installation without interspacing	■		

Line and multipoint recorders

Technical explanations

The range of flush-mounted recorders comprises two line recorders and three multipoint recorders with a standardized format of 144 x 144 mm.

Fiber pens are used for recording. The recorders are characterized by a robust design and programmable parameters. The recording is largely independent of the position, and the recorders are easy to service.

Recording method

With the fiber pen recording, the reservoir and fiber tip are combined in one assembly. Violet, red, black, green, blue and brown pens are available for the multipoint recorders, and blue, red, green and black (for alphanumeric text) pens for the line recorders.

Design

Front door
Plastic with catch or with catch and lock
Sheet-steel housing
Color: RAL 7037, dust gray

Front dimensions to DIN 43 831. Dimensions and panel cut-outs are specified with the respective recorders.

Error limits and interference suppression

The recorders comply with class 0.5 of the regulations for electrical measuring instruments. Any differences are listed in the Technical data.

The interference suppression St_U is specified in decibels. It is determined according to the following equation:

$$St_U = 20 \cdot \log_{10} \frac{U_{St}}{U_{Sig}} \text{ dB}$$

U_{St} Measured value of the interference signal
 U_{Sig} Determined value of the wanted signal

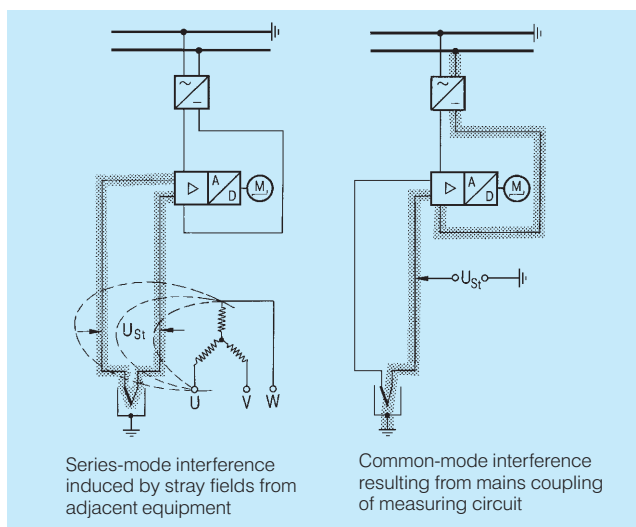

Fig. 2/1 Generation of interference signals

The worst condition is used in each case for the frequency and phase position of the interference. Since there are two manners in which the interference can affect the measuring circuit (common-mode or series-mode), two values in decibels are always required to completely specify the interference suppression.

The increasing energy density in modern plants means that it is advisable to suppress at least the induced series-mode interference at the point of occurrence (e.g. using commercially available contactors).

Limit monitoring

Limit monitoring functions output a binary signal when programmed limits are violated.

Up to 6 limits (opto isolator or relay outputs, freely-assignable) can be programmed.

Line recorders

The measured values are recorded as a continuous trace by fiber pens. Unsteady variables (e.g. pressure and flow) can be damped by a programmable filter (low-pass).

Multipoint recorders

The measured values for each channel are recorded as dots by a fiber pen (dotted line).

The individual measured values can be displayed as a continuous trace using a programmable dot-joining technique.

Input range

The input range is the electrical range of the instrument amplifier (measuring limits). The ranges are adapted using plug-in jumpers, and also by programming for certain ranges.

Example:

- a): - 20 mA to + 20 mA for DC I as measured variable
- b): - 100 mV to + 100 mV for TC, type J

The recording properties (measuring accuracy) of the instruments always refer to the input range.

Measuring range

Example:

- a): For DC U/I as measured variable:
Measuring range = input range
e.g.: - 20 mA to + 20 mA
- b): For direct connection of TC/RTD/R:
The measuring range is the range assigned to the input range (with linearization for TC and RTD).
e.g.: - 210 °C to + 1200 °C for TC, type J

Recording range

The recording range defines the part of the measuring range which is recorded over a width of 0 to 100 mm. The recording range is freely-programmable within the measuring range.

- Example a) Measuring range: -20 to +20 mA
 Recording range: +2 to +18 mA
 b) Measuring range: 10 to 300 °C
 Recording range: 20 to 180 °C

To permit easier operation, typical recording ranges are stored as "Fixed ranges".

- Examples: 0/4 to 20 mA
 0/2 to 10 V

Scale range

Easily-replaceable scales can be used to assign the scale range (graduation and dimension) to the recording range.

Standards

The recorders comply with the following standards:

- Housing: DIN 43 700, DIN 43 831
- Scales: DIN 43 790, 43 802
- Error limits: IEC 484 (DIN 43 782)
- Degree of protection: IEC 529 or EN 60 529
- Climate: IEC 68-2-1/2
- Mechanical stress: IEC 68-2-6
- Electric protection: IEC 1010-1 (EN 61 010-1, VDE 0411 Part 1)
- Electromagnetic compatibility: the protection objectives of the EMC guideline 89/336/EEC with respect to interference suppression to EN 50 081-1 and noise immunity to EN 50 082-2 of 03/95 are complied with.
- Interference suppression: VDE 0875 Part 11 (CISPR 11)
- Noise immunity: IEC 1000-4-...

Chart drive

A program-controlled stepping motor is responsible for the time-synchronous chart drive. The drive controls a sprocket wheel, and the sprockets engage in the perforations of the chart paper and thus transport the latter.

The chart paper is tightened in the longitudinal direction by a take-up spool driven by the drive via a slip coupling.

Time marking

For recorders without a text output, program-controlled time markers are recorded on the right edge of the chart every hour. The set chart speed can then be determined when evaluating the recording.

For recorders with a text output, the time is printed out at the left edge of the recording by means of the real-time scale clock.

Chart paper

Chart paper for line and multipoint recorders.

The absorptive capacity of the ink paper is optimally matched to fiber pens and recording heads. The paper has a very smooth surface so that the frictional resistance of the fiber pens is low.

Types of chart paper

Roll: low-price recording with greatest possible visible trace length.

Fan fold: fast access possible even to recordings made a long time earlier. Easy finding of specific positions by flipping through like in a book.

Chart paper graduations (see Fig. 2/2 for example)

Range graduation

The recording width is divided linearly by longitudinal lines. Every fifth line is thicker than those in between.

Please contact us if you require chart paper with a non-linear range graduation or with printed text at regular intervals - e.g. range numbers, dimensions and measuring point names.

Blank chart paper can also be used for the SIREC LA and P/PA.

Time graduation

The line and multipoint recorders are supplied with chart paper with a time graduation, but without the printing of hours.

Blank chart paper can also be used for the SIREC LA and P/PA.

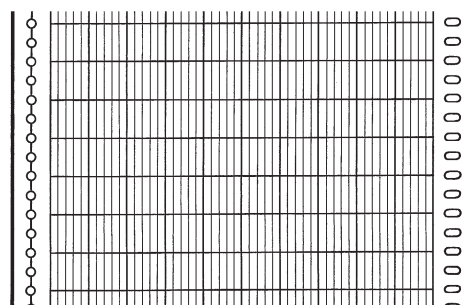

Fig. 2/2 Chart paper 120 mm wide, recording width 100 mm, 50 linear divisions (scale approx. 1:2)

Parameterization software

The SIMATIC PDM software permits you to use your PC for convenient dialog with the line and multipoint recorders.

Line and multipoint recorders

Ordering information

Ordering information

Standard models are listed in the Ordering data. The technical data contain additional data for further designs, e.g. applications and power supply.

If designs are required for which no information is included in the technical data, please inquire whether the desired model is technically possible.

When ordering, please state:

- Order No.
- Order code, if applicable, according to table or as plain text (supplement Order No. with "-Z" in this case)
- Any plain text required for inscription of measuring point label or information on the recording ranges and scale graduations.

Recorders can also be delivered with measuring ranges other than those offered. However, the input ranges of these recorders must lie within the technical limits of the associated recorder.

Example for ordering:

Required recorder:

SIREC L line recorder 7ND3121

Format 144 x 144

For installation in sheet-steel panel

Power supply AC 50 Hz, 220 to 240 V

3 channels

Channel 1: Recording range DC 0 to 1 V,
scale 0 to 100 %, direct connection

Channel 2: 0 to 300 °C
Sensor: Pt 100 resistance thermometer,
connection via transmitter,
output (recording range) DC 0 to 20 mA,
temperature-linear

Channel 3: Recording range DC 4 to 20 mA,
scale 30 to 80 bar

6 electronic alarm outputs

Measuring point label inscribed "Water pump" (channel 1),
"Inlet temperature" (channel 2), "Boiler pressure" (channel 3)

The Ordering data for this recorder must then be as follows
(according to pages 2/13 and 2/15):

Order No.: 7ND3121-1CA21-3NA9-Z

Order codes: R1Y + Y05 + Y01 + Y02

Plain text: Scale graduation:

Channel 1: 0 to 100 %

Channel 2: 0 to 300 °C

Channel 3: 30 to 80 bar

Measuring point inscription:

Channel 1: Water pump

Channel 2: Inlet temperature

Channel 3: Boiler pressure

Note:

The following designations are used in this section for the signal modules/measured variables:

DC U/I: DC voltage/direct current

RTD: Resistance temperature detector (resistance thermometer)

TC: Thermocouple

R: Resistance

Line and multipoint recorders

SIREC L/LA

Line recorder 144 x 144

Microprocessor-based
line recorder 144 x 144
Single-channel, dual-channel or
three-channel recorder, class 0.5
With fiber pen recording
Input variables DC U/I/TC/RTD/R

SIREC L (7ND3121)
Without text output

SIREC LA (7ND3125)
With text output

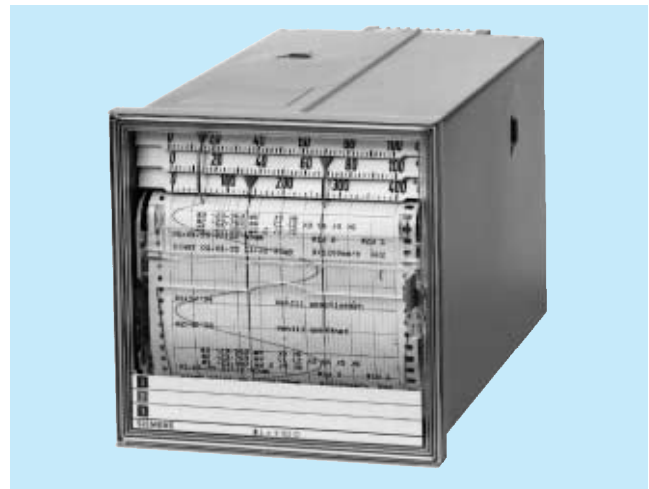

Fig. 2/3 SIREC LA

2

Features

General:

SIREC L/LA

- Operating modes:
 - Measure, display (three scales), record
- Pen lift with pauses in operation, also in event of power failure
- Pens easily replaceable from the front
- Limit monitoring:
 - Alarm identification and output with limit violations, freely-adjustable and freely-assignable to the channels
- Time marking
- Input/output module: 4 inputs, 6 outputs electrically isolated; electronic outputs or relays
- Floating DC 24 V output for supply of input/output module or transmitter
- CE symbol, NAMUR and KTA requirements complied with; permits use under all conditions
- Housing front with degree of protection IP 54
- Installation without interspacing possible
- Mounting depth including connections 260 mm

In addition with SIREC LA

- Real-time calendar/clock
- Summer time/winter time switchover
- Output of error messages, instrument text

Measure:

SIREC L/LA

- 1, 2, 3 analog channels and 2 digital channels
- Channel isolation: semiconductor relays, floating
- Measuring cycle 150/240 ms or 180/300 ms according to measuring ranges
- Measured variables (free selection possible):
 - Direct current, DC voltage
 - Temperature via thermocouple or resistance thermometer
 - Resistance transmitter (two-wire or three-wire system)
 - 2 digital channels (only with SIREC LA)

- Measuring ranges freely selectable with the range limits
- High measuring accuracy

Display:

- One scale plate and pointer for measured values for each channel, easy readability
- LED status display (NAMUR)

Record:

SIREC L/LA

- Recording with fiber pens, max. 3 colors
- Adjustable chart speed
- Curve display
- Zooming (scale expansion)
- Event marking
- Chart paper: roll or fanfold
- Formamide-free ink, large reservoir

In addition with SIREC LA

- Alphanumeric output with additional fiber pen
- Chart paper: also grid-free chart, grid is generated (in 8 steps)
- Alphanumeric output:
 - date, time, start/stop line, channel code, alarms, 6 event texts (with 16 characters each), measured-value table and parameter printout
- Limit lines assignable for every alarm

Adjustment/operation:

- All adjustments and operations using levers at front and via the PC interface (SIMATIC PDM software)
- Settings are saved by the non-volatile memory (EEPROM)

Line and multipoint recorders SIREC L/LA

Line recorder 144 x 144

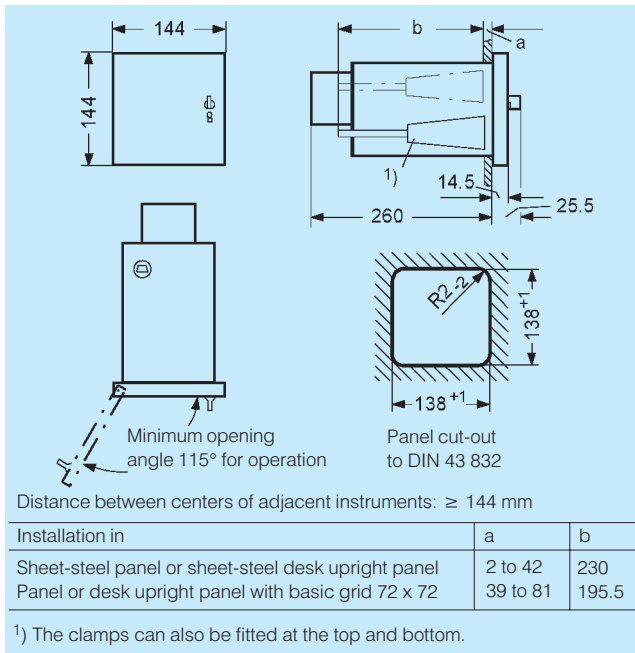

Fig. 2/4 Dimensions

Technical data		
Note: Only values with tolerances or limits are guaranteed data. Values without tolerances are informative data. The defined error limits apply following a warming-up time of 30 minutes.		
Measuring functions		
General data		
Number of channels	analog digital (only with LA)	1, 2 or 3 2 (see digital input/output)
Channel isolation		Electrically isolated via semiconductors
Voltage endurance		See Table "Interference rejection" (page 2/10), protect. with varistors from protective earth conductor
Permissible potential		Max. DC 24 V compared to PE conductor; only measuring circuits with safe isolation from power supply are permissible
Input overload		Max. 10 % of full-scale value
Overload		Max. 24 V continuously in DC U range, max. 40 mA continuously in DC I range
A/D conversion		Dual-slope converter
Resolution		14 1/2 bits
Common-mode rejection		90 dB at 50 Hz
Series-mode rejection		60 dB at 50 Hz
Reference conditions		
Ambient temperature		23 ± 2 °C
Relative humidity		55 ± 10 %
Source resistance		≤ 1 k Ω
Potential difference		≤ 1 V
Adjustment interval		≤ 24 months; an additional error of 0.01 %/year must be expected with a longer interval
Measured value calibration		
		Class 0.5 to DIN 43 782 or IEC 484
Damping		1st order low-pass, 0, 1, 3, 10, 30, 100 s or automatic adaptation to chart speed

- 1) The specified values apply to the normal measuring cycle, they must be doubled for the fast cycle; the offset error F_{offset} becomes approx. 30 % larger.
- 2) Linearization range = measuring range with thermocouples with slightly increased error at start-of-scale including overload range.
- 3) Measuring error F_{offset} (zero error) = absolute value specified in table F_{rel} (increasing error) = percentage specified in table multiplied by the value of the read measured value (% · |MV|)

Measuring range/ linearization range ²⁾	Reso- lution Normal cycle ¹⁾	Maximum electric measuring error ³⁾ $F_{\text{el}} = F_{\text{offset}} + F_{\text{rel}} + F_{\text{temp}} + F_{\text{terminal}}$ (typ. 1/3 of max. measuring error)			
		F_{offset}	F_{rel}	F_{temp}	F_{term}
-40 to +40 mV	4 μ V	16 μ V	0.05	0.02 + 0 mV	-
-100 to +100 mV	10 μ V	30 μ V	0.05	0.02 + 0 mV	-
-400 to +400 mV	40 μ V	120 μ V	0.05	0.02 + 0 mV	-
-1000 to +1000 mV	100 μ V	300 μ V	0.05	0.02 + 0 mV	-
-1 to +1 V	0.1 mV	0.3 mV	0.05	0.02 + 0 mV	-
0 to +1 V	0.1 mV	0.3 mV	0.05	0.02 + 0 mV	-
+0.2 to +1 V	0.1 mV	0.3 mV	0.05	0.02 + 0 mV	-
-10 to +10 V	1 mV	3 mV	0.05	0.02 + 0 mV	-
0 to +10 V	1 mV	3 mV	0.05	0.02 + 0 mV	-
+2 to +10 V	1 mV	3 mV	0.05	0.02 + 0 mV	-
-20 to +20 mA	2 μ A	6 μ A	0.05	0.02 + 0 mA	-
0 to +20 mA	2 μ A	6 μ A	0.05	0.02 + 0 mA	-
+4 to +20 mA	2 μ A	6 μ A	0.05	0.02 + 0 mA	-
J (Fe/CuNi) -100 to +1200 °C/ -210 to +1200 °C	0.2 °C	0.6 °C	0.06	0.02 + 0 °C	0.8 °C
K (NiCr/Ni) -100 to +1370 °C/ -270 to +1370 °C	0.3 °C	0.8 °C	0.06	0.02 + 0 °C	0.8 °C
R (Pt13Rh/Pt) +100 to +1760 °C/ -50 to +1760 °C	0.5 °C	1.8 °C	0	0.01 + 0.2 °C	0.6 °C
T (Cu/CuNi) -100 to +400 °C/ -270 to +400 °C	0.2 °C	0.6 °C	0.07	0.02 + 0 °C	0.8 °C
S (Pt10Rh/Pt) +100 to +1760 °C/ -50 to +1760 °C	0.5 °C	1.8 °C	0	0.01 + 0.2 °C	0.6 °C
N (NiCrSi/NiSi) -100 to +1300 °C/ -200 to +1300 °C	0.4 °C	1 °C	0.05	0.02 + 0 °C	0.8 °C
E (NiCr/CuNi) -100 to +1000 °C/ -270 to +1000 °C	0.15 °C	0.5 °C	0.06	0.02 + 0 °C	0.8 °C
B (Pt30Rh/Pt6Rh) +600 to +1820 °C/ +100 to +1820 °C	0.6 °C	2 °C	0	0.01 + 0.2 °C	0.4 °C
L (FeCu/Ni) -100 to +900 °C/ -200 to +900 °C	0.2 °C	0.6 °C	0.06	0.02 + 0 °C	0.8 °C
U (Cu/CuNi) -100 to +560 °C/ -200 to +560 °C	0.2 °C	0.6 °C	0.07	0.02 + 0 °C	0.8 °C
0 to 300 Ω	0.03 Ω	0.2 Ω	0.07	0.02 + 0.02 Ω	-
0 to 1000 Ω	0.1 Ω	0.5 Ω	0.07	0.02 + 0.04 Ω	-
Pt 100 -200 to +800 °C/ -200 to +800 °C	0.08 °C	0.5 °C	0.05	0.02+0.05 °C	-
Ni 100 -60 to +180 °C/ -60 to +180 °C	0.05 °C	0.25 °C	0.07	0.02+0.025 °C	-

Note:

A special calibration from a service place is recommended for a large stretching of the measuring ranges.

F_{temp} (temperature error at an increased ambient temperature) = percentage specified in table multiplied by the value of the absolute measured value (% · |MV|) plus a constant specified as an absolute value, total multiplied by the value of the temperature difference between the reference value 23 ± 2 °C and the ambient temperature.
 F_{terminal} (error of terminal temperature measurement) = absolute value specified in table for additional error with direct connection of thermocouples.

Line and multipoint recorders

SIREC L/LA

Line recorder 144 x 144

2

Input resistance	10 M Ω in the TC/DC U range at \leq 100 mV; 100 k Ω in the DC U range at 1 and 10 V; 50 Ω in the DC I range
Measuring mode	
Measuring cycle, adjustable	
- DC U/I	240 ms/150 ms
- DC U/I/TC/RTD/R	300 ms/180 ms
Measuring duration	40 ms (50 Hz), 33 1/3 ms (60 Hz)
Type of connection for resistance measurements	Two-wire or three-wire system
Signal connection (see Fig. 2/5)	2 or 3 screw terminals/channel
Terminal range	0.13 to 2.5 mm ² solid conductor 0.13 to 1.5 mm ² stranded conductor with sleeves; Terminal designations to DIN 45 140
Operation, displays	
Display	Scale and pointer for measured values, green LED for display of recorder readiness, red LED for display of programming and test status
Operation	2 levers for function settings, 2 levers for service (mechanical release)
PC interface	For all settings and measured-value scanning
Connection	2-pin plug at front, connection to PC via special cable (accessory)
Real-time clock (SIREC LA)	
Format	Year, month, day, hour, minute, second; 12/24-hour representation, summer/winter time switchover
Deviation	Max. $1 \cdot 10^{-5}$
Backup	Via capacitor in event of power failure (approx. 5 min) or via battery (approx. 36 months)
Recording	
Chart drive	Step motor
Chart speeds A, B	1 - 1.25 - 2.5 - 5 - 10 - 20 - 60 - 120 - 300 - 600 - 1200 mm/h
Analog recording system	
Recording system	Replaceable fiber pens
Pen spacing	1.5 mm (in chart direction)
Colors	Red, green, blue
Recording length	Approx. 1800 m
Service period	Approx. 6 months
Storage life	Approx. 24 months in closed packing, approx. 1 month in recorder with climate to DIN IEC 654-1
Pen assembly drive	Program-controlled step motor
Resolution	0.108 mm
Carriage speed	Max. 40 mm/s
Recording width	100 mm
Recording system error	$F_{\text{mech}} \leq 0.35 \%$
Text recording system (SIREC LA)	
Recording system (can only be used up to 120 mm/h)	Replaceable fiber pen
Character height	Approx. 2.4 mm or 2.8 mm with descenders
Characters/line	51
Character set	ASCII standard with upper-case and lower-case letters, Greek alphabet, special characters, binary signals, limit lines etc.
Grid (for grid-free chart paper)	Adjustable in 8 steps
Color	Black

Recording length	Approx. 100 000 characters
Service period	Approx. 6 months
Storage life	Approx. 24 months in closed packing, app. 1 month in recorder with climate to DIN IEC 654-1
Pen assembly drive	Program-controlled step motor
Speed	Approx. 0.4 characters/s
Limit monitoring	6 alarms, free assignment of channels
Alarm output	MIN or MAX can be set Recording of a symbol in event of upward or downward violation of a limit
Limit hysteresis	2 % of recording range
Digital input/output	
Digital inputs	4, electrically isolated via opto isolators, passive
Switching level	Low: -3 to +5 V, High: +8 to +30 V
Signal duration	≥ 0.5 s
Input resistance	≥ 5 k Ω
Functions	2 digital channels, measuring mode "Normal/Fast" each with "On/Off", chart speeds A/B, chart feed 10 to 100 mm, time marker, interlocking With SIREC LA: clock synchronization, summer time/winter time, input interlocking, event text, measured-value tables With SIREC L: event marking on all channels (peak approx. 3 mm)
Digital outputs	6
Electronic version	Electrically isolated via opto isolators, semiconductor switches, short-circuit-proof, open collector, P-switching
Output current	Max. 150 mA
Switching level	High ext. voltage ≥ -2 V
Ext. power supply	DC 18 to 30 V
Relay version	Electrically isolated via relays, floating switchover contacts
Switching voltage/current	50 V, 1 A (external voltage)
Switching capacity	30 V or 60 VA
Contact life	1×10^8 mechanical 3×10^6 at max. load
Permissible potential	50 V
Connections	Subminiature plug, 25-pin, lockable
Power supply	
AC power supply	
Mains voltage	AC 230/115 V +15 to -20 % AC 24 V +15 to -20 %
Frequency range	47 to 64 Hz
Power consumption	20 VA (with options) at rated voltage
DC power supply	
Rated voltage	DC 24 V +20 to -15 %
Power consumption	15 W (with options) at rated voltage
DC 24 V output	DC 24 V $\pm 15 \%$, 75 mA, short-circuit-proof Capacitive load ≤ 33 μ F
Ambient conditions	
Climate	To IEC 68/2-1/2/ DIN EN 60 068-2-1/2
Temperature of use	0 to 50 °C (max. 75 % rel. humidity at 25 °C, no condensation), change in temp. max. 10 K/h

Line and multipoint recorders SIREC L/LA

Line recorder 144 x 144

Storage temperature range	-25 to +70 °C (max. 75 % rel. humidity at 25 °C, no condensation), change in temperature max. 20 K/h			
Mechanical				
Vibrations during operation	To DIN IEC 68-2-6 5 to 9 Hz; 3.5 mm deflection 9 to 200 Hz; 10 m/s ² acceleration			
Vibrations during storage and transport	To DIN IEC 68-2-6 5 to 9 Hz; 3.5 mm deflection 9 to 500 Hz; 10 m/s ² acceleration			
Drop test for packed unit	To DIN EN 60 068-2-32, height < 0.8 m			
Shock test during operation	To IEC 68-2-27/ DIN EN 60 068-2-27 Half-sine: 150 m/s ² (15 g), 11 ms			
Resistance to earthquakes during operation	Parameters to KWU AVS DD 7080.9; 5 to 35 Hz; max. 10 mm deflection, max. 15 m/s ² acceleration			
Electromagnetic compatibility				
Emitted interference The targets of the EMC guideline 89/336/EEC with respect to radio interference suppression to EN 50 081-1 and interference rejection to EN 50 082-2, as well as NAMUR recommendation NE 21 are observed.				
Radio interference	Limit class B, measured according to VDE 0875 Part 11 (CISPR 11)			
Interference rejection				
Device-under-test	Influencing variable	Basic standard	Instrument	
			Test condition	Res ²⁾
Instrument	RF field AM	IEC 1000-4-3	10 V/m ¹⁾	A
	RF field PM	IEC 1000-4-3	10 V/m	A
	Mag. field	IEC 1000-4-8	³⁾	-
	Discharge	IEC 1000-4-2	6/8 kV	A
Process, measuring and control lines	RF conducted interference	IEC 1000-4-6	10 V	A
	Burst	IEC 1000-4-4	2 kV	A
	Surge	IEC 1000-4-51	1/2 kV ⁴⁾	B
DC power inputs	RF conducted interference	IEC 1000-4-6	10 V	A
	Burst	IEC 1000-4-4	2 kV	A
	Surge	IEC 1000-4-5	1/2 kV ⁴⁾	A
	Interruption	IEC SC77BWG3	20 ms/100 %	A
	In-rush current	-	≤ 15 I _{rated}	-
AC power inputs	RF conducted interference	IEC 1000-4-6	10 V	A
	Burst	IEC 1000-4-4	2 kV	A
	Surge	IEC 1000-4-5	1/2 kV ⁴⁾	A
	Interruption	IEC SC77BWG3	20 ms/100 %	A
	In-rush current	IEC 1000-3-3	≤ 15 I _{rated}	-
	Overshoots	IEC 1000-3-2	Class D	-
Earth connection	RF conducted interference	IEC 1000-4-6	10 V	A

Mounting position	To DIN 16 257
Operation with roll	Vertical -30 to +15°
Operation with fanfold	Vertical -15 to +15°
Degree of protection	To IEC 529 or EN 60 529
Front with door	IP 54
Terminals, interfaces, plug connectors	IP 20
Electric safety	According to low-voltage guideline 73/23/EEC to EN 61010-1, overvoltage category II, degree of contamination 2 (IEC 1010-1, VDE 0411 Part 1)
Dimensions, mounting	
Dimensions	Front dimensions 144 x 144 to DIN 43 700 and DIN 43 831 (see Fig. 2/4)
Mounting	
Panel mounting	To DIN 43 834-A-340
Desk and cabinet mounting	To DIN 43 834-A-330
Front door	Plastic, spring-loaded latch
Weight	Approx. 4 kg

¹⁾ 3 V/m in the ranges 87 to 108, 174 to 230 and 470 to 790 MHz

²⁾ Response A = class accuracy retained during effect

Response B = interference possible during effect

- = not relevant

³⁾ Not relevant because of measuring and recording procedure used

⁴⁾ 1 kV symmetric, 2 kV asymmetric

Line and multipoint recorders SIREC L/LA

Line recorder 144 x 144

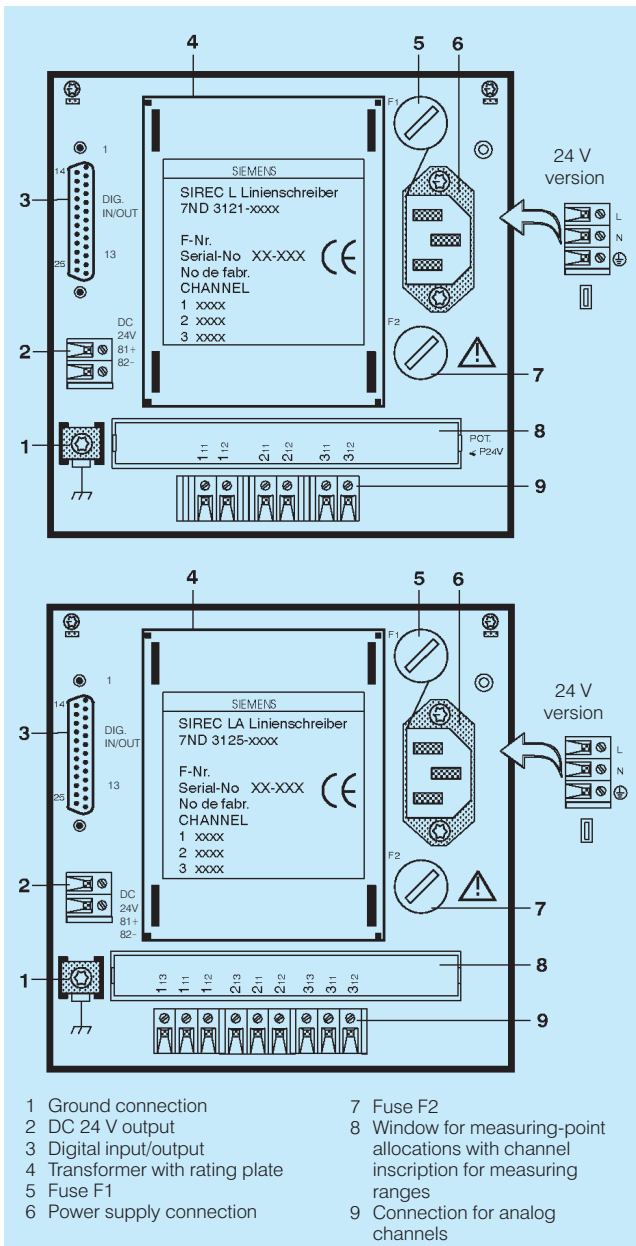
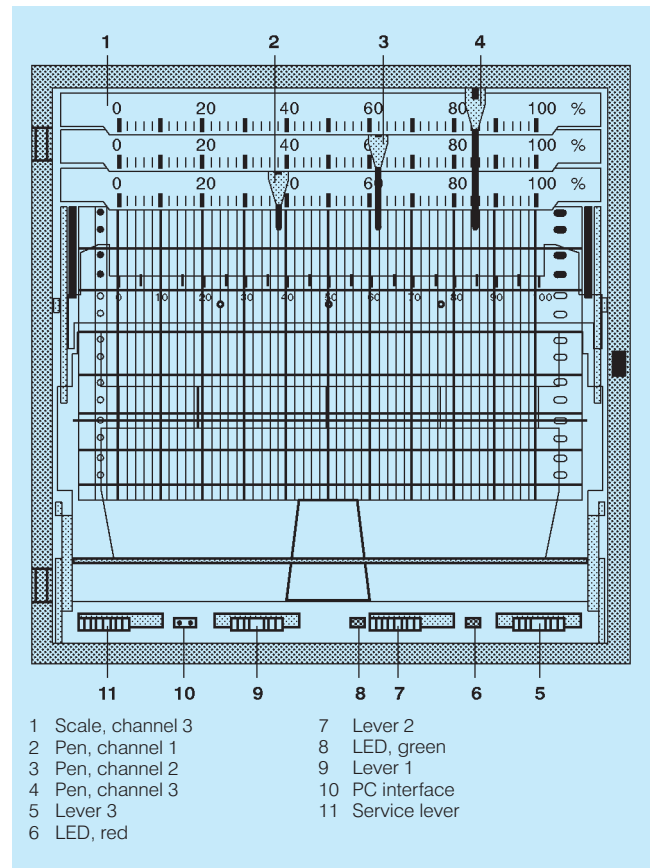

Fig. 2/5 Rear view of SIREC L (top) and LA (bottom)

- | | |
|---------------------------------|--|
| 1 Ground connection | 7 Fuse F2 |
| 2 DC 24 V output | 8 Window for measuring-point allocations with channel inscription for measuring ranges |
| 3 Digital input/output | 9 Connection for analog channels |
| 4 Transformer with rating plate | |
| 5 Fuse F1 | |
| 6 Power supply connection | |



- | | |
|--------------------|------------------|
| 1 Scale, channel 3 | 7 Lever 2 |
| 2 Pen, channel 1 | 8 LED, green |
| 3 Pen, channel 2 | 9 Lever 1 |
| 4 Pen, channel 3 | 10 PC interface |
| 5 Lever 3 | 11 Service lever |
| 6 LED, red | |

Fig. 2/6 Front view of SIREC L/LA

Single-channel recorder

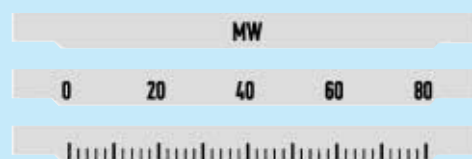

Dual-channel recorder

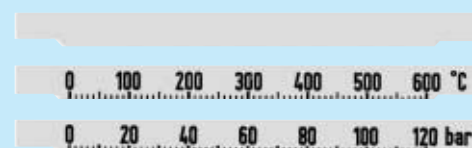

Three-channel recorder



Fig. 2/7 Scale versions

2

Line and multipoint recorders SIREC L/LA

Line recorder 144 x 144

2

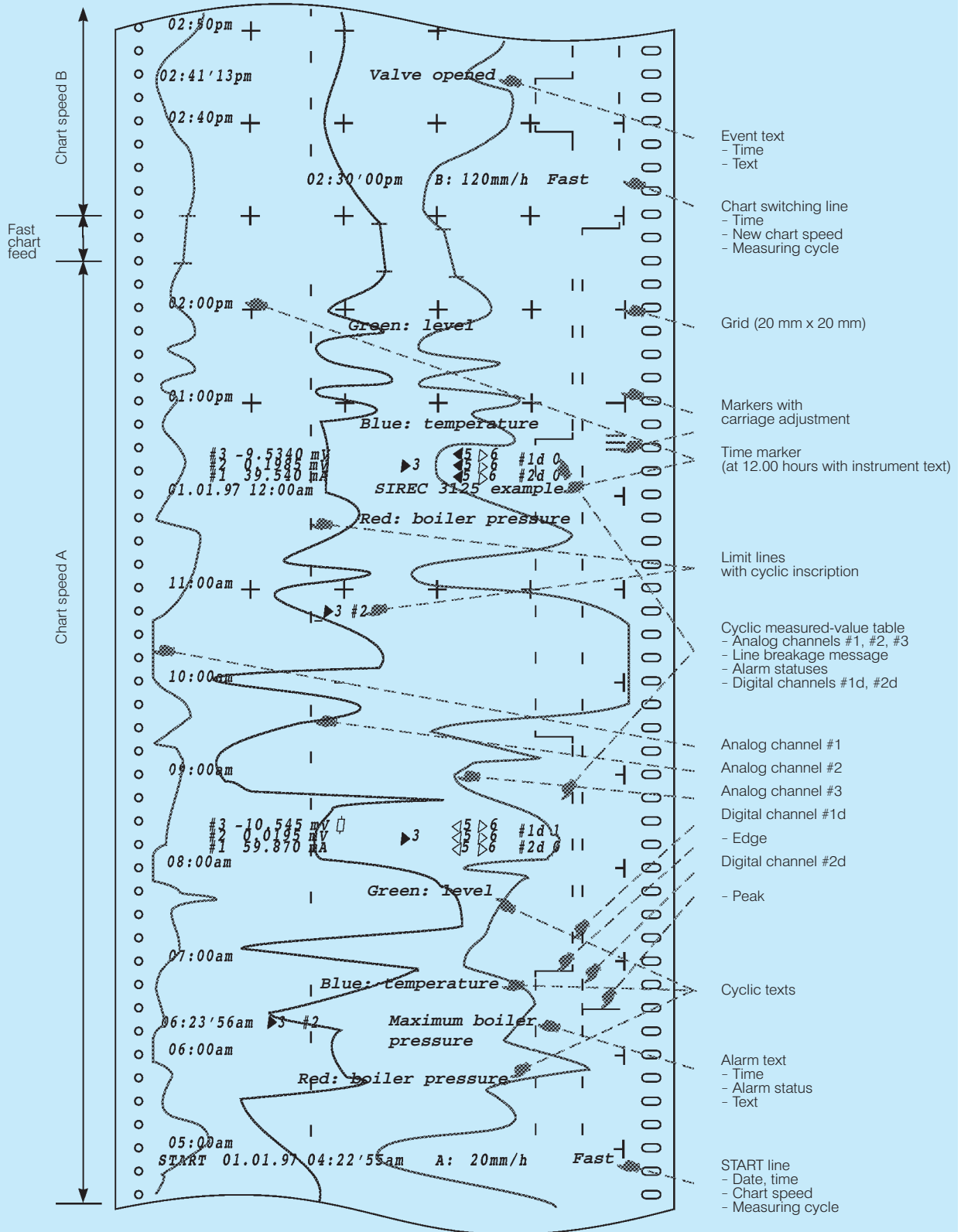

Fig. 2/8 Example of graphic recording with SIREC LA (80 % of original size)

Line and multipoint recorders

SIREC L/LA

Line recorder 144 x 144

Ordering data		Order No.	Order code	Price
Recorders available ex stock				
SIREC LA with text output ³⁾ Front dimensions 144 mm x 144 mm With recording unit for rolls or fanfold paper Three-channel line recorder ¹⁾			7ND3125-1 C B 1 1 - 1 N A 1	
SIREC LA with text output Single-, dual- or three-channel line recorder ¹⁾ , front dimensions 144 mm x 144 mm For installation in sheet-steel panel, cabinet or desk upright panel With recording unit for rolls or fanfold paper				
Power supply	AC 47 to 64 Hz 220 to 240 V AC 47 to 64 Hz 110 to 127 V AC 47 to 64 Hz 24 V DC 24 V			
Number of channels	1, trace red 2, traces red and blue 3, traces red, blue and green			
Measured variables	DC U/I/TC/RTD/R DC U/I/TC/RTD/R, with DC 24 V output			
Digital input/output	Without With digital input, electronic output With digital input, relay output			
Installation	In sheet-steel panel, cabinet or sheet-steel desk upright panel, with 2 clamps C72165-A405-B176 In panel or desk upright panel with basic grid dimension 72 x 72, with one set of mounting parts C79453-A3011-D101			
Recorder setting	All channels set to 4 to 20 mA, scale(s) 0 to 100 % According to Order code ²⁾ (see page 2/15)			
Measuring-point label	Unlabelled Labelled (max. 29 digits/channel); specify desired inscription in plain text:			

Further designs on request.

Accessories, consumable material and conversion parts on page 2/15 ff

Scope of delivery

SIREC LA line recorder 7ND3125 as ordered, 1 roll of chart paper, 1 accessories bag (1 to 3 fiber pen assemblies as ordered, 1 fiber pen assembly for alphanumeric output, 2 fuses), 1 appliance plug (with AC 230 or 115 V version), 2 clamps, 1 plug connector (with digital input/output), 1 measuring-point label, 1 ruler per scale, unpacking instructions, installation instructions, instructions "Operation - a concise overview", instructions "Parameterization - a concise overview", 1 battery (fitted).
 When using several SIREC LA recorders it is sometimes only necessary to have one Manual. This is therefore not included in the delivery and must be ordered separately.

¹⁾ Basic setting when delivered:

The program interlock in the test menu is set such that all inputs are possible using the levers on the front of the instrument. The levers can be disabled at any time to permit customer-specific parameterization. The measured-value damping is set to "0 s" for all channels. The noise suppression is set for AC 50 Hz (switchable to AC 60 Hz).

²⁾ An order code is required for each channel (sequence: channel 1, 2, 3).

Example: Three-channel line recorder for mounting in cabinet, power supply AC 230 V, recording range DC 0 to 10 V for each channel, without digital input/output, all scales 0 to 5 t, measuring-point label inscribed

Order as follows:

7ND3125-1CB11-4NA9-Z

R1Y + Y06 + Y06 + Y06

Each scale 0 to 5 t

In addition, plain text for inscription of measuring-point label (max. 29 digits/channel)

³⁾ Text output only recommended up to 120 mm paper feed.

Line and multipoint recorders SIREC L/LA

Line recorder 144 x 144

Order codes																				Price		
Recording range	Measured variables								Direct connection of sensor										Acc. to plain text ¹⁾			
	DC I (mA)				DC U (V)				Type of TC ³⁾											RTD		
	0 to 20	4 to 20	0 to 1	0 to 10	0 to 1	0 to 10	0,2 to 1	2 to 10	J	L	T	U	K	N	E	S	B	R		Pt 100 ²⁾	Ni 100 ²⁾	
According to plain text	Y01	Y02	Y03	Y04	Y05	Y06	Y07	Y08	Y10	Y11	Y12	Y13	Y14	Y15	Y16	Y17	Y21	Y22	Y18	Y19	Y20	

Ordering data	Order No.	Price
Accessories		
Manual ⁵⁾		
German	C79000-G7300-C188	
English	C79000-G7376-C188	
French	C79000-G7377-C188	
Spanish	C79000-G7378-C188	
Italian	C79000-G7372-C188	
Installation Instructions ⁵⁾	C79000-M7364-C193	
Instructions		
"Operation - a concise overview"		
German	C79000-M7300-C192	
English	C79000-M7376-C192	
French	C79000-M7377-C192	
Spanish	C79000-M7378-C192	
Italian	C79000-M7372-C192	
Instructions "Parameterization - a concise overview"		
German	C79000-M7300-C191	
English	C79000-M7376-C191	
French	C79000-M7377-C191	
Spanish	C79000-M7378-C191	
Italian	C79000-M7372-C191	
Transport housing		
- For AC 230 V version	7ND9500-8AA3	
- For DC 24 V version	7ND9500-8AA4	
SIMATIC PDM software from V5.2 onwards	See catalog FI 01	
for parameterization of SIREC L and SIREC LA line recorders, with documentation (as help file)		
Adapter cable for PC interface, with adapter (25 to 9)	C79453-A3070-B104	
Consumable material		
Chart paper 120 mm wide		
Recording width 100 mm		
50 linear graduations		
• Roll, approx. 31 m long, approx. 0.15 kg		
Hours imprint		
For 10 mm/h	C72452-A94-B208	
20 mm/h	C72452-A94-B209	
60 mm/h	C72452-A94-B210	
120 mm/h	C72452-A94-B211	
Without	C72452-A94-B212	
Price per roll	20	
when ordering	60	
	100	
• Fanfold, approx. 16 m long, approx. 0.1 kg		
Hours imprint		
For 10 mm/h	C72452-A94-B262	
20 mm/h	C72452-A94-B263	
60 mm/h	C72452-A94-B264	
120 mm/h	C72452-A94-B265	
Without	C72452-A94-B266	
Price per pack	20	
when ordering	60	
	100	

Ordering data	Order No.	Price
Chart paper 120 mm wide		
Recording width 100 mm		
Without graduations		
• Roll, approx. 31 m long, approx. 0.15 kg	7ND9000-8EE	
Price per roll	20	
when ordering	100	
• Fanfold, approx. 16 m long, approx. 0.1 kg	7ND9000-1AE	
Price per pack	20	
when ordering	100	
Fiber pen assembly		
Installation at top (channel 3)		
Green	7ND9001-8AG	
Installation in center (channel 2)		
Blue	7ND9001-8AD	
Red	7ND9001-8AE	
Installation at bottom (channel 1)		
Red	7ND9001-8AA	
Blue	7ND9001-8AB	
For alphanumeric output		
Black	7ND9001-8DH	
Lithium battery, 3 V (for the clock module)	W79084-L1002-B1	

Available ex stock

2

1) Observe range limits in the technical data.

2) Set to three-wire system.

3) To DIN IEC 584 To DIN IEC 584 To DIN 43710
 Type J: Fe/CuNi Type N: NiCrSi/NiSi Type L: Fe-CuNi
 Type K: NiCr/Ni Type E: NiCr/CuNi Type U: Cu-CuNi
 Type T: Cu/CuNi Type B: Pt30Rh/Pt6Rh
 Type S: Pt 10 % Rh/Pt Type R: Pt13Rh/Pt

4) Specify in addition: Order code(s) for the required recording range(s) including plain text(s) for the scale(s)

5) Also available by downloading from the Internet (see page 5/10 bottom).

Line and multipoint recorders

SIREC L/LA

Line recorder 144 x 144

Ordering data (continued)	Order No.	Price
Conversion parts		
Digital input/output		
Electronic outputs	7ND9400-8BF	
Relay outputs	7ND9400-8BE	
DC 24 V output	7ND9400-8BG	
Recording unit		
For rolls or fanfold paper	C72301-A20-A17	
Take-up spool with rubber tongues	C72301-A20-B110	
Housing door with lock		
Normal	C79165-A3029-B28	
Low-reflection	C79165-A3029-B30	
Mounting set 72 x 72 for installation in panel or desk upright panel with basic grid dimensions 72 x 72	C79453-A3011-D101	
Measuring-point label		
Without inscription	C79165-A3029-B367	
With inscription (max. 29 digits per channel), specify in plain text: Desired text:	C79165-A3029-B368-Z Y01	
Ruler		
Without scale	7ND9262	
With one scale, Order code Y . . (see page 2/15)	7ND9272-Z Y . .	
Dummy pen required for channel not equipped with a pen assembly	C79453-A3049-B522	
Scales (see Fig. 2/7)		
• Without graduations (start and end are marked)	7ND9300-8RA	
• 1 scale for single-channel recorder (1 scale each for graduations, measured variable and dimension)	7ND9300-8RB	
• 1 scale for dual- and three- channel recorders (one scale is required for each channel)	7ND9300-8RC	

2

Line and multipoint recorders

SIREC P/PA

Multipoint recorder 144 x 144

Microprocessor-based
multipoint recorder 144 x 144
Six-channel recorder, class 0.5
With fiber pen recording
Input variables DC U/I/TC/RTD/R
With or without text output



Fig. 2/9 SIREC P/PA (with alphanumeric text output)

2

Features

General:

- Operating modes:
 - Measure, display, record
- Pen lift with pauses in operation and also in event of power failure
- Pens easily replaceable from the front
- Limit monitoring:
 - Alarm identification and output with limit violations, freely-adjustable for every channel
- Time marking
- Input/output module: 4 inputs, 6 outputs electrically isolated; electronic outputs or relays
- Floating DC 24 V output for supply of input/output module or transmitter
- CE symbol, NAMUR and KTA requirements complied with; permits use under all conditions
- Housing front with degree of protection IP 54
- Installation without interspacing possible
- Mounting depth including connections 260 mm

In addition for recorders with alphanumeric text output

- Real-time calendar/clock
- Summer time/winter time switchover
- Output of error messages, instrument text

Measure:

- 6 analog channels and 2 digital channels
- Channel isolation: semiconductor relays, floating
- Measuring cycle 640/400 ms
- Measured variables (free selection possible):
 - Direct current, DC voltage
 - Temperature via thermocouple or resistance thermometer
 - Resistance transmitter (two-wire or three-wire system)
 - 2 digital channels
- Measuring ranges freely selectable with the range limits
- High measuring accuracy

Display:

- One scale plate (with max. 4 scales) and one pointer for measured values, easy readability
- LED status display (NAMUR)

Record:

- Recording with fiber recording head, 6 colors
- Freely-programmable recording ranges
- Adjustable chart speed
- Curve display (dotted line or dot-joining selectable)
- Zooming (scale expansion)
- Event marking
- Chart paper: roll or fanfold
- Formamide-free ink, large reservoir

In addition for recorders with alphanumeric text output

- Chart paper: also grid-free chart, grid is generated (in 8 steps)
- Alphanumeric output:
 - date, time, start/stop line, channel code, alarms, 6 event texts (with 16 characters each), measured-value table and parameter printout

Adjustment/operation:

- All adjustments and operations using levers at front and via the PC interface (SIMATIC PDM software)
- Settings are saved by the non-volatile memory (EEPROM)

Technical data

Note: Only values with tolerances or limits are guaranteed data. Values without tolerances are informative data. The defined error limits apply following a warming-up time of 30 minutes.

Measuring functions

General data

Number of channels	analog digital	6 2 (see digital input/output)
Channel isolation		Electrically isolated via semiconductors
Voltage endurance		See Table "Interference rejection" (page 2/20), protected with varistors from protective earth conductor

Line and multipoint recorders SIREC P/PA

Multipoint recorder 144 x 144

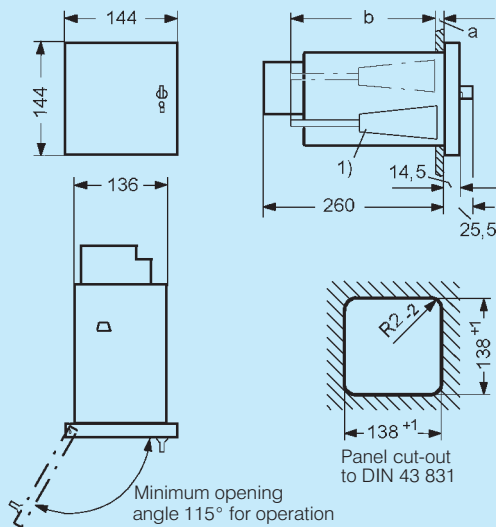

Distance between centers
of 2 adjacent instruments or one above the other: ≥ 144 mm

Installation in	a	b
Sheet-steel panel or sheet-steel desk upright panel	2 to 42	230
Panel or desk upright panel with basic grid dimension 72 x 72	39 to 81	195.5

1) The clamps can also be fitted at the top and bottom.

Fig. 2/10 Dimensions

Permissible potential	Max. DC 24 V compared to PE conductor; only measuring circuits with safe isolation from power supply are permissible
Input overload	Max. 10 % of full-scale value
Overload	Max. 24 V continuously in DC U range, max. 40 mA continuously in DC I range
A/D conversion	Dual-slope converter
Resolution	14 1/2 bits
Common-mode rejection	90 dB at 50 Hz
Series-mode rejection	60 dB at 50 Hz
Reference conditions	
Ambient temperature	23 ± 2 °C
Relative humidity	55 ± 10 %
Source resistance	≤ 1 k Ω
Potential difference	≤ 1 V
Adjustment interval	≤ 24 months; an additional error of 0.01 %/year must be expected with a longer interval
Measured value calibration	Class 0.5 to DIN 43 782 or IEC 484
Damping	1st order low-pass, 0, 1, 3, 10, 30, 100 s or automatic adaptation to chart speed

Note:

A special calibration from a service place is recommended for a large stretching of the measuring ranges.

1) The specified values apply to the normal measuring cycle, they must be doubled for the fast cycle; the offset error F_{offset} becomes approx. 30 % larger.

2) Measuring error

F_{offset} (zero error) = absolute value specified in table
 F_{rel} (increasing error) = percentage specified in table multiplied by the value of the read measured value (% · |MV|)
 F_{temp} (temperature error at an increased ambient temperature) =

Measuring range/ linearization range ³⁾	Reso- lution Normal cycle ¹⁾	Maximum electric measuring error ²⁾			
		F_{offset}	F_{rel}	F_{temp}	F_{term}
-40 to +40 mV	4 μ V	16 μ V	0.05	0.02 + 0 mV	-
-100 to +100 mV	10 μ V	30 μ V	0.05	0.02 + 0 mV	-
-400 to +400 mV	40 μ V	120 μ V	0.05	0.02 + 0 mV	-
-1000 to +1000 mV	100 μ V	300 μ A	0.05	0.02 + 0 mV	-
-1 to +1 V	0.1 mV	0.3 mV	0.05	0.02 + 0 mV	-
0 to +1 V	0.1 mV	0.3 mV	0.05	0.02 + 0 mV	-
+0.2 to +1 V	0.1 mV	0.3 mV	0.05	0.02 + 0 mV	-
-10 to +10 V	1 mV	3 mV	0.05	0.02 + 0 mV	-
0 to +10 V	1 mV	3 mV	0.05	0.02 + 0 mV	-
+2 to +10 V	1 mV	3 mV	0.05	0.02 + 0 mV	-
-20 to +20 mA	2 μ A	6 μ A	0.05	0.02 + 0 mA	-
0 to +20 mA	2 μ A	6 μ A	0.05	0.02 + 0 mA	-
+4 to +20 mA	2 μ A	6 μ A	0.05	0.02 + 0 mA	-
J (Fe/CuNi) -100 to +1200 °C/ -210 to +1200 °C	0.2 °C	0.6 °C	0.06	0.02 + 0 °C	0.8 °C
K (NiCr/Ni) -100 to +1370 °C/ -270 to +1370 °C	0.3 °C	0.8 °C	0.06	0.02 + 0 °C	0.8 °C
R (Pt13Rh/Pt) +100 to +1760 °C/ -50 to +1760 °C	0.5 °C	1.8 °C	0	0.01 + 0.2 °C	0.6 °C
T (Cu/CuNi) -100 to +400 °C/ -270 to +400 °C	0.2 °C	0.6 °C	0.07	0.02 + 0 °C	0.8 °C
S (Pt10Rh/Pt) +100 to +1760 °C/ -50 to +1760 °C	0.5 °C	1.8 °C	0	0.01 + 0.2 °C	0.6 °C
N (NiCrSi/NiSi) -100 to +1300 °C/ -200 to +1300 °C	0.4 °C	1 °C	0.05	0.02 + 0 °C	0.8 °C
E (NiCr/CuNi) -100 to +1000 °C/ -270 to +1000 °C	0.15 °C	0.5 °C	0.06	0.02 + 0 °C	0.8 °C
B (Pt30Rh/Pt6Rh) +600 to +1820 °C/ +100 to +1820 °C	0.6 °C	2 °C	0	0.01 + 0.2 °C	0.4 °C
L (FeCu/Ni) -100 to +900 °C/ -200 to +900 °C	0.2 °C	0.6 °C	0.06	0.02 + 0 °C	0.8 °C
U (Cu/CuNi) -100 to +560 °C/ -200 to +560 °C	0.2 °C	0.6 °C	0.07	0.02 + 0 °C	0.8 °C
0 to 300 Ω	0.03 Ω	0.2 Ω	0.07	0.02 + 0.02 Ω	-
0 to 1000 Ω	0.1 Ω	0.5 Ω	0.07	0.02 + 0.04 Ω	-
Pt 100 -200 to +800 °C/ -200 to +800 °C	0.08 °C	0.5 °C	0.05	0.02+0.05 °C	-
Ni 100 -60 to +180 °C/ -60 to +180 °C	0.05 °C	0.25 °C	0.07	0.02+0.025°C	-

percentage specified in table multiplied by the value of the absolute measured value (% · |MV|) plus a constant specified as an absolute value, total multiplied by the value of the temperature difference between the reference value 23 ± 2 °C and the ambient temperature.
 F_{terminal} (error of terminal temperature measurement) = absolute value specified in table for additional error with direct connection of thermocouples.

3) Linearization range = measuring range with thermocouples with slightly increased error at start-of-scale including overload range.

Line and multipoint recorders

SIREC P/PA

Multipoint recorder 144 x 144

Input resistance	10 M Ω in the TC/DC U range at \leq 100 mV; 100 k Ω in the DC U range at 1 and 10 V; 50 Ω in the DC I range
Measuring mode	
Measuring cycle, adjustable	Normal 640 ms, fast 400 ms
Measuring duration	40 ms (50 Hz), 33 1/3 ms (60 Hz)
Type of connection for resistance measurements	Two-wire or three-wire system
Signal connection (see Fig. 2/11)	
Terminal range	2 or 3 screw terminals per channel 0.13 to 2.5 mm ² solid conductor 0.13 to 1.5 mm ² stranded conductor with sleeves Terminal designations to DIN 45 140
Operation, displays	
Display	1 scale and 1 pointer for measured values, green LED for display of recorder readiness, red LED for display of programming and test status
Operation	2 levers for function settings, 2 levers for service (mechanical release)
PC interface	For all settings and measured-value scanning
Connection	2-pin plug at front, connection to PC via special cable (accessory)
Real-time clock (with alphanumeric text output)	
Format	Year, month, day, hour, minute, second; 12/24-hour representation, summer/winter time switchover
Deviation	Max. $1 \cdot 10^{-5}$
Backup	Via capacitor in event of power failure (approx. 5 min) or via battery (approx. 36 months)
Recording	
Operating modes	
Graphic recording	Dots or joined dots, programmable, time per dot programmable: 3, 6, 12, 24, 48 s or automatically adapted to selected chart speed
Alphanumeric printout (only recorders with alphanumeric text output)	Channel No., alarm symbols, date and time, measured-value table, 6 event texts (with 16 characters each), text with up to 20 characters; during pauses in operation: printout of measuring parameters
Recording range	"Value left" and "Value right" freely programmable
Recording system	
Pen assembly	Replaceable fiber pens
Colors	Violet, red, black, green, blue, brown
Recording length	Approx. 1800 m/color
Service period	Approx. 6 months
Storage life	Approx. 24 months in closed packing Approx. 1 month in recorder with climate to DIN IEC 654-1

Pen assembly drive	Program-controlled step motor
Resolution	0.125 mm
Carriage speed	Max. 125 mm/s
Recording system error	$F_{\text{mech}} \leq 0.3 \%$
Chart drive	Program-controlled step motor class 0.005 DIN 43 782
Step length	0.02 mm
Chart speeds	
A and B (v1/v2) programmable	0 - 1 - 1.25 - 2.5 - 5 mm/h 10 - 20 - 60 - 120 mm/h (v1/v2 selectable via binary signal)
Chart paper	
Chart width	120 mm
Recording width	100 mm
Alphanumeric recording	
Character height	Approx. 2.2 mm
Characters/line	53
Character set	ASCII standard with upper-case and lower-case letters, Greek alphabet and special characters in 6 colors
Measured-value damping	
Filter	1st order low-pass
Time constant	0, 1, 3, 10, 30, 100 s per channel Adjustable or automatic adaptation to chart speed
Limit monitoring	6 alarms, free assignment of channels MIN or MAX can be set
Alarm output	Recording of a symbol in event of upward or downward violation of a limit
Limit hysteresis	2 % of recording range
Digital input/output	
Digital inputs	4, electrically isolated via opto isolators, passive
Switching level	Low: -3 to +5 V, High: +8 to +30 V
Signal duration	≥ 0.5 s
Input resistance	≥ 5 k Ω
Functions	2 digital channels, measuring mode "Normal/Fast" each with "On/Off", chart speeds A/B, chart feed 10 to 100 mm, clock synchronization, summer time/winter time, input interlocking, event text, measured-value tables
Digital outputs	6
Electronic version	Electrically isolated via opto isolators, semiconductor switches, short-circuit-proof, open collector, P-switching Max. 150 mA High ext. voltage ≥ -2 V DC 18 to 30 V
Relay version	Electrically isolated via relays, floating switchover contacts 50 V, 1 A (external voltage) 30 W or 60 VA 1 x 10 ⁸ mechanical 3 x 10 ⁶ at max. load
Switching voltage/current	50 V
Switching capacity	50 V
Contact life	Subminiature plug, 25-pin, lockable
Permissible potential	
Connections	

Line and multipoint recorders SIREC P/PA

Multipoint recorder 144 x 144

Power supply	
AC power supply	
Mains voltage	AC 230/115 V +15 to -20 % AC 24 V +15 to -20 %
Frequency range	47 to 64 Hz
Power consumption	20 VA (with options) at rated voltage
DC power supply	
Rated voltage	DC 24 V +20 to -15 %
Power consumption	15 W (with options) at rated voltage
DC 24 V output	DC 24 V ± 15 %, 75 mA, short-circuit-proof Capacitive load ≤ 33 µF
Ambient conditions	
Climate	To IEC 68/2-1/2/ DIN EN 60 068-2-1/2
Temperature of use	0 to 50 °C (max. 75 % rel. humidity at 25 °C, no condensation), change in temp. max. 10 K/h
Storage temperature range	-25 to +70 °C (max. 75 % rel. humidity at 25 °C, no condensation), change in temperature max. 20 K/h
Mechanical	
Vibrations during operation	To DIN IEC 68-2-6 5 to 9 Hz; 3.5 mm deflection 9 to 200 Hz; 10 m/s ² acceleration
Vibrations during storage and transport	To DIN IEC 68-2-6 5 to 9 Hz; 3.5 mm deflection 9 to 500 Hz; 10 m/s ² acceleration
Drop test for packed unit	To DIN EN 60 068-2-32, height < 0.8 m
Shock test during operation	To IEC 68-2-27/ DIN EN 60 068-2-27 Half-sine: 150 m/s ² (15 g), 11 ms Parameters to KWU AVS DD 7080.9; 5 to 35 Hz; max. 10 mm deflection, max. 15 m/s ² acceleration
Resistance to earthquakes during operation	
Mounting position	
Operation with roll	To DIN 16 257 Vertical -30 to +15°
Operation with fanfold	Vertical -15 to +15°
Degree of protection	
Front with door	To IEC 529 or EN 60 529 IP 54
Terminals, interfaces, plug connectors	IP 20
Electric safety	
According to low-voltage guideline 73/23/EEC to EN 61010-1, overvoltage category II, degree of contamination 2 (IEC 1010-1, VDE 0411 Part 1)	
Protection class	I

Electromagnetic compatibility				
Emitted interference				
The targets of the EMC guideline 89/336/EEC with respect to radio interference suppression to EN 50 081-1 and interference rejection to EN 50 082-2, as well as NAMUR recommendation NE 21 are observed.				
Radio interference		Limit class B, measured according to VDE 0875 Part 11 (CISPR 11)		
Power supply				
Interference rejection				
Device-under-test	Influencing variable	Basic standard	Instrument	
			Test condition	Res ²⁾
Instrument	RF field AM	IEC 1000-4-3	10 V/m ¹⁾	A
	RF field PM	IEC 1000-4-3	10 V/m	A
	Mag. field	IEC 1000-4-8	³⁾	-
	Discharge	IEC 1000-4-2	6/8 kV	A
Process, measuring and control lines	RF conducted interference	IEC 1000-4-6	10 V	A
	Burst	IEC 1000-4-4	2 kV	A
	Surge	IEC 1000-4-5I	1/2 kV ⁴⁾	B
DC power inputs	RF conducted interference	IEC 1000-4-6	10 V	A
	Burst	IEC 1000-4-4	2 kV	A
	Surge	IEC 1000-4-5	1/2 kV ⁴⁾	A
	Interruption	IEC SC77BWG3	20 ms/100 %	A
	In-rush current	-	≤ 15 I _{rated}	-
AC power inputs	RF conducted interference	IEC 1000-4-6	10 V	A
	Burst	IEC 1000-4-4	2 kV	A
	Surge	IEC 1000-4-5	1/2 kV ⁴⁾	A
	Interruption	IEC SC77BWG3	20 ms/100 %	A
	In-rush current	IEC 1000-3-3	≤ 15 I _{rated}	-
	Overshoots	IEC 1000-3-2	Class D	-
Earth connection	RF conducted interference	IEC 1000-4-6	10 V	A
Dimensions, mounting				
Dimensions		Front dimensions 144 x 144 to DIN 43 700 and DIN 43 831 (see Fig. 2/10)		
Mounting				
Panel mounting		To DIN 43 834-A-340		
Desk and cabinet mounting		To DIN 43 834-A-330		
Front door		Plastic, spring-loaded latch		
Weight		Approx. 4 kg		

¹⁾ 3 V/m in the ranges 87 to 108, 174 to 230 and 470 to 790 MHz

²⁾ Response A = class accuracy retained during effect

Response B = interference possible during effect

- = not relevant

³⁾ Not relevant because of measuring and recording procedure used

⁴⁾ 1 kV symmetric, 2 kV asymmetric

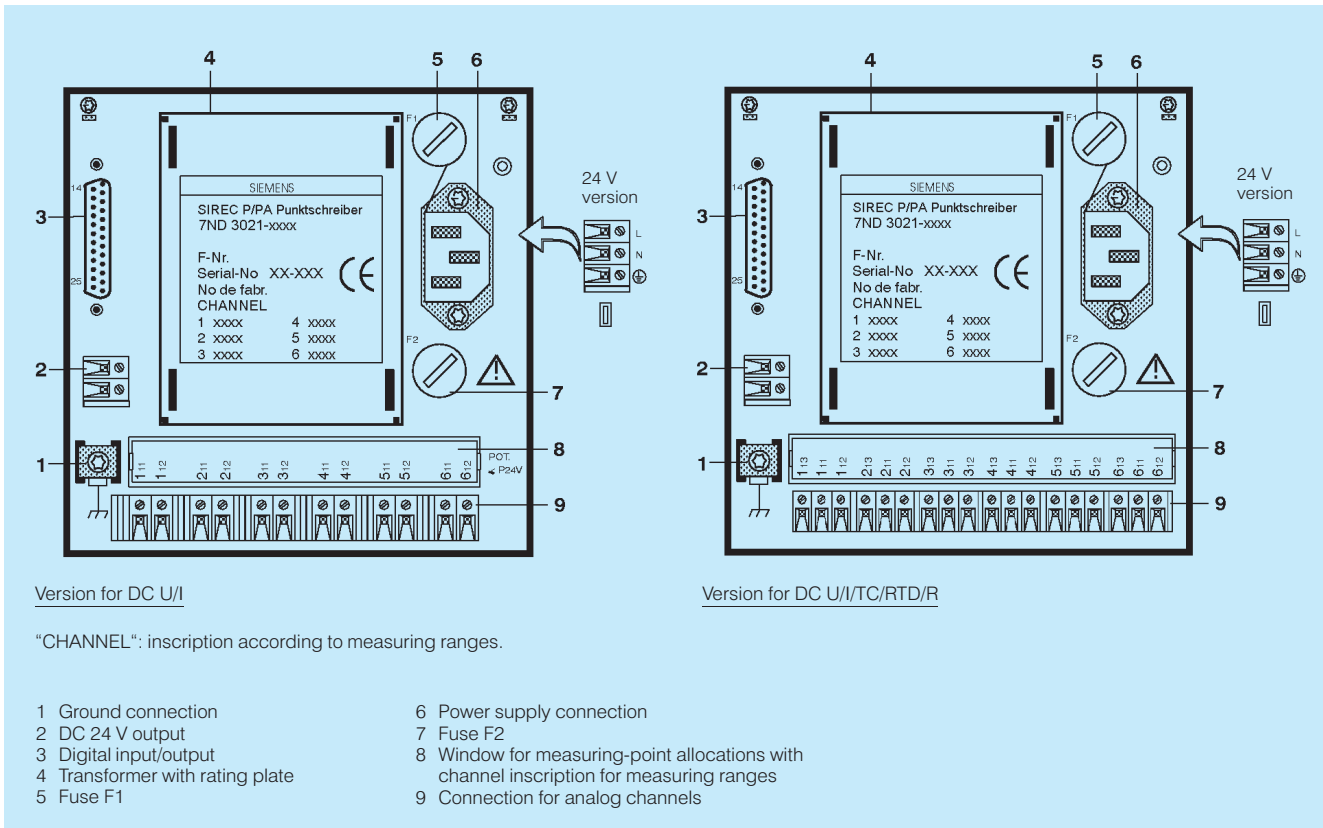

2

Fig. 2/11 Connection diagrams

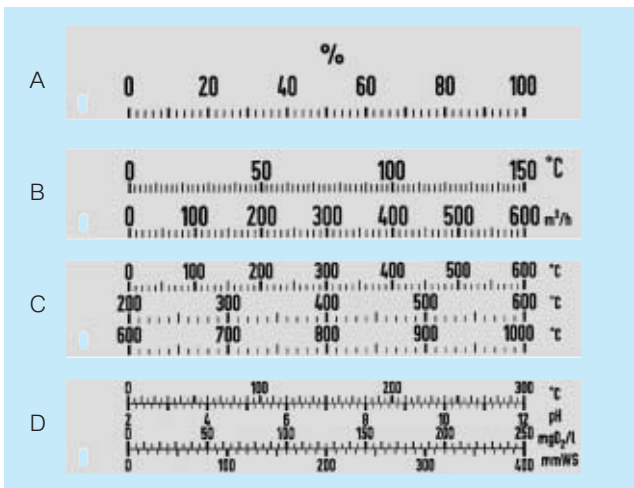

Fig. 2/12 Scale versions

Line and multipoint recorders

SIREC P/PA

Multipoint recorder 144 x 144

Ordering data		Order No.	Order code	Price
SIREC P/PA Six-channel multipoint recorder ¹⁾ , front dimensions 144 mm x 144 mm, with recording unit for rolls or fanfold paper		7ND3021-		
<u>Power supply</u>	AC 47 to 64 Hz 220 to 240 V AC 47 to 64 Hz 110 to 127 V AC 47 to 64 Hz 24 V DC 24 V	1 2 3 4		
<u>Alphanumeric text</u>	With Without	A B		
<u>Measured variables</u>	DC U/I DC U/I/TC/RTD/R DC U/I, with DC 24 V output DC U/I/TC/RTD/R, with DC 24 V output	A B C D		
<u>Digital input/output</u>	Without With digital input, electronic output With digital input, relay output	1 2 3		
<u>Installation</u>	In sheet-steel panel, cabinet or sheet-steel desk upright panel, with 2 clamps C72165-A405-B176 In panel or desk upright panel with basic grid dimension 72 x 72, with one set of mounting parts C79453-A3011-D101	1 3		
<u>Instrument settings</u>	Recording range Scale(s) (max. 4) ³⁾ 4 to 20 mA 0 to 100 % (for all channels) According to plain text According to plain text	1 4 ²⁾	-Z ...	
<u>Housing door in protection IP 54</u>	Without lock Standard door Door with low-reflection glass With lock Standard door Door with low-reflection glass	N P R S A		
<u>Measuring-point label</u>	Unlabelled Labelled (max. 29 digits/channel); specify desired inscription in plain text:	1 9	R1Y	

Further designs on request.

Available ex stock

Accessories, consumable material and conversion parts on page 2/23

Scope of delivery

SIREC P/PA multipoint recorder as ordered, 1 ruler per scale, 1 measuring-point label, 2 blank labels (for inscription of signal input), 2 clamps or 1 set of mounting parts, 2 instrument fuses, appliance plug, 1 roll of chart paper, 1 pen, 1 battery (fitted in 7ND3021-.A...-...), installation instructions, instructions "Operation - a concise overview", instructions "Parameterization - a concise overview", 2 keys for housing door with lock, 1 plug connector for recorder with digital input/output and for recorder with alphanumeric text, 6 shorting jumpers.

When using several SIREC P/PA recorders it is sometimes only necessary to have one Manual. This is therefore not included in the delivery and must be ordered separately.

¹⁾ Basic setting on delivery:

- The program interlock in the test menu is set such that only chart speed A (set to 20 mm/h) can be changed using the lever (enabling of lever is possible at any time).
- Dot joining for the graphic display of measured values.
- Color selected for output text: violet
- Channels with "Channel-specific parameters" are set to Measure ON and Recording ON. Channels without "Channel-specific parameters" are set to Measure OFF
- Noise suppression set for AC 50 Hz (switchable to AC 60 Hz).

²⁾ Plain text is required for each channel (sequence: channel 1 to 6) for the recording range and scale (max. 4 different scales are possible for the 6 channels).

Example: SIREC P/PA multipoint recorder, power supply AC 220 to 240 V, with text output, measured variables: DC U/I/TC/RTD, with digital input/output via opto isolator, for installation in panel, standard door without lock, measuring-point label inscribed.

Channel	Recording range	Scale	Label inscription
1	4 to 20 mA	0 to 10 bar, linear	Blower 1
2	0 to 20 mA	0 to 10 bar, linear	Blower 2
3	2 to 10 V	0 to 400 °C, linear	Furnace 1
4	Thermocouple J	400 to 800 °C, linear	Furnace 2
5	Thermocouple K	400 to 800 °C, linear	Furnace 3
6	Pt 100 (3-wire system)	0 to 200 °C, linear	Stack

Order as follows:

7ND3021-1AB21-4NA9-Z
R1Y + Y02 + Y01 + Y08 + Y10 + Y14 + Y18
Plus all data from the table of the example.

³⁾ All scales with the dimension °C are temperature-linear. Voltage- or resistance-linear temperature scales (only for older non-linearizing temperature transmitters) are available according to data in plain text.

Line and multipoint recorders

SIREC P/PA

Multipoint recorder 144 x 144

Order codes																				Price		
Recording range	Measured variables								Direct connection of sensor										Acc. to plain text ¹⁾			
	DC I (mA)				DC U (V)				Type of TC ³⁾											RTD		
	0 to 20	4 to 20	0 to 1	0 to 10	0 to 1	0 to 10	0,2 to 1	2 to 10	J	L	T	U	K	N	E	S	B	R		Pt 100 ²⁾	Ni 100 ²⁾	
According to plain text	Y01	Y02	Y03	Y04	Y05	Y06	Y07	Y08	Y10	Y11	Y12	Y13	Y14	Y15	Y16	Y17	Y21	Y22	Y18	Y19	Y20	

Ordering data	Order No.	Price
Accessories		
Manual ⁸⁾		
German	C79000-G7300-C188	
English	C79000-G7376-C188	
French	C79000-G7377-C188	
Spanish	C79000-G7378-C188	
Italian	C79000-G7372-C188	
Installation Instructions ⁸⁾	C79000-M7364-C193	
Instructions		
"Operation - a concise overview"		
German	C79000-M7300-C192	
English	C79000-M7376-C192	
French	C79000-M7377-C192	
Spanish	C79000-M7378-C192	
Italian	C79000-M7372-C192	
Instructions		
"Parameterization - a concise overview"		
German	C79000-M7300-C191	
English	C79000-M7376-C191	
French	C79000-M7377-C191	
Spanish	C79000-M7378-C191	
Italian	C79000-M7372-C191	
Transport housing		
- For AC 230 V version	7ND9500-8AA3	
- For DC 24 V version	7ND9500-8AA4	
SIMATIC PDM software from V5.2 onwards	See catalog FI 01	
for parameterization of SIREC P and SIREC PA multipoint recorders, with documentation (as help file)		
Adapter cable for PC interface, with adapter (25 to 9)	C79453-A3070-B104	
Consumable material		
Chart paper 120 mm wide		
Recording width 100 mm		
50 linear graduations		
• Roll, approx. 31 m long, approx. 0.15 kg		
Hours imprint		
For 10 mm/h	C72452-A94-B208	
20 mm/h	C72452-A94-B209	
60 mm/h	C72452-A94-B210	
120 mm/h	C72452-A94-B211	
Without	C72452-A94-B212	
Price per roll	20	
when ordering	60	
	100	
• Fanfold, approx. 16 m long, approx. 0.1 kg		
Hours imprint		
For 10 mm/h	C72452-A94-B262	
20 mm/h	C72452-A94-B263	
60 mm/h	C72452-A94-B264	
120 mm/h	C72452-A94-B265	
Without	C72452-A94-B266	
Price per pack	20	
when ordering	60	
	100	

Ordering data	Order No.	Price
Consumable material		
(continued)		
Recording head (6 colors) violet, red, black, green, blue and brown	7ND9001-8FB	
Lithium battery , 3 V (for the clock module)	W79084-L1002-B1	
Conversion parts		
Digital input/output		
Electronic outputs	7ND9400-8BF	
Relay outputs	7ND9400-8BE	
DC 24 V output	7ND9400-8BG	
Recording unit		
For rolls or fanfold paper	C72301-A20-A17	
Take-up spool with rubber tongues	C72301-A20-B110	
Measuring-point label		
Without inscription	C79165-A3029-B12	
With inscription (max. 27 digits per channel), specify in plain text:	C79165-A3029-B12-Z	
Desired text: . . .	Y01	
Scales		
Type and arrangement of scales (Fig. 2/12)	Number of scales	
-	None ⁷⁾	7ND9300-8QA
A	One	7ND9300-8QB ^{5) 6)}
B	Two	7ND9300-8QC ^{5) 6)}
C	Three	7ND9300-8QD ^{5) 6)}
D	Four	7ND9300-8QE ^{5) 6)}
Ruler		
Without scale		7ND9262
With one scale		7ND9272 ⁶⁾

Available ex stock

- 1) Observe range limits in the technical data.
- 2) Set to three-wire system.
- 3) To DIN IEC 584
 Type J: Fe/CuNi To DIN IEC 584 Type N: NiCrSi/NiSi To DIN 43710
 Type K: NiCr/Ni Type E: NiCr/CuNi Type L: Fe-CuNi
 Type T: Cu/CuNi Type B: Pt30Rh/Pt6Rh Type U: Cu-CuNi
 Type S: Pt 10 % Rh/Pt Type R: Pt13Rh/Pt
- 4) Specify in addition: Order code(s) for the required recording range(s) including plain text(s) for the scale(s)
- 5) A scale plate with one, two, three or four scales is required per recorder (Fig. 2/12: A, B, C or D); scale sequence from 1 at bottom to 4 at top according to sequence of Order codes 1 to 4.
- 6) Specify in addition: Order code(s) for the required recording range(s) including plain text(s) for the scale(s) (see example for ordering on page 2/22).
- 7) Start and end are marked.
- 8) Also available by downloading from the Internet (see page 5/10 bottom).

2

Line and multipoint recorders SIREC PU

Multipoint recorder 144 x 144

7ND3523

Microprocessor-based
multipoint recorder with display
Six-channel recorder, class 0.5
With fiber pen recording
Input variables DC U/I/TC

Features

General:

- Operating modes:
 - Measure
 - Display (as number and bar)
 - Record
- Limit monitoring:
 - Alarm identification and output with limit violations, freely-adjustable for every channel
- Alarm linking
- Mathematical functions (cannot be retrofitted)
 - Fundamental operations
 - Statistical functions
 - Integration
 - Counter input
- Real-time calendar/clock
- Summer time/winter time switchover
- Output of error messages
- Input/output module: 4 inputs, 6 outputs via electronic outputs or relays
- Floating DC 24 V output for supply of input/output module or transmitter
- Housing front with degree of protection IP 54
- Installation without interspacing possible
- Mounting depth including connections 260 mm
- CE symbol, NAMUR/KTA requirements complied with

Measure:

- 6 analog channels and 2 digital channels
- Measuring cycle 0.3/0.5 s, depends on number of channels
- Measured variables (free selection possible):
 - Direct current, DC voltage
 - Temperature via thermocouples
- Channel isolation: semiconductor relays, floating
- Measured-value memory, thus no losses when replacing chart or during output of table (mixed mode)

Display:

- Display with background illumination, high contrast, large reading angle, background selectable as bright/black, brightness and contrast adjustable
- Display output of two measured values: numeric, analog bar display, mixed, including dimension, limit signals, alarm signals

Record:

- Recording with fiber recording head, max. 6 colors
- Curve display and printout as table
- Dot-joining technique
- Alphanumeric output: date, time, start/stop line, channel code, message text, alarms, event text, scale printout and measured-value table

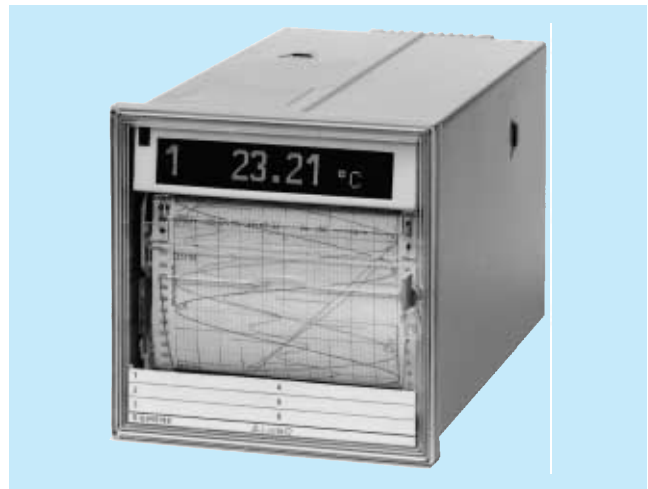

Fig. 2/13 SIREC PU

- Zooming and zoning (scale expansion and strip displays)
- Chart paper: roll or fanfold, also grid-free chart (grid is generated)

Adjustment/operation:

- Adjustments and operation using levers at front, the PC interface (SIMATIC PDM software) or the infrared remote control unit (is always required).
- Settings are saved by the non-volatile memory (EEPROM)

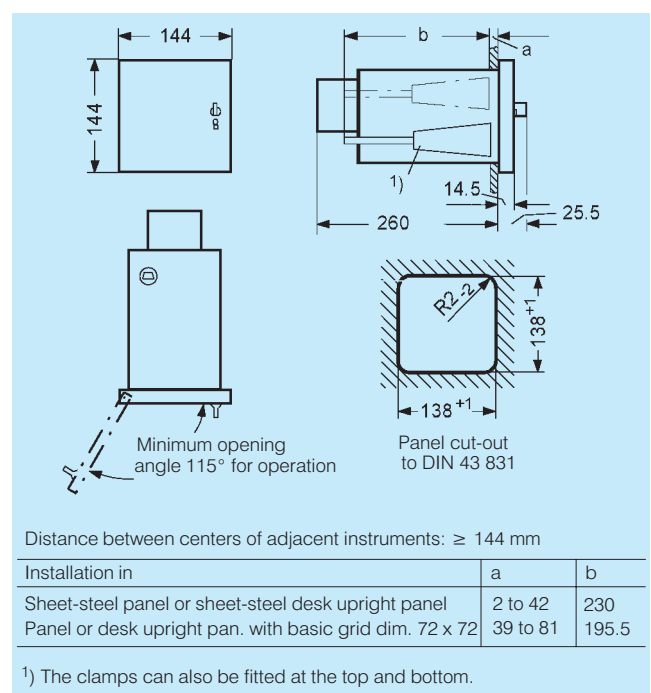

Fig. 2/14 Dimensions

Technical data					
<p>Note: Only values with tolerances or limits are guaranteed data. Values without tolerances are informative data. The defined error limits apply following a warming-up time of 30 minutes.</p>					
Measuring functions Number of channels Electric measuring ranges Thermocouples Functions $y = f(x)$		6 Adjustable In °C or K 6 freely-programmable assignments between the input variable (x) (signal range) and the output variable (y) (measuring range), e.g. linearization with a maximum of 50 turning points each Dimension: 5 characters/dimension, freely-selectable/function Logic operations e.g. for control purposes Electrically isolated via semiconductor relays Protected with varistors from PE conductor			
Channel isolation		Electrically isolated via semiconductor relays			
Voltage endurance		Protected with varistors from PE conductor			
Measuring range/linearization range ¹⁾	Resolution	Maximum electric measuring error ²⁾ $F_{el} = F_{offset} + F_{rel} + F_{temp} + F_{terminal}$ (typ. 1/5 of max. measuring error)			
		F_{offset}	F_{rel}	F_{temp}	F_{term}
-10 to +60 mV	4 µV	15 µV	0.02	0.015 + 0 mV	-
-0.1 to +1 V	60 µV	0.2 mV	0.02	0.015 + 0 mV	-
-1 to +10 V	0.6 mV	2 mV	0.02	0.015 + 0 mV	-
-4 to +20 mA	1.2 µA	5 µA	0.03	0.015 + 0 mA	-
J (Fe/CuNi) -100 to +1000 °C/ -210 to +1000 °C	0.1 °C	0.4 °C	0.04	0.015 + 0 °C	0.8 °C
K (NiCr/Ni) -100 to +1370 °C/ -270 to +1370 °C	0.1 °C	0.4 °C	0.04	0.015 + 0 °C	0.8 °C
R (Pt13Rh/Pt) 100 to +1760 °C/ -50 to +1760 °C	0.5 °C	1.8 °C	0	0.01 + 0.2 °C	0.6 °C
T (Cu/CuNi) -100 to +400 °C/ -270 to +400 °C	0.2 °C	0.6 °C	0.04	0.015 + 0 °C	0.8 °C
S (Pt10Rh/Pt) 100 to 1760 °C/ -50 to 1760 °C	0.5 °C	1.8 °C	0	0.01 + 0.2 °C	0.6 °C
N (NiCrSi/NiSi) -100 to +1300 °C/ -200 to +1300 °C	0.2 °C	0.8 °C	0.04	0.015 + 0 °C	0.8 °C
E (NiCr/CuNi) -100 to +800 °C/ -270 to +800 °C	0.1 °C	0.4 °C	0.04	0.015 + 0 °C	0.8 °C
B (Pt30Rh/Pt6Rh) 600 to 1820 °C/ 100 to 1820 °C	0.6 °C	2 °C	0	0.01 + 0.2 °C	0.4 °C
L (FeCu/Ni) -100 to +900 °C/ -200 to +900 °C	0.1 °C	0.4 °C	0.04	0.015 + 0 °C	0.8 °C
U (Cu/CuNi) -100 to +560 °C/ -200 to +560 °C	0.2 °C	0.6 °C	0.04	0.015 + 0 °C	0.8 °C

Note:

A special calibration from a service place is recommended for a large stretching of the measuring ranges.

1) Linearization range = measuring range with thermocouples with slightly increased error at start-of-scale including overload range.

2) Measuring error

F_{offset} (zero error) = absolute value specified in table

F_{rel} (increasing error) = percentage specified in table multiplied by the value of the read measured value (% · |MV|)

F_{temp} (temperature error at an increased ambient temperature) = percentage specified in table multiplied by the value of the absolute measured value (% · |MV|) plus a constant specified as an absolute value, total multiplied by the value of the temperature difference between the reference value 23 ± 2 °C and the ambient temperature.

$F_{terminal}$ (error of terminal temp. measurement = absolute value specified in table for additional error with direct connection of thermocouples.

Permissible potential	Max. DC 24 V compared to PE conductor; only measuring circuits with safe isolation from power supply are permissible
Detection of line breakage	60 mV range and TC, source resistance ≤ 2 k Ω
Input resistance	≥ 100 k Ω in DC U range 10 M Ω in TC range 50 Ω in DC I range
Overload capacity	Max. 10 % of respective electric start-of-scale or full-scale value
Overload	Max. 24 V continuously (in DC U/TC range) Max. 40 mA continuously (in DC I range)
A/D conversion	One common dual-slope converter
Measuring cycle	0.3 s with ≤ 3 channels, 0.5 s with ≥ 4 channels
Measuring duration	20 ms with 50 Hz mains freq. 16 2/3 ms with 60 Hz mains freq.
Resolution	14 1/2 bits
Common-mode rejection	≥ 90 dB for rated frequency
Series-mode rejection	≥ 60 dB for rated frequency
Reference conditions	
Ambient temperature	23 ± 2 °C
Relative humidity	55 ± 10 %
Source resistance	≤ 1 k Ω
Potential difference	≤ 1 V
Adjustment interval	≤ 12 months; an additional error of 0.01 %/year must be expected with a longer interval
Measured value calibration	Class 0.5 to DIN 43 782 or IEC 484
Damping	1st order low-pass, adjustable 0 to 120 s
Signal connection	2 screw terminals per channel
Terminal range	0.13 to 2.5 mm ² solid conductor 0.13 to 1.5 mm ² stranded conductor with sleeves Terminal designations to DIN 45 140
Mathematical functions	Addition, subtraction, multiplication, division, square-root, exponent, polynomial, Napierian log, common log, absolute value, minimum, maximum, mean value, equation editor, summation, F-value (sterilization), Digital counter inputs 2 Hz
Operation, displays	
Display	LCD with background illumination
Display modes	
Alphanumeric	Measured values, messages, settings
Bars	Measured values
Characters/line	16 or 11 (see Fig. 2/19)
Character height	6.5 or 13 mm (see Fig. 2/19)
Operation	4 levers for basic functions and servicing on recorder Infrared remote control unit for all setting data, menu-based PC interface on front, for all setting data and measured values
Real-time clock	
Format	Year, month, day, hour, minute, second; 12/24-hour representation, Summer/winter time switchover

Line and multipoint recorders

SIREC PU

Multipoint recorder 144 x 144

Error Backup	Max. $1 \cdot 10^{-5}$ Via capacitor in event of power failure (approx. 5 min) or via battery (approx. 36 months)
Recording	
Recording method	Discontinuous with intermediate storage of measured value, compensation of pen offset
Chart drive	Step motor
Chart speed (2 speeds preselectable and switchable via control input)	1 - 1.25 - 2 - 2.5 - 5 - 10 - 15 - 20 - 30 - 40 - 50 - 60 - 100 - 120 - 150 - 180 - 200 - 300 - 600 - 1200 mm/h
Recording system	
Pen assembly	Replaceable fiber pens
Colors	Violet, red, black, green, blue, brown
Recording length	Approx. 1800 m
Service period	Approx. 6 months
Storage life	Approx. 24 months in closed packing, approx. 1 month in recorder with climate to DIN IEC 654-1
Pen assembly drive	Program-controlled step motor
Resolution	0.125 mm
Carriage speed	Max. 125 mm/s
Recording system error	$F_{\text{mech}} \leq 0.3 \%$
Recording width	100 mm
Alphanumeric recording	
Character height	Approx. 2.2 mm
Characters/line	53
Character set	ASCII standard with upper-case and lower-case letters, Greek alphabet and special characters in 6 colors
Limit monitoring	
Alarm signalling	2 alarms per channel, free assignment of channels MIN or MAX adjustable
Limit hysteresis	Recording of a symbol in event of upward or downward violation of a limit
	2 % of recording range
Digital input/output	
Digital inputs	4, electrically isolated via opto isolators, passive
Switching level	Low ≤ 0.3 V, High +8 V to +30 V
Input resistance	≥ 5 k Ω
Digital outputs	6
Electronic version	Electrically isolated via opto isolators, semiconductor switches, short-circuit-proof, P-switching
Output current	Max. 150 mA
Switching level	High ext. voltage ≥ -2 V
Ext. power supply	DC 18 to 30 V
Relay version	Electrically isolated via relays, floating switchover contacts
Switching voltage/current	50 V, 1 A (external voltage)
Switching capacity	30 W or 60 VA
Contact life	1×10^8 mechanical 3×10^6 at max. load
Permissible potential	50 V
Connections	Subminiature plug, 25-pin, lockable

Power supply	
AC power supply	
Mains voltage	AC 230/115 V +15 % to -20 % AC 24 V +15 % to -20 %
Frequency range	47 to 64 Hz
Power consumption	30 VA (with options) at rated voltage
DC power supply	
Rated voltage	DC 24 V +20 % to -15 %
Power consumption	18 W (with options) at rated voltage
DC 24 V output	DC 24 V $\pm 15 \%$, 75 mA, short-circuit-proof Capacitive load ≤ 33 μ F
Ambient conditions	
Climate	To IEC 68-2-1/2/ DIN EN 60 068-2-1/2 0 to 50 °C (max. 75 % rel. humidity, no condensation), change in temperature max. 10 K/h
Temperature of use	
Storage temperature range	-25 to +70 °C (max. 75 % rel. humidity at 25 °C, no condensation), change in temperature max. 20 K/h
Mechanical	
Vibrations during operation	To DIN IEC 68-2-6 5 to 9 Hz; 3.5 mm deflection 9 to 200 Hz; 10 m/s ² acceleration
Vibrations during storage and transport	To DIN IEC 68-2-6 5 to 9 Hz; 3.5 mm deflection 9 to 500 Hz; 10 m/s ² acceleration
Drop test for packed unit	To DIN EN 60 068-2-32, height < 0.8 m
Shock test during operation	To IEC 68-2-27/ DIN EN 60 068-2-27 Half-sine: 150 m/s ² (15 g), 11 ms
Resistance to earthquakes during operation	Parameters to KWU AVS DD 7080.9; 5 to 35 Hz; max. 10 mm deflection, max. 15 m/s ² acceleration
Mounting position	
Operation with roll	To DIN 16 257 Vertical -30° to +15°
Operation with fanfold	Vertical -15° to +15°
Degree of protection	
Front with door	To IEC 529 or EN 60 529 IP 54
Terminals, interfaces, plug connectors	IP 20
Electric safety	
According to low-voltage guideline 73/23/EEC to EN 61010-1, overvoltage category II, degree of contamination 2 (IEC 1010-1, VDE 0411 Part 1)	
Protection class	I

Line and multipoint recorders

SIREC PU

Multipoint recorder 144 x 144

Electromagnetic compatibility Emitted interference The targets of the EMC guideline 89/336/EEC with respect to radio interference suppression to EN 50 081-1 and interference rejection to EN 50 082-2, as well as NAMUR recommendation NE 21 are observed. Radio interference Power supply <div style="border: 1px solid black; padding: 5px; display: inline-block;"> Limit class B, measured according to VDE 0875 Part 11 (CISPR 11) </div>				
Device-under-test	Influencing variable	Basic standard	Instrument	
			Test condition	Res ²⁾
Instrument	RF field AM RF field PM Mag. field Discharge	IEC 1000-4-3 IEC 1000-4-3 IEC 1000-4-8 IEC 1000-4-2	10 V/m ¹⁾ 10 V/m ³⁾ 6/8 kV	A A - A
Process, measuring and control lines	RF conducted interference	IEC 1000-4-6	10 V	A
	Burst	IEC 1000-4-4	1/2 kV	A
	Surge	IEC 1000-4-5I	1/2 kV ⁴⁾	B

- 1) 3 V/m in the ranges 87 to 108, 174 to 230 and 470 to 790 MHz
 2) Response A = class accuracy retained during effect
 Response B = interference possible during effect
 - = not relevant
 3) Not relevant because of measuring and recording procedure used
 4) 1 kV symmetric, 2 kV asymmetric

Device-under-test	Influencing variable	Basic standard	Instrument	
			Test condition	Res ²⁾
DC power inputs	RF conducted interference	IEC 1000-4-6	10 V	A
	Burst	IEC 1000-4-4	2 kV	A
	Surge	IEC 1000-4-5	1/2 kV ¹⁾	A
	Interruption	IEC SC77BWG3	20 ms/100 %	A
	In-rush current	-	≤ 15 I _{rated}	-
AC power inputs	RF conducted interference	IEC 1000-4-6	10 V	A
	Burst	IEC 1000-4-4	2 kV	A
	Surge	IEC 1000-4-5	1/2 kV ¹⁾	A
	Interruption	IEC SC77BWG3	20 ms/100 %	A
	In-rush current	IEC 1000-3-3	≤ 15 I _{rated}	-
	Overshoots	IEC 1000-3-2	Class D	-
Earth connection	RF conducted interference	IEC 1000-4-6	10 V	A

Dimensions, mounting

Dimensions

Front dimensions 144 x 144 to DIN 43 700 and DIN 43 831 (see Fig. 2/15)

Mounting

- Panel mounting
- Desk and cabinet mounting
- Front door

To DIN 43 834-A-340
 To DIN 43 834-A-330
 Plastic with spring-loaded latch

Weight

Approx. 4.3 kg

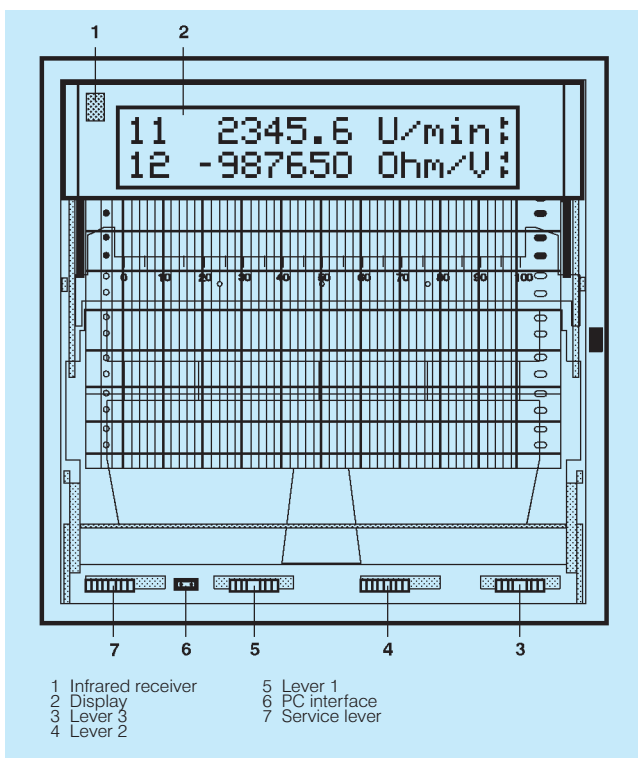

Fig. 2/15 Front view

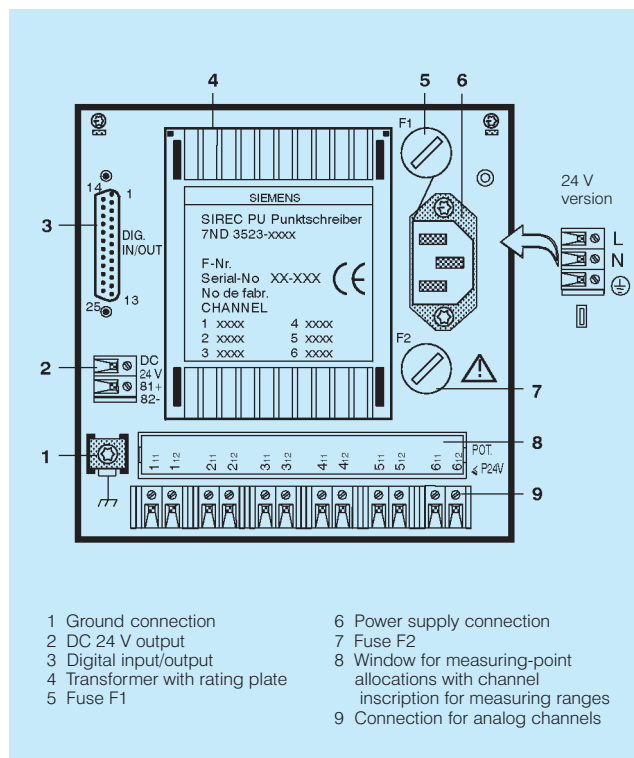

Fig. 2/16 Rear view

Line and multipoint recorders SIREC PU

Multipoint recorder 144 x 144

2

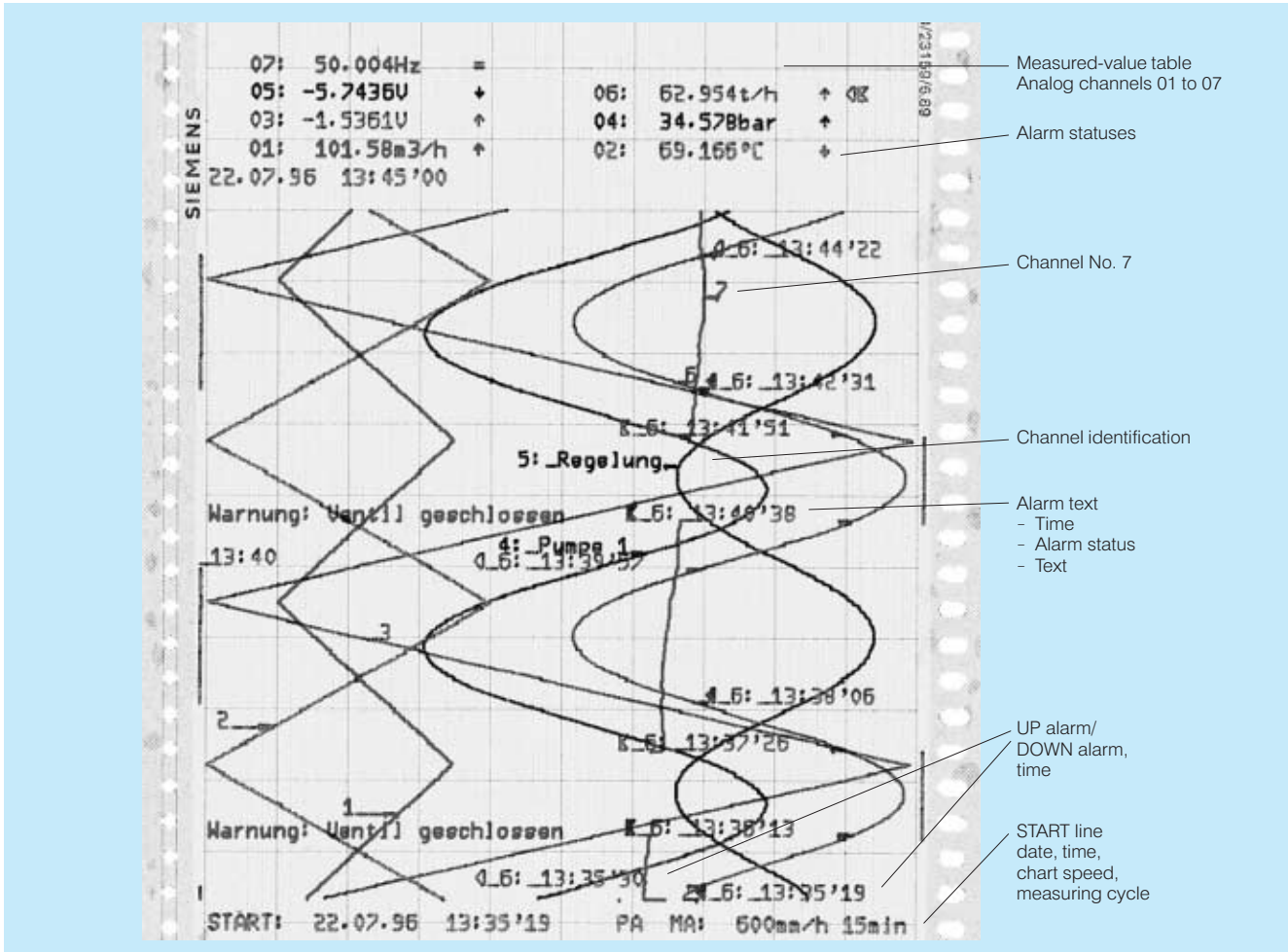

Fig. 2/17 Example of graphic recording (80 % of original size)

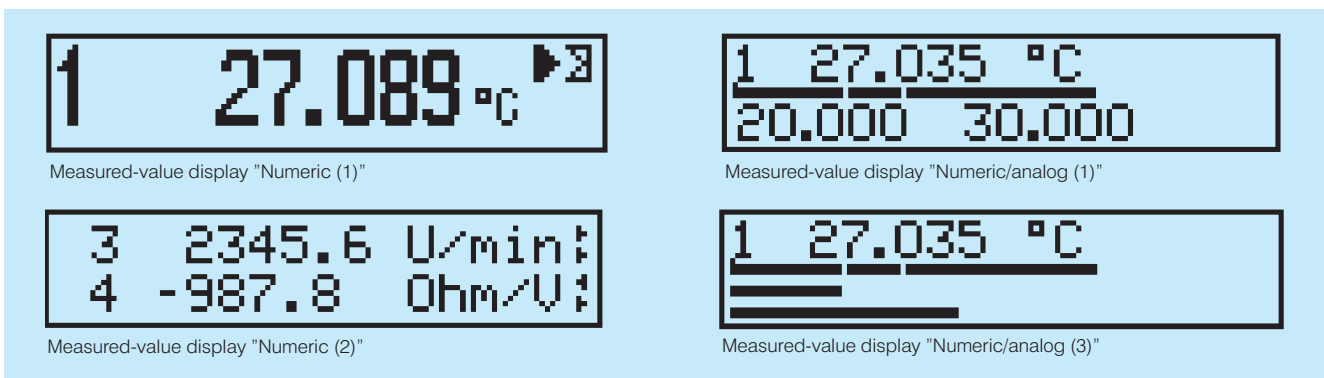

Fig. 2/18 Display examples

Line and multipoint recorders

SIREC PU

Multipoint recorder 144 x 144

Ordering data		Order No.	Order code	Price
<u>Recorders available ex stock</u> SIREC PU with display Six-channel multipoint recorder, front dimensions 144 mm x 144 mm For installation in sheet-steel panel, cabinet or desk upright panel With recording unit for rolls or fanfold paper		7ND3523- 1 A B 1 1 - 1 N A 1		
SIREC PU with display Six-channel multipoint recorder, front dimensions 144 mm x 144 mm For installation in sheet-steel panel, cabinet or desk upright panel With recording unit for rolls or fanfold paper				
<u>Power supply</u>	AC 47 to 64 Hz 220 to 240 V AC 47 to 64 Hz 110 to 127 V AC 47 to 64 Hz 24 V DC 24 V	1 2 3 4		
<u>Number of channels</u>	6 6, with mathematical functions ¹⁾	A B		
<u>Measured variables</u>	DC U/I/TC DC U/I/TC, with DC 24 V output	B D		
<u>Digital input/output</u>	Without With digital input, electronic output With digital input, relay output	1 2 3		
<u>Installation</u>	In sheet-steel panel, cabinet or sheet-steel desk upright panel, with 2 clamps C72165-A405-B176 In panel or desk upright panel with basic grid dimension 72 x 72, with one set of mounting parts C79453-A3011-D101	1 3		
<u>Recorder setting</u>	All 6 channels set to 4 to 20 mA Specify for all 6 channels in plain text (including built-in battery for clock module)	1 4		
<u>Measuring-point label</u>	Unlabelled Labelled (max. 29 digits/channel); specify desired inscription in plain text:		1 9	-Z Y01 R1Y

2

Further designs on request.

Note:
Operation always requires a remote control unit 7ND9190-8AA.

Accessories, consumable material and conversion parts on page 2/30

Scope of delivery

SIREC PU multipoint recorder 7ND3523 as ordered, 1 roll of chart paper, 1 accessories bag (1 recording head, 2 fuses), 1 appliance plug (with AC 230 or 115 V version), 2 clamps, 1 plug connector (with digital input/output), 1 measuring-point label, unpacking instructions, installation instructions, instructions "Operation - a concise overview", instructions "Parameterization - a concise overview", 1 battery (fitted).
 When using several SIREC PU recorders it is sometimes only necessary to have one Manual. This is therefore not included in the delivery and must be ordered separately.

¹⁾ SIPROM R-PU required for parameterization.

Line and multipoint recorders SIREC PU

Multipoint recorder 144 x 144

Ordering data	Order No.	Price
Accessories		
Manual (as file: Instruction Manual for recorder and PC interface) ¹⁾		
German	C79000-G7300-C195	
English	C79000-G7376-C195	
French	C79000-G7377-C195	
Spanish	C79000-G7378-C195	
Italian	C79000-G7372-C195	
Installation Instructions , in 5 languages	C79000-M7364-C200	
Instructions		
"Operation - a concise overview"		
German	C79000-M7300-C199	
English	C79000-M7376-C199	
French	C79000-M7377-C199	
Spanish	C79000-M7378-C199	
Italian	C79000-M7372-C199	
"Parameterization - a concise overview"		
German	C79000-M7300-C198	
English	C79000-M7376-C198	
French	C79000-M7377-C198	
Spanish	C79000-M7378-C198	
Italian	C79000-M7372-C198	
Transport housing		
- For AC 230 V version	7ND9500-8AA3	
- For DC 24 V version	7ND9500-8AA4	
SIMATIC PDM software from V5.2 onwards	See catalog FI 01	
for parameterization of SIREC PU multipoint recorders, with documentation (as help file)		
Adapter cable for PC interface, with adapter (25 to 9)	C79453-A3070-B104	
Infrared remote control unit with 4 alkaline batteries each 1.5 V	7ND9190-8AA	
Consumable material		
Chart paper 120 mm wide		
Recording width 100 mm		
50 linear graduations		
• Roll, approx. 31 m long, approx. 0.15 kg		
Hours imprint		
For 10 mm/h	C72452-A94-B208	
20 mm/h	C72452-A94-B209	
60 mm/h	C72452-A94-B210	
120 mm/h	C72452-A94-B211	
Without	C72452-A94-B212	
Price per roll	20	
when ordering	60	
	100	
• Fanfold, approx. 16 m long, approx. 0.1 kg		
Hours imprint		
For 10 mm/h	C72452-A94-B262	
20 mm/h	C72452-A94-B263	
60 mm/h	C72452-A94-B264	
120 mm/h	C72452-A94-B265	
Without	C72452-A94-B266	
Price per pack	20	
when ordering	60	
	100	

Order No.	Price
Chart paper 120 mm wide	
Recording width 100 mm	
Without graduations	
• Roll, approx. 31 m long, approx. 0.15 kg	7ND9000-8EE
Price per roll when ordering	20
	100
• Fanfold, approx. 16 m long, approx. 0.1 kg	7ND9000-1AE
Price per pack when ordering	20
	100
Recording head (6 colors) violet, red, black, green, blue and brown	7ND9001-8FB
Lithium battery , 3 V (for the clock module)	W79084-L1002-B1
Conversion parts	
Digital input/output	
Electronic outputs	7ND9400-8BF
Relay outputs	7ND9400-8BE
DC 24 V output	7ND9400-8BG
Recording unit	
For fanfold paper	C72301-A20-A6
For rolls or fanfold paper	C72301-A20-A7
Take-up spool with rubber tongues	C72301-A20-B110
Housing door with lock	
Normal	C79165-A3029-B28
Low-reflection	C79165-A3029-B30
Mounting set 72 x 72 for installation in panel or desk upright panel with basic grid dimensions 72 x 72	C79453-A3011-D101
Measuring-point label	
Without inscription	C79165-A3029-B382
With inscription (max. 29 digits per channel), specify in plain text:	C79165-A3029-B383-Z
Desired text:	Y01



Fig. 2/19 Infrared remote control unit

Available ex stock

¹⁾ Also available by downloading from the Internet (see page 5/10 bottom).

Hybrid recorders VARIOGRAPH



3/2	Summary
3/3	Technical explanations
3/6	Ordering information
3/7	VARIOGRAPH 7ND3521, 7ND3590, 7ND3560
3/7	Universal hybrid recorders 144 x 144, 288 x 144 and 288 x 288
3/16	Ordering data 144 x 144
3/17	Ordering data 288 x 144
3/18	Ordering data 288 x 288
3/19	Accessories
3/19	Consumable material
3/19	Replacement parts
3/19	Conversion parts

SIMATIC PDM software

for parameterizing of
VARIOGRAPH
see catalog FI 01

Hybrid recorders

Summary



3

	VARIOGRAPH 7ND3560 Page 3/7	VARIOGRAPH 7ND3590 Page 3/7	VARIOGRAPH 7ND3521 Page 3/7
Format Class	288 x 288	288 x 144 0.5	144 x 144
Microprocessor-based		■	
Analog inputs		3, 6 or 12	
Digital inputs/outputs		6/8	
Inputs		Plug-in modules	
Measured variable	Current Voltage	DC DC	
Temperature		Thermocouple Resistance thermometer	
Resistance		■ (2- or 3-wire)	
Measuring ranges		Freely-programmable	
Operating modes		Display, curves, tables	
Recording method		Fiber pen	
Chart paper	Roll	Roll	Roll or fanfold pack
Recording width	210 mm	210 mm	100 mm
Number of colors		6	
Text printout		■	
Scale printout		■	
Date and time printout		■	
Alarms		2 per channel, freely-programmable	
Math. functions		■	
Alarm text		Per channel	
Alarm linking		■	
Zooming		■	
Zoning		■	
Remote operation		■	
Remote control		-	
PC connection		■	
Line recorder function		Dot-joining	
Pen offset		Compensated	
Interface		Serial	
Storage (measured values)		Short-term	
Power supply		AC 24 or 110 to 240 V DC 24 or 110 to 230 V	
Operator prompting		De/En/Fr	
Mounting		Sheet-steel panel, desk upright panel, cabinet	
Installation without interspacing		Panel with 72 x 72 grid ■	

The range of flush-mounted recorders – 3 standardized formats – comprises 3 **hybrid recorders** which can record texts and the date and time in addition to printing curves and tables of measured values.

Fiber pens are used for recording. All recorders are characterized by a robust design and programmable parameters. The recording is largely independent of the position, and the recorders are easy to service.

Recording method

With the **fiber pen recording**, the reservoir and fiber tip are combined in one assembly. Violet, red, black, green, blue and brown pens are available for the VARIOGRAPH hybrid recorders.

VARIOGRAPH recording method

The VARIOGRAPH recorders operate according to a discontinuous recording method.

The values are measured using a short scanning cycle, stored in intermediate memory, and output channel-by-channel within one recording cycle with a max. recording length of 5 mm.

If

- highly oscillating signals with a large amplitude (approx. $\frac{2}{3}$ of the chart width) and/or
- long character strings such as texts and measured-value tables

have to be output over a longer period, the maximum possible output speed of the recording system is insufficient.

To prevent the loss of measured values with such types of signal – which are not typical for process engineering applications – the maximum chart speed should not be set. It is additionally recommendable to omit simultaneous use of all properties of the recorders in such cases, especially the output of texts and tables.

Design

Sheet-steel housing, ergo gray (RAL 7032) or dust gray (RAL 7037)

7ND3521:

Plastic front door with matt border, with spring-loaded latch or with spring-loaded latch and lock.

7ND3590, 7ND3560:

Front door with lock and glass pane, front frame dust gray (RAL 7037).

Frame width:

7.5 mm/12 mm (housing format 288 x 144)

9 mm/15 mm (housing format 288 x 288)

Front dimensions to DIN 43831.

Dimensions and panel cut-outs are specified with the respective recorders.

Error limits and interference suppression

The recorders comply with class 0.5 of the regulations for electrical measuring instruments. Any differences are listed in the Technical data.

The interference suppression St_U is specified in decibels. It is determined according to the following equation:

$$St_U = 20 \cdot \log_{10} \frac{U_{St}}{U_{Sig}} \text{ dB}$$

U_{St} Measured value of the interference signal
 U_{Sig} Determined value of the wanted signal

The worst condition is used in each case for the frequency and phase position of the interference. Since there are two manners in which the interference can affect the measuring circuit (common-mode or series-mode), two values in decibels are always required to completely specify the interference suppression.

The increasing energy density in modern plants means that it is advisable to suppress at least the induced series-mode interference at the point of occurrence (e.g. using commercially available contactors).

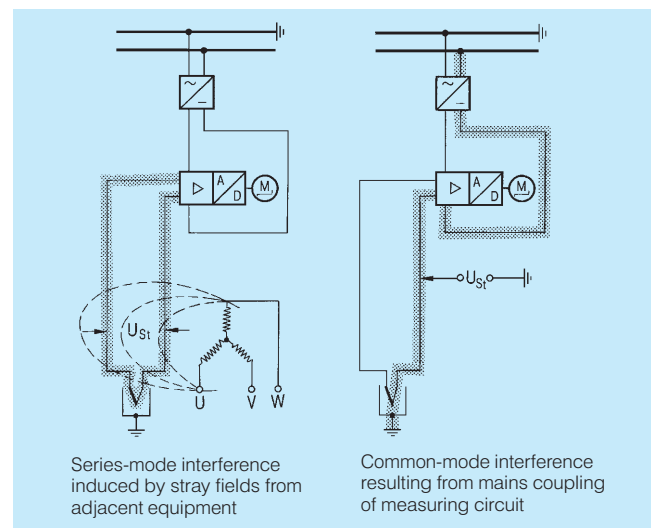

Fig. 3/1 Generation of interference signals

Limit monitoring

The limit monitoring functions of the hybrid recorders output a binary signal when programmed limits are violated. Two limits (opto isolator outputs) can be programmed for each channel.

Hybrid recorders

Technical explanations

Features

The VARIOGRAPH hybrid recorder has up to 12 channels for analog signals and/or 6 channels for digital signals (via serial interface and/or digital input/output). In addition, one of the channels 1 to 7 can be programmed to measure the mains frequency, and another to measure the terminal temperature. The minimum scanning cycle for all channels is 120 ms, and the maximum 3 s.

The recorder can be used as a multipoint or line recorder. Its fiber pen assembly records the measured values from up to 12 channels graphically and/or alphanumerically in 6 freely-selectable colors. The recorder can monitor the maximum and/or minimum values of measured variables in static or dynamic mode, and mark these on the chart by symbols with the channel No. and also with text or the time if required. Chart rolls are used, or also fanfold packs with the 7ND3521.

Further features of the VARIOGRAPH hybrid recorder:

- Permanent recording, or recording on event
- 2 different programs
- Menu-based programming with IR remote control unit
- Communication in 3 languages
- Display with selectable measured-value representation
- Measured-value buffer to cover the time required to replace the chart or pen assembly.

Input range

The input range is the electrical range of the instrument amplifier (measuring limits). The ranges are adapted by programming or by using plug-in jumpers.

Example:

- a): - 20 to + 20 mA for DC I as measured variable
- b): - 10 to + 60 mV for TC as measured variable
- c): - 20 to + 20 mA with function (for other physical variables)

The recording properties (measuring accuracy) of the instruments always refer to the input range.

Measuring range

Example:

- a): For DC U/I as measured variable:
Measuring range = input range
e.g.: - 20 mA to + 20 mA
- b): For direct connection of TC/RTD/R:
The measuring range is the range assigned to the input range with dimension (and linearization for TC and RTD).
e.g.: - 100 °C to + 900 °C for TC, type J
- c): For any dimensions/other physical variables:
The measuring range is defined by programming a "Function".
e.g.: 4 mA to 20 mA corresponds to 0 to 250 t/h, thus:
measuring range = 0 to 250 t/h.

Recording and display range "Analog"

The recording and display range "Analog" defines the part of the measuring range which can be recorded and graphically displayed on the chart or as a bargraph.

This range is freely-programmable within the measuring range by input of "Left value" and "Right value".

Example:

- a) 5 mA to 15 mA for DC I as measured variable,
measuring range - 20 mA to + 20 mA
- b): 100 °C to 700 °C for TC, type J,
measuring range - 100 °C to + 900 °C
- c): 50 t/h to 200 t/h via "Function",
measuring range 0 t/h to 250 t/h

Recording and display range "Digital"

The recording and display range "Digital" defines the range which can be displayed or printed as a digital value.

This range is identical to the measuring range. Thus the digital recording and display range may be larger than the analog recording and display range.

Example:

- a): - 20 mA to + 20 mA for DC I as measured variable
- b): - 100 °C to 900 °C for TC, type J
- c): 0 t/h to 250 t/h via "Function"

Standards

The recorders comply with the following standards:

- Housing: DIN 43 700, DIN 43 831
- Error limits: IEC 484 (DIN 43 782)
- Degree of protection: IEC 529 or EN 60 529
- Climate: IEC 68-2-1/2
- Mechanical stress: IEC 68-2-6
- Electric protection: IEC 1010-1 (EN 61 010-1, VDE 0411 Part 1)
- Electromagnetic compatibility: the protection objectives of the EMC guideline 89/336/EEC with respect to interference suppression to EN 50 081-1 and noise immunity to EN 50 082-2 of 03/95 are complied with.
- Interference suppression: VDE 0875 Part 11 (CISPR 11)
- Noise immunity: IEC 1000-4-...

Chart drive

A program-controlled stepping motor is responsible for the time-synchronous chart drive.

In the VARIOGRAPH hybrid recorder, the drive controls a sprocket wheel, and the sprockets engage in the perforations of the chart paper and thus transport the latter. The chart paper is tightened in the longitudinal direction by a take-up spool driven by the drive via a slip coupling.

Event marking system

The event marking system records an event (e.g. the switching on or off of a pump) by recording a binary variable (square-wave recording).

Chart paper

Chart paper for VARIOGRAPH hybrid recorders

The absorptive capacity of the ink paper is optimally matched to fiber pens. The paper has a very smooth surface so that the frictional resistance of the fiber pens is low.

Types of chart paper

R o l l: low-price recording with greatest possible visible trace length.

F a n f o l d: (only for 7ND3521): fast access possible even to recordings made a long time earlier. Easy finding of specific positions by flipping through like in a book.

Chart paper graduations

(see Figs. 3/2 to 3/3 for examples)

■ Range graduation

The recording width is divided linearly by longitudinal lines. Every fifth line is thicker than those in between.

Please contact us if you require chart paper with a non-linear range graduation or with printed text at regular intervals – e.g. range numbers, dimensions and measuring point names.

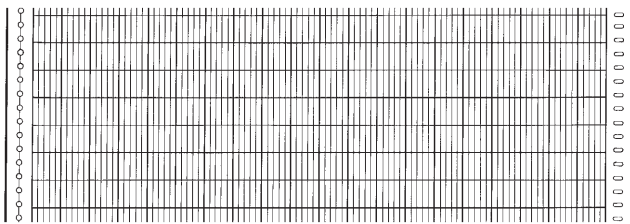

Fig. 3/2 Chart paper 230 mm wide, recording width 210 mm, 100 linear divisions (scale approx. 1:3)

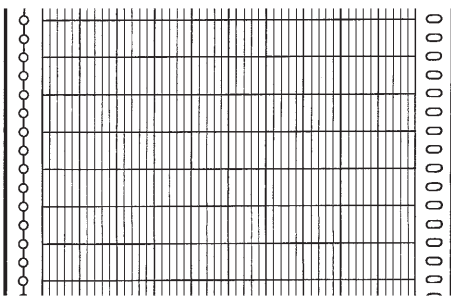

Fig. 3/3 Chart paper 120 mm wide, recording width 100 mm, 50 linear divisions (scale approx. 1:2)

Parameterization software

The SIMATIC PDM software permits you to use your PC for convenient dialog with the hybrid recorders.

Possible configurations

Various configurations are possible when operating the hybrid recorders via a PC:

Point-to-point operation

This is possible with the VARIOGRAPH by using the SIPROM R-VARIOGRAPH software and a null modem cable.

Bus operation

No standard solutions for bus operation exist for the VARIOGRAPH. Customer-specific solutions can be configured.

Hybrid recorders

Ordering information

Ordering information

Standard models are listed in the Ordering data. The technical data contain additional data for further designs, e.g. applications and power supply.

If designs are required for which no information is included in the technical data, please inquire whether the desired model is technically possible.

When ordering, please state:

- Order No.
- Order code, if applicable
- Any plain text required (e.g. inscription of measuring point label, information on the measuring ranges).

Example for ordering:

Required recorder:

VARIOGRAPH 7ND3590 hybrid recorder

Format 288 x 144

For installation in panel with basic grid 72 x 72

Power supply DC 24 V

6 channels

6 freely-adjustable/programmable measuring ranges (according to signal modules fitted)

Channels 1 to 3: fitted with signal module DC U/I

Channels 4 to 6: fitted with signal module DC U/I

Electronic alarm output

Door with low-reflection glass

Measuring point label inscribed "Transformer station south" (channel 1), "Main substation 1" (channel 2), "Total current" (channel 3), "Total power output" (channel 4), "Speed turbine 1" (channel 5), "Imported power" (channel 6)

The Ordering data for this recorder must then be as follows (according to page 3/17):

Order No.: 7ND3590-2BB13-1DG9

Order code: R1Y

Plain text: Measuring point inscription:
Channel 1: Transformer station south
Channel 2: Main substation 1
Channel 3: Total current
Channel 4: Total power output
Channel 5: Speed turbine 1
Channel 6: Imported power

Note:

The following designations are used in this section for the signal modules/measured variables:

DC U/I: DC voltage/direct current

AC U/I: AC voltage/alternating current

RTD: Resistance temperature detector (resistance thermometer)

TC: Thermocouple

R: Resistance

Hybrid recorders

VARIOGRAPH 7ND3521, 7ND3590, 7ND3560

Universal hybrid recorders
144 x 144, 288 x 144 and 288 x 288

Universal hybrid recorder VARIOGRAPH

7ND3521 (144 x 144)

7ND3590 (288 x 144)

7ND3560 (288 x 288)

12 channels for analog measured variables

Common features

- 3, 6 or 12 channels for analog variables; up to 6 additional channels via interface (max. total of 12 channels, however), without pen offset
- Microprocessor-based
- Recording with fiber recording head, max. 6 colors
- Short scanning cycle with intermediate data memory
- Recording cycle independent of measured value, use as line recorder or multipoint recorder
- Storage of 2 user programs, protected by 4-digit code number
- Operating modes:
 - Displays (numeric and/or analog as bargraph)
 - Curves
 - Tables
- No data loss for curves with tables (mixed operation)
- Measured variables (measurement via plug-in signal modules):
 - Direct current, DC voltage
 - Temperature (connection to thermocouples and resistance thermometers)
 - Resistance (2-wire or 3-wire systems)
- Freely-programmable measuring ranges and alarms
- Zooming
- Zoning
- Programmable alarm identification and output for each channel with limit violation
- Logic operations on alarms
- Text and scale printouts
- Real-time calendar clock, internal or external synchronization, e.g. by a master clock
- Date/time printout, channel identification and message text
- Operator prompting in German and English; French or Russian as option
- Operation and programming with infrared remote control unit and parameterization software (SIMATIC PDM)
- Coupling to interface-based automation systems via serial interfaces
- Recording paper: roll, or fanfold (only 7ND3521)
- Suitable for installation without interspacing
- Housing front: degree of protection IP 54



Fig. 3/4 VARIOGRAPH 7ND3521, format 144 x 144

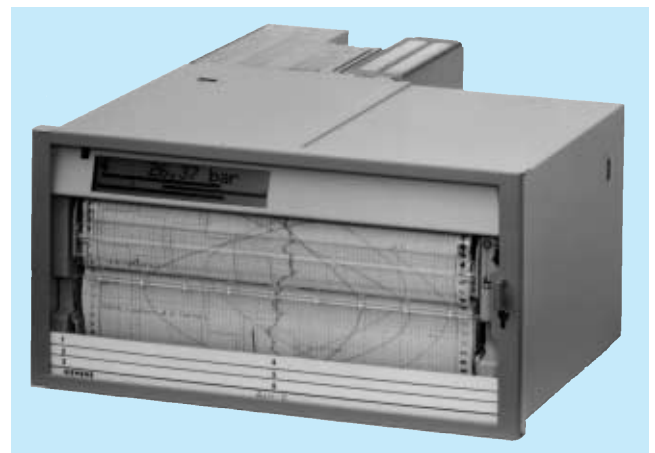

Fig. 3/5 VARIOGRAPH 7ND3590, format 288 x 144



Fig. 3/6 VARIOGRAPH 7ND3560, format 288 x 288

Hybrid recorders

VARIOGRAPH 7ND3521, 7ND3590, 7ND3560

Universal hybrid recorders
144 x 144, 288 x 144 and 288 x 288

3

Technical data, basic device	
Measurements	
Measuring procedure	Analog-to-digital conversion according to dual-slope procedure
Channels	
- Analog inputs	3, 6 or 12, connection via signal modules (channels 1 to 12)
- Digital inputs	6, connection via auxiliary modules "Serial interface" and/or "Digital input/output" (only for binary variables) (channels 7 to 12)
Scales	
- Printed in diagram	
Number	1 per channel, programmable
Generation	Automatic
Additional inscriptions	Channel number and dimension
- Mechanical on recorder (7ND3560 only)	Max. 4 divisions
Functions $y = f(x)$	6 freely-programmable assignments between the input variable (x) (signal range) and the output variable (y) (measuring range), e.g. linearization with max. 50 turning points each Dimension: 5 characters per dimension, freely-selectable per function, logic operations e.g. for control purposes
Measuring ranges	Adjustable/programmable for each range within the measuring limits of the signal modules
Programs	2 programs can be stored, selectable manually (internal/external) or via "Condition"
Available signal modules	
- 3-channel	7ND9400-8AA (DC U/I)
- 6-channel	7ND9400-8AF (DC U/I/TC/RTD/R) 7ND9400-8AJ (DC U/I/TC)
Available auxiliary modules	Serial interface 7ND9400-8BH Digital input/output 7ND9400-8BB
Error limits	Class 0.5, DIN 43 782
Basic device	0.3 % of recording width (100 mm)
Signal module 7ND9400-8AA	0.2 % with expansion factor of max. 4
Signal module 7ND9400-8AF	0.2 % with expansion factor of max. 5
Signal module 7ND9400-8AJ	0.2 % with expansion factor of max. 5 (spec. errors see pages 3/11 to 3/13)
Measured-value damping	Separate for each channel
Filter	1st order low-pass
Time constant	0 to 120 s, programmable in unit steps
Recording	
Recording range	"Left value" and "Right value" freely programmable
Data display	
- Graphic recording, curves	Line or multipoint recorder, freely-selectable color assignments, inscription with channel number and text or measured value
- Numeric recording, text	Data set with symbols, 1 device text, max. 16 characters, 12 channel texts, max. 16 characters each, 12 event texts, max. 53 characters each, freely-selectable color assignment
- Mixed recording	Alternate graphic and numeric recording
Recording procedure	Discontinuous with intermediate storage of data, pen offset compensated
Recording system	
- Pen assembly	Replaceable, with flexible fiber pen capillaries
- Colors	Violet, red, black, green, blue, brown
- Recording length	Approx. 1800 m

- Service life	Approx. 6 months
- Storage life	24 months in closed packing 1 month in device with climate to DIN IEC 654-1
- Character set	ASCII standard with upper-case and lower-case letters, Greek alphabet and special characters, selectable in 6 colors
- Length of text line	53 characters
- Character height	2.16 mm (standard)
Pen assembly drive	Program-controlled step motor
Carriage drive	Program-controlled step motor
Step length	7ND3521 7ND3560/90 0.125 mm = 0.125 % 0.125 mm = 0.06 %
Carriage speed	Max. 125 mm/s
Recording width	7ND3521 7ND3560/90 Max. 100 mm (selectable per channel) Max. 210 mm (selectable per channel)
Chart drive	Program-controlled step motor, class 0.005 to DIN 43 782
Step length	0.06 mm to 0.6 mm programmable
Fast forward	1 mm/s to 30 mm/s
Chart speeds	0 (off) 1 - 1.25 - 2 - 2.5 - 5 mm/h 10 - 15 - 20 - 30 - 40 mm/h 50 - 60 - 100 - 120 - 150 mm/h 180 - 200 - 240 - 300 mm/h 600 - 1200 ¹⁾ mm/h 600 ¹⁾ - 1200 ¹⁾ mm/h
Printing interval for data table	7ND3521 7ND3560/90 ∞ (off), 15 - 30 min 1 - 2 - 3 - 4 - 6 - 12 - 24 h
Chart paper	
Roll	7ND3521 7ND3560/90 31 m long, 120 mm wide 31 m long, 230 mm wide
Fanfold	7ND3521 16 m long, 120 mm wide
Visible chart length	
Roll	7ND3521/90 7ND3560 70 to 80 mm 200 mm
Fanfold	7ND3521 30 to 80 mm
Recording condition	Continuous recording or recording with "Condition", e.g. via alarms or their boolean operations
Display	
Display unit	Liquid crystal (DSTN)
Dot matrix	16 x 100
Characters	5 x 7 or 7 x 13 dots ASCII standard with upper-case and lower-case letters, Greek alphabet and special characters
Character height	6.85 mm or 12.85 mm
Data display	Number and dimension, 5 digits each
Bar display	0 to 100 %, resolution 1 %
Operation/programming	Via infrared remote control unit, menu-based, output of menu line on display of recorder, PC parameterization software
STATUS menu	Display and printout of device configuration, time, start table, code No., dialog address, device text
MODE menu	Chart speed, printing interval and display mode can be set in MODE A and MODE B, selectable manually (internal/external) or via "Condition"
PROGRAM menu	Parameters and recording conditions can be set in PROGRAM A and PROGRAM B, selectable manually (internal/external) or via "Condition"

¹⁾ Not to be recommended for the output of highly oscillating signals with a large amplitude and/or the output of longer strings (such as texts and tables of data) over a longer period because of the possibility of data losses.

Hybrid recorders

VARIOGRAPH 7ND3521, 7ND3590, 7ND3560

Universal hybrid recorders
144 x 144, 288 x 144 and 288 x 288

TEST menu	Calling of test functions
Operator prompting	German, English, French (Russian on request)
Limit monitoring	
Number of alarms	2 alarms per channel, programmable
Alarm output	Recording of a symbol and the channel number, optionally with text or time
- Static	On violation of upper or lower limit
- Dynamic (gradient)	On defined change in signal speed
Alarm output	Via auxiliary module "Digital input/output" (page 3/13)
Limit hysteresis	0.01 to 5 % of measuring range, programmable in 9 steps
Logic operations on alarms	AND, OR, EXOR, negation
Data memory	Recording buffer for a chart length of approx. 55 mm to cover the time for replacing chart paper or pen assembly
Real-time calendar clock	
Format	Year, month, day, hour, minute, second; 24-hour or 12-hour representation programmable
Program	Up to year 2048
Accuracy	Max. error 1×10^{-5} at 25 °C
Back-up on power failure	With 3-V lithium battery
External synchronization	Programmable by master clock via SYNC input or via power supply network
Control inputs	Passive, electrically isolated via opto isolator: START/STOP, CONTR. IN and SYNC. (Fig. 3/10)
Input resistance	$\geq 5 \text{ k}\Omega$
Low level	$\leq 5 \text{ V}$, min. -3 V
High level	$\geq 8 \text{ V}$, max. 30 V
General data	
Format	7ND3521 144 x 144 7ND3560 288 x 288 7ND3590 288 x 144
	} DIN 43 700 and DIN 43 831
Mounting facilities	Sheet-steel panel, panel or desk upright panel with basic grid dimensions 72 x 72, cabinet or sheet-steel desk upright panel
Mounting	
Panel mounting	To DIN 43 834-A-340
Desk and cabinet mounting	To DIN 43 834-A-230
Mounting position	To DIN 16 257
Operation with roll	Vertical - 30 ° to + 15 °
Operation with fanfold	Vertical - 15 ° to + 15 °
Climatic ambient conditions	To IEC 68-2-1/2/ DIN EN 60 068-2-1/2
Temperature of use	0 to 50 °C (max. 75 % rel. humidity at 25 °C, no condensation), change in temperature max. 10 K/h
Storage temperature range	-25 to +70 °C (max. 75 % rel. humidity at 25 °C, no condensation), change in temperature max. 20 K/h
Mechanical ambient conditions	
Vibrations during operation	To DIN IEC 68-2-6 5 to 9 Hz; 3.5 mm deflection 9 to 200 Hz; 10 m/s ² acceleration
Vibrations during storage and transport	To DIN IEC 68-2-6 5 to 9 Hz; 3.5 mm deflection 9 to 500 Hz; 10 m/s ² acceleration

Drop test for packed unit	To DIN EN 60 068-2-32, height < 0.8 m
Shock test during operation	To DIN IEC 68 Part 2-27 15 g, 11 ms
Resistance to earthquakes during operation	Vibrations in the three axes X, Y, Z to DIN IEC 68 Part 2-6 2 g, 1 octave/min., max. $\pm 10 \text{ mm}$ amplitude 2 g, 5 cycles, 1 h
Frequency range	5 ... 35 ... 5 Hz
Frequency range	10 ... 58 Hz, 58 ... 500 Hz
Protection class	I to IEC 348/DIN VDE 0411 Part 1
Degree of protection	EN 60 529 (IEC 529)
Terminals	IP 20
Housing, rear	IP 20
Housing door	IP 54
Test voltages	IEC 348/DIN VDE 0411 Part 1
Mains/housing	DC 2.1 kV
Control input/housing	AC 0.5 kV
Radio interference suppression	To DIN VDE 0871, limit class A
Power supply	
- AC/DC power pack 230 V	AC 50 to 60 Hz (- 5 to + 5 %) 110 to 240 V (- 15 to + 10 %), approx. 36 VA; DC 110 to 230 V ($\pm 10 \%$), 18 W
- AC/DC power pack 24 V	AC 50 to 60 Hz (- 5 to + 5 %) 24 V (- 15 to + 10 %), approx. 36 VA; DC 24 V (18 to 33 V), approx. 18 W
Type of connections	Screw terminals
- Terminal range	
For solid conductors	0.13 to 2,5 mm ²
For stranded conductors	0.13 to 1.5 mm ² (conductor sleeves)

3

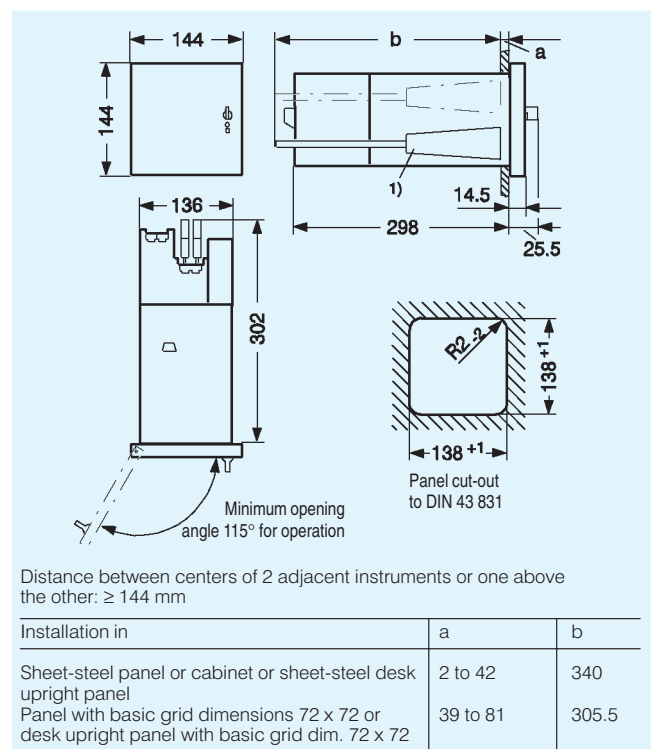

Fig. 3/7 Universal hybrid recorder VARIOGRAPH 144 x 144, dimensions

1) The clamps can also be fitted at the top and bottom.

Hybrid recorders

VARIOGRAPH 7ND3521, 7ND3590, 7ND3560

Universal hybrid recorders
144 x 144, 288 x 144 and 288 x 288

3

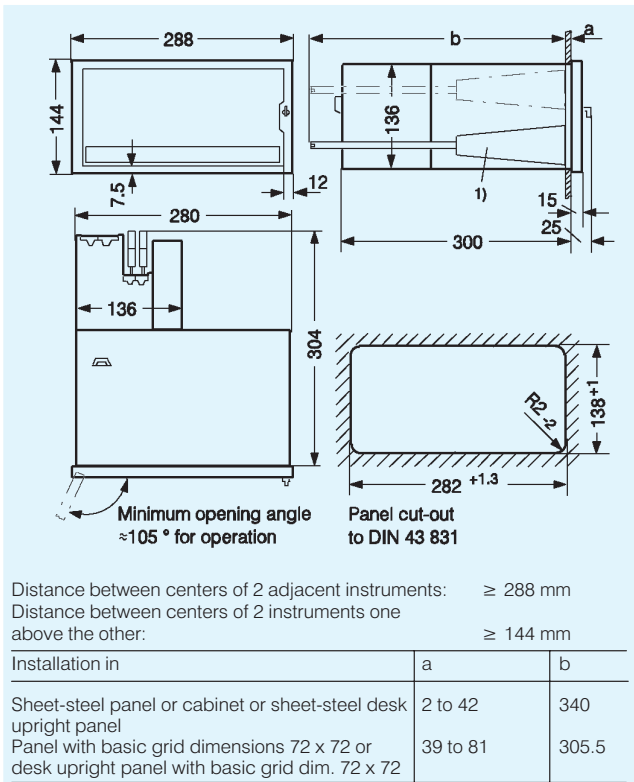

Fig. 3/8 Universal hybrid recorder VARIOGRAPH 288 x 144, dimensions

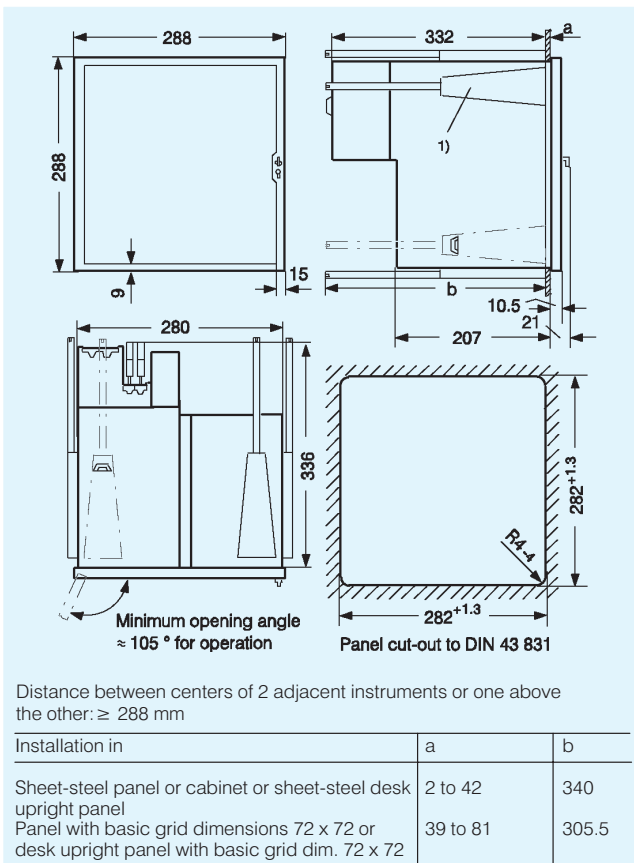

Fig. 3/9 Universal hybrid recorder VARIOGRAPH 288 x 288, dimensions

Front door	7ND3521	Plastic; with matt border, with spring-loaded latch or with spring-loaded latch and lock
Front frame	7ND3560/90	Gray; front door with lock and glass pane
Weight	7ND3521 7ND3560 7ND3590	Approx. 4 kg Approx. 8.5 kg Approx. 6 kg

Electromagnetic compatibility

Emitted interference

The targets of the EMC guideline 89/336/EEC with respect to radio interference suppression to EN 50 081-1 and interference rejection to EN 50 082-2 of 03/95 are observed.

Radio interference

Measured according to VDE 0875 Part 11 (CISPR 11)

Power supply
AC 110 to 240 V

Limit class B for shielded control cables

Interference rejection

Device-under-test	Influencing variable	Basic standard	Instrument	
			Test condition	Res ³⁾
Instrument	RF field AM	IEC 1000-4-3	10 V/m ²⁾	A
	RF field PM	IEC 1000-4-3	10 V/m	A
	Discharge	IEC 1000-4-2	6/8 kV	A
Process, measuring and control lines	RF conducted interference	IEC 1000-4-6	10 V	A
	Burst	IEC 1000-4-4	2 kV	A
AC/DC 24 V power supply	RF conducted interference	IEC 1000-4-6	10 V	A
	Burst	IEC 1000-4-4	2 kV	A
	Surge	IEC 1000-4-5	1/1 kV ⁴⁾	B
	Interruption	IEC SC77BWG3	20 ms/100 %	A
AC 110 to 240 V power supply	RF conducted interference	IEC 1000-4-6	10 V	A
	Burst	IEC 1000-4-4	2 kV	A
	Surge	IEC 1000-4-5	1/1 kV ⁵⁾	B
	Interruption	IEC SC77BWG3	20 ms/100 %	A
Earth connection	RF conducted interference	IEC 1000-4-6	10 V	A

1) The clamps can be fitted on all sides.

2) 3 V/m in the ranges 87 to 108, 174 to 230 and 470 to 790 MHz.

3) A = additional error during effect of interference referred to span of signal modules when using shielded signal and control cables (screen connected to PE conductor at both ends):

- 7ND9400-8AA max. 0.2 %

- 7ND9400-8AF max. 0.2 %, but 0.5 % in range -10 to +60 mV and in the TC ranges

- 7ND9400-8AJ max. 0.2 %, but 0.5 % in the range -10 bis +60 mV and in the TC ranges

When using non-shielded cables, the above error may be up to 3 % in the sensitive signal and TC ranges (thermocouples), and 0.5 % in the other ranges.

B = interference possible during effect

4) 1 kV symmetric, 1 kV asymmetric

5) 1 kV symmetric, 2 kV asymmetric

Hybrid recorders

VARIOGRAPH 7ND3521, 7ND3590, 7ND3560

Universal hybrid recorders
144 x 144, 288 x 144 and 288 x 288

Technical data, signal modules				
Signal module DC U/I, 7ND9400-8AA				
Number of channels		3, electrically isolated		
Measured variables		Electrical variables (DC U/I)		
Measuring range (adjustable)	Resolution Graphic min.	Numeric	Error ¹⁾ Absolute	Relative % of meas. value
DC voltage - 1 to + 1 V -10 to + 10 V	100 μ V 1 mV	100 μ V 1 mV	0.75 mV 7.5 mV	0.025 0.025
Direct current - 10 to + 10 mA - 20 to + 20 mA	1 μ A 2 μ A	1 μ A 2 μ A	7.5 μ A 15 μ A	0.025 0.025
Recording ranges		Programmable		
Input resistance		50 k Ω /V		
DC voltage		50 Ω (\pm 10 mA range)		
Direct current		25 Ω (\pm 20 mA range)		
Potential		Max. permissible 24 V against protective earth conductor: only circuits with safe electrical isolation from the power supply are permissible		
Measuring cycle with 1 or 2 signal modules in the VARIOGRAPH				
With 50-Hz mains frequency		120 ms		
With 60-Hz mains frequency		100 ms		
With DC power supply		120 or 100 ms, selectable ²⁾		
Measuring duration with 1 or 2 signal modules in the VARIOGRAPH				
With 50-Hz mains frequency		20 ms		
With 60-Hz mains frequency		16.6 ms		
With DC power supply		20 or 16.6 ms, selectable ²⁾		
Resolution and errors		According to table above		
Additional temperature error		30 ppm of span per K		
Typical		300 ppm of span per K		
Maximum				
Continuous overload capacity		Max. 30 V		
Voltage input		Max. 80 mA		
Current input				
Surge overload capacity (5 s)		Max. 30 V		
Voltage input		Max. 100 mA		
Current input				
Analog-to-digital conversion		1 dual-slope converter/channel, resolution 14 ^{1/2} bits		
Series-mode rejection		\geq 60 dB for mains frequency		
Common-mode rejection		\geq 90 dB for mains frequency		
Signal connection		Screw terminals		
Terminal range		0.13 to 2.5 mm ²		
For solid conductors		0.13 to 1.5 mm ² (conductor sleeves)		
For stranded conductors				
Test voltages		IEC 348/DIN VDE 0411 Part 1		
Signal input/housing		AC 500 V		
Signal input/signal input		AC 500 V		
Weight		Approx. 150 g		
Signal module DC U/I/TC/RTD/R, 7ND9400-8AF				
Number of channels		6, electrically isolated via relays		
Measured variables		• Electrical variables (DC U/I/R)		
Measuring ranges		Adjustable/programmable according to following table		

1) Reference conditions: ambient temperature 23 °C \pm 2 °C, relative humidity 55 % \pm 10 %.

2) Depending on frequency of adjacent AC network.

Recording ranges	Programmable
Input resistance with:	
DC voltage measurements	10 M Ω
Direct current measurements	2.5 Ω
Current source for resistance measurements	Approx. 1 mA, built-in
Permissible line resistance with resistance measurements	
- 3-wire system	$R_L \leq R_E - R_M$, max. 100 Ω
- 2-wire system	$R_L \leq 0.5 (R_E - R_M)$
	R_E 600 Ω full-scale value
	R_L Line resistance per conductor
	R_M Measuring resistance for full-scale value of recorder
Detection of line breakage with DC voltage measurements	Present
• Temperature via thermocouple (TC)	
Measuring ranges	Adjustable/programmable according to following table
Dimension	$^{\circ}$ C or K, selectable
Recording ranges	Programmable
Reference temperature	
Internal	Via measurement of terminal temperature, additional error \leq 0.6 K
External	Via reference channel or - 50 to + 150 $^{\circ}$ C, programmable, 223 to 423 K, programmable
Potential	Max. permissible 24 V against PE conductor; only circuits with safe electrical isolation from the power supply are permissible
Input resistance	10 M Ω
Detection of line breakage	Present
• Temperature via resistance thermometer (RTD)	
Measuring ranges	Adjustable/programmable according to following table
Dimension	$^{\circ}$ C or K, selectable
Recording ranges	Programmable
Potential	Max. 24 V
Input resistance	10 M Ω
Current source	Approx. 1 mA, built-in
Permissible line resistance	
3-wire system	$R_L \leq R_E - R_M$, max. 100 Ω
2-wire system	$R_L \leq 0.5 (R_E - R_M)$
	R_E 600 Ω full-scale value
	R_L Line resistance per conductor
	R_M Measuring resistance for full-scale value of recorder
Measuring cycle	3 s
Measuring duration	
With 50-Hz mains frequency	20 ms
With 60-Hz mains frequency	16.6 ms
With DC power supply	20 or 16.6 ms, selectable depending on frequency of adjacent AC network
Resolution and errors	According to following table
Additional temperature error	
Typical	15 ppm of span per K
Maximum	150 ppm of span per K
Continuous overload capacity	
Voltage input; current input	Max. 24 V; max. 225 mA
Surge overload capacity (5 s)	
Voltage input	Max. 24 V
Current input	Max. 300 mA
Analog-to-digital conversion	1 common dual-slope converter, resolution 13 ^{1/2} bits

Hybrid recorders

VARIOGRAPH 7ND3521, 7ND3590, 7ND3560

Universal hybrid recorders
144 x 144, 288 x 144 and 288 x 288

3

Series-mode rejection	≥ 60 dB for mains frequency
Common-mode rejection	≥ 90 dB for mains frequency
Signal connection	Screw terminals
Terminal range	
For solid conductors	0.13 to 2.5 mm ²
For stranded conductors	0.13 to 1.5 mm ² (conductor sleeves)
Test voltages	IEC 348/DIN VDE 0411 Part 1
Signal input/housing	AC 500 V
Signal input/signal input	DC 500 V
Weight	Approx. 440 g

Measuring range	Resolution Graphic min.	Numeric	Error ¹⁾	
			Absolute	Relative % of meas. value
DC voltage - 10 to + 60 mV - 100 to + 600 mV	6 μV 60 μV	6 μV 60 μV	20 μV 130 μV	0.02 0.02
Direct current - 4 to + 20 mA - 40 to + 200 mA	3 μA 30 μA	3 μA 30 μA	10 μA 100 μA	0.03 0.03
Resistance 0 to 600 Ω	60 mΩ	0.1 Ω	0.2 Ω	0.04

Thermocouple to DIN IEC 584				
Type J Fe/Cu Ni - 100 to + 1000 °C 173 to 1273 K	0.2 °C 0.2 K	0.2 °C 0.2 K	0.3 °C 0.3 K	0.04 0.04
Type K Ni Cr/Ni 0 to 1200 °C 273 to 1473 K	0.2 °C 0.2 K	0.2 °C 0.2 K	0.5 °C 0.5 K	0.04 0.04
Type T Cu/Cu Ni 0 to 400 °C 273 to 673 K	0.2 °C 0.2 K	0.2 °C 0.2 K	0.3 °C 0.3 K	0.04 0.03
Type S Pt 10% Rh/Pt 0 to 1600 °C 273 to 1873 K	0.6 °C 0.6 K	0.6 °C 0.6 K	1.5 °C 1.5 K	0.05 0.05
Type R Pt 13% Rh/Pt 0 to 1600 °C 273 to 1873 K	0.6 °C 0.6 K	0.6 °C 0.6 K	1.5 °C 1.5 K	0.05 0.05

Thermocouple to DIN 43 710				
Type L Fe-Cu Ni - 100 to + 900 °C 173 to 1173 K	0.2 °C 0.2 K	0.2 °C 0.2 K	0.3 °C 0.3 K	0.04 0.04
Type U Cu-Cu Ni 0 to 400 °C 273 to 673 K	0.2 °C 0.2 K	0.2 °C 0.2 K	0.3 °C 0.3 K	0.04 0.03

Resistance thermometer				
Pt 100 to DIN IEC 751 - 200 to + 850 °C 73 to 1123 K	0.2 °C 0.2 K	0.2 °C 0.2 K	0.4 °C 0.4 K	0.05 0.04
Pt 200 according to manufacturer's data - 200 to + 250 °C 73 to 523 K	0.1 °C 0.1 K	0.1 °C 0.1 K	0.2 °C 0.2 K	0.05 0.02
Ni 100 to DIN 43 760 - 60 to + 240 °C 213 to 513 K	0.1 °C 0.1 K	0.1 °C 0.1 K	0.2 °C 0.2 K	0.05 0.03

Signal module DC U/TC, 7ND9400-8AJ

Number of channels	6, electrically isolated via semiconductor relays (reverse resistance > 2 GΩ at 100 V DC, breakdown voltage > 200 V DC)
Measured variables	<ul style="list-style-type: none"> Electrical variables (DC U/I)
Measuring ranges	Adjustable/programmable according to following table
Recording ranges	Programmable
Input resistance with:	
DC voltage measurements	10 MΩ
Direct current measurements	2.5 Ω
<ul style="list-style-type: none"> Temperature via thermocouple (TC) 	
Measuring ranges	Adjustable/programmable according to following table
Dimension	°C or K, selectable
Recording ranges	Programmable
Reference temperature	
Internal	Via measurement of terminal temperature, additional error ≤ 0.6 K
External	Via reference channel or - 50 to + 150 °C, programmable, 223 to 423 K, programmable
Input resistance	10 MΩ
Detection of line breakage	40 to 500 kΩ, dependent on input signal Source resistance ≤ 2 kΩ
Potential	Max. permissible 24 V against PE conductor: only circuits with safe electrical isolation from the power supply are permissible
Measuring cycle	1.5 s with 1 to 12 channels
Measuring duration	
With 50-Hz mains frequency	20 ms
With 60-Hz mains frequency	16.6 ms
With DC power supply	20 or 16.6 ms, selectable depending on frequency of adjacent AC network
Resolution and errors	According to following table
Additional temperature error	
Typical	15 ppm of span per K
Maximum	150 ppm of span per K
Continuous overload capacity	
Voltage input, temperature	Max. 24 V
Current input	Max. 250 mA
Overload capacity	Max 5 % of full-scale value
Analogue-to-digital conversion	1 common dual-slope converter, resolution 13 ¹ / ₂ bits
Series-mode rejection	≥ 60 dB for mains frequency
Common-mode rejection	≥ 90 dB for mains frequency
Signal connection	Screw terminals
Terminal range	
For solid conductors	0.13 to 2.5 mm ²
For stranded conductors	0.13 to 1.5 mm ² (conductor sleeves)
Test voltages	According to DIN IEC 1010-1; the test specifications must be observed when retesting
Signal input/housing	DC 500 V
Weight	Approx. 200 g

¹⁾ Reference conditions: ambient temperature 23 °C ± 2 °C, relative humidity 55 % ± 10 %.

Hybrid recorders

VARIOGRAPH 7ND3521, 7ND3590, 7ND3560

Universal hybrid recorders
144 x 144, 288 x 144 and 288 x 288

Measuring range	Resolution		Error ¹⁾	
	Graphic min.	Numeric	Absolute	Relative % of meas. value
DC voltage - 10 to + 60 mV - 0.1 to + 1 V	6 μ V 100 μ V	6 μ V 100 μ V	20 μ V 250 μ V	0.02 0.02
Direct current - 4 to + 20 mA	3 μ A	3 μ A	10 μ A	0.03
Thermocouple to DIN IEC 584				
Type J Fe/Cu Ni -100 to +1000 °C 173 to 1273 K	0.2 °C 0.2 K	0.2 °C 0.2 K	0.4 °C 0.4 K	0.04 0.04
Type K Ni Cr/Ni 0 to 1200 °C 273 to 1473 K	0.2 °C 0.2 K	0.2 °C 0.2 K	0.5 °C 0.5 K	0.04 0.04
Type T Cu/Cu Ni 0 to 400 °C 273 to 673 K	0.2 °C 0.2 K	0.2 °C 0.2 K	0.5 °C 0.5 K	-0.04 -0.03
Type S Pt 10% Rh/Pt 0 to 1600 °C 273 to 1873 K	0.6 °C 0.6 K	0.6 °C 0.6 K	3 °C 3 K	-0.05 -0.05
Type R Pt 13% Rh/Pt 0 to 1600 °C 273 to 1873 K	0.6 °C 0.6 K	0.6 °C 0.6 K	3 °C 3 K	-0.05 -0.05
Thermocouple to DIN 43 710				
Type L Fe-Cu Ni -100 to + 900 °C 173 to 1173 K	0.2 °C 0.2 K	0.2 °C 0.2 K	0.4 °C 0.4 K	0.04 0.04
Type U Cu-CuNi 0 to 400 °C 273 to 673 K	0.2 °C 0.2 K	0.2 °C 0.2 K	0.5 °C 0.5 K	-0.04 -0.03

Auxiliary module: "Serial interface" 7ND9400-8BH	
Interfaces	20-mA current loop (TTY), RS-232, RS-485, electrically isolated from basic electronics
Procedures	Xon/Xoff ETX-ACK/NAK
Transmission rates	110/150/300/600/1200/2400/4800/9600/19200 bits/s
Data formats	Decimal ASCII Real Hex ASCII Real BCD ASCII
Operating modes	Manual/remote operation, Listen Only, Talk Only
External power supply	DC 18 to 30 V
Current consumption	Max. 125 mA
Connection	Subminiature socket, 25-contact
Weight	Approx. 90 g

Auxiliary module: "Digital input/output" 7ND9400-8BB	
Inputs	6 passive inputs, electrically isolated from basic electronics via opto isolator
Input resistance	$\geq 5 \text{ k}\Omega$
Low level	$\leq 5 \text{ V}$, min. - 3 V
High level	$\geq 8 \text{ V}$, max. 30 V
Polarity reversal protection	Up to 40 V
Outputs	8 outputs, electrically isolated from basic electronics via opto isolator
Technology	Semiconductor drivers, short-circuit-proof and overload-proof
Output current	Max. 150 mA
Low level	$\leq 0.3 \text{ V}$
High level	$\geq U_V - 2 \text{ V}$
	U_V : power supply
External power supply	DC 18 to 30 V
Current consumption	
Typical	60 mA (all outputs inactive)
Maximum	1260 mA (all outputs active)
Test voltages	IEC 348/DIN VDE 0411 Part 1
Input/output/housing	AC 500 V
Connection	Subminiature plug, 25-pin
Weight	Approx. 80 g

Infrared remote control unit 7ND9190-8AA	
Transmission mode	Pulse-modulated infrared signal (biphase coding)
Range	Approx. 5 m, depending on state of battery
Radiation angle	Approx. 30°
Number of keys	30
Functions	See Fig. 3/17
Temperature of use	0 to 50 °C
Storage temperature range	- 25 to + 70 °C
Permissible relative humidity	Max. 75 %, no condensation
Climatic class	2 to VDI/VDE 3540, but KWF DIN 40 040
Degree of protection	IP 40 EN 60 529
Battery	4 alkaline batteries Micro type 4003, IEC LR 6
- Voltage	4 x 1.5 V
- Service life	
With low usage	Approx. 1 year
With high usage	Approx. 100 hours
Dimensions (W x H x D)	57 mm x 23 mm x 135 mm
Weight	Approx. 110 g (including battery)

¹⁾ Reference conditions: ambient temperature 23 °C \pm 2 °C, relative humidity 55 % \pm 10 %.
 $F = F_{\text{abs}} + F_{\text{rel}} \cdot \text{IMWI}$ (with DC voltage and direct current)
 $F = F_{\text{abs}} [^\circ\text{C}] + F_{\text{rel}} \cdot \text{IMW} [^\circ\text{C}]$ or $F = F_{\text{abs}} [\text{K}] + F_{\text{rel}} \cdot \text{IMW} [\text{K}] \cdot 273 \text{ K}$ I (with thermocouples)

Hybrid recorders

VARIOGRAPH 7ND3521, 7ND3590, 7ND3560

Universal hybrid recorders
144 x 144, 288 x 144 and 288 x 288

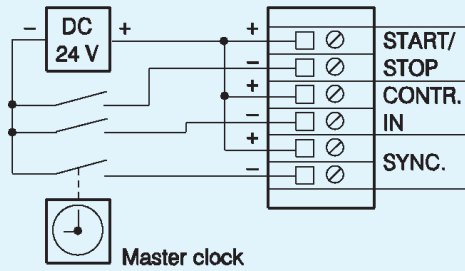

START/STOP Beginning/end of measurement
CONTR. IN Mode/program switchover/recording conditions
SYNC. External synchronization of calendar clock by a master clock or by a VARIOGRAPH as the control unit

Fig. 3/10 VARIOGRAPH 7ND35..., connection of control signal lines

3

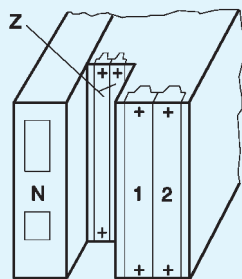

N Power pack
Z Auxiliary module slots
1 Signal module slot 1 (position 1)
2 Signal module slot 2 (position 2 with two 3-channel signal modules or two 6-channel signal modules 7ND9400-8AJ)

Fig. 3/11 VARIOGRAPH 7ND..., rear view

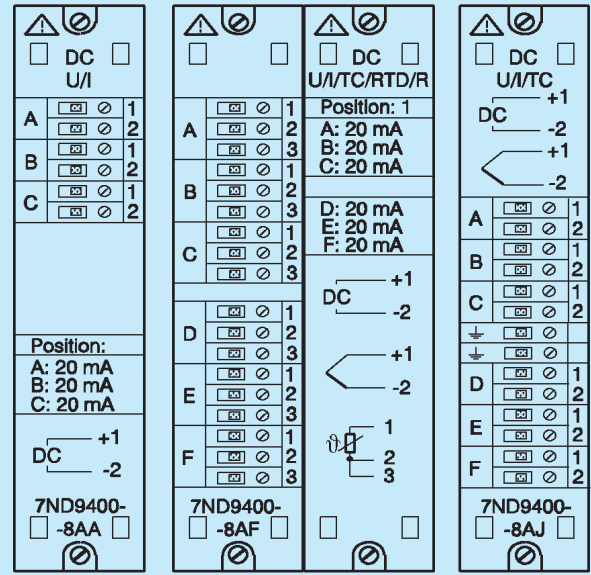

DC U/I
Signal module, 3-channel
Signal connections
Signal module in slot 1 (Fig. 3/11), position 1, A to C: channels 1 to 3
Signal module in slot 2 (Fig. 3/11), position 2, A to C: channels 4 to 6

DC U/TC/RTD/R
Signal module, 6-channel
Signal connections
Signal modules in slots 1 and 2 (Fig. 3/11), position 1, A to F: channels 1 to 6

DC U/TC
Signal module, 6-channel
Signal connections
Signal modules in slot 1 or 2 (Fig. 3/11), position 1, A to F: channels 1 to 6, position 2, A to F: channels 7 to 12

Fig. 3/13 VARIOGRAPH 7ND35..., connection diagrams for the signal modules (setting on delivery: all channels in basic setting 20 mA)

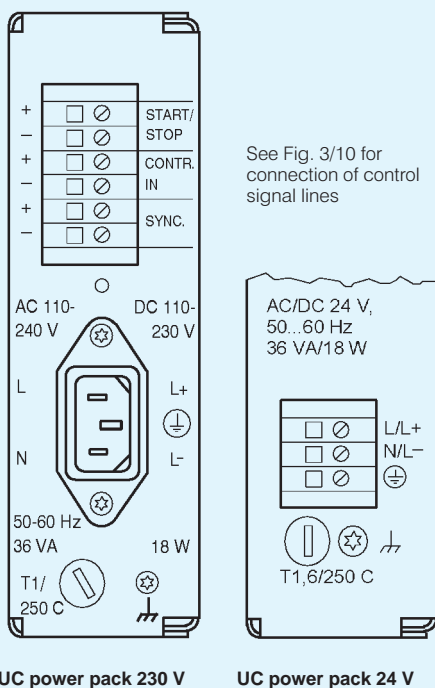

See Fig. 3/10 for connection of control signal lines

UC power pack 230 V

UC power pack 24 V

Fig. 3/12 VARIOGRAPH 7ND35..., connection for power pack

Hybrid recorders

VARIOGRAPH 7ND3521, 7ND3590, 7ND3560

Universal hybrid recorders
144 x 144, 288 x 144 and 288 x 288

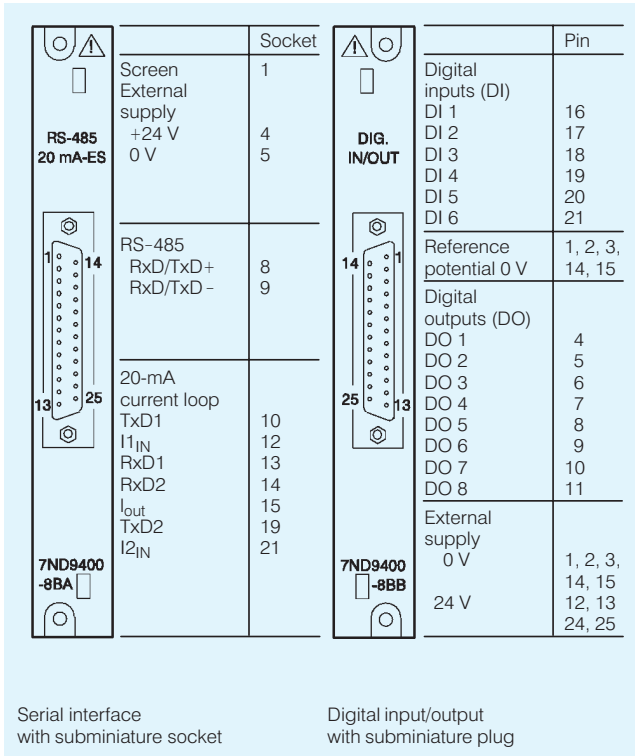

Fig. 3/14 VARIOGRAPH 7ND35..., connection for the auxiliary modules

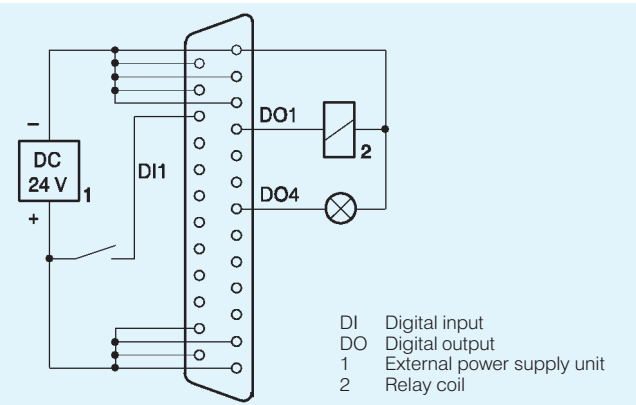

Fig. 3/15 Digital input/output, connection example



Fig. 3/16 Infrared remote control unit 7ND9190-8AA

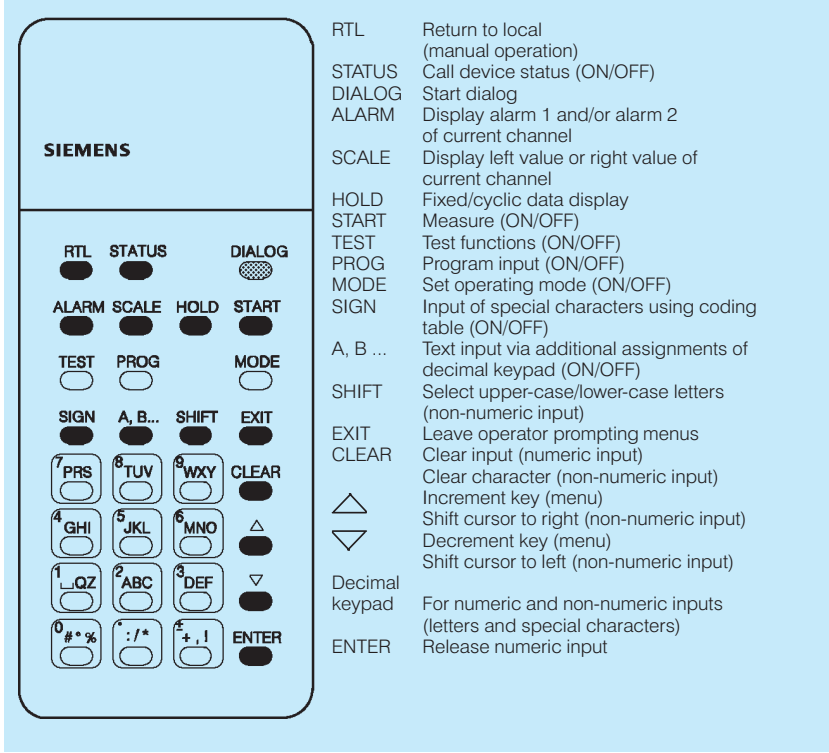

Fig. 3/17 Infrared remote control unit 7ND9190-8AA

Hybrid recorders VARIOGRAPH 7ND3521

Universal hybrid recorder 144 x 144

3

Ordering data		Order No.	Order code	Price		
VARIOGRAPH Universal hybrid recorder, front dimensions 144 x 144 With recording unit for rolls or fanfold paper						
Power supply AC 50 to 60 Hz 110 to 240 V, DC 110 to 230 V AC 50 to 60 Hz 24 V, DC 24 V						
Signal modules (analog inputs)	Measured variables/limits				Channels	Meas. cycle
Without sig. mod.	-				1 to 3 4 to 6	-
Signal module, 3-channel DC U/I ¹⁾	DC voltage / ± 10 V Direct current / ± 20 mA				Fitted Not fitted ²⁾	120 ms
Signal module, 6-channel DC U/I/TC/RTD/R ¹⁾	DC voltage / -100 mV, +600 mV Direct current / -40 mA, +200 mA Resistance / 0 Ω, 600 Ω Temperature via thermocouple or resistance thermometer				Fitted	3 s
Signal module, 6-channel DC U/I/TC ¹⁾	DC voltage / -10 mV, +1 V Direct current / -4 mA, +20 mA Temperature via thermocouple				1 to 6 7 to 12	1.5 s
Auxiliary modules (digital inputs and outputs)	Without auxiliary modules ²⁾ With serial interface With digital input/output With serial interface and digital input/output				Fitted Fitted	
Housing door in protection IP 54³⁾	Without lock Standard door Low-reflection door With lock Standard door Low-reflection door					
Installation	In sheet-steel panel, cabinet or sheet-steel desk upright panel, with 2 clamps C72165-A405-B177 In panel or desk upright panel with basic grid dimension 72 x 72, with one set of mounting parts C79453-A3011-D100					
Measuring-point label	Unlabelled Labelled (max. 29 digits per channel) Specify desired inscription in plain text:					

Further designs on request.

Accessories, spare parts, consumable material and conversion parts on page 3/19.

Available ex stock

Note:

Operation always requires a remote control unit 7ND9190-8AA.

¹⁾ Basic setting on delivery: all channels 20 mA.

²⁾ Can be upgraded (see page 3/19).

³⁾ Also available in IP 51 for KWU control panels.

Scope of delivery:

VARIOGRAPH 7ND3521, fitted as ordered
1 roll of chart paper
1 accessories bag (pen assembly, lithium battery and 2 fuses)
2 clamps or 1 set of mounting parts
With auxiliary modules: 1 or 2 connectors
Instructions "Parameterization - a concise overview"

When using several VARIOGRAPH recorders it is sometimes only necessary to have one Manual. This is therefore not included in the delivery and must be ordered separately.

Hybrid recorders VARIOGRAPH 7ND3590

Universal hybrid recorder 288 x 144

3

Ordering data				Order No.	Order code	Price	
VARIOGRAPH Universal hybrid recorder, front dimensions 288 x 144 With recording unit for rolls							
Power supply AC 50 to 60 Hz 110 to 240 V, DC 110 to 230 V AC 50 to 60 Hz 24 V, DC 24 V							
Signal modules (analog inputs)	Measured variables/limits	Channels					Meas. cycle
Without sig. mod.	-	1 to 3	4 to 6				-
Signal module, 3-channel DC U/I	DC voltage / ± 10 V Direct current / ± 20 mA ¹⁾	Fitted	Not fitted ²⁾				120 ms
Signal module, 6-channel DC U/I/TC/RTD/R ¹⁾	DC voltage / -100 mV, +600 mV Direct current / -40 mA, +200 mA Resistance / 0 Ω, 600 Ω Temperature via thermocouple or resistance thermometer	Fitted					3 s
Signal module, 6-channel DC U/I/TC ¹⁾	DC voltage / -10 mV, +1 V Direct current / - 4 mA, + 20 mA Temperature via thermocouple	1 bis 6	7 bis 12				1.5 s
Auxiliary modules (digital inputs and outputs)	Without auxiliary modules ²⁾ With serial interface With digital input/output With serial interface and digital input/output	Fitted	Not fitted				Fitted
Housing door	With lock	Standard door Door with low-reflection glass					
Installation	In sheet-steel panel, cabinet or sheet-steel desk upright panel, with 2 clamps C72165-A405-B177 In panel or desk upright panel with basic grid dimension 72 x 72, with one set of mounting parts C79453-A3011-D100						
Measuring-point label	Unlabelled Labelled (max. 29 digits per channel) Specify desired inscription in plain text:			1 9 R1Y			

Further designs on request.
Accessories, spare parts, consumable material and conversion parts on page 3/19.

Note:
Operation always requires a remote control unit 7ND9190-8AA.

¹⁾ Basic setting on delivery: all channels 20 mA.
²⁾ Can be upgraded (see page 3/19).

Scope of delivery:
VARIOGRAPH 7ND3590, fitted as ordered
1 roll of chart paper
1 accessories bag (pen assembly, lithium battery and 2 fuses)
2 clamps or 1 set of mounting parts
With auxiliary modules: 1 or 2 connectors
Instructions "Parameterization - a concise overview"

When using several VARIOGRAPH recorders it is sometimes only necessary to have one Manual. This is therefore not included in the delivery and must be ordered separately.

Hybrid recorders VARIOGRAPH 7ND3560

Universal hybrid recorder 288 x 288

3

Ordering data				Order No.	Order code	Price	
VARIOGRAPH Universal hybrid recorder, front dimensions 288 x 288 With recording unit for rolls							
<u>Power supply</u> AC 50 to 60 Hz 110 to 240 V, DC 110 to 230 V AC 50 to 60 Hz 24 V, DC 24 V							
<u>Signal modules (analog inputs)</u>	<u>Measured variables/limits</u>	<u>Channels</u> 1 to 3 4 to 6					<u>Meas. cycle</u>
Without sig. mod.	-	Not fitted ²⁾					-
Signal module, 3-channel DC U/I	DC voltage / ± 10 V Direct current / ± 20 mA ¹⁾	Fitted	Not fitted ²⁾				120 ms
Signal module, 6-channel DC U/I/TC/RTD/R ¹⁾	DC voltage / -100 mV, +600 mV Direct current / -40 mA, +200 mA Resistance / 0 Ω, 600 Ω Temperature via thermocouple or resistance thermometer	Fitted					3 s
Signal module, 6-channel DC U/I/TC ¹⁾	DC voltage / -10 mV, +1 V Direct current / - 4 mA, + 20 mA Temperature via thermocouple	1 bis 6 Fitted	7 bis 12 Not fitted Fitted				1.5 s
<u>Scale (mechanical on device)</u>	Scale graduation (max. 4 graduations possible) 0 to 100 % (for all channels) As specified in plain text						1 2
<u>Auxiliary modules (digital inputs and outputs)</u>	Without auxiliary modules ²⁾ With serial interface With digital input/output With serial interface and digital input/output						1 2 3 4
<u>Housing door</u>	With lock	Standard door Door with low-reflection glass					1C 1D
<u>Installation</u>	In sheet-steel panel, cabinet or sheet-steel desk upright panel, with 2 clamps C72165-A405-B177 In panel or desk upright panel with basic grid dimension 72 x 72, with one set of mounting parts C79453-A3011-D100			A G			
<u>Measuring-point label</u>	Unlabelled Labelled (max. 29 digits per channel) Specify desired inscription in plain text:			1 9	-Z Y01 R1Y		

Further designs on request (e.g. front dimensions 360 x 288 or black front frame)
Accessories, spare parts, consumable material and conversion parts on page 3/19.

Note:

Operation always requires a remote control unit 7ND9190-8AA.

1) Basic setting on delivery: all channels 20 mA.
2) Can be upgraded (see page 3/19).

Scope of delivery:

VARIOGRAPH 7ND3560, fitted as ordered
1 roll of chart paper
1 accessories bag (pen assembly, lithium battery and 2 fuses)
4 clamps or 1 set of mounting parts
With auxiliary modules: 1 or 2 connectors
Instructions "Parameterization - a concise overview"

When using several VARIOGRAPH recorders it is sometimes only necessary to have one Manual. This is therefore not included in the delivery and must be ordered separately.

Hybrid recorders

VARIOGRAPH 7ND3521, 7ND3590, 7ND3560

Universal hybrid recorders
144 x 144, 288 x 144 and 288 x 288

Ordering data	Order No.	Price
Accessories		
Infrared remote control unit ⁴⁾ with four 1.5-V alkaline batteries	7ND9190-8AA	
Manual ⁴⁾ ⁷⁾ including brief instructions and spare parts list		
- For 7ND3521 and 7ND3590	C79000-G7300-C79 C79000-G7376-C79 C79000-G7377-C79	
- For 7ND3560	C79000-G7300-C185 C79000-G7376-C185 C79000-G7377-C185	
Instructions "Parameterization - a concise overview"		
- German	C79000-M7300-C94	
- English	C79000-M7376-C94	
- French	C79000-M7377-C94	
Transport housing for VARIOGRAPH 7ND3521		
- For AC 230 V version	7ND9500-8AB1	
- For DC 24 V version	7ND9500-8AB2	
for VARIOGRAPH 7ND3590		
- For AC 230 V version	7ND9500-8AC1	
- For DC 24 V version	7ND9500-8AC2	
SIMATIC PDM software from V5.2 onwards (serial interface required) for parameterization of VARIOGRAPH 7ND3521, 7ND3590, 7ND3560 hybrid recorders; with documentation (as help file)	See catalog FI 01	
Consumable material		
Pen assembly (6 colors) , violet, red, black, green, blue and brown	7ND9001-8FB	
Chart paper 120 mm wide, roll , for 7ND3521 (approx. 31 m long, recording width 100 mm, 50 linear graduations, weight approx. 0.15 kg)		
Hours imprint	C72452-A94-B208 C72452-A94-B209 C72452-A94-B210 C72452-A94-B211 C72452-A94-B212	
For 10 mm/h		
20 mm/h		
60 mm/h		
120 mm/h		
Without		
Price per roll when ordering		
20		
60		
100		
Chart paper 230 mm wide, roll , for 7ND3560 or 7ND3590 (approx. 31 m long, recording width 210 mm, 100 linear graduations, without hours imprint, weight approx. 0.35 kg)	C72452-A98-B172	
Price per roll when ordering		
20		
60		
100		
Chart papier 120 mm wide, fanfold , for 7ND3521 (approx. 16 m long, recording width 100 mm, 50 linear graduations, weight approx. 0.15 kg)		
Hours imprint	C72452-A94-B262 C72452-A94-B263 C72452-A94-B264 C72452-A94-B265 C72452-A94-B266	
For 10 mm/h		
20 mm/h		
60 mm/h		
120 mm/h		
Without		
Price per pack when ordering		
20		
60		
100		

Order No.	Price
Replacement parts	
Take-up spool for	
7ND3521	C72301-A20-B110
7ND3560	C79453-A3068-B9
7ND3590	C79301-A3000-B4
Recording unit for fanfold paper für 7ND3521	C72301-A20-A6
Recording unit for rolls für 7ND3590	C79301-A3000-A2
Recording unit for rolls or fanfold paper for 7ND3521	C72301-A20-A7
Lithium battery , 3 V	W79084-L1004-B1
Conversion parts	
Signal module, 3-channel (2 modules possible per recorder). The defined values are measuring limits	
DC U/I (DC voltage ± 10 V, direct current ± 20 mA) ^{1) 6)}	7ND9400-8AA
Signal module, 6-channel DC U/TC/RTD/R (1 module possible per recorder) DC voltage -100 mV, +600 mV Direct current -40 mA, +200 mA Resistance 0 Ω , 600 Ω Temperature via thermocouple or resistance thermometer ¹⁾	7ND9400-8AF
DC U/TC (2 modules possible per recorder, cannot be combined with 3-channel modules) DC voltage -10 mV, +1 V Direct current -4 mA, +20 mA Temperature via thermocouple ¹⁾	7ND9400-8AJ ³⁾
Serial interface 20-mA current loop, RS-232, RS-485 with enclosed zero modem cable	7ND9400-8BH ^{3) 5)}
Digital input/output with 6 inputs and 8 outputs	7ND9400-8BB
Measuring-point label without inscription For 7ND3521 For 7ND3560 For 7ND3590	C79165-A3029-B10 C79453-A3066-B119 C79165-A3029-B82
Measuring-point label with inscription For 7ND3521 For 7ND3560 For 7ND3590	C79165-A3029-B10-Z C79453-A3066-B119-Z C79165-A3029-B82-Z
Order code Specify in plain text: Desired text: . . . ²⁾	Y01

Available ex stock

- 1) Basic setting on delivery: all channels 20 mA.
- 2) Max. 29 characters per channel.
- 3) Can be used with firmware version 08 of recorder and later (can be called in STATUS menu). Firmware upgrading not possible.
- 4) When using several VARIOGRAPH hybrid recorders it is sometimes only necessary to have one remote control unit and one Manual. These are therefore not included in the delivery and must be ordered separately.
- 5) For use in recorders with firmware ≥ 07 to ≤ 08 on request.
- 6) See chapter 4 for further 3-channel signal modules.
- 7) Also available by downloading from the Internet (see page 5/10 bottom).

Hybrid recorders

VARIOGRAPH 7ND3521, 7ND3590, 7ND3560



Spare Parts, Accessories, Consumable Material for Older Design Recorders

4





4/2	Summary
4/2	Accessories for multipoint and line recorders SIREC 2010
4/2	Accessories for hybrid recorders VARIOGRAPH
4/2	Accessories for hybrid recorders PIEZOGRAPH
4/3	Accessories for servo recorders KOMPENSOGRAPH
4/5	Accessories for galvanometer recorders GALVANOGRAPH
4/6	Ordering data
4/6	Ink paper
4/7	Pens and replacement parts
4/8	Conversion parts for multipoint and line recorders
4/10	Ink paper for hybrid, multipoint and line recorders
4/11	Thermal papers for line recorders
4/12	Pen assemblies for hybrid, multipoint and line recorders
4/14	Other consumable material for multipoint and line recorders
4/15	Conversion parts for multipoint and line recorders
4/19	Ink paper for KOMPENSOGRAPH and GALVANOGRAPH
4/20	Pen assemblies for multipoint recorders
4/20	Ink
4/21	Further consumable material and conversion parts for servo multipoint recorders
4/23	Further consumable material and conversion parts
4/24	Measuring ranges for signal plug-ins, scales, rulers and memory chips (EPROM)

Spare Parts, Accessories, Consumable Material for Older Design Recorders SIREC 2010, VARIOGRAPH, PIEZOGRAPH

Summary



Accessories for SIREC 2010 multipoint and line recorders

		Size 144 x 144 Multipoint recorder Recorder code 7ND3020 Chart width 120 mm Recording width 100 mm		Size 144 x 144 Line recorder Recorder code 7ND3120 Chart width 120 mm Recording width 100 mm
Ink paper	Page 4/6			
Recording head	Page 4/7			
Fiber pen assemblies	Page 4/7			
Take-up spool	Page 4/7			
Recording unit	Page 4/7			
Lithium battery	Page 4/7			
Scales	Page 4/8			
Ruler	Page 4/8			
Measuring point labels	Page 4/9			

Accessories for VARIOGRAPH hybrid recorders

		Size 144 x 144 Hybrid recorder Recorder code 7ND3520 Chart width 120 mm Recording width 100 mm
Ink paper	Page 4/6	
Recording head	Page 4/7	
Take-up spool	Page 4/7	
Recording unit	Page 4/7	
Lithium battery	Page 4/7	
Signal module, 3-channel	Page 4/9	
Signal module, 6-channel	Page 4/9	
Measuring point labels	Page 4/9	

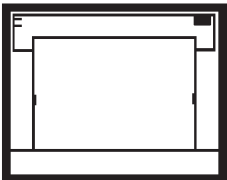
Accessories for PIEZOGRAPH hybrid recorders







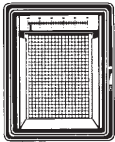
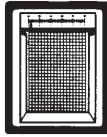

		Size 360 x 288 Hybrid recorder Recorder code 7ND2480 Chart width 270 mm Recording width 250 mm		Size 360 x 288 PIEZOGRAPH 2/3 hybrid recorder Recorder code 7ND2482 Chart width 270 mm Recording width 250 mm
Ink paper	Page 4/10		Page 4/6	
Ink reservoir	Page 4/12		Page 4/7	
Cleaning set	Page 4/12		Page 4/7	
Ink drip assembly			Page 4/7	
Take-up spool	Page 4/21		Page 4/7	
Lithium battery			Page 4/7	
Channel plug-in	Page 4/21			
Signal plug-in	Page 4/21			
Shunt	Page 4/21			
Limit monitor	Page 4/21		Page 4/9	
Interfaces			Page 4/9	
Memory modules	Page 4/21			
Memory unit			Page 4/21	

Spare Parts, Accessories, Consumable Material for Older Design Recorders

KOMPENSOGRAPH

Summary













Accessories for KOMPENSOGRAPH servo recorders

		Size 392 x 474 Multipoint and line recorders Recorder code K42, K77 Chart width 270 mm Recording width 250 mm					Size 398 x 480 Multipoint and line recorders Recorder code K155 Chart width 270 mm Recording width 250 mm			
Ink rollers for multipoint recorders	Page 4/20									
Ink and recording capillaries for line recorders	Page 4/20									
Size										
	288 x 288	192 x 288	192 x 288	192 x 240	288 x 288	288 x 240	192 x 288	192 x 240		
	Multipoint and line recorders				Line recorders		Multipoint and line recorders			
Recorder code	M2, M73810, 7ND1160, M73812, 7ND1060	M4, K164, M73814, M73816, 7ND1040, 7ND1140	M73916, M73760, 7ND1141, 7ND1142	M73632, M73634	7ND2160 7ND2161 7ND2162 7ND2163	7ND2150 7ND2151 7ND2152 7ND2153	7ND2042 7ND2043 7ND2140 7ND2141 7ND2142 7ND2143	7ND2032 7ND2033 7ND2130 7ND2131 7ND2132 7ND2133		
Chart width	230 mm	140 mm	140 mm	140 mm	230 mm	230 mm	140 mm	140 mm		
Recording width	210 mm	120 mm	120 mm	120 mm	210 mm	210 mm	120 mm	120 mm		
Ink paper	Page 4/19 C72452-A98-...	Page 4/19 C72452-A96-B9								
Ink roller drums for multipoint recorders	Page 4/20 C70301-A531-...				Page 4/12 (printing head)					
Ink for line recorders	Page 4/20									
Pens for line recorders	Page 4/21									
Fiber pen assemblies	Page 4/13									
Thermal styluses	Page 4/13									
Wipers: For potentiometers For limit contacts	Page 4/23 C70301-A531-B285 C70301-A531-B290			Page 4/23						
Scale cable	Page 4/22 C70301-A532- B42	Page 4/23								Page 4/14
Ink hose	Page 4/23									
Take-up spool	Pages 4/23									Page 4/14
Signal plug-in	Page 4/23 7ND9111-Z				Page 4/17					
Amplifier, inverter	Page 4/23									
Shunt for current measurement	Page 4/21 7ND9132-8AA						Page 4/17			
Resistor R_{CU}	Page 4/23 C74005-A212-A1				Page 4/23 C74005-A212-A1					
Scale plate	Pages 4/22 and 4/23									
Ruler	Page 4/22 7ND9260, 7ND9270-Z				Page 4/16					
Meas. point label	Page 4/18									
Mounting set for limit contacts	Page 4/18									
Mounting set for marking system	Page 4/18									
Blowball	Page 4/23									

KOMPENSOGRAPH 144 x 144, 96 x 144 and 72 x 144: Page 4/4

Spare Parts, Accessories, Consumable Material for Older Design Recorders KOMPENSOGRAPH

Summary

								
Size	144 x 144	144 x 144	144 x 144	144 x 144	144 x 144	96 x 144	96 x 144	72 x 144
Recorder code	M73910	M73911 7ND2020 7ND2021	K203	M73950 7ND1123 7ND2121 7ND2123	M742 M936 7ND1122 M73938 7ND1120 M73940 7ND1121	M73948 7ND1010	M73949 7ND1110	M73950 7ND1100 7ND2100 7ND2101
Chart width	120 mm	120 mm	110 mm	110 mm	120 mm	120 mm	120 mm	110 mm
Recording width	100 mm	100 mm	100 mm	100 mm	100 mm	100 mm	100 mm	100 mm
Ink paper	Page 4/19	Page 4/10 C72452-A94- B8 to B12	Page 4/10 ¹⁾		Page 4/10 C72452-A94- B8 to B12			Page 4/19 and Page 4/10 ¹⁾
Printing head and ink pad carrier for multipoint recorders	Page 4/20	Page 4/12 C72453-A320- -B117 u. -B221				Page 4/20		
Ink for line recorders			Page 4/20 and Page 4/12 ¹⁾					Page 4/12 ¹⁾
Fiber pens			Page 4/13 ¹⁾			Page 4/21		P. 4/13 ¹⁾
Wiper for potentiometer	Page 4/22							
Scale cable			Page 4/14 ¹⁾					P. 4/14 ¹⁾
Measuring point selector	Page 4/14, C74315-A66-A4							
Take-up spool	Page 4/22		Page 4/14 ¹⁾					P. 4/14 ¹⁾
Signal plug-in								
Shunt for current measurement	Page 4/23 7ND9132-8AA							
Resistor R_{CU}	Page 4/23, C74005-A212-A1							
Scale plate			Page 4/16 ¹⁾					P. 4/16 ¹⁾
Ruler	Page 4/16: 7ND9262, 7ND9272-Z		Page 4/16: 7ND9262, 7ND9272-Z		Page 4/16: 7ND9262, 7ND9272-Z		Page 4/16 7ND9272-Z	
Size								
Recorder code	144 x 144 Multipoint recorder		144 x 144 Line recorder		144 x 144		144 x 144	
Chart width	7ND2022 7ND2023		7ND2125		7ND2124		7ND2122	
Recording width	120 mm 100 mm		120 mm 100 mm		120 mm 100 mm		120 mm 100 mm	
Ink paper	Pages 4/10 and 11				Page 4/10			
Thermal paper					Page 4/11			
Printing head	Page 4/12							
Fiber pen					Page 4/13			
Thermal stylus					Page 4/13			
Scale cable	Page 4/14				Page 4/14			
Meas. point selector	Page 4/14							
Take-up spool	Page 4/14				Page 4/14			
Signal plug-in	Page 4/17 ²⁾				Page 4/17			
Shunt for current measurement	Page 4/17							
Scale plate	Page 4/16							
Ruler	Page 4/16							
Thermal manifold					Page 4/17			
Measuring point label	Page 4/18							

¹⁾ Only for 7ND21..













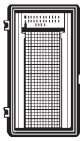



²⁾ Only for 7ND2023.

Spare Parts, Accessories, Consumable Material for Older Design Recorders

GALVANOGRAPH

Summary

Accessories for GALVANOGRAPH galvanometer recorders

										
Size	21 K	12 K	12 L, NUMO	SPV	288 x 240 288 x 288	192 x 240 192 x 288	192 x 240 192 x 288			
Recorder code	T22, T25	T20, T24, T26, T27	T3, T4, T21	F10 to F13	T7, T28, T35	F20 to F31 F32 to F43	T9, T23, T29			
Chart width	230 mm	140 mm	140 mm	140 mm	230 mm	140 mm	140 mm			
Recording width	210 mm	120 mm	120 mm	120 mm	210 mm	120 mm	120 mm			
Ink paper	Page 4/19									
Ribbons for multipoint recorders				Page 4/20		Page 4/20				
Ink pens. Recording capillaries and recording electrodes for line recorders	Page 4/20				Page 4/20		Page 4/20			
										
Size	288 x 288	288 x 240	192 x 288	192 x 240	192 x 288	192 x 240	144 x 144	144 x 144	144 x 144	96 x 96
Recorder code	T43, M02194, 7ND1360	T42, M02190, 7ND1350	M734, 7ND1240, M73260 to M73266	M734, 7ND1230, M73250	T38, M02192, 7ND1340	T40, M02188, 7ND1330	T8, T39 M02186	7ND2320 7ND2321 7ND2322 7ND2323 7ND2324	7ND1220	7ND2270 7ND2271
Chart width	230 mm	230 mm	140 mm	140 mm	140 mm	110 mm	110 mm	120 mm	120 mm	70 mm
Recording width	210 mm	210 mm	120 mm	120 mm	120 mm	100 mm	100 mm	100 mm	100 mm	60 mm
Ink paper	Page 4/19					Page 4/19	Page 4/10 ⁵⁾	Page 4/10 C72452- -A94-B8 to - B12 + -B262 to -B266 Page 4/11	Page 4/10	Page 4/10
Thermal paper							Page 4/11 ³⁾			
Ribbons for multipoint recorders			Page 4/20					Page 4/20	Page 4/12	
Ink for line recorders	Page 4/20					Page 4/20	Page 4/12			
Thermal stylus							Page 4/13 ²⁾			
Take-up spool							Page 4/14			
Scale plate							Page 4/16			
Ruler									Page 4/16	
Signal plug-in							Page 4/17 ⁴⁾			
Oil damping insert							Page 4/18 ¹⁾			
Measuring point label							Page 4/18			

1) Only for 7ND2320, 7ND2321 and 7ND2324. 2) Not for 7ND2323 and 7ND2324. 3) Not for 7ND2323 and 7ND2324. 4) Only for 7ND2320 and 7ND2321. 5) Only for 7ND2320 and 7ND2324.

Spare Parts, Accessories, Consumable Material for Older Design Recorders

Ink paper



Ordering data	Recording width	Divisions (linear)	Hours print	For recorder Order No.	144 x 144			360 x 288	Price per roll/fanfold pack for following quantity			
					7ND3020	7ND3120	7ND3520	7ND2482	10	20	60	100

Chart roll

Ink paper	Recording width	Divisions (linear)	Hours print	For recorder	7ND3020	7ND3120	7ND3520	7ND2482	10	20	60	100
120 mm wide Approx. 31 m long Approx. weight 0.15 kg	100 mm	50	For 10 mm/h 20 mm/h 60 mm/h 120 mm/h Without	C72452-A94-B208 C72452-A94-B209 C72452-A94-B210 C72452-A94-B211 C72452-A94-B212	- - - - ◆	◆ ◆ ◆ ◆ ◆	- - - - ◆	- - - - -	-	-	-	-
270 mm wide Brilliant Standard Approx. 33 m long Approx. weight 0.55 kg	250 mm	Without	Without	7ND2482-8UA 7ND2482-8UC	- -	- -	- -	◆ ◆	-	-	-	-

4

Fanfold chart

Ink paper	Recording width	Divisions (linear)	Hours print	For recorder	7ND3020	7ND3120	7ND3520	7ND2482	10	20	60	100
120 mm wide Approx. 16 m long Approx. weight 0.1 kg	100 mm	50	For 10 mm/h 20 mm/h 60 mm/h 120 mm/h Without	C72452-A94-B262 C72452-A94-B263 C72452-A94-B264 C72452-A94-B265 C72452-A94-B266	- - - - ◆	◆ ◆ ◆ ◆ ◆	- - - - ◆	- - - - -	-	-	-	-
270 mm wide Fanfold "Standard" Approx. 33 m long Approx. weight 0.55 kg	250 mm	Without	Without	7ND2482-8UD	-	-	-	◆	-	-	-	-

Available ex stock.

Minimum ordering quantity 20 rolls/fanfold packs, or 10 rolls/fanfold packs for 7ND2482.

Price for larger quantities than those listed on request.

Other range divisions, additional text and numbers on request.

Spare Parts, Accessories, Consumable Material for Older Design Recorders

Pens and replacement parts



Fig. 4/1 Recording head with 6 fiber pens for SIREC 2010 multipoint recorder 7ND3020 and VARIOGRAPH hybrid recorder 7ND3520

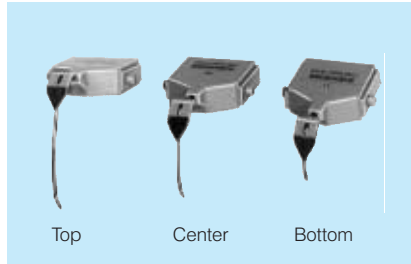

Fig. 4/2 Fiber pen assemblies for SIREC 2010 line recorder 7ND3120

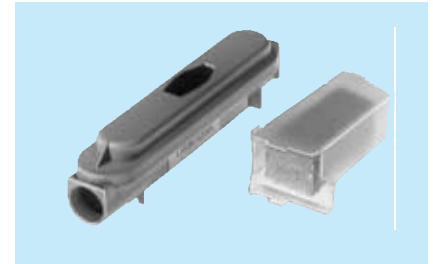

Fig. 4/3 Disposable ink reservoir for PIEZOGRAPH 7ND2482 with ink drip assembly

Ordering data	For recorder	144 x 144			360 x 288	Price
		7ND3020	7ND3120	7ND3520	7ND2482	
	Order No.					

Pen assemblies

Recording head (6 colors)		7ND9001-8FB		◆	-	◆	-	
Violet, red, black, green, blue and brown								
Fiber pen assembly		7ND9001-8AG		-	◆	-	-	
Recording width 100 mm per channel								
Channel assignment		Location	Color					
		Top	Green					
		Center	Blue		◆	-	-	
		Center	Red		◆	-	-	
		Bottom	Red		◆	-	-	
		Bottom	Blue		◆	-	-	
Disposable ink reservoir , contents 7 cm ³ (max. storage period 18 months) ¹⁾		Magenta	7ND2482-8TA	-	-	-	◆	
Minimum ordering quantity: 4 reservoirs (any combination of colors)		Cyan	7ND2482-8TB	-	-	-	◆	
		Yellow	7ND2482-8TC	-	-	-	◆	
		Black	7ND2482-8TD	-	-	-	◆	
Disposable ink reservoir set , content 7 cm ³ , magenta, cyan, yellow and 2 x black			7ND2482-8TE	-	-	-	◆	
Cleaning set for the piezo recording head			7ND2482-8VD	-	-	-	◆	
Ink drip assembly			7ND2482-8WB	-	-	-	◆	
Minimum ordering quantity 5 assemblies								

Replacement parts

Take-up spool	With rubber tongues (Fig. 4/4)	C72301-A20-B110	◆	◆	◆	-	
	With clamping sleeve (Fig. 4/5)	C79453-A3033-B203	-	-	-	◆	
Recording unit	For fanfold paper	C72301-A20-A6	-	-	◆	-	
	For chart roll or fanfold	C72301-A20-A7	-	-	◆	-	
Lithium battery	3 V	C72301-A20-A16	◆	◆	-	-	
	3 V	C72301-A20-A17	◆	◆	-	-	
Lithium battery	3.4 V	W79084-L1004-B1	-	-	◆	-	
		W79084-L1002-B1	◆	-	-	-	
		W79084-U1001-B2	-	-	-	◆	

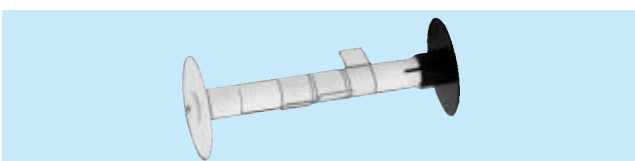

Fig. 4/4 Take-up spool with rubber tongues



Fig. 4/5 Take-up spool with clamping sleeve

¹⁾ Replacement of reservoir when in use: after max. 6 months.

Spare Parts, Accessories, Consumable Material for Older Design Recorders

Conversion parts for multipoint and line recorders

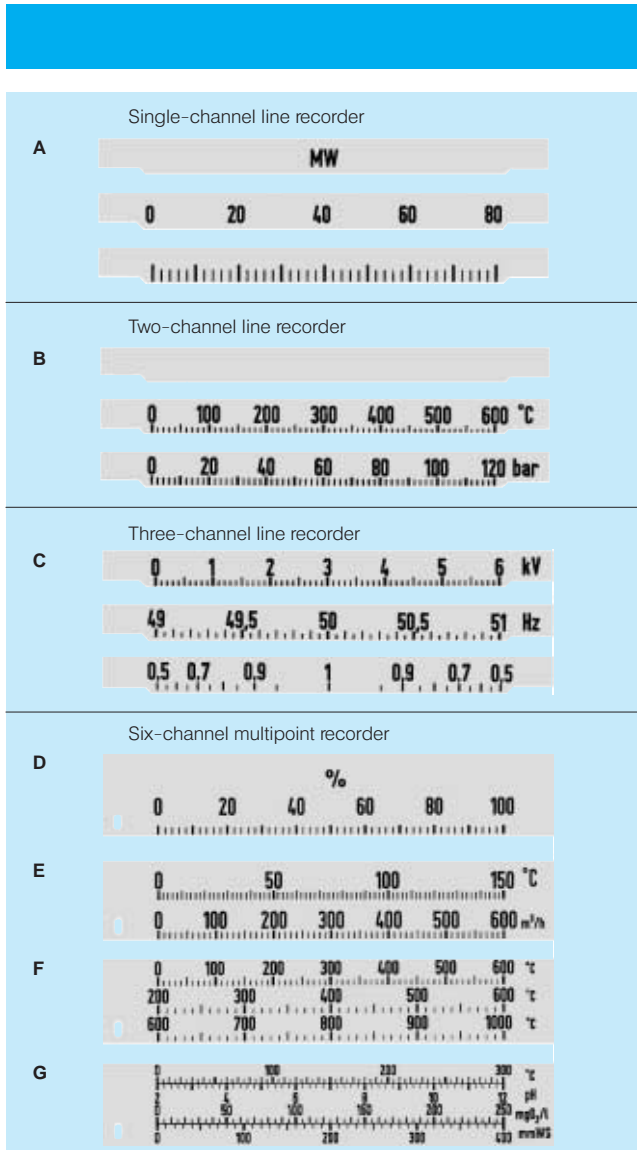

Fig. 4/6 Scale versions for line and multipoint recorders

Ordering data		For recorder		Price
		144 x 144	144 x 144	
		7ND3020	7ND3120	
		Order No.		
Scales				
Design and arrangement of scale plates	Number of scales			
-	Without 4)	7ND9300-8RA 7ND9300-8QA 1)	-	♦
A	One 2)	7ND9300-8RB-Z	-	♦
B or C 3)	One	7ND9300-8RC-Z	-	♦
D	One	7ND9300-8QB-Z 1)	♦	-
E	Two	7ND9300-8QC-Z 1)	♦	-
F	Three	7ND9300-8QD-Z 1)	♦	-
G	Four	7ND9300-8QE-Z 1)	♦	-
Ruler				
Without scale		7ND9262	♦	♦
With one scale		7ND9272-Z	♦	♦
Specify in addition for the Order Nos. identified by "-Z": Recording range(s) and scale(s) according to plain text		...		

- 1) A scale plate printed with two, three or four scales is required for each multipoint recorder (Fig. 4/6: D, E, F or G); sequence of scale plates from 1 at bottom to 4 at top according to sequence of Order codes 1 to 4.
- 2) One scale plate each for scale, measured variable and unit.
- 3) One scale plate required for each channel.
- 4) Start and end are marked.

Spare Parts, Accessories, Consumable Material for Older Design Recorders

Conversion parts

Ordering data	For recorder Order No.	144 x 144				288 x 144	288 x 288	360 x 288	Price
		7ND3020	7ND3120	7ND3520	7ND3521	7ND3590	7ND3560	7ND2482	
Signal module, three-channel (2 modules required per recorder)									
DC U/I DC voltage Direct current	Measuring limits ± 10 V ± 20 mA ³⁾	7ND9400-8AA	-	-	◆	-	-	-	
DC voltage Direct current	± 30 V ± 50 mA ⁴⁾	7ND9400-8AB ^{1) 11)}	-	-	-	◆	◆	-	
DC U/TC DC voltage Temperature via thermocouple	-10 mV, + 60 mV	7ND9400-8AC ^{1) 11)}	-	-	-	◆	◆	-	
Signal module, six-channel • Not intrinsically-safe ³⁾	DC U/TC/RTD/R	7ND9400-8AF ¹⁾	-	-	◆	-	-	-	
Measuring point label without inscription For SIREC 2010 line recorder For SIREC 2010 multipoint recorder For VARIOGRAPH hybrid recorder		C79165-A3029-B11 C79165-A3029-B12 C79165-A3029-B10	-	◆	-	-	-	-	
Measuring point label with inscription For SIREC 2010 line recorder For SIREC 2010 multipoint recorder For VARIOGRAPH hybrid recorder		C79165-A3029-B11-Z C79165-A3029-B12-Z C79165-A3029-B10-Z	-	◆	-	-	-	-	
Order code Specify in plain text: Desired text: . . . ⁷⁾		Y01	◆	◆	◆	-	-	-	
Limit monitor 2 alarm outputs per channel, selectable as maximum or minimum limits	32 outputs 64 outputs	7ND2482-8PA 7ND2482-8PB	-	-	-	-	-	◆	
Interface , basic basic Always required 1 x, in addition:		7ND2482-8NY ⁸⁾ 7ND2482-8NX ⁹⁾	-	-	-	-	-	◆	
Interface , IEC or/and Interface , serial		7ND2482-8NC 7ND2482-8NB	-	-	-	-	-	◆	

Available ex stock.

¹⁾ Can be used with firmware version 04 and later of VARIOGRAPH hybrid recorder. Upgrading of firmware on request. The firmware version can be called in the STATUS menu of the recorder.
²⁾ Can be used with firmware version 06 and later of VARIOGRAPH hybrid recorder. Upgrading of firmware on request. The firmware version can be called in the STATUS menu of the recorder.
³⁾ Basic setting on delivery: all channels 20 mA.
⁴⁾ Basic setting on delivery: all channels 50 mA.
⁵⁾ With resistance measurement in potentiometer circuit: max. 180 Ω can be set.

⁶⁾ Basic setting on delivery: all channels 100 V.
⁷⁾ Max. number of places for inscription: see Ordering data of associated recorder.
⁸⁾ Can be used up to firmware version < 10 of PIEZOGRAPH hybrid recorder.
⁹⁾ Can be used with firmware version ≥ 10/10/10 of PIEZOGRAPH hybrid recorder.
¹⁰⁾ With intrinsically-safe: -4 mA, +20 mA.
¹¹⁾ Only available as spare part. Without CE-symbol.

Spare Parts, Accessories, Consumable Material for Older Design Recorders

Ink paper for hybrid, multipoint and line recorders

Chart rolls

Ordering data	Recording width	Divisions (linear)	Hours print	For recorder	96 x 96	72 x 144	144 x 144						360 x 288				Price per roll for following quantity			
					7ND2270, 7ND2271	7ND2100, 7ND2101	7ND2022, 7ND2023	7ND2122	7ND2121, 7ND2123	7ND2124	7ND2125	7ND2320 (M73152)	7ND2324	7ND2480	10	20	60	100		
Ink paper				Order No.																
110 mm wide Approx. 16 m long Approx. weight 0.07 kg	100 mm	50	For 20 mm/h 60 mm/h Without	C72452-A92-B62 C72452-A92-B63 C72452-A92-B61	-	◆	-	-	◆	-	-	-	-	-	-	-	-	-	-	
120 mm wide Approx. 16 m long Approx. weight 0.1 kg	100 mm	50	For 10 mm/h 20 mm/h 60 mm/h 120 mm/h Without	C72452-A94-B8 C72452-A94-B9 C72452-A94-B10 C72452-A94-B11 C72452-A94-B12	-	-	◆	◆	-	◆	◆	◆	◆	-	-	-	-	-	-	
Approx. 31 m long Approx. weight 0.15 kg	100 mm	50	For 10 mm/h 20 mm/h 60 mm/h 120 mm/h Without	C72452-A94-B208 C72452-A94-B209 C72452-A94-B210 C72452-A94-B211 C72452-A94-B212	-	-	◆	-	-	◆	-	-	-	-	-	-	-	-		
270 mm wide Approx. 33 m long Approx. weight 0.55 kg	250 mm	Without	Without	C72452-A110-B1	-	-	-	-	-	-	-	-	-	◆	-	-	-	-		

Minimum ordering quantity 20 rolls, or 10 rolls for 7ND2480. Price for larger quantities than those listed on request. Other range divisions, additional text and numbers on request.

Spare Parts, Accessories, Consumable Material for Older Design Recorders

Ink paper for multipoint and line recorders, thermal papers for line recorders

Ink paper for multipoint and line recorders

Fanfold paper

Ordering data	Recording width	Divisions (linear)	Hours print	For recorder		Price per fanfold pack for following quantity		
				Order No.	144 x 144	20	60	100
Ink paper					7ND2022 7ND2023 7ND2125			
120 mm wide Approx. 16 m long Approx. weight 0.1 kg	100 mm	50	For 10 mm/h 20 mm/h 60 mm/h 120 mm/h Without	C72452-A94-B262 C72452-A94-B263 C72452-A94-B264 C72452-A94-B265 C72452-A94-B266	◆ ◆ ◆ ◆ ◆			

Thermal paper for line recorders

Chart rolls

Ordering data	Recording width	Divisions (linear)	Hours print	For recorder			Price per roll for following quantity		
				Order No.	144 x 144	7ND2125 7ND2320/21 (M73152) 7ND2322 (M73172)	20	60	100
Thermal paper									
120 mm wide Approx. 16 m long Approx. weight 0.1 kg	100 mm	50	For 20 mm/h Without	C72452-A94-B159 C72452-A94-B162	◆ ◆ - ◆ ◆ -				
		12	Without	C72452-A94-B181	- - ◆				

Spare Parts, Accessories, Consumable Material for Older Design Recorders

Pen assemblies for hybrid, multipoint and line recorders



Fig. 4/7 Ribbon for multipoint recorder



Fig. 4/8 Printing head with six fiber pens

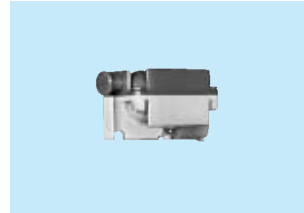

Fig. 4/9 Ink reservoir for hybrid recorder



Fig. 4/10 Ink, 50 cm³ bottle

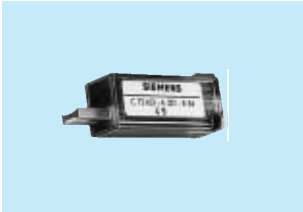

Fig. 4/11 Disposable ink reservoir 4 cm³

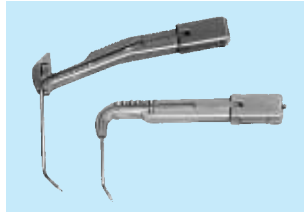

Fig. 4/12 Upper and lower channel pens

4

Ordering data			For recorder		72 x 144	96 x 96	144 x 144		192 x 240	192 x 288	360 x 288	Price
			Order No.	7ND2100 7ND2101	7ND2270 7ND2271	7ND2022 7ND2023	7ND2121/23 7ND2320 (M73152) 7ND2324	7ND2032 7ND2033	7ND2042 7ND2043	7ND2480		
Ribbons												
For single-channel recorders	6, blue		7ND9018-8AA	-	♦	-	-	-	-	-	-	
For two-channel recorders	3, blue and red (2 colors each)		7ND9018-8AB	-	♦	-	-	-	-	-	-	
For six-channel recorders	3, black, red, green, blue, brown and violet (6 colors each)		7ND9018-8AC	-	♦	-	-	-	-	-	-	
Printing head (6 colors) DIN 16 235-A-h-6 violet, red, black, green, blue and brown			C72453-A320-B117	-	-	♦	-	-	♦	♦	-	
Ink reservoir set (stock life max. 18 months), consisting of ink reservoirs in magenta, cyan, yellow and black as well as a tampon with holder (replacement of reservoir in recorder: max. 6 mon.)			C79453-A3031-D50	-	-	-	-	-	-	-	♦	
Cleaning set for piezo recording head, not for "A ink", comprising 1 bottle of cleaning liquid (40 cm ³) and 1 brush			C79453-A3031-D33	-	-	-	-	-	-	-	♦	
Cleaning set as above, but for recording heads identified "A ink"			7ND2482-8VD	-	-	-	-	-	-	-	♦	
Ink	Bottle 50 cm ³	Blue	C72452-Z725-C30	♦	-	-	♦	-	-	-	-	
		Red	C72452-Z725-C32	♦	-	-	♦	-	-	-	-	
		Green	C72452-Z725-C31	♦	-	-	♦	-	-	-	-	
	Bottle 500 cm ³	Blue ¹⁾	C72452-Z725-C28	-	-	-	-	♦	-	-	-	
		Red ¹⁾	C72452-Z725-C27	-	-	-	-	♦	-	-	-	
		Grn. ¹⁾	C72452-Z725-C29	-	-	-	-	♦	-	-	-	
	Disposable ink reservoir ²⁾ 4 cm ³	Blue ¹⁾	7ND9050-0GB	-	-	-	-	♦	-	-	-	
		Red ¹⁾	7ND9050-0PC	-	-	-	-	♦	-	-	-	
		Grn. ¹⁾	7ND9050-0QD	-	-	-	-	♦	-	-	-	
	2 ink bags ¹⁾	Red	C72453-A321-B83	-	-	-	-	♦	♦	-	-	
		Blue	C72453-A321-B84	-	-	-	-	♦	♦	-	-	
		Red	C72453-Z725-H1	-	-	-	-	♦	-	-	-	
Blue		C72453-Z725-H2	-	-	-	-	♦	-	-	-		

1) Before ordering, check whether the recorder 7ND2320 has an ink bag, refillable reservoir or disposable reservoir.

2) Applies to recorder 7ND2320 only from serial No. M 10-785 onwards.

Spare Parts, Accessories, Consumable Material for Older Design Recorders

Pen assemblies for line recorders

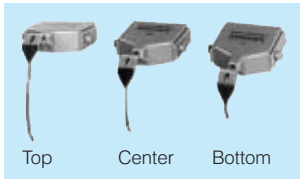

Fig. 4/13
Fiber pens 7ND9001-8AG, -8AD/AE, -8AA/AB and thermal styluses 7ND9001-8CA

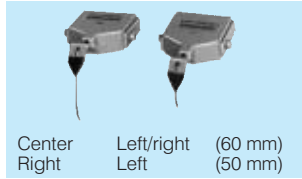

Fig. 4/14
Fiber pens 7ND9001-8AK, -8AA and thermal styluses 7ND9001-8CA

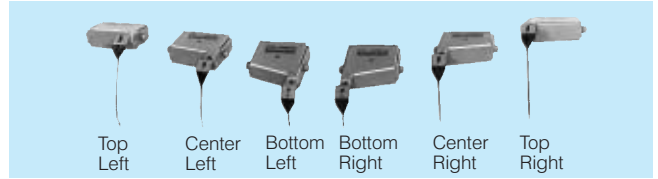

Fig. 4/15 Fiber pens 7ND9001-8AU, -8AN, -8AR, -8BA

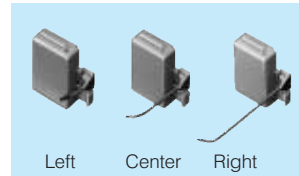

Fig. 4/16 Fiber pens 7ND9001-8BL/BK, -8BP/BN, -8BR



Fig. 4/17 Thermal styluses C72453-A321-B162, -B160

Ordering data			For recorder	72x 144							144 x 144				192 x 240				288 x 240				Price
Fiber pen assembly for recording on ink paper				7ND210001	7ND2121	7ND2122	7ND2123	7ND2124	7ND2125	7ND2125/22	7ND2130 7ND2131	7ND2132 7ND2133	192 x 288		288 x 288		7ND2150 7ND2151	7ND2152 7ND2153					
Channel assignment	Location	Color	Order No.	100	100	100	100	100	100	100	120	50	120	50	210	100	60	210	100	60			
	Left	Blue Red	7ND9001-8BL 7ND9001-8BK	◆	◆	-	◆	-	-	-	-	-	-	-	-	-	-	-	-	-	-		
	Center	Red Blue	7ND9001-8BP 7ND9001-8BN	◆	◆	-	◆	-	-	-	-	-	-	-	-	-	-	-	-	-	-		
	Right	Green	7ND9001-8BR	◆	◆	-	◆	-	-	-	-	-	-	-	-	-	-	-	-	-	-		
	Top	Green	7ND9001-8AG	-	-	◆	-	◆	-	◆	-	◆	-	◆	-	◆	-	◆	-	◆	-		
	Center	Blue Red	7ND9001-8AD 7ND9001-8AE	-	-	◆	-	◆	◆	-	◆	-	◆	-	◆	-	◆	-	◆	-	◆	-	
	Bottom	Red Blue	7ND9001-8AA 7ND9001-8AB	-	-	◆	-	◆	◆	-	◆	-	◆	-	◆	-	◆	-	◆	-	◆	-	
	Cent. left right	Blue Blue	7ND9001-8AU 7ND9001-8BA	-	-	-	-	-	-	-	-	-	-	-	-	◆	-	-	◆	-	-		
	Bot. left right	Red Red	7ND9001-8AN 7ND9001-8AR	-	-	-	-	-	-	-	-	-	-	-	-	◆	-	-	◆	-	-		
	Left Right	Red Red	7ND9001-8AA 7ND9001-8AK	-	-	-	-	-	-	-	-	◆	-	◆	-	-	-	-	-	-	-	-	
	Left/right Center	Red Red	7ND9001-8AA 7ND9001-8AK	-	-	-	-	-	-	-	-	-	-	-	-	-	◆	-	-	◆	-		
Thermal stylus for recording on thermal paper																							
Channel assignment			Location	Indicat. color																			
	Bottom	Red	7ND9001-8CA	-	-	-	-	◆	-	◆	-	-	-	-	◆	-	-	-	-	-	-		
	Left Right	Red Red	7ND9001-8CA 7ND9001-8CD	-	-	-	-	-	-	-	-	◆	-	-	-	-	-	-	-	-	-		
	Left/right	Red	7ND9001-8CA	-	-	-	-	-	-	-	-	-	-	-	-	◆	-	-	-	-	-		
	Top Bottom	Blue Red	C72453- -A321-B162 -A321-B160	-	-	-	-	-	◆	-	-	-	-	-	-	-	-	-	-	-	-		

Spare Parts, Accessories, Consumable Material for Older Design Recorders

Other consumable material for multipoint and line recorders

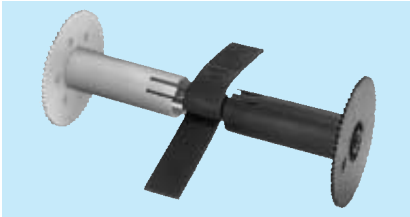

Fig. 4/18 Take-up spool with rubber tongues; for automatic chart take-up

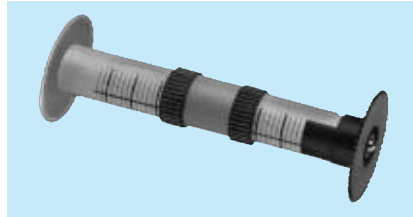

Fig. 4/19 Take-up spool with rubber rings; for automatic chart take-up

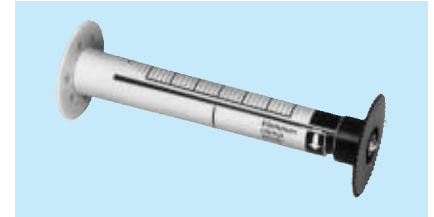

Fig. 4/20 Take-up spool with clamping sleeve

Ordering data	For recorder	72 x 144	144 x 144				192 x 240	192 x 288	288 x 240	288 x 288	Price			
		Order No.	7ND2100, 7ND2101	7ND2022	7ND2023	7ND2121, 7ND2123 7ND2122, 7ND2124 7ND2125	7ND2320 (M73152) 7ND2321, 7ND2322, 7ND2323 7ND2324	7ND2032	7ND2033	7ND2130, 7ND2131 7ND2132, 7ND2133		7ND2042	7ND2043	7ND2140, 7ND2141 7ND2142, 7ND2143
Take-up spool with rubber tongues	C72301-A20-B110 C72301-A20-B71 C72301-A20-B72	-	◆	◆	-	◆	-	◆	◆	◆	-	-	-	-
Take-up spool with rubber rings	C72301-A20-B53	-	-	-	◆	-	-	-	-	-	-	-	◆	◆
Take-up spool with clamping sleeve	C72301-A20-B13	-	-	-	-	◆	◆	◆	-	-	-	-	-	-
Mandrel (part pushed onto take-up spool)	C72301-A22-B8	◆	-	-	◆	-	-	-	-	-	-	-	-	-
Scale cable For channel 1 (white identification) For channel 2 (gray identification) For channel 3 (black identification)	C72453-A340-B6 C72453-A340-B7 C72453-A340-B8	◆	-	-	◆	-	-	-	-	-	-	-	-	-
For fiber pen recording For thermal stylus recording	C79453-A3011-B39 C79453-A3025-D83	-	-	-	-	◆	-	-	-	◆	◆	◆	◆	◆
	C79453-A3027-C72 C79453-A3027-C75	-	◆	◆	-	-	-	-	-	-	◆	◆	-	-
Servo unit	C72246-A144-A14 ³⁾ C72246-A144-A6 C72246-A144-A8 C72246-A144-A18	◆	-	-	◆	-	-	-	-	-	-	-	-	-
Servo unit , without motor	C72246-A144-A7 C72246-A144-A13	-	◆	-	-	-	-	-	◆	◆	-	-	-	-
Recording unit for chart roll	C72301-A22-A1 C72301-A22-A2 C72301-A20-A8 C72301-A20-A4	◆	-	-	◆	-	-	-	-	-	-	-	-	-
	C72301-A20-A10 C72301-A20-A12 C72301-A20-A11 C72301-A20-A13	-	-	-	-	-	-	-	◆	◆	◆	◆	-	-
Recording unit For fanfold paper For roll or fanfold paper	C72301-A20-A6 C72301-A20-A7	-	◆	◆	-	◆	-	-	-	-	-	-	-	-
Measuring point selector , Single-pole plug-in Two-pole	C74315-A66-A4 W79050-U1201-U106	-	◆	-	-	-	-	◆	-	-	◆	-	-	-
Ink reservoir , refillable	C72453-A315-B20 ¹⁾	-	-	-	-	◆	-	-	-	-	-	-	-	-
Ink hose for measuring system	C72246-A138-C73	-	-	-	-	◆	-	-	-	-	-	-	-	-
Holder for ink reservoir	C72453-A315-C24 ¹⁾ C72453-A315-B86 ²⁾	-	-	-	-	◆	-	◆	-	-	-	-	-	-
Plug for ink reservoir Channel 1 Channel 2	C72453-A315-B33 C72453-A315-B35	-	-	-	-	◆	-	◆	-	-	-	-	-	-
Tube	C72246-A138-C94	-	-	-	-	◆	-	◆	-	-	-	-	-	-
Blowball	C79453-A3028-B1	-	-	-	-	◆	-	◆	-	-	-	-	-	-
Lubricating oil Etsyntha Silber Bottle 1 cm ³	C72453-A320-B22	◆	◆	◆	◆	-	-	-	-	-	-	-	-	-
Flushing liquid Bottle 5 cm ³ Tank 4 cm ³	C72453-A315-B23 ¹⁾ C72453-A321-B88 ²⁾	-	-	-	-	◆	-	◆	-	-	-	-	-	-

1) Only applies to rec. 7ND2320 up to ser. No. M10-784. 2) Only applies to rec. 7ND2320 from ser. No. M10-785 onwards. 3) Not for 7ND2100 and 7ND2121.

Spare Parts, Accessories, Consumable Material for Older Design Recorders

Conversion parts for multipoint and line recorders

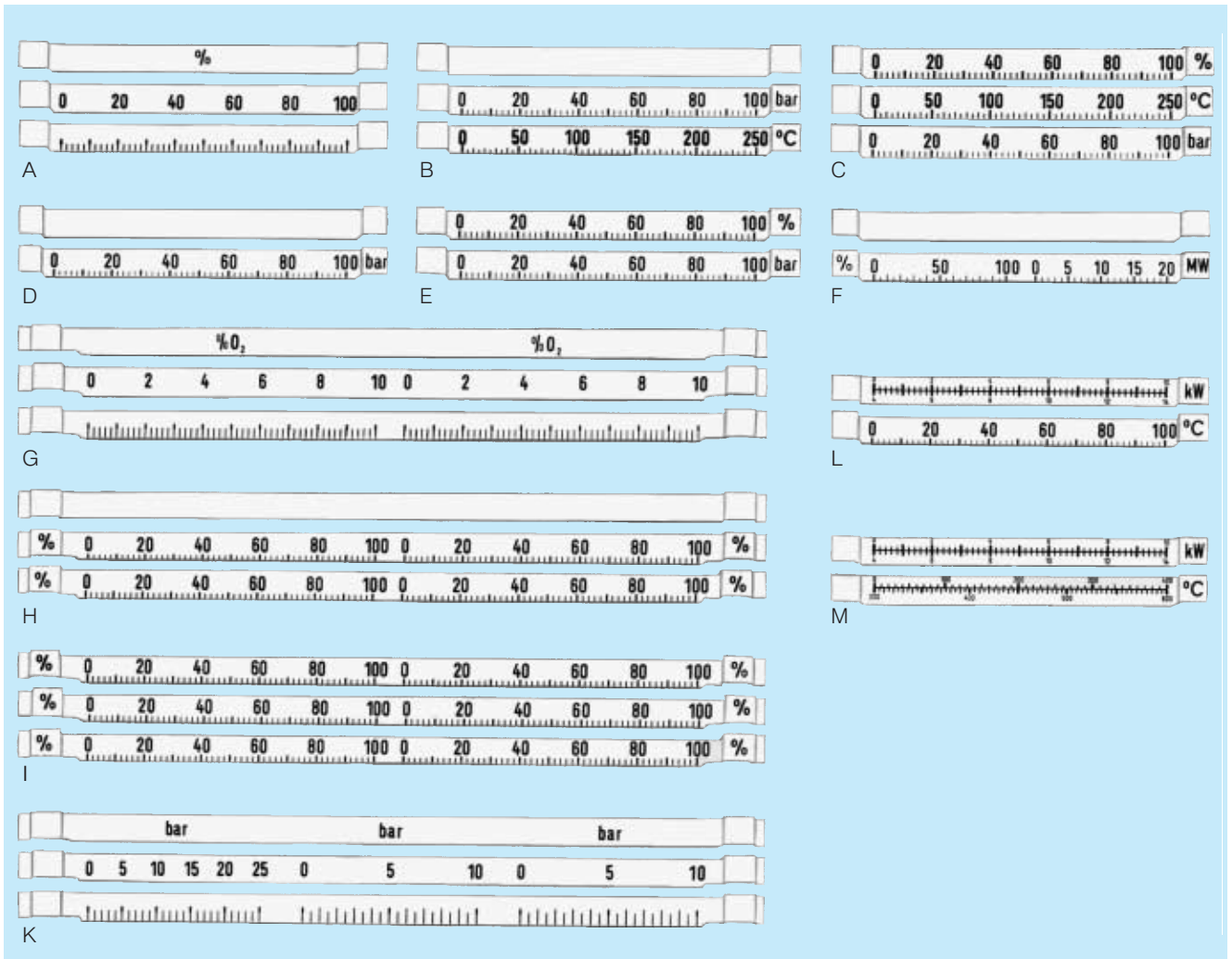

Fig. 4/21 Scale versions for flush-mounting recorders; design and arrangement of the scale plates (strips)

Spare Parts, Accessories, Consumable Material for Older Design Recorders

Conversion parts for multipoint and line recorders



Ordering data		For recorder	96 x 96	72 x 144	144 x 144		192 x 240	192 x 288	288 x 240		288 x 288		Price					
			7ND2270, 7ND2271	7ND2100, 7ND2101	7ND2022, 7ND2023	7ND2122	7ND2121, 7ND2123	7ND2124, 7ND2125	7ND2320, 7ND2324	7ND2032, 7ND2033	7ND2130 to 7ND2133	7ND2042, 7ND2043		7ND2140 to 7ND2143	7ND2150	7ND2151, 7ND2153	7ND2152	7ND2160
		Order No.																
Scale plate	Without scale	7ND9300-8HA	-	♦	-	-	-	-	-	-	-	-	-	-	-	-	-	-
	With one scale	7ND9300-8HB-Z	-	♦	-	-	♦	-	-	-	-	-	-	-	-	-	-	-
Design and arrangement of scale plates (strips) Fig. 4/21	Number of scales																	
-	Without	7ND9300-8FA ¹⁾ 7ND9300-8PA ¹⁾ 7ND9300-8NA	-	-	♦	♦	♦	♦	♦	-	♦	♦	-	-	-	-	-	-
A	One ²⁾	7ND9300-8FH-Z 7ND9300-8PH-Z 7ND9300-8NH-Z	-	-	-	♦	-	♦	-	-	♦	-	-	-	-	-	-	-
B or C	One	7ND9300-8FB-Z 7ND9300-8PB-Z ¹⁾ 7ND9300-8NB-Z	-	-	-	♦	-	♦	-	♦	♦	-	-	-	-	-	-	-
D or E	One	7ND9300-8FB-Z ¹⁾	-	-	♦	-	-	♦	-	-	-	-	-	-	-	-	-	-
G	Two adjacent ²⁾	7ND9300-8PJ-Z 7ND9300-8NJ-Z	-	-	-	-	-	-	♦	-	♦	-	-	-	-	-	-	-
F	Two adjacent	7ND9300-8FL-Z	-	-	-	-	-	♦	-	-	-	-	-	-	-	-	-	-
H or I		7ND9300-8NL-Z	-	-	-	-	-	-	-	-	-	♦	-	♦	-	-	-	♦
K	Three adjacent ²⁾	7ND9300-8NK-Z	-	-	-	-	-	-	-	-	-	♦	♦	♦	-	-	-	♦
L or M	Two above each other	7ND9300-8FC-Z ¹⁾ 7ND9300-8PC-Z ¹⁾	-	-	♦	-	-	-	-	-	♦	-	-	-	-	-	-	-
Specify in addition for the Order Nos. identified by "-Z": Order code(s) for the desired measuring range(s) (pages 4/24 to 4/27)		...	-	♦	♦	♦	♦	♦	♦	♦	♦	♦	♦	♦	♦	♦	♦	♦
Ruler without scale		7ND9262 7ND9261 7ND9260	-	♦	♦	♦	♦	♦	♦	-	-	-	-	-	-	-	-	-
Ruler with one scale		7ND9281-8AB-Z 7ND9272-Z 7ND9271-Z 7ND9270-Z	♦	-	-	-	-	-	-	-	-	-	-	-	-	-	-	-
With two adjacent scales, recording width per channel	45 mm	7ND9281-8AD-Z	-	-	-	-	-	♦	-	-	-	-	-	-	-	-	-	-
	50 mm	7ND9281-8AC-Z	-	-	-	-	-	-	♦	-	♦	-	-	-	-	-	-	-
	100 mm	7ND9281-8AF-Z	-	-	-	-	-	-	-	-	-	♦	♦	♦	-	-	-	♦
With three adjacent scales, recording width per channel	60 mm	7ND9281-8AE-Z	-	-	-	-	-	-	-	-	-	♦	♦	♦	-	-	-	♦
Specify in addition for the Order Nos. identified by "-Z": Order code(s) for the desired measuring range(s) (pages 4/24 to 4/27)		...	♦	♦	♦	♦	♦	♦	♦	♦	♦	♦	♦	♦	♦	♦	♦	♦

1) Two scale plates (for one or two scales each) are required for multipoint recorders (Fig. 22; D, E, L, M).
2) One scale plate (strip) each for scale, measured variable and unit.

Spare Parts, Accessories, Consumable Material for Older Design Recorders

Conversion parts for multipoint and line recorders

Ordering data	For recorder	144 x 144					192 x 240				192 x 288			288 x 240		288 x 288		Price
		7ND2022	7ND2023	7ND2122	7ND2124, 7ND2125	7ND2320, 7ND2321 (M73152)	7ND2032	7ND2033	7ND2130	7ND2131, 7ND2133	7ND2042	7ND2043	7ND2140	7ND2141, 7ND2143	7ND2150	7ND2151, 7ND2153	7ND2160	
Amplifier for signal ranges 0 to 20 mA, 4 to 20 mA	C79453-A3011-B51	-	-	◆	-	-	-	-	-	-	-	-	-	-	-	-	-	-
Signal plug-in (see example for ordering)	7ND9118-8L-Z ¹⁾ 7ND9118-8K-Z 7ND9121-Z 7ND9118-8J-Z	-	◆	-	-	-	-	◆	-	-	◆	-	-	-	-	-	-	
For current, voltage, thermoelectric voltage, resistance, power and frequency measurements		-	-	-	◆	-	-	-	-	-	-	-	-	-	-	-	-	
For current measurements		7ND9118-8G-Z	-	-	-	-	-	-	◆	-	-	-	◆	-	◆	-	◆	-
For voltage measurements 500 mV ≤ ΔU ≤ 40 V		7ND9118-8H-Z	-	-	-	-	-	-	-	◆	-	-	-	◆	-	-	◆	-
Specify in addition for the Order Nos. identified by "-Z": Order code for the desired measuring range (pages 4/24 to 4/27)	...	-	◆	-	◆	◆	-	◆	◆	◆	-	◆	◆	◆	◆	◆	◆	
Measuring point selector , plug-in Single-pole Two-pole	C74315-A66-A4 W79050-U1201-U106	◆	-	-	-	-	◆	-	-	-	◆	-	-	-	-	-	-	
Shunt , R _e = 25 Ω ± 0.1 % A shunt is required for each measuring point if a signal plug-in is used for current measurements.	7ND9132-8AB	◆	◆	-	-	-	◆	◆	-	-	◆	◆	-	-	-	-	-	

Example for ordering

Required:

Signal plug-in for voltage measurements;
for KOMPENSOGRAF 7ND2131;
signal range 0 to 500 mV,
measuring range 0 to 100 % linear

Order No. 7ND9118-8J-Z
Order code (page 4/26) H10

Complete Order No.: **7ND9118-8J-Z**
H10

¹⁾ Only one shunt (25 Ω) is required per measuring point with signal ranges for current measurements (0/4 to 20 mA).

Spare Parts, Accessories, Consumable Material for Older Design Recorders

Conversion parts for multipoint and line recorders

Ordering data	For recorder	72 x 144	144 x 144						192 x 240	192 x 288	192 x 240	288 x 288	Price						
		7ND2100, 7ND2101	7ND2022, 7ND2023	7ND2122	7ND2121, 7ND2123	7ND2124, 7ND2125	7ND2320/21 (M73152)	7ND2323	7ND2324	7ND2032, 7ND2033	7ND2130, 7ND2131	7ND2132, 7ND2133		7ND2042, 7ND2043	7ND2140, 7ND2141	7ND2142, 7ND2143	7ND2150, 7ND2151	7ND2152, 7ND2153	7ND2160, 7ND2161
Measuring point label without inscription For single-channel to three-channel recorders For single-channel to six-channel recorders For six-channel recorders For twelve-channel recorders Specify in addition for the Order Nos. identified by "-Z": Order code: Plain text: Number of channels: ... Recording width per channel: ... mm	C72453-A340-C123 C72453-A340-C124 C72165-A405-B43-Z C79165-A3010-B127-Z C79165-A3010-B129-Z C72165-A405-C299 C72165-A405-C320 C72165-A405-C310 Y02	◆	-	-	◆	-	-	-	-	-	-	-	-	-	-	-	-	-	-
Measuring point label with inscription For six-channel recorders For twelve-channel recorders Order code: Specify in plain text: Desired text: ...	C72165-A405-C299-Z C72165-A405-C320-Z C72165-A405-C310-Z Y01	-	◆	-	-	-	-	-	◆	-	-	◆	-	-	-	-	-	-	-
For single-channel to three-channel recorders For single-channel to six-channel recorders Order code: Specify in plain text: Desired text: ... Number of channels: ... Recording width per channel: ... mm	C72165-A405-B43-Z C72165-A3010-B127-Z C72165-A3010-B129-Z Y01 Y03	-	-	◆	-	◆	◆	-	◆	-	-	-	◆	◆	-	-	◆	◆	-
Mounting set for two electronic limit contacts Selectable as minimum or maximum contact	C79453-A3011-D67 C79453-A3025-D69	-	-	-	-	◆	-	-	-	-	-	-	-	-	-	-	-	-	-
Oil damping insert 6 s 15 s 30 s 60 s	C72246-A138-B60 C72246-A138-B61 C72246-A138-B62 C72246-A138-B63	-	-	-	-	-	◆	-	◆	-	-	-	-	-	-	-	-	-	-
Mounting set for electronic marking system For 1 channel ¹⁾ For up to 3 channels ²⁾	C79453-A3025-D70 C79453-A3025-D157	-	-	-	-	-	-	-	◆	-	-	◆	-	◆	-	◆	-	-	-



Fig. 4/22 Oil damping insert for GALVANOGRAPH line recorders 7ND2320, 7ND2321 and 7ND2324

1) One marking system can be used per channel.
 2) One marking system can be used per channel, only for 7ND2152.

Spare Parts, Accessories, Consumable Material for Older Design Recorders

Ink paper for KOMPENSOGRAPH and GALVANOGRAPH

Ordering data		Order No.	Price per roll for following quantity		
			20	60	100
For recorder	Designation				
Servo multipoint recorder: KOMPENSOGRAPH 288 x 288	Ink paper 230 mm wide Length Approx. 24 m Weight Approx. 0.25 kg Recording width 210 mm 100 linear divisions Hours print for 20 mm/h Without hours print 105 linear divisions Hours print for 20 mm/h	C72452-A98-B9 C72452-A98-B12 C72452-A98-B15			
Galvanometer line recorders: 288 x 240, 288 x 288 GALVANOGRAPH 7ND1350 (M02190) 7ND1360 (M02194) T7, T22, T25, T28, T35, T42, T43	Ink paper 230 mm wide Length Approx. 24 m Weight Approx. 0.25 kg Recording width 2 x 100 mm 50 linear divisions each Hours print for 20 mm/h Recording width 3 x 60 mm 20 linear divisions each Hours print for 20 mm/h	C72452-A98-B22 C72452-A98-B32			
Galvanometer line recorders: 192 x 240, 192 x 288 GALVANOGRAPH 7ND1330 (M02188) 7ND1340 (M02192) T3, T4, T9, T20, T21, T23, T24, T26, T27, T29, T38, T40 Galvanometer multipoint recorders: 192 x 240, 192 x 288 F10 to F13 F20 to F43 M734 Multipoint and line recorders: KOMPENSOGRAPH 192 x 240, 192 x 288 M4, K164 M73632, M73634, M73760, M73814, M73816, M73916 7ND1040, 7ND1140 to 7ND1142	Ink paper 140 mm wide Length Approx. 24 m Weight Approx. 0.15 kg Recording width 120 mm 50 linear divisions Hours print for 20 mm/h	C72452-A96-B9			
Multipoint recorders: KOMPENSOGRAPH 144 x 144 M73910	Ink paper 120 mm wide Length Approx. 16 m Weight Approx. 0.1 kg Recording width 100 mm 50 linear divisions Hours print for 20 mm/h	C72452-A94-B109			
Line recorders: KOMPENSOGRAPH 144 x 144 K203 GALVANOGRAPH 144 x 144 T8, T39 and M02186	Ink paper 110 mm wide Length Approx. 16 m Weight Approx. 0.08 kg Recording width 100 mm 50 linear divisions Hours print for 10 mm/h 20 mm/h Without hours print	C72452-A92-B8 C72452-A92-B9 C72452-A92-B12			

Minimum ordering quantity 20 rolls.
Price for larger quantities than those listed on request.
Other range divisions, additional text and numbers on request.

Spare Parts, Accessories, Consumable Material for Older Design Recorders

Pen assemblies for multipoint recorders, ink

Pen assemblies for multipoint recorders

Ordering data	Designation	Order No.	Price
For recorders KOMPENSOGRAPH 288 x 288 7ND1060 (M73812)	 Ink roller drum For six-channel and twelve-channel recorders Violet, red, black, brown, blue and green ink rollers, 1 each	C70301-A531-B302	
KOMPENSOGRAPH 144 x 144 M73910	Ink pad carrier Violet, red, black, green, blue and brown	C74453-A172-B29	
KOMPENSOGRAPH 96 x 144 M73948, 7ND1010	Six-color printing head Violet, red, black, green, blue and brown	M73948-X-A1	
GALVANOGRAPH 192 x 240, 192 x 288 M734 7ND1230 (M73250 to M73256) 7ND1240 (M73260 to M73266) F10 to F13, F20 to F43	Ribbons For single-channel recorders For two-channel recorders For three-channel recorders For six-channel recorders Violet, 6 off Violet and red, 3 each Violet, red and black, 2 each Violet, red, black, brown, blue and green, 1 each	C74301-A8-B53 C74301-A8-B54 C74301-A8-B55 C74301-A8-B56	
GALVANOGRAPH 144 x 144 7ND1220	Ribbons For single-channel recorders For six-channel recorders Violet, 6 off Violet, red, black, green, blue and brown, 3 each	7ND9058-0AB 7ND9058-0DB	

Ink

4



Ordering data	Designation	Order No.	Price
For recorders Line recorders: KOMPENSOGRAPH 192 x 288 M73760, M73916, 7ND1141 and 7ND1142 KOMPENSOGRAPH 192 x 240 M73632 and M73634 KOMPENSOGRAPH 144 x 144 K203, M742, M936, 7ND1120 to 7ND1122, M73938, M73940	Recording ink Plastic bottle 8 cm ³ Violet Red Green	C71452-A64-B1 C71452-A64-B2 C71452-A64-B3	
Multipoint and line recorders: KOMPENSOGRAPH 288 x 288 M2 KOMPENSOGRAPH 288 x 288 7ND1060 (M73812) ¹⁾ KOMPENSOGRAPH 192 x 288 M4, K164 Line recorders: KOMPENSOGRAPH 192 x 288 7ND1141 (M73916) 7ND1142 (M73760) KOMPENSOGRAPH 192 x 240 M73632 and M73634 KOMPENSOGRAPH 144 x 144 K203, M742, M936, M73938, M73940 and M73950, 7ND1120 to 7ND1123 KOMPENSOGRAPH 72 x 144 M73950, 7ND1100 GALVANOGRAPH 144 x 144 192 x 240, 192 x 288, 288 x 240, 288 x 288 7ND1330 (M02188), 7ND1340 (M02192), 7ND1350 (M02190), 7ND1360 (M02194) and M02186	Recording ink Bottle 50 cm ³ Violet Red Green Bottle 500 cm ³ Violet Red Green	C70429-A63-A8 C70429-A63-A7 C70429-A63-A9 C70429-A959-A8 C70429-A959-A7 C70429-A959-A9	

¹⁾ Only applies to marking system with recording capillary (older version).

Spare Parts, Accessories, Consumable Material for Older Design Recorders

Further consumable material and conversion parts for servo multipoint recorders

Pens, recording electrodes and fiber pen assemblies

Ordering data	Designation	Order No.	Price
For recorders			
Line recorders: GALVANOGRAPH 144 x 144, 192 x 240, 192 x 228, 288 x 240, 288 x 288 7ND1330 (M02188), 7ND1340 (M02192), 7ND1350 (M02190), 7ND1360 (M02194) and M02186	 Fiber pen Red Blue Violet Green Brown Black Holder for fiber pen	7ND9001-8DA 7ND9001-8DB 7ND9001-8DC 7ND9001-8DS 7ND9001-8DE 7ND9001-8DF 7ND9001-8DG	
Line recorders: KOMPENSOGRAPH 192 x 288, 288 x 288 M2, M4, M73810, M73814, 7ND1140 and 7ND1160	 Pen for measuring system	C70301-A531-B495	
Line recorders: KOMPENSOGRAPH 192 x 288, 288 x 288 M2, M4, M73810, M73814, 7ND1140 and 7ND1160 Multipoint recorders: KOMPENSOGRAPH 192 x 288 M4, M73816 and 7ND1040	Fiber pen assembly for marking system (only version with fiber pen assembly)	7ND9001-8FA	
Line recorders: KOMPENSOGRAPH 96 x 144 M73949, 7ND1110	Fiber pen assembly 6 pens, violet 6 pens, red Channel 1 Channel 2	M73949-X-A1 M73949-X-A2	

Further consumable material and conversion parts for hybrid recorders

Ordering data	Designation	Order No.	Price
For recorders			
Hybrid recorders: PIEZOGRAPH 360 x 288 7ND2480	Take-up spool Channel plug-in for 8 channels Signal plug-in For current measurements 1) For voltage measurements For voltage and thermoelectric voltage measurements $5 \text{ mV} \leq \Delta U \leq 200 \text{ mV}$ For Pt 100 resistance thermometer measurements Specify in plain text in addition to Order No.: Signal range: ... Shunt, $R_e = 25 \Omega \pm 0.1 \%$ $R_e = 10 \Omega \pm 0.1 \%$ Limit monitor for 32 limits with 16 channels; 2 alarm outputs per channel, selectable as maximum or minimum alarms; for channels 1 to 16 or 17 to 32 Memory chip (EPROM) Programmed for 1 scale 2 scales 3 scales 4 scales 5 scales 6 scales 7 scales 8 scales Order code(s) for the desired measuring range(s) : (pages 4/24 to 4/27) Specify in plain text: Serial No. of PIEZOGRAPH: ... Memory chip (EPROM) , programmed for linearization of scales, with 1 linearization 2 linearizations 3 linearizations 4 linearizations Order code(s) for the desired measuring range(s) : (pages 4/24 to 4/27) Specify in plain text: Serial No. of PIEZOGRAPH: ... Associated signal and range values if necessary (table or function curve)	C79453-A3031-B57 C79453-A3031-B513 C79453-A3031-B535-Z C79453-A3031-B534-Z C79453-A3031-B537-Z C79453-A3031-B536-Z ... 7ND9132-8AB 7ND9132-8AA C79453-A3031-B346 C79453-A3031-D311-Z C79453-A3031-D312-Z C79453-A3031-D313-Z C79453-A3031-D314-Z C79453-A3031-D315-Z C79453-A3031-D316-Z C79453-A3031-D317-Z C79453-A3031-D318-Z ... C79453-A3031-D321-Z C79453-A3031-D322-Z C79453-A3031-D323-Z C79453-A3031-D324-Z ...	
Hybrid recorders: PIEZOGRAPH 3 7ND2482	Memory unit for sheet-steel panel for panel with basicgrid 72 x 72	7ND2482-8AD 7ND2482-8AN	

1) A shunt is required for each current measuring point: $R_e = \frac{200 \text{ mV}}{\Delta I \text{ (mA)}}$

Spare Parts, Accessories, Consumable Material for Older Design Recorders

Further consumable material and conversion parts for servo multipoint recorders

For servo multipoint recorders

Order data	Designation	Order No.	Price
For recorders Multipoint recorders: KOMPENSOGRAF 288 x 288 7ND1060 (M73812)	Take-up spool with rubber tongues Scale cable Scale plate <ul style="list-style-type: none"> Without scale With one scale With two scales With three scales With four scales With five scales With six scales Ruler without scale Ruler with one scale Specify in addition for the Order Nos. identified by "-Z": Order code(s) (pages 4/24 to 4/27) for the desired measuring range(s)	C71452-A12-B44 C70301-A532-B42 7ND9300-8AA 7ND9300-8AB-Z 7ND9300-8AC-Z 7ND9300-8AD-Z 7ND9300-8AE-Z 7ND9300-8AF-Z 7ND9300-8AG-Z 7ND9260 7ND9270-Z ...	
	Measuring point label without inscription For six-channel recorder For twelve-channel recorder Measuring point label with inscription For six-channel recorder For twelve-channel recorder Order code: Specify in plain text: Desired text: ... (max. 23 positions per channel)	C74453-A66-C28 C74553-A66-C30 C74453-A66-C28-Z C74453-A66-C30-Z Y01	
Multipoint recorders: KOMPENSOGRAF 192 x 288 M4, M73816 and 7ND1040	Take-up spool with rubber tongues Scale cable Scale plate <ul style="list-style-type: none"> Without scale With one scale With two scales With three scales With four scales With five scales With six scales Specify in addition for the Order Nos. identified by "-Z": Order code(s) (pages 4/24 to 4/27) for the desired measuring range(s)	C71452-A12-B43 C70301-A531-B28 7ND9300-8CA 7ND9300-8CB-Z 7ND9300-8CC-Z 7ND9300-8CD-Z 7ND9300-8CE-Z 7ND9300-8CF-Z 7ND9300-8CG-Z ...	
	Measuring point label without inscription	C74453-A66-C38	
Multipoint recorders: KOMPENSOGRAF 144 x 144 7ND2020 (M73911)	Take-up spool with clamping sleeve Scale cable Wiper <ul style="list-style-type: none"> For upper potentiometer For lower potentiometer 	C72301-A20-B13 C72453-A320-B43 C74453-A56-B20 C74453-A56-B21	
	Take-up spool with clamping sleeve Scale cable Signal plug-in <ul style="list-style-type: none"> For current measurements ¹⁾ For voltage measurements For thermoelectric voltage measurements ²⁾ For resistance measurements For resistance measurements, potentiometric Specify in addition for the Order Nos. identified by "-Z": Order code (pages 4/24 to 4/27) for the desired measuring range	C72301-A20-B13 C72453-A320-B206 C74250-A58-D26-Z C74250-A58-D27-Z C74250-A58-D30-Z C74250-A58-D28-Z C74250-A58-D29-Z ...	

¹⁾ A shunt is required per measuring point with signal ranges for current measurements.

²⁾ A cold junction correction resistor R_{Cu} is required per KOMPENSOGRAF for temperature measurements with a directly connected thermocouple.

Spare Parts, Accessories, Consumable Material for Older Design Recorders

Further consumable material and conversion parts

For servo line recorders

Ordering data	Designation	Order No.	Price
For recorders Line recorders: KOMPENSOGRAF 288 x 288 M2, M73810 and 7ND1160	Ink hose for measuring system Ink reservoir , refillable Scale plate <ul style="list-style-type: none"> Without scale With one scale With two scales With three scales With four scales With five scales With six scales <p>Specify in addition for the Order Nos. identified by "-Z": Order code(s) (pages 4/24 to 4/27) for the desired measuring range(s)</p> Measuring point label without inscription Limit contact mounting set One minimum and one maximum contact Marking system mounting set New design with fiber pen assembly	C70301-A532-C60 C70429-A1532-A4 7ND9300-8BA 7ND9300-8BB-Z 7ND9300-8BC-Z 7ND9300-8BD-Z 7ND9300-8BE-Z 7ND9300-8BF-Z 7ND9300-8BG-Z ... C74453-A66-C22 C74453-A80-D30 C74453-A80-D121	
Line recorders: KOMPENSOGRAF 192 x 288 M4, K164, M73814 and 7ND1140	Take-up spool with rubber tongues Scale cable Ink hose for measuring system Ink reservoir , refillable Scale plate <ul style="list-style-type: none"> Without scale With one scale With two scales With three scales With four scales With five scales With six scales <p>Specify in addition for the Order Nos. identified by "-Z": Order code(s) (pages 4/24 to 4/27) for the desired measuring range(s)</p>	C71452-A12-B43 C70301-A531-B28 C70301-A351-C292 C70429-A1532-A4 7ND9300-8DA 7ND9300-8DB-Z 7ND9300-8DC-Z 7ND9300-8DD-Z 7ND9300-8DE-Z 7ND9300-8DF-Z 7ND9300-8DG-Z ...	
Line recorders: KOMPENSOGRAF 192 x 288 7ND1141, M73916 7ND1142, M73760	Take-up spool with rubber tongues Scale cable Ink hose <ul style="list-style-type: none"> Channel 1 Channel 2 Wiper <ul style="list-style-type: none"> For upper potentiometer For lower potentiometer Blowball	C71452-A12-B43 C72453-A56-B105 C74453-A88-C13 C74453-A88-C14 C74453-A56-B20 C74453-A56-B21 C79453-A3028-B1	

4

For servo multipoint and line recorders

Ordering data	Designation	Order No.	Price
For recorders Multipoint and line recorders: KOMPENSOGRAF 192 x 288, 288 x 288 7ND1040, 7ND1060, 7ND1140, 7ND1160, M73810 M73812 Year 1973 and later M73814 Serial No. C01-001 and later M73816	Signal plug-in For direct current, DC voltage and resistance measurements <p>Specify in addition to Order No.: Order code (pages 4/24 to 4/27) for the desired measuring range</p> Wiper For measuring and slave potentiometers, also for M2, M4 and K164 For limit contacts, not for K164 Shunt , $R_e = 10 \Omega \pm 0.1 \%$ Cold junction correction resistor R_{Cu} for 20 °C Measuring relay One relay is required per measuring point and per signal range (only with multi-range recorders), also for M2 and M4	7ND9111-Z^{1) 2)} ... C70301-A531-B285 C70301-A531-B290 7ND9132-8AA C74005-A212-A1 C70301-A532-C103	

¹⁾ A shunt is required per measuring point with signal ranges for current measurements.

²⁾ A cold junction correction resistor R_{Cu} is required per KOMPENSOGRAF for temperature measurements with a directly connected thermocouple.

Spare Parts, Accessories, Consumable Material for Older Design Recorders

Measuring ranges for signal plug-ins, scales, rulers and memory chips (EPROM)

Measuring range (scale) ²⁾	Order code for connection			1) DIN IEC 584 on request. 2) Programmed with the 7ND2480.						3) Connection via transmitter (page 4/26). 4) Pt 10 % Rh/Pt.					
	Via transmitter 0 to 20 mA, voltage-linear; temperature-linear on request	Via thermostat 50 °C	Direct With internal cold junction correction	7ND1040/1140 7ND1060/1160	7ND2021	7ND2022/32/42	7ND2023/33/43	7ND2100/01 7ND2122 7ND2121/23	7ND2124 7ND2125	7ND2130 7ND2140 7ND2150 7ND2160	7ND2131 7ND2141 7ND2151 7ND2161	7ND2132 7ND2142 7ND2152 7ND2162	7ND2270 7ND2271	7ND2320/21	7ND2324

Sensor:
Fe-CuNi thermocouple to DIN 43 710 ¹⁾

Price group

0 to 250 °C	A01	A02	A03	1	1	1	1	6	1	4	1	3	1	1	2	1	-
				1	1	-	6	6	-	7	-	8	-	1	9	-	1
				1	1	-	-	-	-	7	-	8	-	1	9	-	1
0 to 400 °C	A04	A05	A06	1	1	1	1	6	1	4	1	3	1	1	2	1	-
				1	1	-	6	6	-	7	-	8	-	1	9	-	1
				1	1	-	-	-	-	7	-	8	-	1	9	-	1
0 to 600 °C	A07	A08	A09	1	1	1	1	6	1	4	1	3	1	1	2	1	-
				1	1	-	6	6	-	7	-	8	-	1	9	-	1
				1	1	-	-	-	-	7	-	8	-	1	9	-	1
0 to 900 °C	A10	A11	A12	1	1	1	1	6	1	4	1	3	1	1	2	1	-
				1	1	-	6	6	-	7	-	8	-	1	9	-	1
				1	1	-	-	-	-	7	-	8	-	1	9	-	1
300 to 600 °C	A13	A14	A15	1	1	1	1	6	1	4	1	3	1	1	2	1	-
				1	1	-	6	6	-	7	-	8	-	1	9	-	1
				1	1	-	-	-	-	7	-	8	-	1	9	-	1

Sensor:
NiCr-Ni thermocouple to DIN 43 710 ¹⁾

Price group

0 to 250 °C	A16	A17	A18	1	1	1	1	6	1	4	1	3	1	1	2	1	-
				1	1	-	6	6	-	7	-	8	-	1	9	-	1
				1	1	-	-	-	-	7	-	8	-	1	9	-	1
0 to 400 °C	A19	A20	A21	1	1	1	1	6	1	4	1	3	1	1	2	1	-
				1	1	-	6	6	-	7	-	8	-	1	9	-	1
				1	1	-	-	-	-	7	-	8	-	1	9	-	1
0 to 600 °C	A22	A23	A24	1	1	1	1	6	1	4	1	3	1	1	2	1	-
				1	1	-	6	6	-	7	-	8	-	1	9	-	1
				1	1	-	-	-	-	7	-	8	-	1	9	-	1
0 to 900 °C	A25	A26	A27	1	1	1	1	6	1	4	1	3	1	1	2	1	-
				1	1	-	6	6	-	7	-	8	-	1	9	-	1
				1	1	-	-	-	-	7	-	8	-	1	9	-	1
0 to 1000 °C	A28	A29	A30	1	1	1	1	6	1	4	1	3	1	1	2	1	-
				1	1	-	6	6	-	7	-	8	-	1	9	-	1
				1	1	-	-	-	-	7	-	8	-	1	9	-	1
0 to 1200 °C	A31	A32	A33	1	1	1	1	6	1	4	1	3	1	1	2	1	-
				1	1	-	6	6	-	7	-	8	-	1	9	-	1
				1	1	-	-	-	-	7	-	8	-	1	9	-	1
600 to 900 °C	A34	A35	A36	1	1	1	1	6	1	4	1	3	1	1	2	1	-
				1	1	-	6	6	-	7	-	8	-	1	9	-	1
				1	1	-	-	-	-	7	-	8	-	1	9	-	1
600 to 1000 °C	A37	A38	A39	1	1	1	1	6	1	4	1	3	1	1	2	1	-
				1	1	-	6	6	-	7	-	8	-	1	9	-	1
				1	1	-	-	-	-	7	-	8	-	1	9	-	1

Sensor:
PtRh-Pt thermocouple ⁴⁾ to DIN 43 710/DIN IEC 584

Price group

0 to 1000 °C	A40	A41	A42	1	1	1	1	6	1	4	1	3	1	1	2	1	-
				1	1	-	6	6	-	7	-	8	-	1	9	-	1
				1	1	-	-	-	-	7	-	8	-	1	9	-	1
0 to 1200 °C	A43	A44	A45	1	1	1	1	6	1	4	1	3	1	1	2	1	-
				1	1	-	6	6	-	7	-	8	-	1	9	-	1
				1	1	-	-	-	-	7	-	8	-	1	9	-	1
0 to 1400 °C	A46	A47	A48	1	1	1	1	6	1	4	1	3	1	1	2	1	-
				1	1	-	6	6	-	7	-	8	-	1	9	-	1
				1	1	-	-	-	-	7	-	8	-	1	9	-	1
0 to 1600 °C	A49	A50	A51	1	1	1	1	6	1	4	1	3	1	1	2	1	-
				1	1	-	6	6	-	7	-	8	-	1	9	-	1
				1	1	-	-	-	-	7	-	8	-	1	9	-	1
0 to 1600 °C	A52	A53	A54	1	1	1	1	6	1	4	1	3	1	1	2	1	-
				1	1	-	6	6	-	7	-	8	-	1	9	-	1
				1	1	-	-	-	-	7	-	8	-	1	9	-	1

Spare Parts, Accessories, Consumable Material for Older Design Recorders

Measuring ranges for signal plug-ins, scales, rulers and memory chips (EPROM)

Measuring range (scale) ²⁾	Order code for connection		7ND1040/7ND1140 7ND1060/7ND1160	7ND2021	7ND2022/7ND2032/7ND2042	7ND2023/7ND2033/7ND2043	7ND2100/7ND2101 7ND2122 7ND2121/23	7ND2124 7ND2125	7ND2130 7ND2140 7ND2150 7ND2160	7ND2131 7ND2141 7ND2151 7ND2161	7ND2132 7ND2142 7ND2152 7ND2162	7ND2270 ⁴⁾ 7ND2271 ⁴⁾	7ND2320/7ND2321	7ND2324	7ND2480 ³⁾
	Via transmitter 0 to 20 mA, temperature-linear; resistance-linear on request	Direct													

Sensor:
Pt 100 resistance thermometer
 to DIN IEC 751
 Connection in two-wire system¹⁾
 or three-wire system;
 four-wire system on request

Price group

Measuring range	Code	1	2	3	4	5	6	7	8	9	10	11	12	13	14	15
- 30 to + 60 °C	C72 A55	1	1	1	1	1	4	1	3	1	1	2	1	-	-	-
0 to 40 °C	C73 A57	1	1	1	1	1	4	1	3	1	1	2	1	-	-	-
0 to 60 °C	C74 A59	1	1	1	1	1	4	1	3	1	1	2	1	-	-	-
0 to 80 °C	C75 A61	1	1	1	1	1	4	1	3	1	1	2	1	-	-	-
0 to 100 °C	C76 A63	1	1	1	1	1	4	1	3	1	1	2	1	-	-	-
0 to 120 °C	C77 A65	1	1	1	1	1	4	1	3	1	1	2	1	-	-	-
0 to 150 °C	C78 A67	1	1	1	1	1	4	1	3	1	1	2	1	-	-	-
0 to 200 °C	C79 A69	1	1	1	1	1	4	1	3	1	1	2	1	-	-	-
0 to 250 °C	C80 A71	1	1	1	1	1	4	1	3	1	1	2	1	-	-	-
0 to 300 °C	C81 A73	1	1	1	1	1	4	1	3	1	1	2	1	-	-	-
0 to 400 °C	C82 A75	1	1	1	1	1	4	1	3	1	1	2	1	-	-	-
0 to 500 °C	C83 A77	1	1	1	1	1	4	1	3	1	1	2	1	-	-	-
0 to 600 °C	C84 A79	1	1	1	1	1	4	1	3	1	1	2	1	-	-	-
200 to 400 °C	C85 A81	1	1	1	1	1	4	1	3	1	1	2	1	-	-	-
200 to 600 °C	C86 A83	1	1	1	1	1	4	1	3	1	1	2	1	-	-	-
400 to 600 °C	C87 A85	1	1	1	1	1	4	1	3	1	1	2	1	-	-	-

Price group ⁵⁾	Price
1	
2	
3	
4	
5	
6	
7	
8	
9	

- 1) A line symmetry resistor is required for each channel.
- 2) Programmed with the 7ND2480.
- 3) Connection via transmitter (page 4/26).
- 4) GALVANOGRAPH 7ND2270 and 7ND2271: connection to resistance thermometer only in three-wire system; two-wire system on request.
- 5) Price groups 2 to 9 and the respective prices only apply in conjunction with the signal plug-ins 7ND9118-8L-Z, 7ND9118-8K-Z, 7ND9118-8J-Z and 7ND9121-Z (page 4/17); otherwise price group 1 always applies.

Spare Parts, Accessories, Consumable Material for Older Design Recorders

Measuring ranges for signal plug-ins, scales, rulers and memory chips (EPROM)

Measuring range (scale) ¹⁾	Order code for connect.		7ND1040/7ND1140 7ND1060/7ND1160	7ND2021	7ND2022/7ND2032/7ND2042	7ND2023/7ND2033/7ND2043	7ND2100/7ND2101	7ND2122	7ND2121/7ND2123	7ND2124 7ND2125	7ND2130 7ND2140 7ND2150 7ND2160	7ND2131 7ND2141 7ND2151 7ND2161	7ND2132 7ND2142 7ND2152 7ND2162	7ND2270 7ND2271	7ND2320/7ND2321	7ND2324	7ND2480
	Via shunt	Direct or via transmitter, adapter etc. ²⁾															

Direct current

Price group

Specify measuring range in plain text	Signal range	J32 J33 J34	1	1	-	6	-	-	-	7	-	8	-	1	8	-	-
... A/ 60 mV	0 to 1 mA	J32	1	1	-	6	-	-	-	7	-	8	-	1	8	-	-
... A/150 mV	0 to 10 mA	J33	1	1	-	6	-	-	-	7	-	8	-	1	8	-	-
... A/300 mV	0 to 20 mA	J34	1	1	-	6	-	-	-	7	-	8	-	1	8	-	-

Direct current, DC voltage or any process variable with direct current or DC voltage as the input signal

Price group

Measuring range (scale)	Signal range		1	1	1	1	-	1	-	4	1	3	-	1	5	-	-
0 to 100 % linear	0 to 1 mA	H06	1	1	1	1	-	1	-	4	1	3	-	1	5	-	-
	0 to 10 mA	H08	1	1	1	1	-	1	-	4	1	3	-	1	5	1	-
	0 to 20 mA	H07	1	1	1	1	-	1	-	4	1	3	-	1	5	1	-
	4 to 20 mA	H09	1	1	1	1	-	1	-	4	1	3	1	1	5	1	-
0 to 500 mV	0 to 10 V	H10	1	1	1	1	-	-	-	4	1	3	-	1	5	-	-
	0 to 10 V	H11	-	1	1	1	-	1	1	4	1	3	-	1	5	-	-
	2 to 10 V	H12	-	1	1	1	-	1	1	4	1	3	-	1	5	-	-
Specify measuring range (scale) in plain text	0 to 1 mA	Y20	1	1	1	1	-	1	-	4	1	3	-	1	5	-	-
	0 to 10 mA	Y23	1	1	1	1	-	1	-	4	1	3	-	1	5	-	-
	0 to ±10 mA	Y65	1	1	-	-	-	-	-	4	1	3	-	1	5	2	1
	0 to 20 mA	Y24	1	1	1	1	-	1	1	4	1	3	1	1	5	2	1
	4 to 20 mA	Y25	1	1	1	1	-	1	1	4	1	3	1	1	5	1	1
0 to 500 mV	0 to 10 V	Y31	1	1	1	1	-	-	-	4	1	3	-	1	5	-	1
	0 to 10 V	Y58	-	1	1	1	-	1	1	4	1	3	-	1	5	-	1
	2 to 10 V	Y59	-	1	1	1	-	1	1	4	1	3	-	1	5	-	1
	0 to 25 V	Y84	-	-	1	1	-	1	-	4	1	4	-	-	6	-	-
Signal span (ranges other than those above)																	
Specify measuring range (scale) and signal range in plain text	> 1 to <20 mA	Y61	1	1	1	1	-	1	-	4	1	3	-	-	5	1	1
	>20 to <60 mA	Y62	1	1	1	1	-	1	-	4	1	3	-	-	5	2	1
	60 to <90 mA	Y63	-	-	1	1	-	-	-	4	1	3	-	-	-	1	1
	90 to 500 mA	Y64	-	-	-	-	-	-	-	4	-	3	-	-	-	1	1
	5 to <200 mV	Y67	1	1	-	6	-	-	-	7	-	8	-	-	8	1	1
	0.2 to <1 V	Y68	-	-	-	-	-	-	-	-	-	-	-	-	5	1	1
	1 to <40 V	Y69	-	-	1	1	-	1	-	4	1	4	-	-	5	1	1
	40 to <60 V	Y70	-	-	-	-	-	-	-	-	-	-	-	-	5	-	-
	60 to <110 V	Y71	-	-	-	-	-	-	-	-	-	-	-	-	6	-	-
	110 to <210 V	Y72	-	-	-	-	-	-	-	-	-	-	-	-	6	-	-
	210 to 310 V	Y73	-	-	-	-	-	-	-	-	-	-	-	-	6	-	-

Price group ³⁾	Price
1	
2	
3	
4	
5	
6	
7	
8	

- 1) Programmed with the 7ND2480.
- 2) With multipoint recorders, specify channel assignment in plain text for current and voltage signal ranges (full-scale value > 500 mV).
- 3) Price groups 2 to 8 and the respective prices only apply in conjunction with the signal plug-ins 7ND9118-8L-Z, 7ND9118-8K-Z, 7ND9118-8J-Z and 7ND9121-Z (page 4/17); otherwise price group 1 always applies.

Spare Parts, Accessories, Consumable Material for Older Design Recorders

Measuring ranges for signal plug-ins, scales, rulers and memory chips (EPROM)

	Ord. code for connection				
	RMS value, sinusoidal curve Direct	RMS value, any waveform			
			7ND2124 7ND2125		
			7ND2131, 7ND2133 7ND2141, 7ND2143 7ND2151, 7ND2153 7ND2161, 7ND2163		
			7ND2320, 7ND2321		

Alternating current (50 Hz) or any process variable
with alternating current (50 Hz) as input signal ¹⁾

Price group

	Signal range				
Specify measuring range (scale) and rated transformer data in plain text	0 to 1 A	Y42 L01	6 -	6 8	- 8
	0 to 5 A	Y44 L11	- -	6 8	- 8

AC voltage (50 Hz) or any process variable
with AC voltage (50 Hz) as input signal ¹⁾

	Signal span				
Specify measuring range (scale) and rated transformer data in plain text	57.5 to < 100 V	Y75 Y79	6 -	6 9	6 9
	100 to < 200 V	Y76 Y80	6 -	6 9	6 9
	200 to < 300 V	Y77 Y81	- -	6 9	6 9
	300 to 500 V	Y78 Y82	- -	6 9	- 9

SPANNUNGSLUPE
AC voltage (50 Hz) ¹⁾

	Rated voltage	Order code for direct connection			
Specify rated voltage and measuring range (scale; ± 5 to ± 20 % of rated voltage) in plain text	57.5 to 380 V	Y83	-	7	7

Measuring equipment for **frequency 50 Hz** ¹⁾

Specify measuring range (scale) and voltage value in plain text	N25	-	8	8
---	------------	---	---	---

Measuring equipment for **power factor cos φ**

Specify current and voltage values at 50 Hz ¹⁾ as well as scale in plain text	P37	-	10	10
--	------------	---	----	----

	Ord. code for connection				
	Active power Direct	Reactive power			
			7ND2131, 7ND2133 7ND2141, 7ND2143 7ND2151, 7ND2153 7ND2161, 7ND2163		
			7ND2320, 7ND2321		

Active or reactive power with single-phase current 50 Hz ¹⁾

Price group

Specify measuring range (scale) and transformer ratio in plain text	... /1A, ... / ..V	Q01	Q17	10
	... /5 A, ... / .. V	Q09	Q25	

Active or reactive power with three-wire three-phase current with balanced load 50 Hz ¹⁾

Specify measuring range (scale) and transformer ratio in plain text	... /1A, ... / ..V	R01	R17	10
	... /5 A, ... / .. V	R09	R25	

Active or reactive power with three-wire three-phase current with unbalanced load 50 Hz ¹⁾

Specify measuring range (scale) and transformer ratio in plain text	... /1A, ... / ..V	R33	R49	11
	... /5 A, ... / .. V	R41	R57	

Active or reactive power with four-wire three-phase current with unbalanced load 50 Hz ¹⁾

Specify measuring range (scale) and transformer ratio in plain text	... /1A, ... / ..V	S01	S17	12
	... /5 A, ... / .. V	S09	S25	

Price group ²⁾	Price
6	
7	
8	
9	
10	
11	
12	

¹⁾ For 60 Hz on request.

²⁾ The price groups 6 to 12 and the respective prices only apply in conjunction with the signal plug-ins 7ND9118-8L-Z, 7ND9118-8K-Z, 7ND9118-8J-Z and 7ND9121-Z (page 4/17).

Spare Parts, Accessories, Consumable Material for Older Design Recorders



4

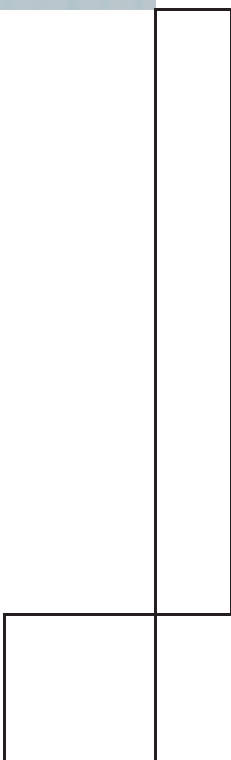

5/2	Subject index
5/4	Order no. index
5/5	Siemens contact partners
5/6	Service & Support
5/6	Information and Ordering in the Internet and on CD-ROM
5/7	Customer support
5/8	Calibration service, repair service, spare parts
5/9	Software licenses
5/10	Terms and Conditions of sale and delivery
5/10	Export regulations

Appendix

Subject index

- B**
Battery 2/15, 2/23, 2/30, 3/19
- C**
Chart paper 2/15, 2/23, 2/30, 3/19
- D**
Digital input/output 2/16, 2/30, 3/19
- F**
Fiber pen assembly 2/15
Firmware 3/19
- H**
Hybrid recorders 3/1
- I**
Ink paper 2/15, 2/23, 3/19, 4/6
Input/output 2/16, 2/30, 3/19
Interface 3/19
- L**
Line recorders 2/1
- M**
Measuring-point label 2/16, 2/23, 2/30, 3/19
Mounting set 2/16, 2/30
Multipoint recorders 2/1
- R**
Recording head 2/23, 2/30, 3/19
Recording unit 2/16, 2/23, 2/30, 3/19
Remote control unit 2/30, 3/19
Ruler 2/16, 2/23
- S**
Scale 2/16, 2/23
Serial interface 3/19
Signal module 3/19
SIREC L/LA 2/7
SIREC P/PA 2/17
SIREC PU 2/24
- T**
Take-up spool 2/16, 2/23, 2/30, 3/19
Transport housing 2/30, 3/19
- V**
VARIOGRAPH 3/7

C70...

C70301-A530-B163	4/23
C70301-A531-B28	4/22, 4/23
C70301-A531-B285	4/23
C70301-A531-B290	4/23
C70301-A531-B302	4/20
C70301-A531-B495	4/21
C70301-A531-C292	4/23
C70301-A532-B42	4/22
C70301-A532-C60	4/23
C70301-A532-C103	4/23
C70429-A63-A7	4/20
C70429-A63-A8	4/20
C70429-A63-A9	4/20
C70429-A959-A7	4/20
C70429-A959-A8	4/20
C70429-A959-A9	4/20
C70429-A1532-A4	4/23

C71...

C71452-A12-B43	4/22, 4/23
C71452-A12-B44	4/22
C71452-A64-B1	4/20
C71452-A64-B2	4/20
C71452-A64-B3	4/20

C72...

C72165-A405-B43-Z	4/18
C72165-A405-C299	4/18
C72165-A405-C299-Z	4/18
C72165-A405-C310	4/18
C72165-A405-C310-Z	4/18
C72165-A405-C320	4/18
C72165-A405-C320-Z	4/18
C72246-A138-B60	4/18
C72246-A138-B61	4/18
C72246-A138-B62	4/18
C72246-A138-B63	4/18
C72246-A138-C73	4/14
C72246-A138-C94	4/14
C72246-A144-A6	4/14
C72246-A144-A7	4/14
C72246-A144-A8	4/14
C72246-A144-A13	4/14
C72246-A144-A14	4/14
C72246-A144-A18	4/14
C72301-A20-A4	4/14
C72301-A20-A6	2/30, 3/19, 4/7, 4/14
C72301-A20-A7	2/30, 3/19, 4/7, 4/14
C72301-A20-A8	4/14
C72301-A20-A10	4/14
C72301-A20-A11	4/14
C72301-A20-A12	4/14
C72301-A20-A13	4/14
C72301-A20-A17	2/16, 2/23, 4/7
C72301-A20-B13	4/14, 4/22
C72301-A20-B53	4/14
C72301-A20-B71	4/14
C72301-A20-B72	4/14
C72301-A20-B110	2/16, 2/23, 2/30, 3/19, 4/7, 4/14
C72301-A22-A1	4/14
C72301-A22-A2	4/14
C72301-A22-B8	4/14
C72452-A92-B8	4/19
C72452-A92-B9	4/19
C72452-A92-B12	4/19
C72452-A92-B61	4/10
C72452-A92-B62	4/10
C72452-A92-B63	4/10

C72452-A94-B8	4/10
C72452-A94-B9	4/10
C72452-A94-B10	4/10
C72452-A94-B11	4/10
C72452-A94-B12	4/10
C72452-A94-B109	4/19
C72452-A94-B159	4/11
C72452-A94-B162	4/11
C72452-A94-B181	4/11
C72452-A94-B208	2/15, 2/23, 2/30, 3/19, 4/6, 4/10
C72452-A94-B209	2/15, 2/23, 2/30, 3/19, 4/6, 4/10
C72452-A94-B210	2/15, 2/23, 2/30, 3/19, 4/6, 4/10
C72452-A94-B211	2/15, 2/23, 2/30, 3/19, 4/6, 4/10
C72452-A94-B212	2/15, 2/23, 2/30, 3/19, 4/6, 4/10
C72452-A94-B262	2/15, 2/23, 2/30, 3/19, 4/6, 4/11
C72452-A94-B263	2/15, 2/23, 2/30, 3/19, 4/6, 4/11
C72452-A94-B264	2/15, 2/23, 2/30, 3/19, 4/6, 4/11
C72452-A94-B265	2/15, 2/23, 2/30, 3/19, 4/6, 4/11
C72452-A94-B266	2/15, 2/23, 2/30, 3/19, 4/6, 4/11
C72452-A96-B9	4/19
C72452-A98-B9	4/19
C72452-A98-B12	4/19
C72452-A98-B15	4/19
C72452-A98-B22	4/19
C72452-A98-B32	4/19
C72452-A98-B172	3/19
C72452-A110-B1	4/10
C72452-Z725-C27	4/12
C72452-Z725-C28	4/12
C72452-Z725-C29	4/12
C72452-Z725-C30	4/12
C72452-Z725-C31	4/12
C72452-Z725-C32	4/12
C72453-A315-B20	4/14
C72453-A315-B23	4/14
C72453-A315-B33	4/14
C72453-A315-B35	4/14
C72453-A315-C24	4/14
C72453-A320-B22	4/14
C72453-A320-B43	4/22
C72453-A320-B117	4/12
C72453-A320-B206	4/22
C72453-A321-B83	4/12
C72453-A321-B84	4/12
C72453-A321-B86	4/14
C72453-A321-B88	4/14
C72453-A321-B160	4/13
C72453-A321-B162	4/13
C72453-A340-B6	4/14
C72453-A340-B7	4/14
C72453-A340-B8	4/14
C72453-A340-C123	4/18
C72453-A340-C124	4/18
C72453-Z725-H1	4/12
C72453-Z725-H2	4/12

C74...

C74005-A212-A1	4/23
C74250-A58-D26-Z	4/22
C74250-A58-D27-Z	4/22
C74250-A58-D28-Z	4/22
C74250-A58-D29-Z	4/22
C74250-A58-D30-Z	4/22
C74301-A8-B53	4/20
C74301-A8-B54	4/20
C74301-A8-B55	4/20
C74301-A8-B56	4/20
C74315-A66-A4	4/14, 4/17
C74453-A56-B20	4/22, 4/23
C74453-A56-B21	4/22, 4/23
C74453-A56-B105	4/23
C74453-A66-C22	4/23
C74453-A66-C28	4/22
C74453-A66-C28-Z	4/22
C74453-A66-C30	4/22
C74453-A66-C30-Z	4/22
C74453-A66-C38	4/22
C74453-A80-D30	4/23
C74453-A80-D121	4/23
C74453-A88-C13	4/23
C74453-A88-C14	4/23
C74453-A172-B29	4/20

C79...

C79000-G7300-C185	3/19
C79000-G7300-C188	2/15, 2/23
C79000-G7300-C195	2/30
C79000-G7300-C79	3/19
C79000-G7372-C188	2/15, 2/23
C79000-G7372-C195	2/30
C79000-G7376-C185	3/19
C79000-G7376-C188	2/15, 2/23
C79000-G7376-C195	2/30
C79000-G7376-C79	3/19
C79000-G7377-C185	3/19
C79000-G7377-C188	2/15, 2/23
C79000-G7377-C195	2/30
C79000-G7377-C79	3/19
C79000-G7378-C188	2/15, 2/23
C79000-G7378-C195	2/30
C79000-M7300-C191	2/15, 2/23
C79000-M7300-C192	2/15, 2/23
C79000-M7300-C198	2/30
C79000-M7300-C199	2/30
C79000-M7300-C94	3/19
C79000-M7364-C193	2/15, 2/23
C79000-M7364-C200	2/30
C79000-M7372-C191	2/15, 2/23
C79000-M7372-C192	2/15, 2/23
C79000-M7372-C198	2/30
C79000-M7372-C199	2/30
C79000-M7376-C191	2/15, 2/23
C79000-M7376-C192	2/15, 2/23
C79000-M7376-C198	2/30
C79000-M7376-C199	2/30
C79000-M7376-C94	3/19
C79000-M7377-C191	2/15, 2/23
C79000-M7377-C192	2/15, 2/23
C79000-M7377-C198	2/30
C79000-M7377-C199	2/30
C79000-M7377-C94	3/19
C79000-M7378-C191	2/15, 2/23
C79000-M7378-C192	2/15, 2/23
C79000-M7378-C198	2/30
C79000-M7378-C199	2/30

Appendix

Order No. index

C79165-A3010-B127-Z	4/18				
C79165-A3010-B129-Z	4/18				
C79165-A3029-B10	3/19, 4/9				
C79165-A3029-B10-Z	3/19, 4/9				
C79165-A3029-B11	4/9				
C79165-A3029-B11-Z	4/9				
C79165-A3029-B12	4/9				
C79165-A3029-B12-Z	4/9				
C79165-A3029-B28	2/16, 2/30				
C79165-A3029-B30	2/16, 2/30				
C79165-A3029-B82	3/19				
C79165-A3029-B82-Z	3/19				
C79165-A3029-B367	2/16				
C79165-A3029-B368-Z	2/16				
C79165-A3029-B382	2/30				
C79165-A3029-B383-Z	2/30				
C79165-A3029-B402	2/23				
C79165-A3029-B403-Z	2/23				
C79301-A3000-A2	3/19				
C79301-A3000-B4	3/19				
C79453-A3011-B39	4/14				
C79453-A3011-B51	4/17				
C79453-A3011-D67	4/18				
C79453-A3011-D101	2/16, 2/30				
C79453-A3025-D69	4/18				
C79453-A3025-D70	4/18				
C79453-A3025-D83	4/14				
C79453-A3025-D157	4/18				
C79453-A3027-C72	4/14				
C79453-A3027-C75	4/14				
C79453-A3028-B1	4/14, 4/23				
C79453-A3031-B57	4/21				
C79453-A3031-B346	4/21				
C79453-A3031-B513	4/21				
C79453-A3031-B534-Z	4/21				
C79453-A3031-B535-Z	4/21				
C79453-A3031-B536-Z	4/21				
C79453-A3031-B537-Z	4/21				
C79453-A3031-D15	4/21				
C79453-A3031-D33	4/12				
C79453-A3031-D50	4/12				
C79453-A3031-D311-Z	4/12				
C79453-A3031-D312-Z	4/21				
C79453-A3031-D313-Z	4/21				
C79453-A3031-D314-Z	4/21				
C79453-A3031-D315-Z	4/21				
C79453-A3031-D316-Z	4/21				
C79453-A3031-D317-Z	4/21				
C79453-A3031-D318-Z	4/21				
C79453-A3031-D321-Z	4/21				
C79453-A3031-D322-Z	4/21				
C79453-A3031-D323-Z	4/21				
C79453-A3031-D324-Z	4/21				
C79453-A3033-B203	4/7				
C79453-A3049-B522	2/16				
C79453-A3066-B119	3/19				
C79453-A3066-B119-Z	3/19				
C79453-A3068-B9	3/19				
C79453-A3070-B104	2/15, 2/30				
M73...					
M73948-X-A1	4/20				
M73949-X-A1	4/21				
M73949-X-A2	4/21				
W79...					
W79050-U1201-U106	4/14, 4/17				
W79084-L1002-B1	2/15, 2/23, 2/30, 4/7				
W79084-L1004-B1	3/19, 4/7				
W79084-U1001-B2	4/7				
7ND...					
7ND2482-8AD	4/21				
7ND2482-8AN	4/21				
7ND2482-8NB	4/9				
7ND2482-8NC	4/9				
7ND2482-8NX	4/9				
7ND2482-8NY	4/9				
7ND2482-8PA	4/9				
7ND2482-8PB	4/9				
7ND2482-8TA	4/7				
7ND2482-8TB	4/7				
7ND2482-8TC	4/7				
7ND2482-8TD	4/7				
7ND2482-8TE	4/7				
7ND2482-8UA	4/6				
7ND2482-8UC	4/6				
7ND2482-8UD	4/6				
7ND2482-8VD	4/7, 4/12				
7ND2482-8WB	4/7				
7ND3021-...	2/22				
7ND3121-...	2/13				
7ND3125-...	2/14				
7ND3521-...	3/16				
7ND3523-...	2/29				
7ND3560-...	3/18				
7ND3590-...	3/17				
7ND9000-1AE	2/15, 2/30				
7ND9000-8EE	2/15, 2/30				
7ND9001-8AA	2/15, 4/7, 4/13				
7ND9001-8AB	2/15, 4/7, 4/13				
7ND9001-8AD	2/15, 4/7, 4/13				
7ND9001-8AE	2/15, 4/7, 4/13				
7ND9001-8AG	2/15, 4/7, 4/13				
7ND9001-8AK	4/13				
7ND9001-8AN	4/13				
7ND9001-8AR	4/13				
7ND9001-8AU	4/13				
7ND9001-8BA	4/13				
7ND9001-8BG	4/13				
7ND9001-8BK	4/13				
7ND9001-8BL	4/13				
7ND9001-8BN	4/13				
7ND9001-8BP	4/13				
7ND9001-8BR	4/13				
7ND9001-8CA	4/13				
7ND9001-8DA	4/21				
7ND9001-8DB	4/21				
7ND9001-8DC	4/21				
7ND9001-8DD	4/21				
7ND9001-8DE	4/21				
7ND9001-8DF	4/21				
7ND9001-8DG	4/21				
7ND9001-8DH	2/15				
7ND9001-8FA	4/21				
7ND9001-8FB	2/23, 2/30, 3/19, 4/7				
7ND9018-8AA	4/12				
7ND9018-8AB	4/12				
7ND9018-8AC	4/12				
7ND9050-0GB	4/12				
7ND9050-0PC	4/12				
7ND9050-0QD	4/12				
7ND9058-0AB	4/20				
7ND9058-0DB	4/20				
7ND9111-Z	4/23				
7ND9118-8G-Z	4/17				
7ND9118-8H-Z	4/17				
7ND9118-8J-Z	4/17				
7ND9118-8K-Z	4/17				
7ND9118-8L-Z	4/17				
7ND9121-Z	4/17				
7ND9132-8AA	4/21, 4/23				
7ND9132-8AB	4/17, 4/21				
7ND9190-8AA	2/30, 3/13, 3/19				
7ND9260	4/16, 4/22				
7ND9261	4/16				
7ND9262	2/16, 2/23, 4/8, 4/16				
7ND9270-Z	4/16, 4/22				
7ND9271-Z	4/16				
7ND9272-Z	2/16, 2/23, 4/8, 4/16				
7ND9281-8AB-Z	4/16				
7ND9281-8AC-Z	4/16				
7ND9281-8AD-Z	4/16				
7ND9281-8AE-Z	4/16				
7ND9281-8AF-Z	4/16				
7ND9300-8AA	4/22				
7ND9300-8AB-Z	4/22				
7ND9300-8AC-Z	4/22				
7ND9300-8AD-Z	4/22				
7ND9300-8AE-Z	4/22				
7ND9300-8AF-Z	4/22				
7ND9300-8AG-Z	4/22				
7ND9300-8BA	4/23				
7ND9300-8BB-Z	4/23				
7ND9300-8BC-Z	4/23				
7ND9300-8BD-Z	4/23				
7ND9300-8BE-Z	4/23				
7ND9300-8BF-Z	4/23				
7ND9300-8BG-Z	4/23				
7ND9300-8CA	4/22				
7ND9300-8CB-Z	4/22				
7ND9300-8CC-Z	4/22				
7ND9300-8CD-Z	4/22				
7ND9300-8CE-Z	4/22				
7ND9300-8CF-Z	4/22				
7ND9300-8CG-Z	4/22				
7ND9300-8DA	4/23				
7ND9300-8DB-Z	4/23				
7ND9300-8DC-Z	4/23				
7ND9300-8DD-Z	4/23				
7ND9300-8DE-Z	4/23				
7ND9300-8DF-Z	4/23				
7ND9300-8DG-Z	4/23				
7ND9300-8FA	4/16				
7ND9300-8FB-Z	4/16				
7ND9300-8FC-Z	4/16				
7ND9300-8FH-Z	4/16				
7ND9300-8FL-Z	4/16				
7ND9300-8HA	4/16				
7ND9300-8HB-Z	4/16				
7ND9300-8NA	4/16				
7ND9300-8NB-Z	4/16				
7ND9300-8NH-Z	4/16				
7ND9300-8NJ-Z	4/16				
7ND9300-8NK-Z	4/16				
7ND9300-8NL-Z	4/16				
7ND9300-8PA	4/16				
7ND9300-8PB-Z	4/16				
7ND9300-8PC-Z	4/16				
7ND9300-8PH-Z	4/16				
7ND9300-8PJ-Z	4/16				
7ND9300-8QA	2/23, 4/8				
7ND9300-8QB-Z	2/23, 4/8				
7ND9300-8QC-Z	2/23, 4/8				
7ND9300-8QD-Z	2/23, 4/8				
7ND9300-8QE-Z	2/23, 4/8				
7ND9300-8RA	2/16, 4/8				
7ND9300-8RB	2/16, 4/8				
7ND9300-8RC	2/16, 4/8				
7ND9400-8AA	3/19, 4/9				
7ND9400-8AB	4/9				
7ND9400-8AC	4/9				
7ND9400-8AF	3/19, 4/9				
7ND9400-8AJ	3/12, 3/19				
7ND9400-8BB	3/13, 3/19				
7ND9400-8BE	2/16, 2/23, 2/30				
7ND9400-8BF	2/16, 2/23, 2/30				
7ND9400-8BG	2/16, 2/23, 2/30				
7ND9400-8BH	3/19				
7ND9500-8AA3	2/15, 2/23, 2/30				
7ND9500-8AA4	2/15, 2/23, 2/30				
7ND9500-8AB1	3/19				
7ND9500-8AB2	3/19				
7ND9500-8AC1	3/19				
7ND9500-8AC2	3/19				

Siemens contacts worldwide

SIEMENS
 Local Partners Worldwide
 Germany
 Are you looking for a local contact to help you with questions on Automation and Drives products?
 No problem. First select the city nearest to your location.
 → Select other country...
 Berlin
 And to be able to name the best contact to deal with your questions we need to know the area your question refers to.
 Berlin
 Next >
 © 2003 Siemens, Automation and Drives
 Contact

SIEMENS
 Local Partners Worldwide
 Please select a sector.
 Select area/sector | Select city | Your contact
 Sectors | Select a Sector
 On which sector* do your question related mainly?
 ADD Sectors
 Wire Systems, Visualization Systems
 Electrical Infrastructure
 Material Flow, Conveying, Distribution and Logistics
 Assembly Control
 Paper Machines
 Production Automation in the Automotive Industry and Suppliers
 Production Logistics and Control Systems
 Production Machines, Feeders, Presses, Metal Forming, Milling, Drilling, Chemical processing, Stone processing, Textiles, Printing, Lithography
 Process Control Systems
 Intelligent Assembly
 * This list contains only Siemens products from the range of solutions of Automation and Drives Systems
 Which area does your question concern?
 Berlin
 Next >
 Contact

SIEMENS
 Local Partners Worldwide
 Please select a Siemens product group
 Select area/product | Select city | Your contact
 Product Catalog | Select a Product
 To which product* does your question refer to mainly?
 ADD Product Catalog
 Drive Technology
 Automation systems
 Communication Networks
 Low-voltage switching technology
 Electrical Installation Technology
 Process automation
 Sensor technology, assembly and test engineering
 Power supplies
 Safety systems - Safety Integrated
 Control systems and products for machines
 * This list contains only Siemens products from the Automation and Drives line of products
 Which area does your question concern?
 Berlin
 Next >
 Contact

At

www.siemens.com/automation/partner

you can find details of Siemens contact partners worldwide responsible for particular technologies.

You can obtain in most cases a contact partner for

- Technical Support,
- Spares/repairs,
- Service,
- Training,
- Sales or
- Consultation/engineering.

You start by selecting a

- Country,
- Product or
- Sector.

By further specifying the remaining criteria you will find exactly the right contact partner with his/her respective expertise:

Need more Information?

Then fax us!

Under the fax no.

0 08 00-74 62 84 27

you will find further information.

Appendix Service & Support

Information and Ordering in the Internet and on CD-ROM

A&D in the WWW



A detailed knowledge of the range of products and services available is essential when planning and configuring automation systems. It goes without saying that this information must always be fully up-to-date.

The Siemens Automation and Drives Group (A&D) has therefore built up a comprehensive range of information in the World Wide Web, which offers quick and easy access to all data required.

Under the address

www.siemens.com/automation

you will find everything you need to know about products, systems and services.

Product Selection Using the Interactive Catalogs

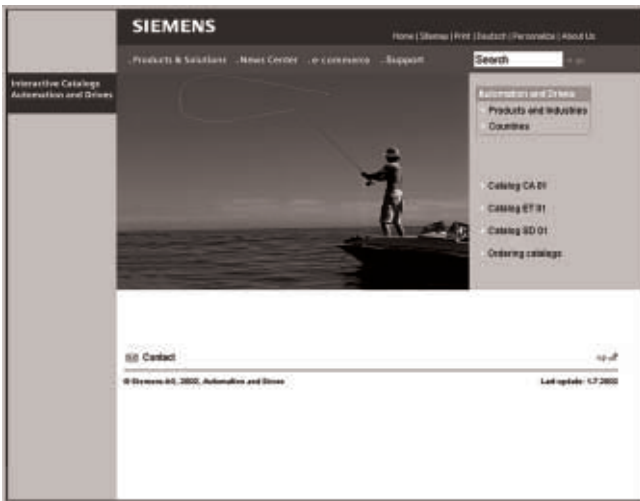

Detailed information together with convenient interactive functions:

The interactive catalogs CA 01 and SD 01 cover more than 80,000 products and thus provide a full summary of the Siemens Automation and Drives product base.

Here you will find everything that you need to solve tasks in the fields of automation, switchgear, installation and drives. All information is linked into a user interface which is easy to work with and intuitive.

After selecting the product of your choice you can order at the press of a button, by fax or by online link.

Information on the interactive catalogs can be found in the Internet under

www.siemens.com/automation/ca01

or on CD-ROM:

- Automation & Drives CA 01,
Order No.: E86060-D4001-A100-B8-7600
- Standard Drives SD 01,
Order No.: E86060-D5201-A100-A3-7600

Easy Shopping with the A&D Mall



The A&D Mall is the virtual department store of Siemens AG in the Internet. Here you have access to a huge range of products presented in electronic catalogs in an informative and attractive way.

Data transfer via EDIFACT allows the whole procedure from selection through ordering to tracking of the order to be carried out online via the Internet.

Numerous functions are available to support you.

For example, powerful search functions make it easy to find the required products, which can be immediately checked for availability. Customer-specific discounts and preparation of quotes can be carried out online as well as order tracking and tracing.

Please visit the A&D Mall on the Internet under:

www.siemens.com/automation/mall

Our Services for Every Phase of Your Project



In the face of harsh competition you need optimum conditions to keep ahead all the time:

A strong starting position. A sophisticated strategy and team for the necessary support - in every phase.

Service & Support from Siemens provides this support with a complete range of different services for automation and drives.

In every phase: from planning and startup to maintenance and upgrading.

Our specialists know when and where to act to keep the productivity and cost-effectiveness of your system running in top form.

Online Support

The comprehensive information system available round the clock via Internet ranging from Product Support and Service & Support services to Support Tools in the Shop.

www.siemens.com/automation/service&support



Technical Support



Competent consulting in technical questions covering a wide range of customer-oriented services for all our products and systems.

Tel.: +49 (0)180 50 50 222
Fax: +49 (0)180 50 50 223

E-Mail:
adsupport@siemens.com

Technical Consulting



Support in the planning and designing of your project from detailed actual-state analysis, target definition and consulting on product and system questions right to the creation of the automation solution.

Get in touch with the sales contact in your region for questions about these services.

Our Helpline (tel.: +49 (0) 180 50 50 111) will also put you through to the right contact or just visit our Internet site.

Configuration and Software Engineering

Support in configuring and developing with customer-oriented services from actual configuration to implementation of the automation project.

Get in touch with the sales contact in your region for questions about these services.

Our Helpline (tel.: +49 (0) 180 50 50 111) will also put you through to the right contact or just visit our Internet site.



Service On Site

With Service On Site we offer services for startup and maintenance, essential for ensuring system availability.

In Germany
Tel.: 0180 50 50 444

For country-specific telephone numbers go to our Internet site at

www.siemens.com/automation/service&support



Repairs and Spare Parts

In the operating phase of a machine or automation system we provide a comprehensive repair and spare parts service ensuring the highest degree of operating safety and reliability.

In Germany
Tel.: 0180 50 50 448

For country-specific telephone numbers go to our Internet site at

www.siemens.com/automation/service&support



Optimization and Upgrading

To enhance productivity and save costs in your project we offer high-quality services in optimization and upgrading.

Get in touch with the sales contact in your region for questions about these services.

Our Helpline (tel.: +49 (0) 180 50 50 111) will also put you through to the right contact or just visit our Internet site.



Appendix Service & Support

Customer Support

Knowledge Base on CD-ROM



For locations without online connections to the Internet there are excerpts of the free part of the information sources available on CD-ROM (Service & Support Knowledge Base). This CD-ROM contains all the latest product information at the time of production (FAQs, Downloads, Tips and Tricks, Updates) as well as general information on Service and Technical Support.

The CD-ROM also includes a full-text search and our Knowledge Manager for targeted searches for solutions. The CD-ROM will be updated every 4 months.

Just the same as our online offer in the Internet, the Service & Support Knowledge Base on CD comes complete in 5 languages (German, English, French, Italian, Spanish).

You can order the **Service & Support Knowledge Base CD** from your Siemens contact.

Order no. **6ZB5310-0EP30-0BA2**

Orders via the Internet

(with Automation Value Card or credit card) at:

www.siemens.com/automation/service&support

in the Shop domain.

Automation Value Card



5

Small card - great support

The Automation Value Card is an integral component of the comprehensive service concept with which Siemens Automation and Drives will accompany you in each phase of your automation project.

It doesn't matter whether you want just specific services from our Technical Support or want to purchase high-quality Support Tools in our Online Shop, you can always pay with your Automation Value Card. No invoicing, transparent and safe. With your personal card number and associated PIN you can view the state of your account and all transactions at any time.

Services on card. This is how it's done.

Card number and PIN are on the back of the Automation Value Card. When delivered, the PIN is covered by a scratch field, guaranteeing that the full credit is on the card.

By entering the card number and PIN you have full access to the Service & Support services being offered. The charge for the services procured is debited from the credits on your Automation Value Card.

All the services offered are marked in currency-neutral credits, so you can use the Automation Value Card worldwide.

Automation Value Card order numbers

Credits	Order no.
200	6ES7 997-0BA00-0XA0
500	6ES7 997-0BB00-0XA0
1000	6ES7 997-0BC00-0XA0
10000	6ES7 997-0BG00-0XA0

Detailed information on the services offered is available on our Internet site at:

www.siemens.com/automation/service&support

Service & Support à la Card: Examples

Technical Support

„Priority“ Priority processing for urgent cases

„24 h“ Availability round the clock

„Extended“ Technical consulting for complex questions

Support Tools in the Support Shop

„System Utilities“ Tools that can be used directly for configuration, analysis and testing

„Applications“ Complete topic solutions including ready-tested software

„Functions & Samples“ Adaptable blocks for accelerating your developments

Calibration service – Repair service – Spare parts

For the products in this catalog as well as products from this range which are no longer manufactured (no longer listed in this catalog) calibration service, repair service and spare parts are carried out by our central servicing department:

Siemens AG
Industrial Solutions and Services
I&S IS SC S RC DIT1
Siemensstr. 33
D-71254 Ditzingen

Tel.: +49 711 137-6093

Fax: +49 711 137-662

e-mail: herbert.bantele@siemens.com



Software types

Software requiring a license is categorized into types. The following software types have been defined:

- Engineering software
- Runtime software

Engineering software

This includes all software products for creating (engineering) user software, e.g. for configuring, programming, parameterizing, testing, commissioning or servicing.

Data generated with engineering software and executable programs can be duplicated for your own use or for use by third-parties free-of-charge.

Runtime software

This includes all software products required for plant/machine operation, e.g. operating system, basic system, system expansions, drivers, etc.

The duplication of the runtime software and executable programs created with the runtime software for your own use or for use by third-parties is subject to a charge.

You can find information about license fees according to use in the ordering data (e.g. in the catalog). Examples of categories of use include per CPU, per installation, per channel, per instance, per axis, per control loop, per variable, etc.

Information about extended rights of use for parameterization/configuration tools supplied as integral components of the scope of delivery can be found in the readme file supplied with the relevant product(s).

License types

Siemens Automation & Drives offers various types of software license:

- Floating license
- Single license
- Rental license
- Trial license

Floating license

The software may be installed for internal use on any number of devices by the licensee. Only the concurrent user is licensed. The concurrent user is the person using the program. Use begins when the software is started.

A license is required for each concurrent user.

Single license

Unlike the floating license, a single license permits only one installation of the software.

The type of use licensed is specified in the ordering data and in the Certificate of License (CoL). Types of use include for example per device, per axis, per channel, etc.

One single license is required for each type of use defined.

Rental license

A rental license supports the "sporadic use" of engineering software. Once the license key has been installed, the software can be used for a specific number of hours (the operating hours do not have to be consecutive).

One license is required for each installation of the software.

Trial license

A trial license supports "short-term use" of the software in a non-productive context, e.g. for testing and evaluation purposes. It can be transferred to another license.

Downgrading

The licensee is permitted to use the software or an earlier version/release of the software, provided that the licensee owns such a version/release and its use is technically feasible.

Delivered versions

Software is constantly being updated. The following delivery versions

- PowerPack
- Upgrade

can be used to access updates.

Existing bug fixes are supplied with the ServicePack version.

PowerPack

PowerPacks can be used to upgrade to more powerful software. The licensee receives a new license agreement and CoL (Certificate of License) with the PowerPack. This CoL, together with the CoL for the original product, proves that the new software is licensed.

A separate PowerPack must be purchased for each original license of the software to be replaced.

Upgrade

An upgrade permits the use of a new version of the software on the condition that a license for a previous version of the product is already held.

The licensee receives a new license agreement and CoL with the upgrade. This CoL, together with the CoL for the previous product, proves that the new version is licensed.

A separate upgrade must be purchased for each original license of the software to be upgraded.

ServicePack

ServicePacks are used to debug existing products. ServicePacks may be duplicated for use as prescribed according to the number of existing original licenses.



Detailed explanations concerning license conditions can be found in the "Terms and Conditions of Siemens AG" (see last page) or with the A&D Mall Online-Help System under



www.siemens.com/automation/mall

License key

Siemens Automation & Drives supplies software products with and without license keys.

The license key serves as an electronic license stamp and is also the "switch" for activating the software (floating license, rental license, etc.).

The complete installation of software products requiring license keys includes the program to be licensed (the software) and the license key (which represents the license).

Certificate of License

The Certificate of License (CoL) is the licensee's proof that the use of the software has been licensed by Siemens.

A CoL is required for every type of use and must be kept in a safe place.

Appendix

Conditions of sale and delivery

Terms and Conditions of sale and delivery

Export regulations

Terms and Conditions of Sale and Delivery

in the Federal Republic of Germany

By using this catalog you can acquire hardware and software products described therein from the Siemens AG subject to the following terms. Please note! The scope, the quality and the conditions for supplies and services, including software products, by any Siemens entity having a registered office outside the Federal Republic of Germany, shall be subject exclusively to the General Terms and Conditions of the respective Siemens entity.

for customers based in the Federal Republic of Germany

The General Terms of Payment as well as the General Conditions for the Supply of Products and Services of the Electrical and Electronics Industry shall apply.

For software products, the General License Conditions for Software Products for Automation and Drives for Customers with Seat or registered Office in Germany shall apply.

for customers with a seat or registered office outside the Federal Republic of Germany

The General Terms of Payment as well as the General Conditions for Supplies of Siemens Automation and Drives for Customers with a Seat or registered Office outside of Germany shall apply.

For software products, the General License Conditions for Software Products for Automation and Drives for Customers with Seat or registered Office outside of Germany shall apply.

General

The prices are in € (Euro) ex works, exclusive packaging. A surcharge of 25.- Euros is added to orders under 100.- Euros.

The sales tax (value added tax) is not included in the prices. It shall be debited separately at the respective rate according to the applicable legal regulations.

In addition to the prices of products which include silver and/or copper, surcharges may be calculated if the respective limits of the notes are exceeded.

Prices are subject to change without prior notice. We will debit the prices valid at the time of delivery.

The dimensions are in mm. Illustrations are not binding.

Insofar as there are no remarks on the corresponding pages, - especially with regard to data, dimensions and weights given - these are subject to change without prior notice.

Comprehensive Terms and Conditions of Sale and Delivery are available free of charge from your local Siemens business office under the following Order Nos.:

- 6ZB5310-OKR30-0BA0
(for customers based in the Federal Republic of Germany)
- 6ZB5310-OKS53-0BA0
(for customers based outside of the Federal Republic of Germany)

or download them from the Internet:
www.siemens.com/automation/mall
(A&D Mall Online-Help System)

Export regulations

The products listed in this catalog / price list may be subject to European / German and/or US export regulations.

Therefore, any export requiring a license is subject to approval by the competent authorities.

According to current provisions, the following export regulations must be observed with respect to the products featured in this catalog / price list:

AL	Number of the <u>German Export List</u> . Products marked other than "N" require an export license. In the case of software products, the export designations of the relevant data medium must also be generally adhered to. Goods labeled with an " <u>AL not equal to N</u> " are subject to a European or German export authorization when being exported out of the EU.
ECCN	<u>Export Control Classification Number</u> . Products marked other than "N" are subject to a reexport license to specific countries. In the case of software products, the export designations of the relevant data medium must also be generally adhered to. Goods labeled with an " <u>ECCN not equal to N</u> " are subject to a US re-export authorization.

Even without a label or with an "AL: N" or "ECCN: N", authorization may be required due to the final destination and purpose for which the goods are to be used.

The deciding factors are the AL or ECCN export authorization indicated on order confirmations, delivery notes and invoices.

Subject to change without prior notice.



Siemens AG
Automation and Drives
[Process Instrumentation and Analytics](http://www.siemens.com/automation/mall)
D-76181 Karlsruhe
Federal Republic of Germany

Order No.: E86060-K6020-A101-A3-7600
This catalog is also available as PDF file in the Internet.
Download is possible under: www.siemens.com/fielddevices
under [Products & Solutions](#), → [Process Recorders](#)
Printed in the Federal Republic of Germany
KG K 0703 3.0 SR 96 En / 315182

Catalogs of the Automation and Drives Group (A&D)

Further information can be obtained from our branch offices listed in the appendix of this catalog

Automation & Drives	<i>Catalog</i>		
Interactive catalog on CD-ROM			
• Components for Automation & Drives	CA 01		
Automation Systems for Machine Tools			
SINUMERIK & SIMODRIVE	NC 60		
Cables, Connectors and System Components	NC Z		
Drive Systems			
<u>Variable-Speed Drives</u>			
DC Motors	DA 12		
DC Drives Preferred Series up to 500 kW	DA 12.1		
DC Drives Preferred Series 215 kW to 1500 kW	DA 12.2		
SIMOREG DC MASTER 6RA70 Digital Chassis Converters	DA 21.1		
SIMOREG K 6RA22 Analog Chassis Converters	DA 21.2		
SIMOREG DC MASTER 6RM70 Digital Converter Cabinet Units	DA 22		
SIMOVERT PM Modular Converter Systems	DA 45		
SIEMOSYN Motors	DA 48		
MICROMASTER 410/420/430/440 Inverters	DA 51.2		
MICROMASTER 411/COMBIMASTER 411	DA 51.3		
SIMOVERT MV Medium-Voltage Drives	DA 63		
SIMOVERT MASTERDRIVES Vector Control	DA 65.10		
SIMOVERT MASTERDRIVES Motion Control	DA 65.11		
Synchronous and asynchronous servomotors for SIMOVERT MASTERDRIVES	DA 65.3		
SIMODRIVE 611 universal and POSMO	DA 65.4		
<u>Automation Systems for Machine Tools SIMODRIVE</u>	NC 60		
• AC Main Spindle Motors 1PM, 1FE, 1PH			
• AC Servomotors 1FT, 1FK			
• AC Linear motors 1FN			
• Converter System SIMODRIVE 611			
• Converter Systems SIMODRIVE POSMO A/CD/CA/SI			
<u>Low-Voltage Three-Phase-Motors</u>			
Project Manual	M 10		
Squirrel-Cage Motors, Totally Enclosed, Fan-Cooled	M 11		
<u>Drive and Control Components for Hoisting Equipment</u>	HE 1		
Electrical Installation Technology			
<i>PDF: ALPHA Small Distribution Boards and Distribution Boards</i>	ETA 1		
<i>PDF: ALPHA Side-by-Side Switchgear Cabinets</i>	ETA 3		
<i>PDF: BETA Modular Installation Devices</i>	ET B1		
<i>PDF: DELTA Switches and Outlets</i>	ET D1		
<i>PDF: GAMMA Building Management Systems</i>	ET G1		
Human Machine Interface Systems SIMATIC HMI	ST 80		
Industrial Communication and Field Devices	IK PI		
Low-Voltage Controls and Distribution	<i>Catalog</i>		
<u>Low-Voltage Controlgear, Switchgear and Systems</u>	NS K		
Communication-Capable Controlgear, Controlgear with SIRIUS, SIGUARD Safety Systems, Control and Signalling Devices, Switchgear, Transformers and DC Power Supplies, Main- and EMERGENCY-STOP Switches, Control Switches, Terminal Blocks			
BERO - Sensors for Automation Products and Systems for Low-Voltage Power Distribution	NS BERO NS PS		
SENTRON WL	NS WL		
Motion Control System SIMOTION	PM 10		
Process Instrumentation and Analytics			
Field Instruments for Process Automation	FI 01		
Measuring Instruments for Pressure, Differential Pressure, Flow, Level and Temperature, Positioners and Liquid Meters			
<i>PDF: Indicators for panel mounting</i>	MP 12		
Process Recorders and Accessories	MP 20		
SIPART, Controllers and Software	MP 31		
SIWAREX Weighing Systems	WT 01		
Gas Analysis Equipment for the Process Industry	PA 10		
<i>PDF: Process Analytics, Components for Sample Preparation</i>	PA 11		
SIPAN Liquid Analysis	PA 20		
SIMATIC Industrial Automation Systems			
SIMATIC PCS Process Control System	ST 45		
<i>PDF: SIMATIC S5/PC/505 Automation Systems</i>	ST 50		
Components for Totally Integrated Automation	ST 70		
SIMATIC PCS 7 Process Control System	ST PCS 7		
<i>PDF: Add-ons for the SIMATIC PCS 7 Process Control System</i>	ST PCS 7.A		
SIMATIC Control Systems	ST DA		
SIPOS Electric Actuators			
Electric Rotary, Linear and Part-turn Actuators	MP 35		
Electric Rotary Actuators for Nuclear Plants	MP 35.1/2		
Systems Engineering			
Power supplies SITOP power	KT 10.1		
System cabling SIMATIC TOP connect	KT 10.2		
MOBY Identification Systems	KT 21		
Industrial Microcomputers SICOMP	KT 51		
System Solutions			
Applications and Products for Industry are part of the interactive catalog CA 01			
TELEPERM M Process Control System			
AS 235, AS 235H and AS 235K automation systems	PLT 111		
<i>PDF: AS 488/TM automation systems</i>	PLT 112		
Operating and monitoring with WinCC/TM	PLT 123		
CS 275 bus system	PLT 130		



The information provided in this catalog contains descriptions or characteristics of performance which in case of actual use do not always apply as described or which may change as a result of further development of the products. An obligation to provide the respective characteristics shall only exist if expressly agreed in the terms of contract. Availability and technical specifications are subject to change without notice.

Siemens AG

Automation and Drives

Process Instrumentation and Analytics

www.siemens.com/fielddevices

Order No. E86060-K6020-A101-A3-7600