

COPPER CONNECTIVITY



P.26
COPPER
WORKSTATION



P.44
COPPER
PATCH PANELS

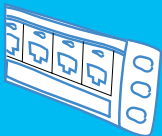

P.56
SNAP PRE-TERMINATED
CABLING SYSTEM



P.62
COPPER
CORDS



P.68
INDUSTRIAL
SOLUTIONS



P.70
110 CROSS
CONNECT

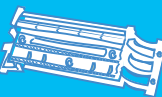

▶ COPPER CONNECTIVITY

Copper Workstation



Evolving networks demand the technology to support elevated performance requirements. Reality necessitates this elevated performance be delivered via a design that will meet specific mechanical, environmental and aesthetic workstation requirements. Legrand | Ortronics provides industry leading performance in both the individual footprint of TracJack® and the rugged module footprint of Series II®—two premium workstation approaches with a common mission to provide the best quality, performance and value.



FEATURED PRODUCTS

TracJack



Series II Modules
& Faceplates



AIV
Connectivity



Multimedia
Workstations



Clarity
6A/10G
TracJack
P.28



P.28
Clarity
6A/10G
TracJacks



P.28
Clarity 6 and
Clarity 5E Center
Tuned, Enhanced
Category 6 and
5e TracJacks



P.29
Additional
TracJack
Modules for
Applications and
Other Media



P.30
Single Gang and
Double Gang
TracJack
Faceplates



P.32
Surface
Housings
for TracJack



P.33
TracJack
Furniture Bezels



P.34
Clarity 6 and
Clarity 5E Center
Tuned, Enhanced
Category 6 and 5e
Series II Modules



P.34
Series II
Jack Modules
for Other
Applications



P.35
Additional Series
II Connector
Modules for
Other Media

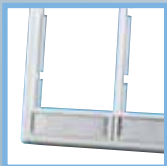

P.35
Single Gang
Plastic, Double
Gang Plastic &
Angled Series II
Faceplates



P.36
Surface Housings
for Series II



P.36
Furniture Plates
for Series II



P.37
Series II
Solutions



P.38
TracJack
Solutions



P.39
Keystone
Solutions



P.40
Fib-or-Cop II



P.42
MUTOA Mac-Pak

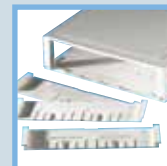

P.42
Multimedia
Outlet (MMO)



TracJack
Undercover
Wallplate
P.32



Fib-or-Cop II
P.40



TRACJACK® Clarity® Unshielded Modules

NOTE: All Ortronics product dimensions are listed by width, height and depth unless specified otherwise.

TracJack® modules combine the ease and reliability of a front-loading individual jack with preferred 110 termination and offer universal T568A/B wiring.

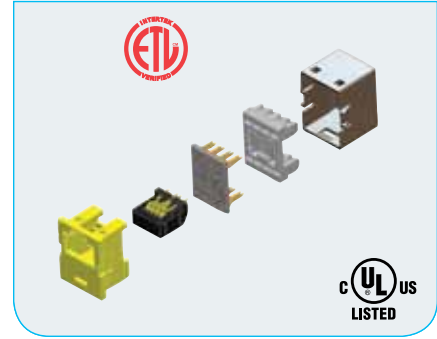

OR-TJ6A



Clarity 6A/10G Category 6A TracJacks

Clarity 6A TracJacks now offer the elevated performance of quad reactance minimize internal crosstalk and reduce the injection of common mode noise, a significant source of alien crosstalk. These connectors work with Clarity 10G patch cords to provide a nearly transparent signal path for enhanced signal-to-noise (internal and alien) performance.

These front-loading jacks are icon-compatible and can be used in any TracJack workstation outlet. Meets TIA 568C.2 augmented Category 6 component specifications.

PART NO.	DESCRIPTION
OR-TJ6A	Clarity® 6A/10G, 180° exit, fog white

NOTE: T568A/B wiring.
Clarity 6A jacks are available in these colors: -00=black, -36=blue, -42=red, -43=orange, -44=yellow, -45=green, -68=Wiremold® gray, -88=white, -99=Wiremold ivory. Add tailcode to end of part number.

OR-TJ600



Clarity 6 and Clarity 5E Center Tuned, Enhanced Category 6 and 5e TracJacks

Ortronics Clarity® TracJacks feature the improved performance of center tuned Category 6 or 5e connector technology. Enhanced IDC designs make it easier to terminate while reducing the size of the jack.

PART NO.	DESCRIPTION
OR-TJ600	Clarity 6 jack, 8-position, 180° exit, fog white
OR-TJ645	Clarity 6 jack, 8-position, 45° exit, fog white
OR-TJ5E00	Clarity 5e jack, 8-position, 180° exit, fog white
OR-TJ5E45	Clarity 5e jack, 8-position, 45° exit, fog white

NOTE: T568A/B wiring. Icon compatible.
See color chart below for available colors.

OR-TJ645



OR-TJ5E00



OR-TJ5E45



fog white	-00	-13	-36	-42	-43	-44	-45	-68
-78	-88	-99	-22	-23	-24	-25	-26	-27

NOTE: Clarity TJ5E00 and TJ600 jacks are available in all colors listed above. The Clarity TJ5E45 and TJ645 are not available in colors 22-27. WM indicates Wiremold color match. These color samples correspond with the tail codes inserted at the end of Ortronics part numbers (ex: OR-TJ600-45). Fog white is standard, requiring no tail code. Consult sales for availability and other colors.

TRACJACK® Clarity® Shielded Modules

Clarity Shielded TracJacks meet TIA Category 6A, Category 6 and Category 5e component specifications and are precisely tuned to the terminated plug values of Clarity patch cords for optimum performance that is field measurable in the channel. Clarity uses dual reactance technology to enhance signal-to-noise ratio, providing a nearly transparent signal path.

- Exceeds ISO 11801 2nd edition including EN50173 2nd edition
- Meets IEC 60603-7-5 2nd edition (draft) specifications
- ETL 3rd party component tested and verified
- Easy lace IDC housing accepts larger conductors
- Easy to follow universal wiring label—quick and user-friendly
- Fits in all TracJack plates and housings
- Icon compatible, 6A, C6 and 5E marking on jack face
- Backward compatible to shielded Category 3, 5, 5e and 6
- Center tuned connectivity design
- Compatible with 110 impact tool

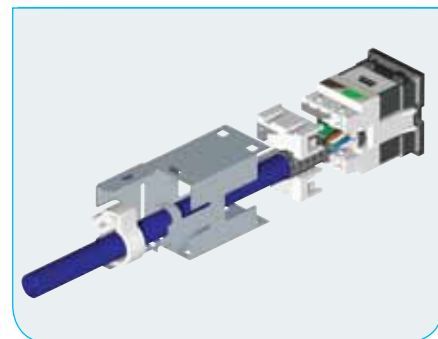

Clarity 6 and Clarity 5E Shielded Category 6A, 6 and 5e TracJacks

OR-TJS600



PART NO.	DESCRIPTION
OR-TJS6A	Clarity 6, Category 6A shielded jack, 8-position, 180° exit
OR-TJS600	Clarity 6, Category 6 shielded jack, 8-position, 180° exit
OR-TJS5E00	Clarity 5E, Category 5e shielded jack, 8-position, 180° exit

NOTE: T568A/B wiring.

TRACJACK Additional Modules

See page 196 for
Fiber TracJack
modules

Additional TracJack® Modules

OR-63730003



OR-63700005



PART NO.	DESCRIPTION
OR-63730003	Category 3 jack, 8-position, 180° exit, T568A/B wiring. Icon compatible
OR-63700005*	RJ25 jack, 6-position, 180° exit, USOC wiring. Icon compatible

NOTE: Standard color for TracJack modules is fog white.

*Indicates also available in -99 Wiremold ivory and -88 white. Contact Ortronics sales department for other colors.

TRACJACK® Faceplates

NOTE: All Ortronics product dimensions are listed by width, height and depth unless specified otherwise.

Legrand | Ortronics offers a full range of TracJack® faceplates in plastic or stainless steel, with a variety of port capacities to match your workstation applications. All TracJack plates offer recessed label fields and slotted screw holes to adjust alignment. They are ruggedly constructed from high impact thermo-plastic 94V-0 rated to ensure long life. Two to 12-port plastic wall plates now include the ability to rear-load TracJack modules.



Single Gang Plastic TracJack Faceplates

PART NO.	DESCRIPTION
OR-40300549	Holds one TracJack, 2.75" x 4.5"
OR-40300548	Holds two TracJacks, 2.75" x 4.5"
OR-40300547	Holds three TracJacks, 2.75" x 4.5"
OR-40300546	Holds four TracJacks, 2.75" x 4.5"
OR-40300545	Holds six TracJacks, 2.75" x 4.5"

NOTE: Standard color for plastic TracJack faceplates is fog white. For electrical ivory add -13, for white add -88 and for Wiremold® ivory add -99 to end of part number. For other colors, contact sales.

Single Gang Stainless Steel TracJack Faceplates

PART NO.	DESCRIPTION
OR-403STJ11	Holds one TracJack, 2.75" x 4.5"
OR-403STJ12	Holds two TracJacks, 2.75" x 4.5"
OR-403STJ13	Holds three TracJacks, 2.75" x 4.5"
OR-403STJ14	Holds four TracJacks, 2.75" x 4.5"
OR-403STJ16	Holds six TracJacks, 2.75" x 4.5"

Double Gang Plastic TracJack Faceplates

PART NO.	DESCRIPTION
OR-40300555	Holds six TracJacks, 4.5" x 4.5"
OR-40300554	Holds eight TracJacks, 4.5" x 4.5"
OR-40300620	Holds twelve TracJacks, 4.5" x 4.5"

NOTE: Standard color for TracJack plastic faceplates is fog white. For other available colors, contact sales.

Double Gang Stainless Steel TracJack Faceplates

PART NO.	DESCRIPTION
OR-403STJ28	Holds eight TracJacks, 4.5" x 4.5"
OR-403STJ212	Holds twelve TracJacks, 4.5" x 4.5"

TRACJACK® Plate Mountings

NOTE: All Ortronics product dimensions are listed by width, height and depth unless specified otherwise.

Legrand | Ortronics offers TracJack® mountings in both the 106-Type duplex footprint or the Stylistics® rectangular (GFCI) footprint, with a variety of port capacities to match your workstation applications. These two footprints are common to Wiremold® and many other industry standard raceway, furniture, pedestals and floor boxes. Legrand | Ortronics also offers plastic cover plates with recessed label fields and slotted screw holes to adjust alignment. All parts are ruggedly constructed from high impact thermo-plastic 94V-0 rated to ensure long life.



106-Type TracJack Frames

PART NO.	DESCRIPTION	
OR-40800017	OR-40800017*	Holds two TracJacks
OR-40800018	OR-40800018	Holds three TracJacks
OR-40800019	OR-40800019*	Holds four TracJacks



NOTE: Standard color is fog white.

* Indicates also available in -99 Wiremold ivory and -88 white.

106-Type Plastic Cover Plates

PART NO.	DESCRIPTION	
OR-40300255	OR-40300255	Single gang cover, 2.75" x 4.5"
OR-40300256	OR-40300256	Double gang cover, 4.5" x 4.5"



NOTE: Standard color for 106-Type Cover Plate is fog white. For other colors, contact sales.

Stylistics TracJack Frames

PART NO.	DESCRIPTION	
OR-41900017	OR-41900017*	Holds three TracJacks
OR-41900018	OR-41900018*	Holds four TracJacks



NOTE: Standard color is fog white.

* Indicates also available in -99 Wiremold ivory

Stylistics Plastic Cover Plates

PART NO.	DESCRIPTION	
OR-40300270	OR-40300270	Single gang cover, 2.75" x 4.5"
OR-40300271	OR-40300271	Double gang cover, 4.5" x 4.5"



NOTE: Standard color for Stylistics Cover Plates is fog white. For other colors, contact sales.

Single Gang Stainless Steel TracJack Faceplates with Phone Studs

PART NO.	DESCRIPTION	
OR-403STJ1WP	OR-403STJ1WP	Holds one TracJack, 2.75" x 4.5"



NOTE : Not compatible with 2554 series wall phones.

TRACJACK® Undercover Wall Plate

NOTE: All Ortronics product dimensions are listed by width, height and depth unless specified otherwise.

OR-403TJUSG



TracJack Undercover Wall Plate

The TracJack® Undercover provides a protective housing for four center mount TracJacks with the ability to add an additional copper or fiber TracJack out the bottom. This single gang housing offers increased protection for connections in tamper sensitive environments.

PART NO.	DESCRIPTION
OR-403TJUSG	Single gang protective housing holds up to five TracJack modules, 5.58"H x 2.25"D x 2.74"W

TRACJACK Surface Mount Boxes

Ortronics® TracJack surface mount boxes are available to house from two to six TracJacks. Bases are easily installed with supplied screws or double-sided adhesive. Snap-on covers have recessed label fields. Boxes are ruggedly constructed from high impact thermo-plastic 94V-0 rated. Standard color is fog white. Compatible with Wire-mold 2700, 2800 and 2900 raceway series.



Surface Housings for TracJack

OR-404TJ2



OR-404TJ4



OR-404TJ2X2



OR-404TJ6



PART NO.	DESCRIPTION
OR-404TJ2	Holds two TracJacks, 2.59" x 2.27" x 1.20"
OR-404TJ4	Holds four TracJacks, 4.80" x 3.6" x 1.16" Note: Can mount directly to single gang recessed wall boxes. Includes one TracJack blank.
OR-404TJ2X2	Holds four TracJacks, jacks exit from both sides, 4.0" x 2.42" x 1.16"
OR-404TJ6	Holds six TracJacks, 6.98" x 4.33" x 1.16" Note: Includes internal storage ring for fiber and two TracJack blanks. Can mount directly to single or double gang recessed wall boxes.

TRACJACK® Furniture Bezels



NOTE: All Ortronics product dimensions are listed by width, height and depth unless specified otherwise.

Legrand | Ortronics offers TracJack® plates for most furniture systems. Plates easily snap mount into furniture, requiring no special tools. Plates are ruggedly constructed from high impact thermo-plastic 94V-0 rated.

IMPORTANT: Measure furniture openings to determine the correct plate.

Furniture Plates for TracJack

PART NO.	DESCRIPTION
OR-40300577-00	
OR-40300576-00	
OR-40300575	
OR-40300633-00*	
OR-42100009	
OR-42100054-00	
OR-40700071	
OR-40700072*	
OR-40700073*	
OR-40300577	Holds four TracJacks, fits Herman Miller Beltline furniture openings 2.35" x 3.41" (+.015) for .125" thick material, fog white
OR-40300577-00	Black
OR-40300576	Holds six TracJacks, fits Herman Miller Beltline furniture openings 2.35" x 3.41" (+.015) for .125" thick material, fog white
OR-40300576-00	Black
OR-40300575	Holds six TracJacks, fits Herman Miller Baseline furniture openings 1.89" x 2.99" (+.015) for .063" thick material, fog white
OR-40300575-00	Black
OR-40300633*	Holds four TracJacks, two-piece base and cover, adjustable to fit a range of common furniture openings (2.67"-2.75" x 1.34"-1.41") for .065" thick material, fog white
OR-40300633-00*	Black
OR-42100009	Adapter plate, front-loads three TracJacks, fog white
OR-42100009-00	Black
OR-42100054	Adapter plate, rear-loads three TracJacks, fog white, five pack
OR-42100054-00	Black, five pack
OR-40700071	.125" deep bezel mounts adapter plates above to 2.71" x 1.38" (+.035) opening, fog white
OR-40700071-00	Black
OR-40700072*	.625" deep bezel mounts adapter plates above to 2.71" x 1.38" (+.035) opening, fog white
OR-40700072-00*	Black
OR-40700073*	1.0" deep bezel mounts adapter plates above to 2.71" x 1.38" (+.035) opening, fog white
OR-40700073-00*	Black

* Have recessed label fields

SERIES II® Modules

NOTE: All Ortronics product dimensions are listed by width, height and depth unless specified otherwise.

Ortronics® Clarity® Series II modules combine the improved performance of center tuned Category 6 or 5e connector technology with the ease and reliability of rugged, front-loading Series II modules with linear 110 termination.



Clarity 6 and Clarity 5E Enhanced Category 6 and 5e Series II Modules



PART NO.	DESCRIPTION
OR-S21600	Single enhanced Category 6 jack, 8-position, 180° exit, universal T568A/B wiring
OR-S22600	Dual enhanced Category 6 jack, 8-position, 180° exit, universal T568A/B wiring
OR-S215E00	Single enhanced Category 5e jack, 8-position, 180° exit, universal T568A/B wiring
OR-S225E00	Dual enhanced Category 5e jack, 8-position, 180° exit, universal T568A/B wiring

NOTE: Clarity Series II modules are available in -99 Wiremold® ivory, -88 white and -00 black. Icon compatible.

Additional Series II Jack Modules



PART NO.	DESCRIPTION
OR-S21RJ61	Single USOC RJ61 jack, 8-position, 180° exit
OR-S22RJ61	Dual USOC RJ61X jack, 8-position, 180° exit
OR-S22RJ25-5E	Single RJ25 USOC 6-position jack, single T568A/B Category 5e, 8-position jack, 180° exit
OR-S21RJ25	Single USOC RJ25 jack, 6-position, 180° exit
OR-S22RJ25	Dual USOC RJ25 jack, 6-position, 180° exit

NOTE: See page 194 for Fiber Series II modules

SERIES II® Modules

- See page 194
- for Series II
- Fiber modules

NOTE: All Ortronics product dimensions are listed by width, height and depth unless specified otherwise.

Additional Series II Connector Modules



PART NO.	DESCRIPTION
OR-40300144	Blank module, .5 unit
OR-40300164	Blank module, 1 unit
OR-40300191	Blank modules, 1 unit, package of ten
OR-40300023	Blank module, 1.5 units
OR-40300656	Series II angled bezel, accepts two flat TracJack modules, ten pack, 1.5 units

SERIES II Faceplates

Legrand | Ortronics offers single and double gang Series II plastic faceplates with a variety of port capacities to match your workstation applications. Series II plates offer recessed label fields, slotted screw holes to adjust alignment, and are ruggedly constructed from high impact thermo-plastic 94V-0 rated to ensure long life.

Single Gang Plastic, Double Gang Plastic and Angled Series II Faceplates



PART NO.	DESCRIPTION
OR-40300158	Single gang plastic, low profile, .5" deep, fog white, 2.75" x 4.5"
OR-40300011	Single gang plastic, standard profile, .75" deep, fog white, 2.75" x 4.5"
OR-40300159	Double gang plastic, standard profile, .75" deep, fog white, 4.5" x 4.5"
OR-40300175	Double gang plastic, high profile, 1.65" deep, fog white, 4.5" x 4.5"
OR-40300664	Angled, single gang faceplate holds two 1 unit modules, 4.5" x 4.5"

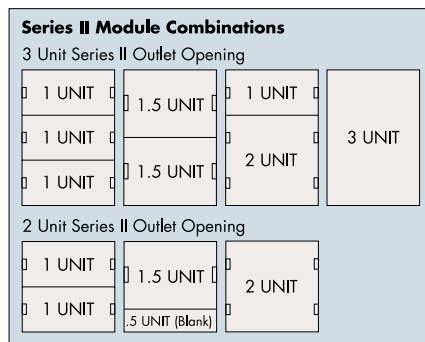

*Available in Wiremold ivory

SERIES II Surface Mount Interface Boxes

NOTE: All Ortronics product dimensions are listed by width, height and depth unless specified otherwise.

Ortronics® Series II surface mount boxes are available to house one to four 1-unit modules. Bases are easily installed with supplied screws or double-sided adhesive. Snap-on covers have recessed label fields. Series II surface mount boxes are ruggedly constructed from high impact thermo-plastic 94V-0 rated. These surface mount boxes work with 180° modules only. Compatible with Wiremold 2700, 2800 and 2900 raceway series.



Surface Housings for Series II

PART NO.	DESCRIPTION
OR-404S21U	OR-404S21U
OR-404S22U	OR-404S22U
OR-404S21X1U	OR-404S21X1U
OR-404S23U	OR-404S23U
OR-404S22X2U	OR-404S22X2U



PART NO.	DESCRIPTION
OR-404S21U	Holds one 1-unit Series II module, fog white, 2.27" x 2.59" x 1.20"
OR-404S22U	Holds two 1-unit Series II modules, fog white, includes one Series II blank, 3.60" x 4.80" x 1.16"
OR-404S21X1U	Holds two 1-unit Series II modules, fog white, includes one Series II blank, 4.00" x 2.42" x 1.16"
OR-404S23U	Holds three 1-unit Series II modules, internal fiber storage ring, fog white, 4.33" x 6.98" x 1.16"
OR-404S22X2U	Holds four 1-unit Series II modules, fog white, includes two Series II blanks, 4.00" x 4.71" x 1.16"

NOTE: Does not accept 45° modules.

SERIES II Furniture Plates

NOTE: All Ortronics product dimensions are listed by width, height and depth unless specified otherwise.

Legrand | Ortronics offers a wide selection of Series II plates for the many furniture systems available today. Plates easily snap mount into furniture, requiring no special tools. Plates are ruggedly constructed from high impact thermo-plastic 94V-0 rated.

IMPORTANT: Measure furniture openings to determine the correct plate.



Furniture Plates

PART NO.	DESCRIPTION
OR-40300196	OR-40300196
OR-40300213	OR-40300213
OR-40300167	OR-40300167
OR-40300196-00	OR-40300196-00
OR-40300213	OR-40300213
OR-40300167	OR-40300167
OR-40300167-09	OR-40300167-09

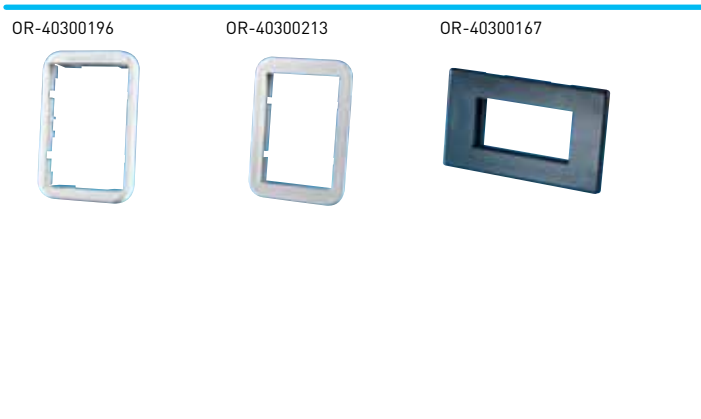

OR-40300196	Holds three 1-unit Series II modules, fog white, fits Herman Miller Baseline furniture openings 1.89" x 2.99" (+.015) for .0625" thick material
OR-40300196-00	Black
OR-40300213	Holds three 1-unit Series II modules, fog white, fits Herman Miller Beltline furniture openings 2.35" x 3.41" (+.015) for .125" thick material
OR-40300167	Holds one 1-unit Series II modules, black, 2.7" x 1.375" (+.03) for .090" thick materi
OR-40300167-09	Fog white

AUDIO | VIDEO CONNECTIVITY

Series II® Solutions

NOTE: All Ortronics product dimensions are listed by width, height and depth unless specified otherwise.

The Legrand | Ortronics range of audio, video, and data connectivity options offers you the flexibility, modularity and application density needed to support a wide variety of A/V equipment. Ortronics modules are available in our Series II®, TracJack®, and TechChoice® (keystone) footprints. We also offer a wide selection of connector termination styles and module colors.

IMPORTANT: Measure furniture openings to determine the correct plate.



Series II® Solutions

Series II® footprint provides the broadest range of options for data and A/V connectivity. It's ideal for larger A/V connectors such as VGA and combination modules which have both audio and video together. Series II also supports TracJack and keystone footprints through the use of an adapter bezel.



PART NO.	DESCRIPTION
OR-60900372	HDMI, female to female, 19pin, 1unit
OR-60900376	VGA 15pin, female to female, 1unit
OR-60900375	VGA 15pin, female to screw term, 1unit
OR-60900313	VGA 15pin, female to crimp pins, 1unit
OR-60900225	S-Video to 110, 1unit
OR-60900378	S-Video w/ 3.5m to 110, 1unit
OR-60900379	S-Video w/ RCA red, white to 110, 1unit
OR-60900212	2 RCA 1-white 1-red female to female, 1unit
OR-60900235	3 RCA red, white, yellow to 110, 1unit
OR-60900314	2 RCA 1-red 1-white female to 110, 1unit
OR-60900315	2 RCA 1-red 1-white, female to solder, 1unit
OR-60900316	3 RCA white, red, yellow female to female, 1unit
OR-60900373	3 RCA red, green, blue female to female, 1unit
OR-60900374	3 RCA red, green, blue to 110, 1unit
OR-60900273	3.5mm, stereo jack female to female, 1unit
OR-60900381	Speakon, 4pin male to solder, 1.5unit
OR-60900382	XLR, 4pin female to screw term, 1.5unit
OR-60900380	Binding post, red, black pair, 1unit
OR-60900377	Serial 9pin, female to female, 1unit
OR-60900017	F Conn 75 ohm, female to female, 1unit
OR-60900018	BNC 75 ohm, female to female, 1unit
OR-60900019	2 BNC 75 ohm, female to female, 1unit
OR-60900020	2 F Conn 75 ohm, female to female, 1unit
OR-60900073	F Conn 75 ohm, angled, female to female, 2 unit
OR-KSS2210	Series II bezel, 2port, keystone opening, 1unit, 10pk
OR-40300749	Series II bezel 2port, tracjack openings, 1unit, 10pk

Compatible with Legrand/Wiremold
 Legrand | Ortronics connectivity can be integrated into a full line of poke-thru devices, work surface portals, floor boxes, raceway systems, and architectural columns for seamless A/V integration on the wall, work surface, conference table, in floor, or vertically in open spaces.



AUDIO | VIDEO CONNECTIVITY

TracJack Solutions

TracJack® Solutions

TracJack footprint is front loading and supports a number of A/V and data modules. It's ideal for combining A/V with our high performance Clarity workstation products. The TracJack footprint can also be used with Series II through the use of an adapter bezel.



PART NO.	DESCRIPTION
OR-63700058	RCA red female to female
OR-63700086	RCA green, female to female
OR-63700085	RCA blue, female to female
OR-63700059	RCA white female to female
OR-63700060	RCA yellow female to female
OR-63700071	RCA red to 110
OR-63700083	RCA green to 110
OR-63700084	RCA blue to 110
OR-63700070	RCA white to 110
OR-63700047	RCA yellow to 110
OR-63700046	Pair of RCA to 110 (one red, one black), 180° exit
OR-63700025	S-Video to 110
OR-63700069	3.5mm stereo jack
OR-63700023	BNC 75 ohm, female to female
OR-63700006	F Conn 75 ohm, female to female
OR-63700087	F Conn 75 ohm, recessed, female to female
OR-63700021	Speaker term set, red, black pair
OR-42100002	Package of ten blanks

NOTE: Standard color for TracJack modules is fog white. Also available in -99 Wiremold ivory and -88 white. Contact Ortronics sales department for other colors.

AUDIO | VIDEO CONNECTIVITY

TechChoice® Keystone Solutions

TechChoice® Keystone Solutions

TechChoice® Keystone footprint is a rear loading style module that comes in a variety of A/V connector types as well as Category 5e and 6 data connectivity. It's ideal for creating a quality solution for A/V and data connectivity. The keystone footprint can also be used with Series II through the use of an adapter bezel.

OR-KSHDMI OR-KSSV OR-KSSVIDC



OR-KSRCAR OR-KSRCAG OR-KSRCABL



OR-KSRCAY OR-KSRCAW OR-KSRCAB



OR-KS35ST OR-KS35STST OR-KS14ST



OR-KSUBAA OR-KSUBAB OR-KSBP



OR-KSBNC75 OR-KSBNC OR-KSFCN



OR-KSFCNR OR-KSB10



PART NO.	DESCRIPTION
OR-KSHDMI	HDMI, female to female, 19pin
OR-KSSV	S-Video to 110
OR-KSSVIDC	S-Video, female to female
OR-KSRCAR	RCA red to 110
OR-KSRCAG	RCA green to 110
OR-KSRCABL	RCA blue to 110
OR-KSRCAY	RCA yellow to 110
OR-KSRCAW	RCA white to 110
OR-KSRCAB	RCA black to 110
OR-KS35ST	3.5mm, stereo jack, female to female
OR-KS35STST	3.5mm, stereo jack, female to screw term
OR-KS14ST	1/4" stereo jack, female to solder
OR-KSUBAA	USB 2.0 A-A, female to female
OR-KSUBAB	USB 2.0 A-B, female to female
OR-KSBP	Binding post, set of 2
OR-KSBNC75	BNC 75 ohm, female to female, 75 ohm
OR-KSBNC	BNC 50 ohm, female to female, 50 ohm
OR-KSFCN	F Conn 75 ohm, female to female
OR-KSFCNR	F Conn 75 ohm, recessed, female to female
OR-KSB10	Blank, package of ten

MULTIMEDIA WORKSTATIONS

NOTE: All Ortronics product dimensions are listed by width, height and depth unless specified otherwise.

Ortronics® Fib-or-Cop workstation solutions service a broad scope of multimedia applications, supporting sound cabling practices in an attractive and user-friendly design.



Fib-or-Cop II

Fib-or-Cop II offers greater capacity, accommodating up to 12 fiber connections with protected exit from the bottom, and six copper connections, either TracJack® or Series II®. This is a truly segregated design, which allows access to one media without impacting the other. Bottom-exiting connections can be further protected with an optional snap-on shroud.

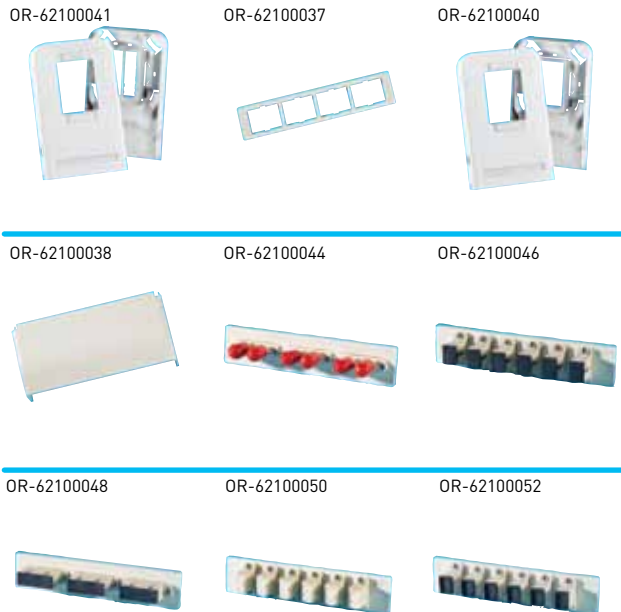

PART NO.	DESCRIPTION
OR-62100041	Base and cover for six TracJacks, 5" x 8" x 1.19"
OR-62100040	Base and cover for three Series II modules, 5" x 8" x 1.19"
OR-62100037	Package of five bottom adapter plates for four TracJack modules
OR-62100038	Package of five protective bottom shrouds
OR-62100044	3-ST duplex (6 fibers) multimode, beige adapters, phosphor-bronze alignment sleeves
OR-62100045	3-ST duplex (6 fibers) single-mode, blue adapters, ceramic alignment sleeves
OR-62100046	6-SC simplex (6 fibers) multimode, beige adapters, phosphor-bronze alignment sleeves
OR-62100047	6-SC simplex (6 fibers) single-mode, blue adapters, ceramic alignment sleeves
OR-62100048	3-SC duplex (6 fibers) multimode, beige adapters, phosphor-bronze alignment sleeves
OR-62100049	3-SC duplex (6 fibers) single-mode, blue adapters, ceramic alignment sleeves
OR-62100050	6-LC duplex (12 fibers) multimode, beige adapters, phosphor-bronze alignment sleeves
OR-62100051	6-LC duplex (12 fibers) single-mode, blue adapters, ceramic alignment sleeves
OR-62100052	6-MT-RJ (12 fibers) feed-through multimode, beige adapters
OR-62100053	6-MT-RJ (12 fibers) single-mode, blue adapters

MULTIMEDIA WORKSTATIONS

NOTE: All Ortronics product dimensions are listed by width, height and depth unless specified otherwise.

OR-JP66U

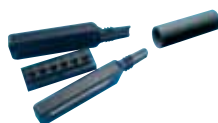

Clarity 6 and Clarity 5E Jak-Paks

The Jak-Pak is a compact, flexible, multi-user solution that can be structurally mounted or used in more temporary environments. Kits come supplied with Clarity 6 or Clarity 5E six-port/110 modules.

PART NO.	DESCRIPTION
OR-JP66U	Clarity 6 Jak-Pak, six-port multi-access outlet field termination kit, T568A/B
OR-JP5E6U	Clarity 5E Jak-Pak, six-port multi-access outlet field termination kit, T568A/B

OR-60950301



MUTOA Mac-Pak

The MUTOA Mac-Pak is a compact, flexible, multi-user solution that can be structurally mounted or used in more temporary environments. Kits come ready to accept flat Category 5e and 6 TracJack® modules and cables.

PART NO.	DESCRIPTION
OR-60950301	Accepts eight TracJacks, black housing

Multimedia Outlet (MMO)

Ortronics® Multimedia Outlet (MMO) is a high capacity, field configurable workstation housing. The MMO comes with three blank panels with cable access knockouts. A wide range of MMO panels are available to support your specific applications. MMO mounts directly to any single or double gang recessed wall box or to any surface. Labeling is supplied.

OR-62100001

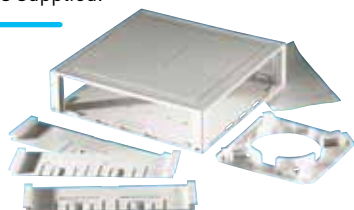

PART NO.	DESCRIPTION
OR-62100001	Cover base and three blank panels, 6.75" x 6.75 x 1.68", fog white

MMO Panels

OR-41200004

OR-41200010



OR-41200012

OR-42100009

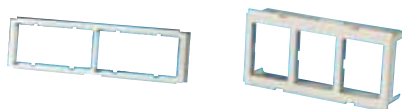

PART NO.	DESCRIPTION
OR-41200004	Accepts two 1-unit Series II® modules
OR-41200010	Accepts one fiber adapter panel, see fiber section
OR-41200012	Accepts two OR-42100009 TracJack® adapters
OR-42100009	Accepts three TracJacks

ACCESSORIES



NOTE: All Ortronics product dimensions are listed by width, height and depth unless specified otherwise.

Surface Mount Outlet Boxes

Ortronics surface mount outlet boxes are compatible with all Ortronics single and double gang faceplates. These boxes provide a mounting surface for faceplates or can be attached to recessed boxes to provide greater cable storage capacity.

OR-40300061

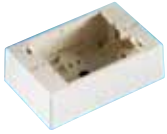

OR-40300185-13

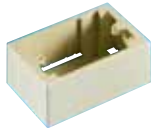

OR-70900020

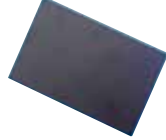

OR-40300186

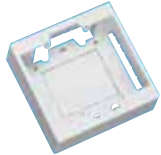

OR-70900022

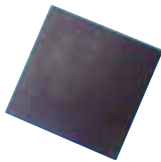

OR-70700070

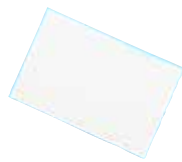

PART NO.	DESCRIPTION
OR-40300061*	Single gang, low profile, fog white, 3" x 4.7" x 1.5"
OR-40300185*	Single gang, fog white, 3" x 4.7" x 2"
OR-40300185-13*	Electrical ivory
OR-70900020	Adhesive-back single gang magnet
OR-40300186	Double gang, fog white, 4.9" x 4.7" x 2"
OR-70900022	Adhesive-back double gang magnet
OR-70700070	Double-sided adhesive kit (use two for double gang)

*Compatible with Wiremold® 2700, 2800 and 2900 raceway series.

OR-40300010



Extension Plate

Ortronics extension plate provides an additional .9" of depth behind single gang faceplates for bend radius requirements or cable storage.

PART NO.	DESCRIPTION
OR-40300010	Single gang extension plate, fog white, 2.75" x 4.5" x .9"

LABELING AND DESIGNATION SOLUTIONS

OR-70400411



Work Outlet Station Designation

Color-coded designation strips provide easy identification for workstations. Designation strips are supplied in 8.5" x 11" sheets of laser feed paper.

Supported by the LabelMo XL templates.

LabelMo XL Labeling Templates

The LabelMo XL templates provide a new format for your labeling needs that increases flexibility and ease of use.

- Provided in an easy-to-use Excel format
- Uses our standard 8.5" x 11" label stock

PART NO.	DESCRIPTION
OR-70400411	White
OR-70400411-22	Red
OR-70400411-23	Orange
OR-70400411-24	Yellow
OR-70400411-25	Green
OR-70400411-26	Blue

NOTE: Ten sheets per package, 96 labels per sheet.

PART NO.	DESCRIPTION
OR-70400202	Workstation, replacement designation label/cover kit, package of ten

OR-70400219



Jack Designation Tabs

Ortronics® Jack designation tabs snap into Series II modules and TracJacks to identify each port. Accommodates two one-port modules. Standard color is fog white. Package of 12.

PART NO.	DESCRIPTION
OR-70400219	Jack designation tabs

Color-Coded Icons



Color-Coded Icons

Ortronics color-coded designation tabs are for port identification on patch panels and most workstation products. The tabs are available in 606 standard colors with a voice or data icon or blank. Package of 100.

OR-403	XX	X	00	
Manufacturer Number	Coloring		Marking	
	00=Black	23=Orange,	1=Voice	Ordering example: To order a red voice tab, use the following part number OR-40322100
	22=Red	25=Green,	2=Data	
	24=Yellow	27=Purple,	5=Blank	
	26=Blue	09=Fog White,		
	13=Electrical Ivory			

NOTE: For a complete set of voice and data tabs in all colors, use order number OR-40300174.