

# 2010 Product Line Catalog



Access Systems

Stand Alone Access Control

Electronic Access Control /Locksets

Intrusion Detection



---

## Order Information

### Sales Department

5:00 AM — 4:30 PM (Pacific Time) Monday – Friday

8:00 AM — 7:30 PM (Eastern Time) Monday – Friday

**Phone** 1.800.421.1587

**Fax** 1.800.468.1340

**Web** [www.linearcorp.com](http://www.linearcorp.com)

**E-mail** [sales@linearcorp.com](mailto:sales@linearcorp.com)

### Technical Support for Dealers & Installers

5:00 AM — 4:30 PM (Pacific Time) Monday – Friday

8:00 AM — 7:30 PM (Eastern Time) Monday – Friday

**Phone** 1.800.421.1587

**Fax** 1.760.438.7199

**Web** [www.linearcorp.com](http://www.linearcorp.com)

**E-mail** [techsupport@linearcorp.com](mailto:techsupport@linearcorp.com)

These Linear products are available nationwide at hundreds of conveniently located local distributors branches. The innovative products are available where you need them and when you need them, making Linear the natural choice for your security solutions.

Linear products are distributed by:

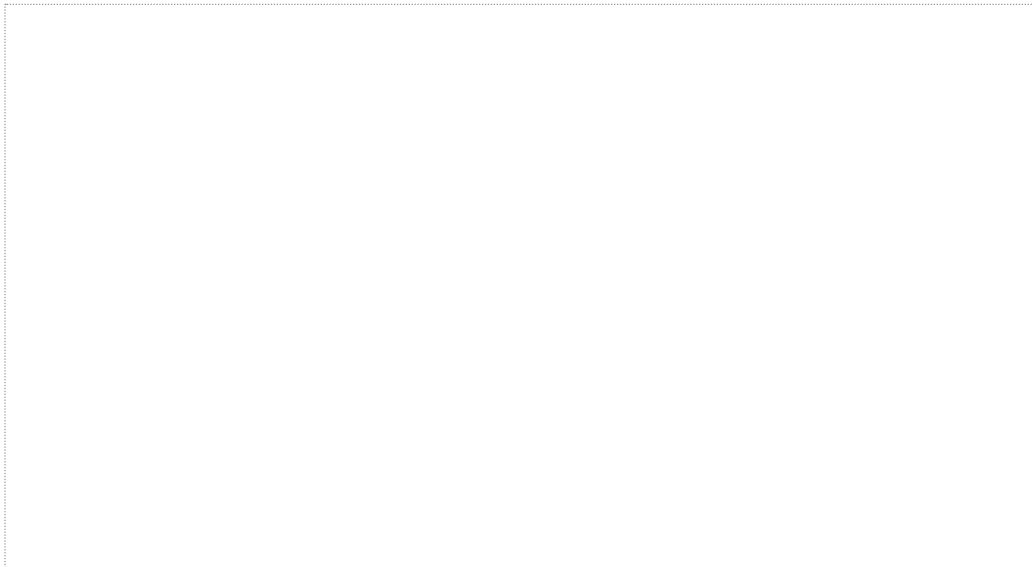

All these brands are now under one name.



---

## An Innovative History



Linear was established in 1961 as a manufacturer of radio controls. Over the next five decades, an unrelenting dedication to quality has turned it into the most trusted name in everyday technology.

Long known for pioneering radio frequency in everyday use, Linear now combines passive infrared detection, digital electronics, and human engineering for a full range of products. Today, Linear opens your gates, your garages, and your front doors. You walk through Linear. You talk through Linear. You trust Linear every day.

Linear's prevalence across America is simply unprecedented. Hundreds of thousands of people use Linear products every day without even knowing it. Backed by the industry's best warranties, a network of qualified integrators and installers, and unrivaled electronic solutions know-how, it's no wonder that Linear continues to lead the industry forward.

Linear combines the latest in technology with simplicity and elegance. From gate operators to intercom systems to high-definition video distribution, these are innovations that are designed to make your life easier. These are innovations that make your life better.

Linear LLC, a market innovator in RF remote controls, access control and wireless security systems for residential and commercial applications, announces the completed transition of all business operations of International Electronics, Inc. (IEI) to Linear's headquarters in Carlsbad. IEI, formerly based in Canton, Massachusetts, has been a leading manufacturer of electronic products for more than 30 years. Evolving to leverage both technology advances and the Internet, IEI's product lines include access control solutions for single doors, PC based networked systems and embedded browser based integrated access control security management systems.

---

## About International Electronics, Inc.

For 30 years, IEI has built its reputation based on trusted products and responsiveness to customers. With a range of access control solutions, including the market leading line Door-Gard™ stand alone keypads, Secured Series™ Access Systems and now with the eMerge™ Browser Managed Security Platform, Linear's IEI brand offers customers the right solution for their application and combines that solution with a commitment to excellence in service and support.

IEI brand **Access Systems** include: eMerge, a browser-managed security platform with no system software to install; Secured Series, a choice of PC-based systems consisting of Max 3, MiniMax 3, and Prox.Pad Plus using Hub Manager Professional Software.

IEI brand **Stand Alone Access Control** devices include a wide range of keypads and readers for nearly any environment, performance requirement, functionality and design consideration. With an additional host of optional components and accessories, Linear can provide you with the necessary equipment to complete your access control system.

When a traditional lock and key is not a viable option for access control, the IEI brand provides the LS Series **Electronic Access Control Locksets** that are simple to install, provide added protection, and can be used as either a card access, code entry or a combination of the two to provide an increased level of security.

IEI brand **Intrusion Detection** products, which include vibration detection and panel interface keypads are used to detect undesired activity in a location. These products are used in conjunction with a burglar alarm or security system.

As the terms network and internet protocol merge with security, Linear understands the continued demands for providing products that combine the highest quality standards for workmanship with ease of use; for delivery to its customers products that meet their applications and can scale with it, and providing a continuing commitment to excellence, service, and support.



Access Systems 2

Stand Alone Access Control 24

Electronic Access Control  
Locksets 38

Intrusion Detection 48



# ACCESS SYSTEM

From enterprise-wide security management to small and mid-size access control, Linear's IEI brand has a choice of Access Systems, giving you the freedom to design a solution that truly matches your needs. Regardless of the complexity of your environment, these Access Systems are easy to install and easy to use.

Scalable. Reliable. Intuitive. Every IEI brand Access System ensures that security personnel can easily access and respond effectively to events. The systems are designed to grow as your requirements expand.

Manage the entry and exit activity to your facilities with our line of Access Systems. The range of products include eMerge with no software to install, PC Based panel systems that are secure and centrally managed, and small proximity single-door systems. We offer a choice of system solutions for every access control application.

Embedded Software Systems	4
eMerge Access Control Platform	6
eMerge Integrated Security Platform	8
PC Based Access Systems	13
Max 3 Access System	14
prox.pad plus	16
Access System Keypads and Readers	20
Access Systems Summary	22

## System Choices

Criteria

	eMerge 5000 Integrated Security Platform	eMerge 50 Access Control Platform	Secured Series Max 3	Secured Series MiniMax 3	Secured Series prox.pad plus
System management	Browser based	Browser based	Multiple PC	Multiple PC	Multiple PC
Control	Programmable outputs, expandable outputs & real time door control	Programmable outputs, expandable outputs & real time door control	Basic I/O with 4 outputs & real time door control	Basic I/O with 4 outputs & real time door control	Basic I/O with 2 outputs
Monitor	Menu of reports & queries, Live transactions	Menu of reports & queries, Live transactions	Menu of reports Realtime door status & transaction	Menu of reports Realtime door status & transaction	Standard reports
Reader	Any wiegand, multiple formats	Any wiegand, multiple formats	Any wiegand, multiple formats	Any wiegand, multiple formats	Integrated Proximity & Keypad
Doors per site	140	32	64	64	32
Doors per system	140	32	128	128	128
Users per door	20000	5000	2000	2000	2000
Users per system	20000	5000	20000	20000	20000

## Browser Managed Security With No Software Installation

eMerge is Linear's Integrated Security Management System with embedded software. It combines powerful systems integration with an easy-to-use web browser interface. The Linux operating system, Postgre SQL database and web server, all embedded in the eMerge solid-state platform, make it both easier to use and more powerful than legacy access control and security systems. eMerge employs state-of-the-art encryption and authentication technology to ensure secure communications. Standard industry wiring is employed throughout the system.

eMerge is a network appliance that IT managers approve. Everything you need to install and manage the system is embedded within the Network Controller. There's no server software, no client software, no gateways, no new communication wiring to install, no plug-in hardware adapters for connectivity and no software compatibility issues to deal with. All which ensure lower long-term cost of ownership compared to other systems.

### eMerge Advantages:

No software installation – Everything you need to run the system is included in the system controller so there are no server or computer conflicts to deal with.

- Browser managed – Access and manage your system security from anywhere in the world with a standard browser interface and web connection
- Embedded applications – All software and databases are embedded in the panel, including Postgre SQL database and web server, resulting in ease of use and installation
- Communications over existing LAN/WAN networks – eMerge uses the Internet via easy to obtain, inexpensive equipment commonly found in most offices.



### Network Topography

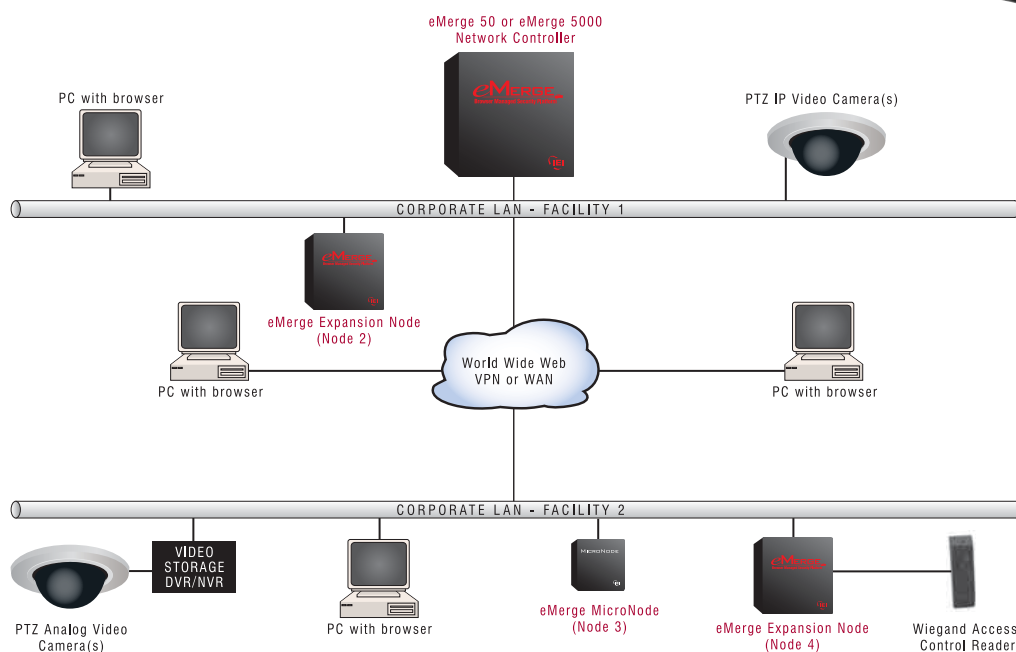

## eMerge System Features and Benefits

	eMerge 50 Access Control Platform	eMerge 5000 Integrated Security Platform
e-mail and SMS, LDAP Authentication	Yes	Yes
NAS back-up	Yes	Yes
Burg interface	Yes	Yes
User photo	No	Yes
Video Management System	No	Option
Live Monitoring Bundle Monitoring desktop, floor plans, alarm acknowledgement, Photo pop-up	No	Yes
Anti-Passback	No	Yes
Photo ID	No	Option
Elevator control	No	Yes
Threat levels	No	Yes
Visitor Management System	No	Option
Alarm panel interface	Yes	Yes
API with data management tool	Yes	Yes

### Hardware and Software Specifications

Readers:	The IEI eMerge Access Control Module supports readers and keypads that use the Wiegand Reader Protocol
Operating System:	Red Hat Linux
DBMS	Postgre SQL, ODBC
e-mail Support:	POP, SMTP
Encryption:	SSL, SHA-1
Network:	NTP, TCP/IP
Web:	http, https, xml
Processor:	Intel XScale-IXP425
Can Dimensions:	17" x 18" x 6 3/4"
MicroNode Dimensions:	7" x 7" x 3.5"
UL Standards:	UL 294 Listed

### Network Controller

Is the central control mechanism of the system, replacing older PC-based systems. The controller included a full version of Linux, a web server, ODBC-compliant Postgre SQL database server and embedded software within the Intel processor.

### Expansion Nodes & MicroNodes

Allow eMerge to communicate across a LAN, WAN or the web. Each Expansion Node contains a Node Card that communicates securely with the Network Controller and manages all application functions within the Node for fail-to-the-Node operation.

### Application Modules

Can customize a security panel with the components you want and where you need them. Up to 7 application modules can be mounted within a Node that include; Access Control Modules with Wiegand protocol card reader inputs. Supervised Input Modules, Relay Output Modules and Temperature Monitoring Modules.

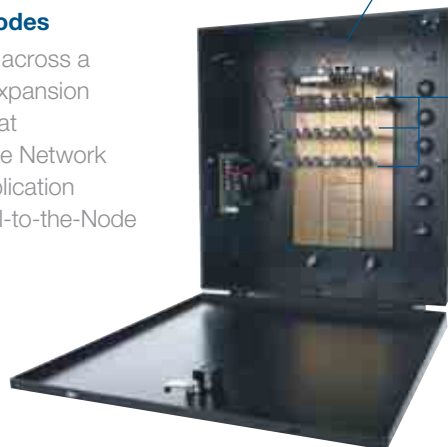

## eMerge Access Control Platform

The entry-level system that is easy to use and easy to install. It contains all the powerful advantages of the eMerge platform, but in a smaller user configuration and without the advanced monitoring and video management bundles and other high-level features. It can be easily upgraded to grow with clients needs with no change in hardware.

Easy and complete management of all system users is accomplished from one screen including access levels, card assignments, photo ID, personal information and password protected access.



## eMerge 50 Access Control Platform Features

The Integrated Security Platform contains the highlighted features below plus all the features and benefits of the Access Control Platform

### Alarm Panel Interface

eMerge can integrate with your burglar alarm panel to arm or disarm the burglar system when authorized access has been granted to your facility. You can program eMerge to automatically arm your burglar system if the facility has been left unsecured for a predetermined amount of time. You can also remotely arm or disarm the burglar system through eMerge.

### Network Attached Storage (NAS) Back-Up

eMerge can create database backups each night to be stored in ROM onboard the network controller and written to Network Attached Storage. The system administrator also has the ability to create database backups at any time as well as to download to off board storage at any time. A restore of the database from a backup can be made from a backup copy on the network controller. It is therefore possible to upload a copy of a database backup from any Network Attached Storage. eMerge allows system administrators to review backups by date and description as well as to select the desired backup for upload to the network controller or restoration of the current database.

### e-mail and Short Message Service (SMS)

eMerge supports the use of e-mail notifications of alarm events. Once the system administrator sets up the e-mail server IP address or DNS name and the e-mail address of the network controller, specified users can be notified of any alarm activity. It is also possible to enter a name and a description in the system for each alarm event.

### Interactive Reports

An easy to use query language makes the creation of ad hoc reports simple and easy. Users can produce a variety of predefined reports regarding software and security hardware configuration, event history, and the administration of people within the system. Report generation does not affect the real-time operation of the system.

### Remote Service

The network architecture and browser interface of eMerge allows users to easily configure and service the system from in the building, across town, or across the country, using any computer with a web browser. Remote service is now a reality, permitting your service technician to troubleshoot a system without needing to travel onsite to the installation.



### Access Control

The primary purpose of eMerge is to provide access control. All standard access control parameters are easily created and managed in a single view. System administrators can make access control decisions, define a variety of access levels and time specifications, write system activity into a log file, maintain a personnel enrollment database, receive signals from input devices such as door switch monitors, card readers and motion detectors, energize devices such as door locks and alarms via outputs, and provide on-screen monitoring features.



### Interactive Reports

The Access Control Platform of eMerge includes many predefined reports, along with an easy-to-use interface for generating custom reports. The proprietary English-based freeform report language makes the retrieval of specific information easy for inexperienced users. Other reports are even easier to specify, and many require no typing at all. Emerge 5000 offers a custom report writer.



### Easy Network Set-Up

IT managers are comfortable with eMerge because it is designed to work in their environment. A few pieces of information are all that are needed to put eMerge into action. Network node reports display all nodes in the system with IP addresses and UID (unique ID).

### eMerge 50 Parts and Order Numbers

Model	Order Number	Description
eMerge 50	230219	eMerge 50 System
eMerge EXN	230221	eMerge Expansion Node
MicroNode	230222	eMerge MicroNode

A wide array of eMerge add-on software licenses for live monitoring, video management, badge printing and other system peripherals and supplies are available. Call Linear Customer Service or contact an authorized eMerge dealer for specific information, part numbers, and order numbers.

## eMerge Integrated Security Platform

Able to handle a broad range of security management functions, including live monitoring, photo ID, elevator control, threat levels, video management, alarm panel interface, data interchange, regional anti-passback, LDAP authentication, roll call reporting, and visitor management. Installations of the eMerge Integrated Security Platform range in size from small, stand-alone facilities to distributed enterprises of remote sites.

### Monitoring Desktop

Items in the event log marked with the camera icon, have associated stored video. Hovering on the camera with the mouse, displays which cameras are recorded. Clicking on the camera replays the stored video.



## eMerge 5000 Integrated Security Platform Features

### Video Management System

The eMerge Video Management System offers high-end video handling capabilities with live and stored video playback in a small, scalable package. The system playback analog cameras with DVR's and IP cameras all simultaneously. All devices are network connected, and can be accessed with a common web browser. Because it runs on eMerge, no PC server is required.

### Live Monitoring Bundle

Includes monitoring desktop, floor plans, alarm acknowledgement, and photo pop-up.

### Photo-ID

Enables users to easily capture images and add text to create personalized custom cards or access credentials such as proximity, barcode and magstripe cards. Since Photo-ID is integrated with eMerge, a single database exists that captures all information from the access system, including access definitions and photos.

### API - Data Interchange

The eMerge API capability is an open platform with readily available API's and data security built into the communications architecture. eMerge API manages it's transactions through a web service that communicates using XML data packets with embedded authentication codes. The data migration tool allows import of personnel data from other systems requiring no additional programming.

*(Also available with eMerge 50)*

### Temperature Monitoring

eMerge integrates dynamic temperature monitoring using the floor plan within "Monitoring Desktop" via interactive icons. Alarm triggers are set to indicate areas that are outside determined acceptable temperature levels. The user can choose to set the unit up to provide results in either a Fahrenheit or Celsius scale. Historical results are provided in a report or can be displayed graphically over a customizable time period.

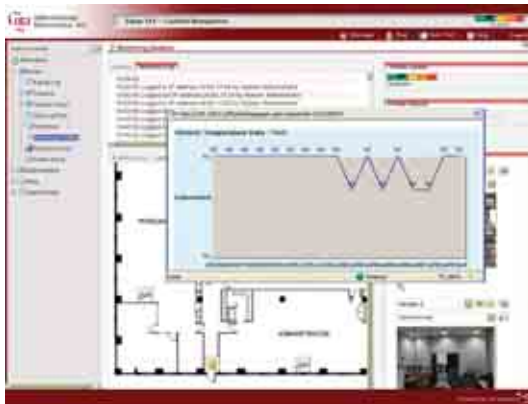

### Real-time Monitoring

Monitoring Desktop, available with the Integrated Security Platform of eMerge, allows real-time monitoring of critical system functions, including interactive floorplan, live event log, event acknowledgment, video monitoring, user image verification and control of doors.

### Temperature Monitoring

eMerge integrates dynamic temperature monitoring. Historical results are displayed graphically.



### Live Video Monitoring

The Integrated Security Platform of eMerge allows real-time video to be viewed. Cameras can be viewed individually, in quad views or picture-in-picture format. Cameras at different locations can easily be managed by the system and combined for viewing on a single screen. Camera pan, tilt, and zoom can also be controlled through the user interface.



### Threat Level Management

System parameters and business rules can be quickly changed with one click using Threat Level Management, a feature in the Integrated Security Platform. A change in the threat level results in a change in the behavior of the security system, including portal unlock behavior, alarm event actions, function of access levels, control of doors and access privileges. A system administrator can configure threat levels, define behavioral changes based on the threat level, and set the current threat level. Threat levels are also changeable in response to alarm events.

### eMerge 5000 Parts and Order Numbers

Model	Order Number	Description
eMerge 5000	230220	eMerge 5000 System
eMerge EXN	230221	eMerge Expansion Node
MicroNode	230222	eMerge MicroNode

A wide array of eMerge add-on software licenses for live monitoring, video management, badge printing and other system peripherals and supplies are available. Linear also offers eMerge professional services for assisting system design and deployment. Call Linear Customer Service or contact an authorized eMerge dealer for specific information, part numbers, and order numbers.

## Max 3 Access System

The Secured Series Max 3 access system hardware with Hub Manager Professional software is “access simplified”. The Max 3 is powerful and easy to install and program for small to mid-sized applications. The Max 3 system provides a secure and trusted access control system that uses proven hardware architecture that is based upon the Secured Series HubMax II system. System management from a PC can be either over a LAN/WAN connection or through a RS485 serial connection. All individual door access decisions and transaction events are stored at the Max 3 Module. The Max 3 Module is programmed via LAN, WAN, RS-485, MODEM or IR using the Hub Manager Professional Software. The Max 3 system is available in two cabinet configurations – Max 3 and MiniMax 3. System expansion is made simple with the modular design of the two available configurations. Up to 64 door modules can be networked together per site with virtually unlimited sites.

### Max 3 System Advantages:

- **Fast and Reliable Communications.** Industry standard RS485 communication can be used over either LAN/WAN, Serial, or Modem connections.
- **System Dashboard Utility.** A unique feature of Hub Manager Professional Software which allows operators to view the status and events of system doors, as well as lock or relock doors from a PC.
- **System Setup Tasklist.** Video tutorial and setup wizards that are available in a checklist user interface to indicate completed tasks.
- **Configuration Flexibility.** Accommodates single-door to multi-door installations. Multiple cabinet designs support distributed installations with Mini-Max 3 and home run installations with Max 3.



The **Max 3** cabinet configuration provides the simplest expansion of one to four doors per cabinet when the system needs to be installed in a central location.

The **MiniMax 3** configuration is ideal for applications where the doors are far apart and/or the control is located at the door.

### Easy Ordering Steps for Max 3 Systems

#### 1. Choose a Door Controller

*MAX 3 SYS, MINIMAX 3 SYS, MAX3MOD EX*

#### 2. Choose the Access Credentials

*Cards, Key Fobs, and Tokens*

#### 3. Choose a Communications Module

*SEG-1, SEG-M, IEI232-485 Converter, M3M Modem, or USB-Serial Converter*

## Hub Manager™ Professional Software

Hub Manager Professional Software is a powerful and easy to use solution. Fast and easy to use management reports meet the requirements of the commercial access control market. Hub Manager Professional Software uses “Access Levels” for construction of logical groupings of doors, sites, users and time zones. Building access levels, adding doors, creating users and setting system parameters are made easy with Hub Manager Professional’s setup wizards. With the ability to program and manage all current and legacy hardware platforms such as HubMax II, Max3, Hub MiniMax II, MiniMax3, prox. pad plus and the LS series locksets, Hub Manager Professional completes your access systems needs.

\*LAN/WAN connectivity requires the purchase of LAN/WAN device, part number SEG-1 or SEG-M. Modem connectivity requires the purchase of M3M Modem.



Version 8.0 of Hub Manager Professional is included with all Secured Series systems and kits, and with prox.pad Plus series of products and LS2 Series of products. It can also be downloaded free of charge from our website at [www.linearcorp.com/downloads.php](http://www.linearcorp.com/downloads.php). Version 8.0 is reverse compatible to all pre-existing Secured Series controllers.

### MAJOR FUNCTIONALITY

- Supported Operating Systems:
  - Windows Vista Business™*
  - Windows Vista Home Premium™*
  - Windows XP Home™*
  - Windows XP Professional™*
  - Windows Server 2003™*
  - Windows Server 2008™*
  - Windows Vista Business (Spanish Edition)™*
- Support the Max 3 Output Module (M3-OM), which adds 8 outputs per door
- Temporary User features
- Improved access level detail screen with each door edited separately
- Delete use feature
- Expanded time management reports

### ADDITIONAL NEW FEATURES & ENHANCEMENTS

- Selectable modem retries
- Selected installation directory, important for Latin America versions of Windows
- First-In auto unlock can be triggered by user
- DTD printer support – Data Transfer Device for LS & prox.pad Plus IR
- Faster data communication across IP networks

---

## PC Based Access Systems

The Networked PC Based Access Systems provide users with a wide range of features and installation choices. We address your access system needs with three flexible approaches – two panel systems and one small proximity solution. The **Max 3** is a panel system that allows for fast and easy expansion 4 doors at a time up to a maximum of 64 doors. The **MiniMax 3** is a panel system for single door control, yet has the capability to grow as your system requirements expand. The **prox.pad plus** is a small proximity solution that provides large system features in a self-contained controller. The prox.pad plus can be networked with other prox.pad plus controllers to a system capacity of 32 doors.

Each of our Networked Access Systems uses our Hub Manager Professional software package to expand the basic feature set and manage system doors and users.

---

## Max 3 Access Control System Kits

### MAX 3 SYS

- Max 3 single-door kit
- Max 3 oversized metal cabinet with lock
- One Max 3 door control module (DCM) installed
- Max 3 Backplane supports three additional DCMs
- One XF1050 AWID, HID, xCeedID, and Casi/ProxLite compatible proximity reader
- Includes system AC transformer
- Includes AC transformer and 12/24 VDC power supply for lock power
- Hub Manager Professional software
- Requires communication module

### MINIMAX 3 SYS

- MiniMax 3 single-door kit
- MiniMax 3 metal cabinet with lock
- Max 3 Door control module (DCM)
- One XF1050 AWID, HID, xCeedID, and Casi/ProxLite compatible proximity reader
- AC transformer
- Built-in 12 VDC 1 amp power supply
- Programming keypad
- Hub Manager Professional software
- Requires communication module

### MAX3MOD EX

- Max 3 single-door expansion kit
- Plugs into Max 3 backplane
- One Max 3 Door control module (DCM)
- One XF1050 AWID, HID, xCeedID, and Casi/ProxLite compatible proximity reader

# Choose the system for your application

## Centralized Configuration

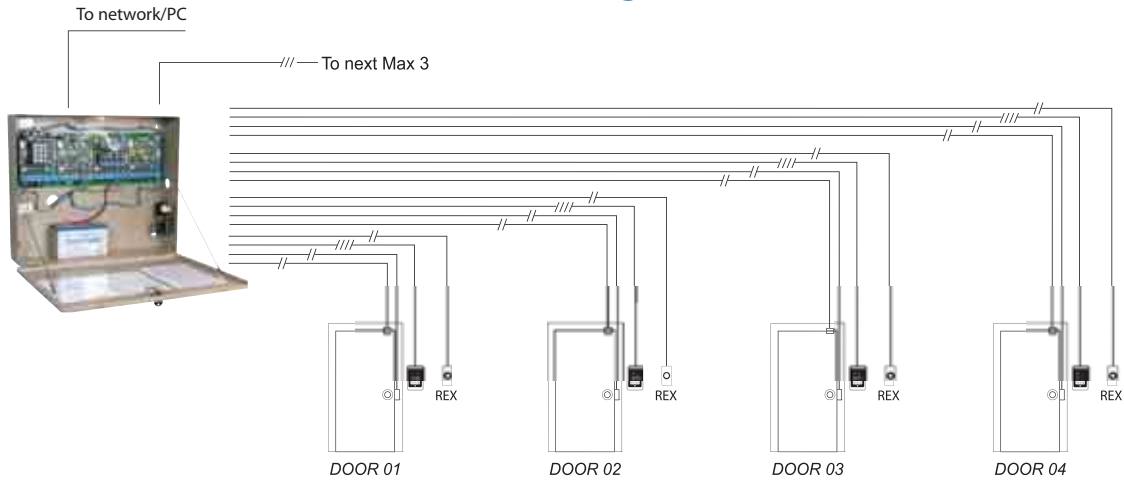

**Max 3** – The Max 3 cabinet is placed in a central “secure” location, and all wiring is run back from each door to the Max 3

## Distributed Configuration

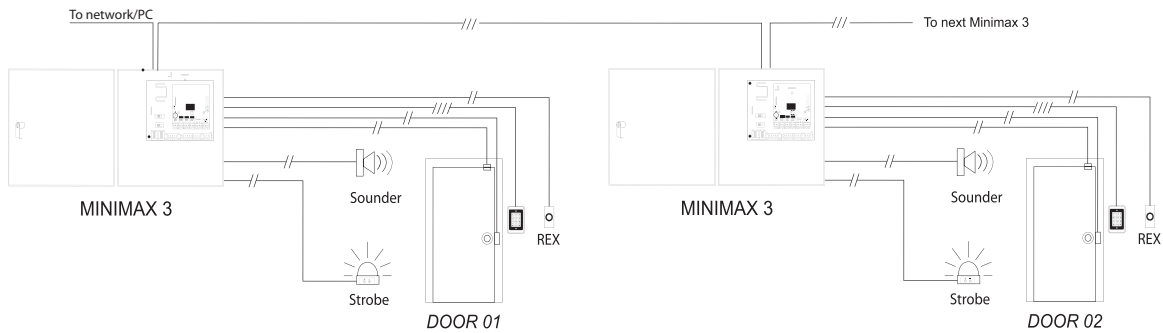

**Minimax 3** – Each Minimax 3 is located in close proximity to the door, reducing the wiring runs.

## Small Proximity “At the Door” Configuration

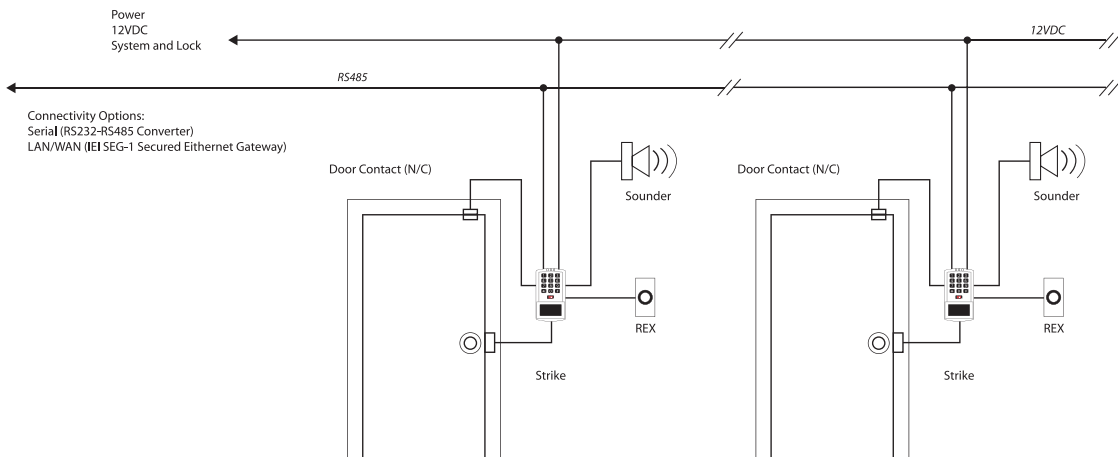

**prox.pad plus** – Each prox.pad plus is located at the door acting as the reader and the controller. The wire connections are made at each door.

**All three systems are compatible and hardware can be mixed and matched.**

## Max 3

Max 3 starts as a single-door access control system. With easy to install plug in Door Control Modules the system can expand as system requirements grow. Each Max 3 comes complete with a Max 3 backplane, one Max 3 Door Control Module, programming keypad, class II 16.5 VAC transformer and mounting enclosure. The backplane provides expansion slots for three more Max 3 Door Control Modules allowing for up to four modules per can.

## MiniMax 3

The MiniMax 3 contains the Door Control Module (DCM) for single door control that can be networked with other MiniMax 3 controllers or Max 3 controllers to expand your system up to a total of 64 doors. The MiniMax 3 backplane not only has the DCM pre-installed, it also contains a power supply for readers as well as for a door strike or magnetic lock (AC or DC). The enclosure dimensions are ideal for applications where the controller is installed at the door (e.g. above the ceiling over the door).

\*LAN/WAN connectivity requires the purchase of LAN/WAN device, part number SEG-1 or SEG-M. Modem connectivity requires the purchase of M3M Modem.

### FEATURES

- 2000 Users per door
- Network up to 64 doors
- Supports IEL system keypads & readers as well as Wiegand readers
- 2000 Transaction storage per door
- First-In Auto Unlock
- Eight Time zones per door
- 16 Single Date Holidays per door
- 16 Block Date Holidays per door
- Error Lockout
- Supports Adjustable Daylight Savings Time
- Programmable with Hub Manager Professional Software 7.2 or higher
- LAN/WAN Connectivity (requires SEG-1 or SEG-M)
- Serial connection made with USB to 485 converter



Max 3



### SPECIFICATIONS

- Operating Voltage: 16.5 VAC 40 VA Class 2 transformer
- Current Requirements: 100 mA (backplane & 1 module) add 40 mA for each module / MiniMax 3 - Current Requirements: 120 mA
- Front End Reader: 13.8 VDC 300 mA
- Main Relay: 12-24 VAC/DC 2 A
- Alarm Shunt, Door Ajar, Forced Door Outputs: 12-24 VAC/DC, 1 mA each
- REX/Door Loop: Dry contact closure
- Max 3 - Dimensions: 16.50" x 19.50" x 4.25" / MiniMax 3 Dimensions: 11.31" x 11.29" x 3.56"
- Temperature tolerance: -20F to 130F
- Indoor use only



MiniMax 3

## Max Module (Expansion for Max 3)

The Max 3 Door Control Module (Model Max3Mod) provides single door access control with a wide range of features and functionality. DCM's are added to the Max 3 cabinet for system expansion of up to 64 doors. The DCM comes installed in each MiniMax 3, and in the first bay of each Max 3 access system. All access and egress decisions are made at each DCM. When managed with Hub Manager Professional software, the DCM supports multiple access levels to control access. The position status of a door is monitored via a set of normally closed (NC) door contacts. Depending of the state of the door, the DCM will trigger a Forced or Propped door alert while recording that event in the transaction buffer. These transactions can be viewed with Hub Manager Professional to monitor each aggress and access point.

### FEATURES

- 2000 Users
- 2000 Transaction Event Buffer
- 8 Time zones
- 16 Holidays
- First-In auto unlock
- Supports two readers for one door in and out monitoring
- Forced/Propped Door
- Alarm shunt
- REX & Door monitoring inputs

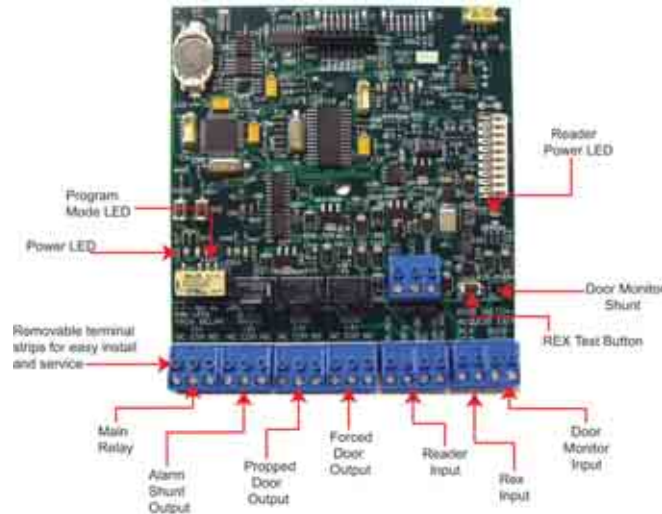

## Max 3 Output Module

The Max 3 Output Module (M3-OM) adds 8 form C control relay outputs to a Max 3 Module. The module enables Secured Series customers to handle a greater number of applications such as elevator control, handicapped door control, and controlling or triggering a camera or DVR upon a card read or PIN code. Version 8.0 or higher of Hub Manager Professional Software is required for the Output Module. The Output Module is compatible with the Max 3 v2 or higher controller.

Using the Max 3 Output Module will allow you to control multiple outputs for each Max 3 system user from any given reader or keypad. Hub Manager Professional Software will allow you to specify a custom name and timer value for each of the 8 outputs. Each output can be set to toggle or for timed operation. Any combination of these outputs can be assigned to user and the user will trigger these outputs when they gain access.

### FEATURES

- Adds 8 Form C Control relay outputs to a Max 3 Module
- Includes power LED and individual relay status LEDs
- Ability to specify a custom name and timer value for each of the 8 outputs
- Convenient "stackable" mounting to the Max 3 module
- Securely installs in Max 3 and MiniMax 3 cabinet
- Primary and back-up power from Max 3 or MiniMax 3 system
- Plug & Play design



# Small Proximity Access System

## prox.pad plus

Prox.pad plus is a fully integrated PC managed single door access system with a stand alone proximity reader and keypad. The prox.pad plus when used on it's own provides cost effective standard access control functionality with the use of it's two relays and two inputs for request to exit and door position, and enhanced system functionality when used with Hub Manager Professional software. The software allows the management of people and doors through easy to create reports and step by step wizard assisted expanded feature functionality. The software can communicate to the prox.pad plus either through a 485 connection, or on a LAN/WAN using the SEG-1 TCP/IP communication device. By utilizing the proximity reader and keypad together, a higher level of security is achieved by requiring both to grant access. The prox.pad plus can be directly mounted to a single gang electrical box or to most flat surfaces. The proximity reader is capable of being mounted up to a maximum of 10 feet away from the prox.pad plus.

\*LAN/WAN connectivity requires the purchase of the LAN/WAN device, part number: SEG-1

### FEATURES

- Integrated door control, proximity reader and keypad
- 2000 users
- 2000 event audit trail
- 32 doors per site (when managed with Hub Manager Professional)
- Bi-color LED to indicate operation
- Weather resistant design
- HID 26 – 40 bit format card compatibility
- HID Corporate 1000 compatible
- Fits over a single gang electrical box
- Communication via – SEG-1 (LAN/WAN) or USB to 485 converter
- Remote proximity reader mounting and glass mount option

### SPECIFICATIONS

- Dimensions: 2.75" x 5.25" x 1.38"
- Operating voltage: 12 VDC only
- Temperature tolerance: -31F to 150F
- Main relay: Form C 2 amp SPDT
- Auxiliary Relay: Form C 1 amp SPDT
- REX/Door Loop: Dry contact closure
- Indoor/outdoor use



*Remotely Mounted prox.pad proximity reader*

## prox.pad plus IR

Prox.pad plus IR with wireless Infra-red communication, is a fully integrated PC managed single door access system with a stand alone proximity reader and keypad. The prox.pad plus IR provides entry level to mid-sized access control functionality with the use of it's two onboard relays and two inputs for request to exit and door position monitoring. Enhanced system functionality is achieved when managed with the Hub Manager Professional software. The software allows the management of people and doors through fast and easy report creation and step-by-step wizards that assist in adding expanded feature functionality.

### FEATURES

- Integrated HID proximity reader and keypad
- Wireless Infra-red (IR) communications
- Glass mount kit included
- 2000 users
- 2000 local transaction storage
- 2 onboard Form C relays
- Hub Manager Professional software compatible (7.2 or greater)
- Scalable 99 doors per site
- Card, code, card and/or code capabilities
- Proximity reader can be mounted up to 10 feet from the controller
- Midnight crossing time zones & Holiday scheduling



### SPECIFICATIONS

- No communication wiring needed, resulting in faster and less costly installation.
- Lower total system installation cost.
- Integrated door control, proximity reader and keypad provide a fast complete system installation.
- Hub Manager Professional software is included for expanded system functionality.

## Data Transfer Device

Hand-held DATA TRANSFER DEVICE (model DTD) for wireless infrared (IR) transfer of data and retrieval of stored events from the software managed prox.pad plus IR, LS2 and LS2P Series wireless access control locksets. Data is saved to an internal memory for transfer to a PC via USB connection. Powered by 4 "AA" batteries. Includes Hub Manager Professional software, USB cable & batteries

### FEATURES

- Infrared hand held communication
- Battery powered
- Works with the prox.pad plus IR single door access system
- Works with the LS2 & LS2P access control locksets



## Access Systems Keypads & Readers

Several styles of keypads and readers are available to meet most system requirements. We offer a wide range of keypad and reader styles with the ability to communicate to IEI access systems, or most standard Wiegand protocol systems.

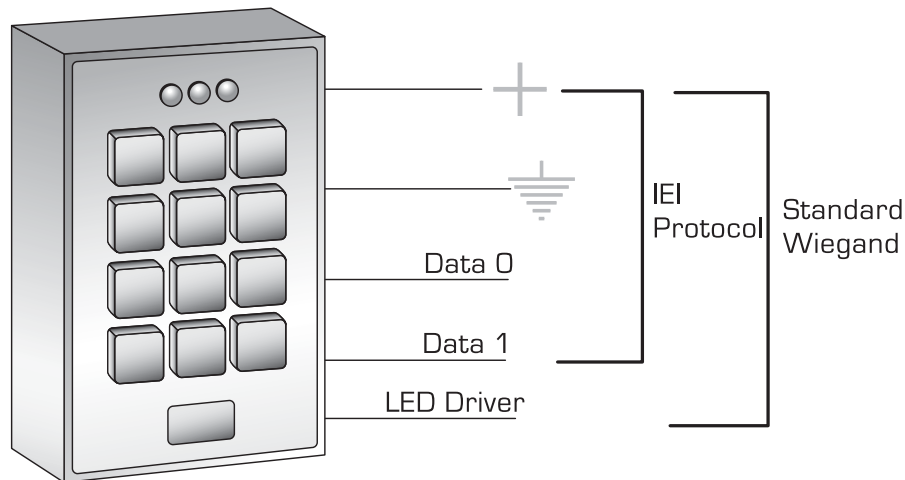

### Secured Series/Wiegand Series (SSW)

SS Wiegand series keypads offer both IEI IM proprietary reader communication protocol, and standard Wiegand communication protocol in multiple style choices.

### Secured Series (SS) – IEI Proprietary Protocol

SS Series keypads and readers are designed as front-end readers for Max 3 access control systems.

### Wiegand (W)

A wide range of readers that are used as front-ends for most systems that accept standard Wiegand data.

# Keypad and Reader Compatibility Table

	Accessibility			Communication Protocol				Compatible with Access Credential Type										
	Keypad	Proximity	Magnetic Card	RS-232	Wiegand	Secured Series	AWID	125 kHz Proximity Card or Fob					13.56 MHz Proximity Card or Fob				Magnetic Card	
								HID	GE/CASI	Leibel	FIPS 201 PIV II	ISOX	ISOX LITE	MIFARE	DESFire	Track II ANSI Card		
XF1100D-PIV		●			●		●	●	●	●	●	●	●	●	●			
XF2100D-PIV		●			●		●	●	●	●	●	●	●	●	●	●		
XF2110D-PIV		●			●		●	●	●	●	●	●	●	●	●	●		
XF1100		●			●		●	●	●	●		●	●	●	●	●		
XF2100D		●			●		●	●	●	●		●	●	●	●	●		
XF2110D	●	●			●		●	●	●	●		●	●	●	●	●		
XF1050		●			●		●	●	●	●								
XF1060MF		●			●								●	●	●			
XF1060XX		●			●							●						
XF1500D		●			●		●	●	●	●		●	●	●	●			
XF1550		●			●		●	●	●	●								
SSW-ILM	●				●	●												
SSW-FX	●				●	●												
SSW-ILW	●				●	●												
SS-PROXPOINT		●			●	●		●										
PROX.PAD	●	●			●	●		●										
PROXPOINT PLUS		●			●			●										
MINIPROX		●			●			●										
THINLINE II		●			●			●										
PROXPRO II		●			●			●										
MAXIPROX		●		●	●			●										
SR2400		●			●		●											
MM6800		●		●	●		●											
SP6820		●		●	●		●											
KP6840	●	●		●	●		●											
MR1824		●		●	●		●											
WP644			●		●													●
SS-KP500WP	●					●												
SS-KP500R-WH	●					●												
CR500W			●		●													●

## Access Systems Keypads & Readers

### Fips 201 PIV Readers



#### XF1100D-PIV

- Multi-frequency mullion reader
- 125 kHz & 13.56 MHz
- FIP 201 US Government Compliance
- PIV II credential compatible
- Read range up to 5" with proximity
- Read range up to 2" for PIV II credentials
- Tri-state LED
- Tamper detection
- 5.85" x 1.72" x 1.14"



#### XF2100D-PIV

- Multi-frequency mid-range reader
- 125 kHz & 13.56 MHz
- FIP 201 US Government Compliance
- PIV II credential compatible
- Read range up to 8" with proximity
- Read range up to 2" for PIV II credentials
- Tri-state LED
- Tamper detection
- 5.85" x 4.5" x 1.45"



#### XF2110D-PIV

- Multi-frequency mid-range reader and keypad
- 125 kHz & 13.56 MHz
- FIP 201 US Government Compliance
- PIV II credential compatible
- Read range up to 8" with proximity
- Read range up to 2" for PIV II credentials
- Tri-state LED
- Tamper detection
- 5.85" x 4.5" x 1.45"

### xCeed ID Smart Card/Weigand Readers



#### XF1100D

- Multi-frequency mullion reader
- 125 kHz & 13.56 MHz
- Read range up to 5"
- Tri-state LED
- Tamper detection
- 5.85" x 1.72" x 1.14"



#### XF2100D

- Multi-frequency mid-range reader
- 125 kHz & 13.56 MHz
- Read range up to 8"
- Tri-state LED
- Tamper detection
- 5.85" x 4.50" x 1.45"



#### XF2110D

- Multi-frequency mid-range reader and keypad
- 125 kHz & 13.56 MHz
- Read range up to 8"
- Tri-state LED
- Tamper detection
- 5.85" x 4.50" x 1.45"



#### XF1050

- Single-frequency mullion reader
- 125 kHz AWID, HID, xCeedID, Casi/ProxLite compatible
- Read range up to 3"
- Tri-state LED
- 4.02" x 1.72" x 1.00"



#### XF1060MF

- Single-frequency mini-mullion reader
- 13.56 MHz MIFARE, DESFire, and ISOX Lite compatible
- Read range up to 3"
- Tri-state LED
- 4.02" x 1.72" x 1.00"



#### XF1060XX

- Single-frequency mini-mullion reader
- 13.56 MHz ISOX compatible
- Read range up to 3"
- Tri-state LED
- 4.02" x 1.72" x 1.00"



#### XF1500D

- Multi-frequency wall-mount reader
- 125 kHz & 13.56 MHz AWID, HID, xCeedID, Casi/ProxLite compatible
- Read range up to 5"
- Tri-state LED
- Tamper detection
- UL 294 Listed
- 5.1" x 3.25" x 1.45"



#### XF1550

- Single-frequency wall-mount reader
- 125 kHz AWID, HID, xCeedID, Casi/ProxLite compatible
- Read range up to 5"
- Tri-state LED
- Tamper detection
- UL 294 Listed
- 5.1" x 3.25" x 1.45"

### Secured Series / Wiegand Readers



#### SSW-ILM-BZ (BRONZE)

#### SSW-ILM-AL (ALUM.)

- Illuminated, hardened keys
- Fits on door frame
- Available in Bronze or Aluminum
- 6.48"x 1.71"x 1.12"



#### SSW-FX

- Vandal-resistant metal case
- No moving parts
- Touch sensitive flat keys
- 5.1"x 3.47"x .71"



#### SSW-ILW

- Illuminated hardened keys
- Flush mount
- 5.1"x 3.47"x .71"



#### SS-PROXPOINT-BK (black)

#### SS-PROXPOINT-GY (gray)

- HID compatible
- Fits on door frame
- Read range 2-3"
- 3.135"x 1.7"x .510"
- Available in gray and black
- UL 294



#### PROX.PAD™

- Keypad & proximity
- HID compatible
- Includes glass mount kit
- 5.26"x 2.75"x 1.375"
- UL 294

## Wiegand Only Readers



- ProxPoint Plus-BK** (black)  
**ProxPoint Plus-GY** (gray)
- Mini mullion-mount proximity reader
  - HID Compatible
  - Read range 2-3"
  - UL 294 Listed
  - 3.135" x 1.7" x .66"



- MiniProx-BK** (black)  
**MiniProx-GY** (gray)
- Mullion-mount proximity reader
  - HID Compatible
  - Read range up to 5.5"
  - Sealed for indoor or outdoor use
  - Tamper detection
  - UL 294 Listed
  - 6.0" x 1.7" x 1.0"



- ThinLine II-BK** (black)  
**ThinLine II-GY** (gray)
- Low profile proximity reader
  - HID Compatible
  - Read range up to 5.5"
  - UL 294 Listed
  - 4.7" x 3.0" x .5"



- ProxPro II-BK** (black)  
**ProxPro II-GY** (gray)
- Medium range proximity reader
  - HID Compatible
  - Read range up to 8"
  - UL 294 Listed
  - 5.0" x 5.0" x 1.0"



- MaxiProx**
- Long range proximity reader
  - HID Compatible
  - Read range up to 24"
  - Tamper detection
  - UL 294 Listed
  - 11.8" x 11.8" x 1.0"



- SR 2400**
- 4 – 5 1/2" read range
  - Metal compensated, Mullion mounting
  - Standard Wiegand output
  - Compatible with AWID credentials
  - UL 294
  - 1.80" x 4.50" x .70"



- MM 6800**
- 6 – 8" read range
  - Metal compensated, Mullion mounting
  - Wiegand & RS232 output
  - Compatible with AWID credentials
  - UL 294
  - 1.75" x 6.00" x 1.00"



- SP 6820**
- 6 – 8" read range
  - Mounts to single-gang electrical box
  - Wiegand & RS232 output
  - Compatible with AWID credentials
  - UL 294
  - 3.10" x 4.60" x .875"



- KP 6840**
- 6 – 8" read range
  - Keypad output
  - Mounts to single-gang electrical box
  - Wiegand & RS232 output
  - Compatible with AWID credentials
  - UL294
  - 3.10" x 4.60" x .875"



- MR 1824**
- 18-24" read range
  - 5 – 12VDC low current draw
  - Wiegand & RS232 output
  - Compatible with AWID credentials
  - UL 294
  - 8.00" x 7.41" x 1.5"



- WP644**
- Dorado weatherproof pass-through reader
  - Accepts magnetic stripe credential
  - Wiegand or Clock-and-Data output
  - 4.75 - 5.25 VDC@ 35mA
  - 6.0" x 1.75" x 1.49"

## Secured Series Only Readers



- SS-KP500WP**
- Vandal-resistant
  - Metal keys w/Braille
  - Surface mount
  - 4.5" x 3.0" x 1.55"



- SS-KP500R-WH**
- One piece housing suitable for wall, post, or gooseneck mounting
  - 5.25" x 3.75" x 2.5"



- CR500W**
- Uses any Track II ANSI cards
  - 4.5" x 1.75" x 1.55"

# Accessories

## Communications Devices



### SEG-M

This Secure Ethernet Gateway converts TCP/IP to serial, which enables IEI access systems to use existing corporate network infrastructures. It plugs easily into the Max3, HubMax II, MiniMax 3 & Hub MiniMax II backplanes.



### SS-IM

- Converts 26-bit Wiegand data to IEI proprietary reader data
- For use with HubMax II & Hub MiniMax II access systems
- 5-12 VDC
- UL 294 Listed



### IEI232-485 Converter

- Converts either RS232 or RS485 at the PC for communication to IEI PC Based Access Control Systems

## Legacy Support Accessories



### SEG-1

This Secure Ethernet Gateway is a wall mounted device enabling TCP/IP to serial conversion. It enables IEI access systems to use existing corporate network infrastructures.



### M3M Max 3 Modem

- Provides dial-up remote site management for Max 3 and MiniMax 3 systems
- Convenient "stackable" mounting to Max 3 module
- Supports a wide variety of PC side modems
- Primary and backup power from system



### USB-Serial

- Converts either RS232 and/or RS485 to USB
- For use with Max 3, HubMax II and prox.pad plus access systems



### SS-Modem

- Plug in modem for HubMax II & Hub MiniMax II access systems
- Remotely program HubMax II & Hub MiniMax II access systems
- 12-24 VDC/VAC

## Access Credentials

### Cards

#### 26-Bit Wiegand 125 kHz HID Cards

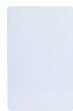

##### EA-EV-C1001

- Premium blank white cards
- 30 mil thickness
- 5 packs of 100 cards



##### EA-EV-C2001

- Premium blank white paper cards
- 10 mil thickness
- 5 packs of 100 cards



##### EA-EV-C4001

- Blank white cards
- 30 mil thickness
- 5 packs of 100 cards

##### ISOProx

- Sold in lots of 25

##### ProxCrd II

- Pre-punched in portrait orientation
- Sold in lots of 25

#### 26-Bit Wiegand 125 kHz HID Prox/Mag Cards



##### EA-EV-C1003

- Premium blank white cards
- 30 mil thickness
- 5 packs of 100 cards



##### EA-EV-C4003

- Blank white cards
- 30 mil thickness
- 5 packs of 100 cards

##### DuoProx

- For Prox.Point readers
- Sold in lots of 25

#### 26-Bit Wiegand 125 kHz AWID Cards



##### CS26S

- Clam shell style prox badges, no logos
- Pre-punched in portrait orientation
- Sold in lots of 25

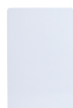

##### GR26S

- Graphics quality both sides
- ISO compliant
- Sold in lots of 50

#### 36-Bit Wiegand 125 kHz AWID Cards



##### CS36S

- Clam shell style prox badges, no logos
- Pre-punched in portrait orientation
- Sold in lots of 25



##### CS36S-L

- Clam shell style prox badges with logos
- Pre-punched in portrait orientation
- Sold in lots of 25

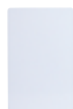

##### GR36S

- Graphics quality both sides
- ISO compliant
- Sold in lots of 50

#### 26-Bit Wiegand 125 kHz AWID Prox/Mag Cards



##### GRMAG26S

- 3-track high-CO ABA magnetic stripe
- Graphics quality ISO with cards
- Sold in lots of 50

#### 36-Bit Wiegand 125 kHz AWID Prox/Mag Cards



##### GRMAG36S

- 3-track high-CO ABA magnetic stripe
- Graphics quality ISO with cards
- Sold in lots of 50

#### 13.56 MHz xCeedID Smart Cards



##### 9432

- Proximity Clam Shells
- 2.5k bit memory
- Sold in lots of 50

##### 9440

- Proximity Clam Shells
- 10k bit memory
- Sold in lots of 50

##### 9532

- Proximity Cards
- 2.5k bit memory
- ISO graphic quality type cards
- Sold in lots of 50

##### 9540

- Proximity Cards
- 10k bit memory
- ISO graphic quality type cards
- Sold in lots of 50

#### Magnetic Stripe Cards



##### MagCrd-25

- Track II encoded
- Low-CO magnetic stripe
- Sold in lots of 25

##### MagCrd-100

- Track II encoded
- Low-CO magnetic stripe
- Sold in lots of 100

##### MagHico-25

- Track II encoded
- High-CO magnetic stripe
- Sold in lots of 25

##### MagHico-100

- Track II encoded
- High-CO magnetic stripe
- Sold in lots of 100

#### 125 kHz Indala Proximity Cards

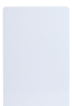

##### PrxCrd-25

- Indala reader compatible
- Sold in lots of 25

##### PrxCrd-100

- Indala reader compatible
- Sold in lots of 100

### Key Fobs



##### 9640

- xCeedID Smart Card Tags
- 13.56 MHz Proximity Key Tags
- 10k bit memory
- Sold in lots of 50



##### KT26S

- Wiegand 125 kHz Proximity Key Fobs
- Standard 26-bit format
- AWID compatible
- Sold in lots of 20



##### KT36S

- Wiegand 125 kHz Proximity Key Fobs
- IEI 36-bit format
- AWID compatible
- Sold in lots of 20

##### ProxKey

- Wiegand 125 kHz Proximity Key Fobs
- Standard 26-bit format
- HID compatible
- Sold in lots of 25



##### TchChp-25

- Touch Reader Chips
- Track II encoded
- Dallas Semi-conductor touch chip
- Works with SS-TCH500W reader
- Sold in lots of 25



##### TchChp-100

- Touch Reader Chips
- Track II encoded
- Dallas Semi-conductor touch chip
- Works with SS-TCH500W reader
- Sold in lots of 100

### Tokens



##### MicroProx

- Wiegand 125 kHz Proximity Tags
- Standard 26-bit format
- HID compatible
- 1-inch diameter with adhesive back
- Sold in lots of 20



##### PW26S

- Wiegand 125 kHz Proximity Wafers
- Standard 26-bit format
- AWID compatible
- 1-inch diameter with adhesive backing
- Sold in lots of 50

##### PW36S

- Wiegand 125 kHz Proximity Wafers
- IEI 36-bit format
- AWID compatible
- 1-inch diameter with adhesive backing
- Sold in lots of 50



# STAND ALONE ACCESS CONTROL

With a broad selection of Access Control Devices and accessories, we have a solution for your specific environment. Our electronic keypads are being used today at thousands of companies throughout the world for stand alone operations.

Regardless of the application or your requirements, we have the style and functionality to meet most needs, either indoor, outdoor, extreme weather environments, illuminated, vandal resistant, Wiegand output, or many other performance considerations.

We make product selection easy, whether you are choosing for functionality or style, or both. We provide the added benefit of simple and consistent programming across all our products. You decide the keypad that is best for your requirements.

The quality of the products, combined with our advanced engineering and design capabilities, results in our stand alone access control devices being second to none.

Quick Selection Guide	26
Functionality	28
Keypads	30
Card Readers	34
Accessories	36
Industrial Machinery Control	37

# Door•Gard™

## Quick selection guide

To begin the process of selecting the appropriate product for your application, we have organized this section to walk you through the selection process. The following charts outline the performance and functionality available with different keypad styles. This section also contains detailed product views with specific information and images for each style of keypad and reader. This section ends with functionality group descriptions and available accessories.

## Select your style according to your needs



## Choose the functionality

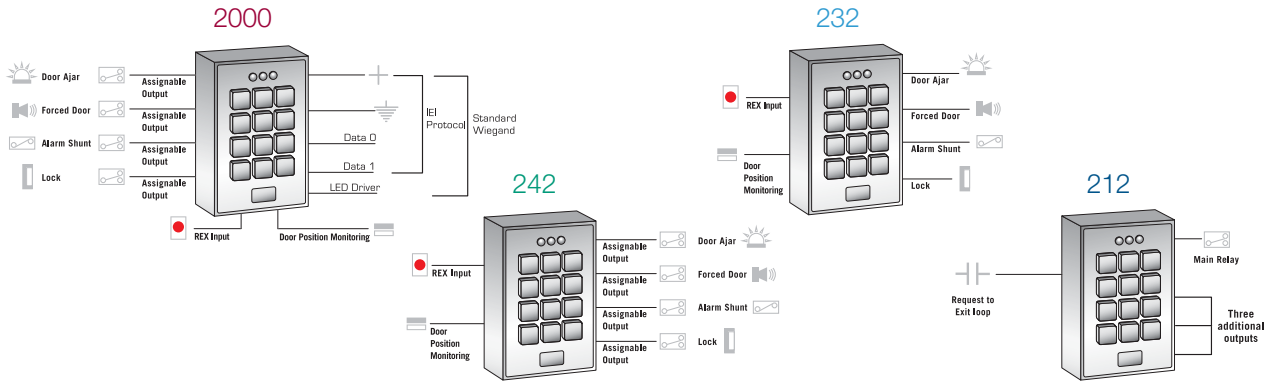

## Options

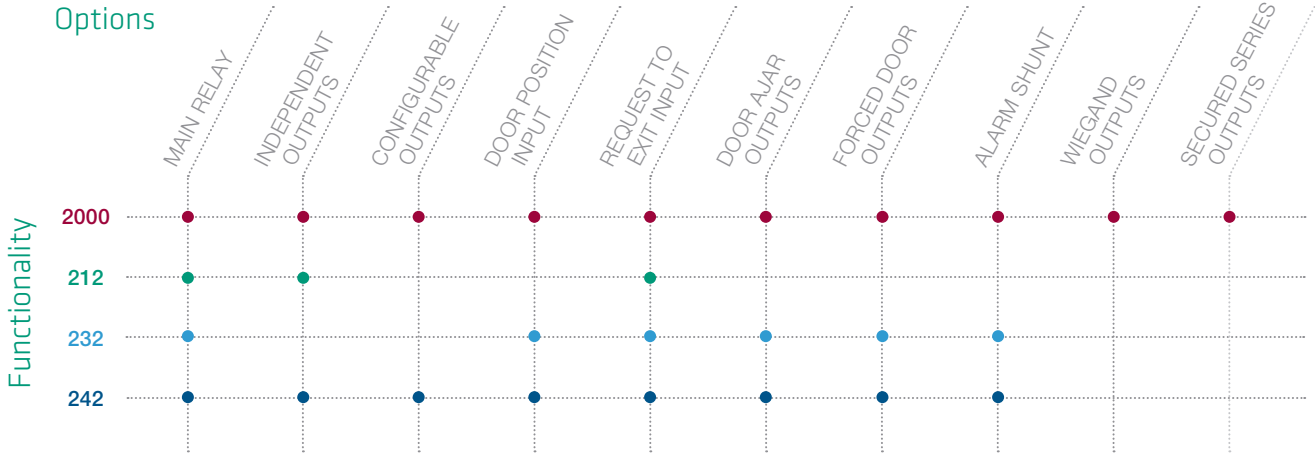

## Combine functionality with style

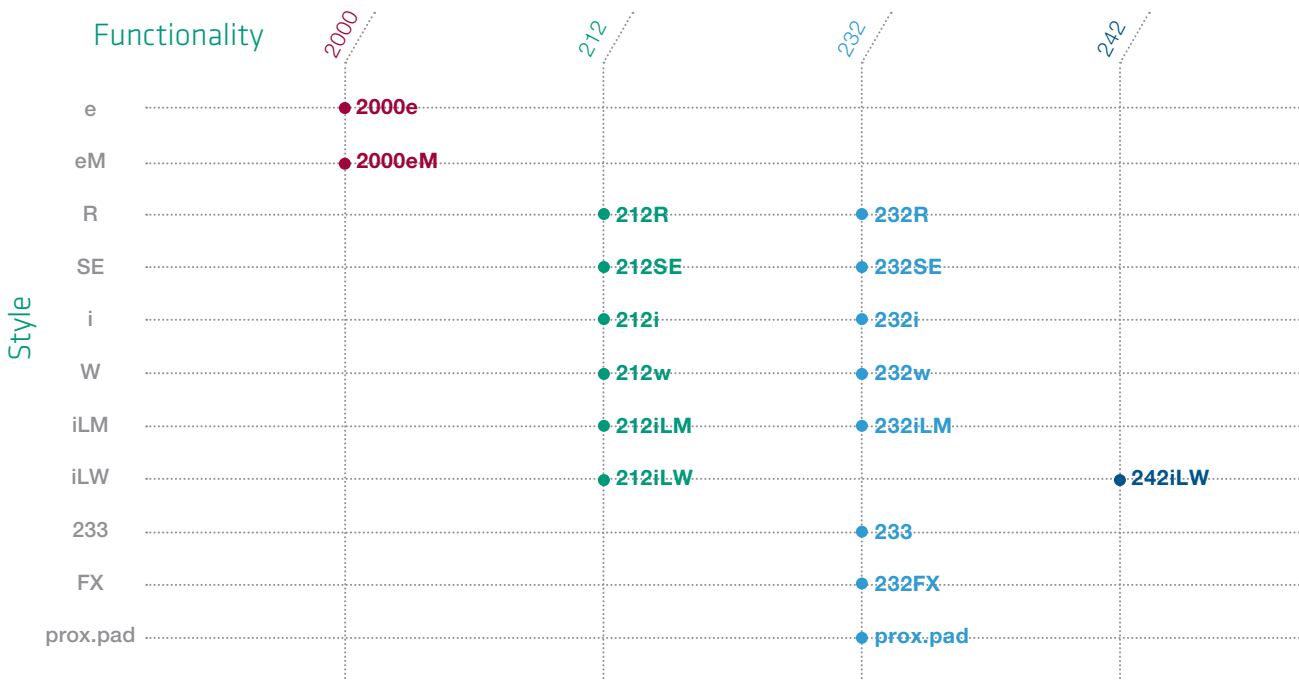

## 2000 Series

The 2000 Series is our newest offering that combines all of our functionality groups into one powerful platform. The 2000 Series access control keypads manage up to 500 users and provide complete access control functionality including monitoring door position; controlling locking hardware; triggering a propped or forced door alert or alarm shunt output. The 2000 Series outputs can be expanded using the expansion relay module [Model 2000-8EX] that provides 8 additional Form C outputs for a system total of 10 Form C outputs. Some applications for the 2000 Series keypads include; operating as keypad front ends for access system, controlling many other electronic devices such as handicapped doors, gate controls, alarm systems, ATM vestibules, and other types of machinery requiring momentary or latched outputs. You can select between two modes of functionality with the 2000 Series keypads. They can operate as keypad front ends to IEI access systems and most Wiegand access system controllers, or as stand alone access control devices.

### FEATURES

- 500 users
- Uniform IEI programming & wiring
- Door position input
- Request to Exit input
- 2 Form C SPDT relay outputs – default for access control function
- Expansion relay module (2000-8EX) – 8 additional outputs for elevator and other applications
- Sounder for key press and alert conditions
- All outputs can be programmed independently if required
- Option for secure installation with control electronics in protected area
- Widest array of user type options including single use and two man rule
- 10-30 VDC and 12-24 VAC operation
- Over-voltage protection for reliable operation
- Programmable Wiegand formats
- Works as a reader for all IEI and Wiegand access systems

STYLES: e, eM

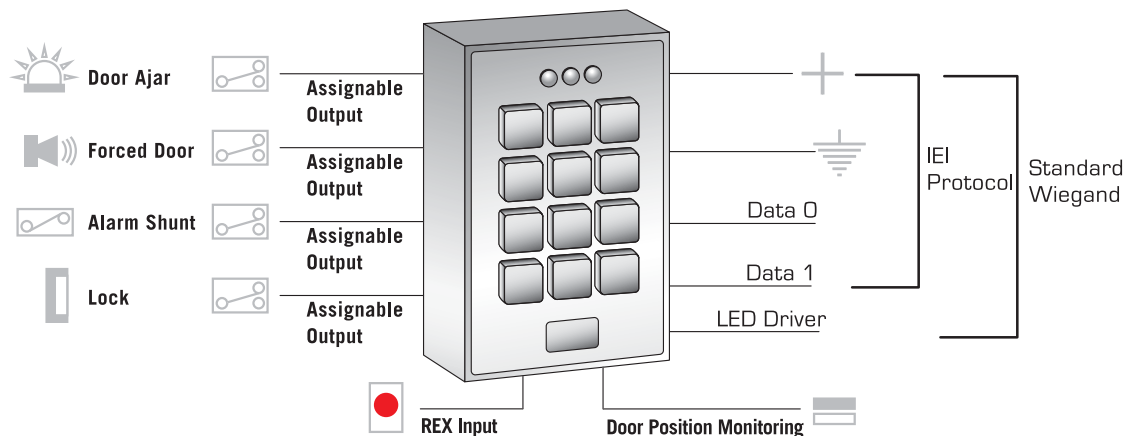

## 212 Series

The 212 Series keypads are designed for basic access or code control for up to four individual devices (model dependent), and one input from a request to exit loop. These keypads are the perfect choice for controlling electric locks or magnetic locks, security systems, elevator control, gate controls or other types of equipment requiring on/off or momentary control inputs.

### FEATURES

- 120 Users
- Input Trigger for Request to Exit or other open circuit contact
- Up to 4 independent relay outputs
- Each output is assignable by code
- Keypad programmable

STYLES: R, SE, i, W, iLM, iLW

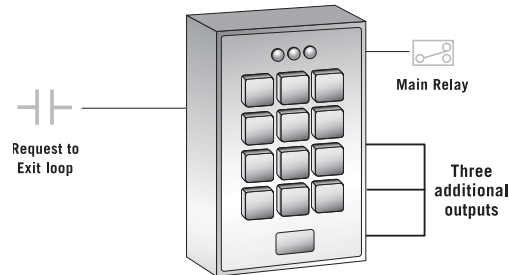

## 232 Series

The 232 keypads are designed to meet most residential, commercial, and industrial single door access control requirements. Each 232 keypad provides two inputs and four outputs, factory set access control. Utilizing the door position input will trigger features such as: Auto relock, Door forced and Door ajar.

### FEATURES

- 120 Users
- Request to Exit input loop
- Door position monitor input loop
- Relay Outputs: Lock Release, Door Forced, Door Propped, Alarm Shunt
- Keypad programmable

STYLES: R, SE, W, i, iLM, 233, FX, prox.pad

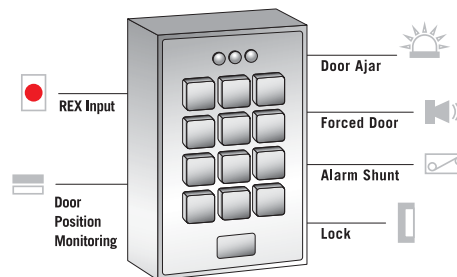

## 242 Series

The 242 Series combines the ease of the 232 Series with the flexibility of the 212 Series. It's four pre-programmed access control outputs can be reconfigured to operate in any combination by a valid PIN entry. This functionality allows the keypad to monitor the door position like the 232 Series and trigger the Door Forced output, while operating multiple separate outputs after valid PIN entry.

### FEATURES

- Four Independently configurable relay outputs
- All relay outputs assignable by code
- Request to Exit input Loop
- Door position monitor input loop
- 120 Users
- Relay outputs programmable for latched or timed operation
- Door position monitor input loop
- Access control functionality: Door forced, Door ajar, Alarm shunt

STYLES: iLW

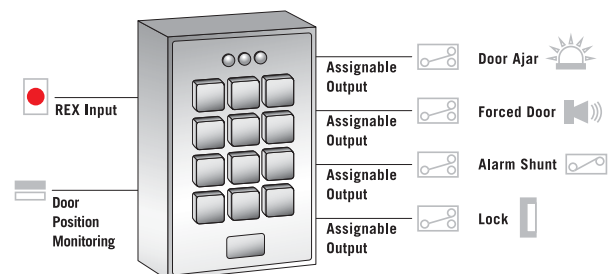

## e Style - Flush Mount Backlit

The e style keypad uses hardened backlit keys to ensure long-term durability and high-quality performance. e style keypads are designed for both indoor and outdoor flush mount applications. The electronics for each e keypad are conformal coated in the manufacturing process in order to provide this level of application flexibility.

### FEATURES

- Single-gang flush mount design
- Backlit hardened keys
- Polycarbonate trim
- Key press feedback via sounder and yellow LED
- Built-in assignable sounder
- Bi-color Red/Green LED indicates relay status
- Indoor/outdoor use
- Keypad Programmable
- Five year warranty
- Functionality mode: 2000 Series

### SPECIFICATIONS

- Operating Voltage: 10-30 VDC; 12-24 VAC auto-adjusting
- Dimensions: 4.50" x 2.75" x 0.60"
- Temperature tolerance: -20F to 130F



2000e



## i Style - Flush Mount Indoor

Affordable single door access control keypad designed to meet the indoor flush mount needs of lighter volume access control environments. There are three LED's to indicate operation status and provide the user with visual PIN entry confirmation. The i style keypad mounts to most standard single-gang electrical back boxes.

### FEATURES

- Single-gang design
- 212i - 1 SPDT 2 amp relay and three 50mA negative voltage outputs
- With 212 mode; Optional 293 relay board converts 3 voltage outputs to SPDT relays
- 232i - 1 SPDT 2 amp relay and three 1 amp SPDT relays
- Door Position Monitoring – 232 mode only
- Door ajar, Forced door, Alarm shunt outputs – 232 mode only
- Indoor use only
- Functionality mode: 212, 232

### SPECIFICATIONS

- Operating voltage: 12-24 VAC/VDC - auto adjusting
- Dimensions: 2.75" x 4.50" x 1.13"
- Dimensions including the 293 relay module: 2.75" x 4.5" x 1.68"
- Current draw: 94 mA maximum (add 30 mA for each relay)
- Temperature tolerance: -20F to 130F



212i / 232i

## eM Style - Flush Mount Durable Metal

The eM style keypad uses metal Braille alpha-numeric keys to ensure long-term durability and high-quality performance. eM style keypads are designed for both indoor and outdoor flush mount applications. The electronics for each eM keypad are conformal coated in the manufacturing process in order to provide this level of application flexibility.

### FEATURES

- Single-gang flush mount design
- Metal Braille alpha-numeric keys
- Brushed metal trim
- Conformal coating
- Key press feedback via sounder and yellow LED
- Built-in assignable sounder
- Bi-color Red/Green LED indicates relay status
- Indoor/outdoor use
- Keypad programmable
- Five year warranty
- Functionality mode: 2000 Series

### SPECIFICATIONS

- Operating Voltage: 10-30 VDC; 12-24 VAC auto-adjusting
- Dimensions: 4.50" x 2.75" x 0.60"
- Temperature tolerance: -20F to 130F



2000eM



## w Style - Flush Mount Weather Resistant

The w style single door access control keypad is designed to meet the indoor/outdoor flush mount needs of lighter volume access control environments. The w style features a sealed membrane keypad that allows the keys to be cleaned and resist moisture. There are three LED's to indicate operation status and provide the user with visual PIN entry boxes. The w style keypad mounts to most standard single-gang electrical back boxes.

### FEATURES

- Single-gang design
- 212w - 1 SPDT 2 amp relay and three 50mA negative voltage outputs
- With 212 mode; Optional 293 relay board converts 3 voltage outputs to SPDT relays
- 232w - 1 SPDT 2 amp relay and three 1 amp SPDT relays
- Door Position Monitoring – 232 mode only
- Door ajar, Forced door, Alarm shunt outputs – 232 mode only
- Indoor/outdoor use
- Functionality mode: 212, 232

### SPECIFICATIONS

- Dimensions: 2.75" x 4.50" x 1.13"
- Dimensions including the 293 relay module: 2.75" x 4.5" x 1.675"
- Operating voltage: 12-24 VAC/DC - auto adjusting
- Current draw: 94 mA maximum (add 30 mA for each additional relay)
- Temperature tolerance: -20F to 130F



212w / 232w

## iLW Style - Architectural Weather Resistant Backlit

The iLW keypad has a chrome plated metal trim with hardened backlit keys. There are LED's shown through the face plate to indicate operation status and provide the user confirmation of PIN number entry. Designed for indoor or outdoor use, the iLW keypad mounts to any standard single-gang electrical back box and provides superior durability.

### FEATURES

- Single-gang flush mount design
- Hardened backlit keys
- Heavy chrome plated trim ring
- Key press feedback via sounder and yellow LED
- Built-in assignable sounder
- Bi-color Red/Green LED indicates relay status
- Indoor/outdoor use
- Keypad Programmable
- Functionality mode: 212, 242

### SPECIFICATIONS

- Operating Voltage: 10-30 VDC; 12-24 VAC auto-adjusting
- Dimensions: 3.47" x 5.14" x 0.71"
- Temperature tolerance: -20F to 130F



212iLW / 242iLW / SSW-iLW

## FX Style - Harsh Environmental

Combining elegant looks and the durability of a solid-state keypad in a weather proof design, the FX style keypad can be utilized for most any application. Designed for outstanding performance in high traffic and harsh environments, the solid-state touch sensitive keypad will continue to operate in the worst of conditions. The electronics have been conformal coated in the manufacturing process accompanied with the keypad design, provide an unsurpassed level of application flexibility. There are two LED's to indicate operation status and provide the user with visual PIN entry confirmation.

### FEATURES

- Heavy chrome plated trim ring
- Flush mount
- Fits single-gang electrical box
- Touch sensitive solid-state flat keys
- Bi-color LED to indicate operation
- Indoor/outdoor
- Internal sounder
- Functionality mode: 232

### SPECIFICATIONS

- Dimensions: 3.44" x 5.16" x 0.71"
- Operating voltage: 12-24 VDC
- Temperature tolerance: -20F to 130F



232FX / SSW-FX

## iLM Style - Mullion Mount Backlit

Elegantly designed backlit keypad suitable for indoor and outdoor installations. The iLM keypad mounts directly to mullion door frames or most flat surfaces with no backbox required. The convenience of the built-in doorbell feature with the iLM's sleek design make it an easy choice for entrance installations. Each of the iLM keypads have their electronics conformal coated during the manufacturing process to provide increased application flexibility.

### FEATURES

- Surface mount - fits on door mullion
- 1 - 2 amp SPDT relay (212 model)
- 3 - 1 amp SPDT relays in controller (232 model)
- Door Position Monitoring (232 model)
- Door ajar, Forced door, Alarm shunt outputs (232 model)
- Backlit hardened keys
- Sounder
- Available in Aluminum-AL or Bronze-BZ
- Door bell relay
- Indoor/outdoor use
- Functionality mode: 212, 232

### SPECIFICATIONS

- Operating Voltage: 12/24 volts AC/DC - Auto-adjusting
- Dimensions: 1.71" x 6.48" x 1.13"
- Temperature tolerance: -20F to 130F



212iLM / 232iLM / SSW-iLM

## R Style - Ruggedized

The ruggedized r style keypad features a cast aluminum housing and all metal faceplate that has been treated with polyurethane to increase its protection from corrosion. The ruggedized uses an all metal Braille, alpha-numeric keys. There is also an internal sounder that is used to indicate key press feedback. The Ruggedized's housing can be mounted to a variety of surfaces. Suggested mounting includes; gate goosenecks, post, concrete walls, etc. Additional tamper resistance is provided with the onboard tamper loop that can be used to indicate the removal of the faceplate.

### FEATURES

- Indoor/outdoor weather resistant, self contained metal housing
- Surface mount vandal resistant design
- One piece housing suitable for wall, post, or gooseneck mounting
- Durable metal Braille alpha-numeric keys
- 212 mode - 4 on board programmable timed relays
- 232 mode - 1 SPDT 2 amp relay and 3 - 1 amp SPDT access relays
- Door Position Monitoring – 232 mode
- Door ajar, Forced door, Alarm shunt outputs – 232 mode
- Functionality mode: 212, 232

### SPECIFICATIONS

- Current draw: 108 mA maximum (add 30 mA for each additional relay)
- Operating voltage: 12-24 VAC/DC - auto adjusting
- Dimensions: 3.75" x 5.25 x 2.50"
- Temperature tolerance: -20F to 130F



212R / 232R

## SE Style - Sealed Environmental

The sealed environment se style keypad features a brushed metal housing that has been treated to resist corrosion and an all metal Braille, alpha-numeric keypad. There is an internal sounder that is used to indicate key press feedback, and a bi-color LED to indicate operation. The housing has been designed to mount directly on a standard single-gang electrical box, or to most flat surfaces.

### FEATURES

- Indoor/outdoor self contained brushed metal housing
- Surface mount vandal resistant design
- One piece housing suitable for wall, post, or gooseneck mounting
- Durable metal Braille alpha-numeric keys
- 212 mode - 4 on board programmable timed relays
- 232 mode - 1 SPDT 2 amp relay and 3 - 1 amp SPDT access relays
- Door Position Monitoring – 232 mode
- Door ajar, Forced door, Alarm shunt outputs – 232 mode
- Tamper loop functionality mode: 212, 232

### SPECIFICATIONS

- Current draw: 108 mA maximum (add 30 mA for each additional relay)
- Operation voltage: 12-24 VAC/VDC - auto adjusting
- Dimensions: 3.00" x 4.50" x 1.55"
- Temperature tolerance: -20F to 130F



212SE / 232SE

## Magnetic Card Reader

The Model 233 magnetic card reader reads ANSI Track II encoded magnetic cards. This type of encoding can be found on most credit cards, bank ATM cards, state ID's, drivers license and access control system cards. A built in test feature will allow testing of a card to confirm its system compatibility prior to attempting to program the card(s). The sleek narrow design allows the card reader to be mounted to a mullion door frame or any flat surface. The need for a back box is not required, increasing the application flexibility. A unique feature of the 233 is the ability to set the system into an ATM mode that allows access to cards that have track II information, without having to program the cards into the system. The magnetic card readers brushed metal finish and elegant design, make it a perfect choice for commercial or residential installations.

### FEATURES

- Surface mount - fits on door mullion
- Two-piece unit, includes remote controller w/programming keypad
- 1 – 5 amp SPDT relay in controller
- 3 - 1 amp SPDT relays in controller
- Door Position Monitoring
- Door ajar, Forced door, Alarm shunt outputs
- Bi-color LED to indicate operation
- Indoor/outdoor capability with up to 120 users
- Functionality mode – 233

### SPECIFICATIONS

- Operating Voltage: 12/24 volts AC/DC – Jumper selectable
- Current draw: 70 mA maximum (add 15 mA for each addition output)
- Dimensions: 1.75" x 4.50" x 1.155"
- Temperature tolerance: -20F to 130F



233

## prox.pad - Integrated Proximity & Controller

IEI's prox.pad is a stand alone proximity reader and keypad that can be directly mounted to a single-gang electrical box or to most flat surfaces. The prox.pad provides standard access control functionality with the use of its two relays and two inputs for request to exit and door position. By utilizing the proximity reader and keypad together, a higher level of security is achieved by requiring both to grant access. The prox.pad can be used for stand alone access control, or used as a reader for IEI access systems or most Wiegand systems. The proximity reader is capable of being mounted up to a maximum of 10 feet away from the prox.pad.

### FEATURES

- Integrated door control, proximity reader and keypad
- 2000 users
- 2000 event audit trail
- Bi-color LED to indicate operation
- HID 26 – 37 bit format card compatibility
- Fits over a single-gang electrical box
- Corporate 1000 compatible
- Glass-mount option included
- Secured Series & Wiegand compatible
- UL 294 Listed

### SPECIFICATIONS

- Dimensions: 2.75" x 5.25" x 1.38"
- Operating voltage: 12 VDC only
- Temperature tolerance: -20F to 130F
- Main relay: Form C 4 amp SPDT
- Auxiliary Relay: Form C 1 amp SPDT



*Remotely Mounted prox.pad proximity reader*

# Accessories

---

## 2000-8EX



The 2000-8EX Output Expansion Module is for use with 2000 Series keypads and provides eight 1 amp Form C relay outputs. It wires to the keypad with 6-wire connection and is powered from the keypad. The module mounts to a double-gang electrical plate and can be installed up to 100' from the keypad.

---

## 293



The 293 Relay Module provides three 1 amp Form C relays and the REX input via screw terminals for the 212i & 212w keypads. These keypads come from the factory with a harness that supplies a 50 mA source, but if relay outputs are required, the 293 is the perfect choice.

---

## 284



The 284 Leaded Accessory Relay is a 5 amp Form C relay with wire leads pre-attached. The relay operates on 12 VDC and provides an easy way to increase the current handling capability of a lower current output.

## PowerKey AC 110 & 220

The UL Listed PowerKey AC Machinery Access Control System is designed to limit the access to powered devices to authorized users only. Power is supplied to the controlled device after a valid code has been entered. After the device has been switched off, PowerKey AC will sense the load reduction and begin a time out before restricting access. Once this time has expired, a valid code must be entered in order to supply power to the device again. PowerKey AC also monitors the circuit for an overload. If an overload has been detected, PowerKey AC will automatically shut down and the LED's will begin flashing alternately to indicate the condition.

### FEATURES

- Lockout unauthorized/untrained users
- 99 Users
- 110 or 220 Volts AC
- UL Listed

### SPECIFICATIONS

- Control up to 1 1/2 HP motor (110 Volt Model)
- Control up to 3 HP motor (220 Volt Model)
- Switch 1 – Load Sensed 50 mA and up
- Switch 2 - Load Unsensed
- Ratings: 110 Volt Model – 20 Amps maximum  
220 Volt Model – 17 Amps maximum

PKAC-110 – 110 Volt Model

PKAC-220 – 220 Volt Model



# ELECTRONIC ACCESS CONTROL LOCKSETS

With thousands of units in operation worldwide, IEI locksets are recognized for the highest level of quality and reliability. Combining field proven keypad technology with a Grade 1 lockset that features metal alphanumeric Braille keys, UV conformal coated electronics and a neoprene gasket, the LS Series UL listed Locksets are rugged and provide true indoor/outdoor durability. LS Series Electronic Access Control Locksets provide the value and accountability of access control where traditional locks and keys were used in the past.

The LS Series locksets are available in a variety of lock configurations to accommodate customer applications. Special order finishes are available to meet most architectural requirements. The LS Series are simple to install with only one additional 1 inch hole (model dependent) where existing locks were installed. For added protection the LS Series provide a through-door wire raceway preventing wire chaffing and additional protection from moisture related failures.

There are three different functional variations of LS series locksets to choose from. The LS1 stores up to 120 users and is programmable from the keypad. The LS2 & LS2P models use the Hub Manager Professional Software program to manage people and doors through step-by-step wizard assisted configuration and easy to use management reports and have full functionality of traditional access system.

Locksets	40
Lock Types	42
Finishes & Options	44
Dimensions	44
Order Guide	45

# Locksets See Order Guide 1 - page 45

## LS1

Providing the combination of access control protection, and an ANSI Grade-1 lockset, the LS1 series locksets are a perfect choice to manage door access that may otherwise not be available through traditional hardwired access systems. The access decisions are made at the door and access is granted to those that have a valid PIN programmed into the LS1.

### FEATURES

- Non-volatile eeprom memory allows in-shop programming
- One non-handed unit for both indoor and outdoor applications
- Wire raceway provides clean installation and protects wires inside door
- Programs the same as all IEI products
- Durable alphanumeric Braille keys
- Selective Lockout of grouped of users
- Passage/Toggle codes allow door to remain unlocked
- Service codes allow one-time entry then are deleted automatically
- Error Lockout for successive invalid attempts
- Two-stage Low Battery Alert assures entry
- Propped Door and Forced Door alerts when used with a normally open magnetic switch
- Request to Exit allows door to be unlocked from a distance

### Compliance

ANSI 156.2, Series 4000 Grade 1

Federal Handicap and ANSI A117.1 Accessibility Code

Federal FF-H-106C

California: (Formerly Title 19, State Fire Marshall)

### Environmental

Electronics sealed in conformal coating process

Through door wire raceway reduces wire exposure to moisture

Neoprene gasket seals exterior housing

-20F to 120F, up to 98% humidity (non-condensing)

### Electrical

Power: 4 AA alkaline batteries

Cycles: Up to 150,000



## LS2 & LS2P

The full featured LS2 & LS2P series locksets provide large system features from an at the door solution. The LS2 & LS2P series locksets are a perfect choice to manage door access that may otherwise not be available through traditional hardwired access systems. The LS2 & LS2P series locksets use an ANSI Grade-1 lockset and the powerful management capabilities of the Hub Manager Professional software.

### FEATURES

- 2,000 individual users per lockset
- 2,000 transactions stored per lockset
- Wireless lockset programming and audit trail retrieval with PDA running Palm OS version 3.5 or newer
- Managed with Hub Manager Professional Software version 4 or higher
- Unlimited Access Levels including Time Zones and Holidays
- 20,000 users per system
- Unlimited Sites
- Import user names

### LS2P:

- Reads HID proximity cards and fobs up to 37-bit
- Users can be Code, Card, Code and Card, Code or Card

### Compliance

ANSI 156.2, Series 4000 Grade 1  
 Federal Handicap and ANSI A117.1 Accessibility Code  
 Federal FF-H-106C  
 California: (Formerly Title 19, State Fire Marshall)

### Environmental

Electronics sealed in conformal coating process  
 Through door wire raceway reduces wire exposure to moisture  
 Neoprene gasket seals exterior housing  
 -20F to 120F, up to 98% humidity (non-condensing)

### Electrical

Power: 4 AA alkaline batteries  
 Cycles: Up to 90,000



### Data Transfer Device (DTD)

Each lockset can be wirelessly programmed through infrared (IR) signals with the Model DTD Data Transfer Device or via select IR equipped PDAs. User codes, access privileges, lockset programming, and transaction history can be transferred between the lockset and a PC running Hub Manager Professional software, which also provides in-depth management reports of people and door activity.

# Lock Type See Order Guide 2 - page 45

## Cylindrical

This lockset easily retrofits into an ANSI 151.8 prepared door and requires only one additional 1" hole for installation.

### FEATURES

- Lock Body: Grade 1 Cylindrical Lockset w/ clutch mechanism
- Latch: Grade 2, 3 hour fire rating reversible with 1/2" throw, 2<sup>3</sup>/<sub>4</sub>" backset
- Strike Plate - 2 <sup>3</sup>/<sub>4</sub>" "T" strike
- Door Thickness: 1 <sup>5</sup>/<sub>8</sub>" to 1 <sup>7</sup>/<sub>8</sub>". 1 <sup>3</sup>/<sub>8</sub>" with optional spacer kit
- Cylinder: Solid Brass Schlage "C" keyway, 6 pin, with (2) nickel silver keys
- Optional Cylinders: I/C Core Prep Lever to accept OEM cylinders (see configuration guide for details)



## Mortise

This lockset retrofits most ANSI 115.1 Mortise prepared doors with the additional of (2) through holes. The LS Series Mortise lockset can be easily installed in a door with an existing mortise lock.

### FEATURES

- Lock Body: Grade 1 Mortise Lock body
- Latch: Stainless Steel Latchbolt with 3/4" projection 1/2" Throw Deadlocking latch
- Door Thickness - 1 <sup>3</sup>/<sub>4</sub>" to 2 <sup>1</sup>/<sub>4</sub>"  
Handing: Field reversible on Crescent and American handles.
- Cylinder: Solid Brass 1 <sup>1</sup>/<sub>8</sub>" Schlage "C" keyway, 6 pin mortise cylinder, with (2) nickel silver keys. 1 <sup>1</sup>/<sub>8</sub>" and 2" can be used with optional spacers
- Optional Cylinders: see configuration guide for details



## Exit

Allows the LS Series locksets to be installed in door applications requiring emergency egress exit bar. Easily installs requiring only (2) additional through holes. Exit bar supplied by others.

### FEATURES

- Door Thickness: 1 3/4" to 2 1/4"
- Cylinder: Solid Brass 1 1/8" Schlage "C" keyway, 6 pin mortise cylinder, with (2) nickel silver keys. 1 1/8" and 2" can be used with optional spacers
- Optional Cylinders: see configuration guide for details
- **Requires Exit Device Mounting Kit: see configuration guide for details**
- Also compatible with Rim panic devices, surface horizontal rod devices. Contact factory for installation instructions for these applications



## Deadbolt

This lockset retrofits most ANSI 115.1 Mortise with Deadbolt prepared doors with the additional of (2) through holes. The LS Series Deadbolt lockset can be easily installed in a door with an existing mortise and deadbolt lock.

### FEATURES

- Lock Body: Grade 1 Mortise Lock body with Deadbolt
- Latch: Stainless Steel Deadbolt with 1" projection, latchbolt with 1" projection and deadlocking latch. Deadbolt may be projected from option 1 3/4" mortise cylinder with cover cam or thumb turn from inside door
- Door Thickness: 1 3/4" to 2 1/4"
- Privacy Setting feature available
- Cylinder: Solid Brass 1 1/8" Schlage "C" keyway, 6 pin mortise cylinder, with (2) nickel silver keys. To project deadbolt from outside door requires a 1 3/4" mortise cylinder. 1 1/8" and 2" can be used with optional spacers and a straight cam
- Optional Cylinders: see configuration guide for details



## LS Series Options

See Order Guide 3 - page 45

### Finishes:



3 - Polished Brass / US3



10 - Dark Bronze / US10B / 613



26D - Brushed Chrome / US26D

See Order Guide 4 - page 45

### Lever Choices:

#### Crescent

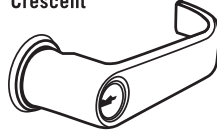

#### American

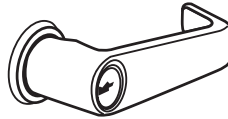

See Order Guide 5 - page 45

### Cylinder Types:

The standard cylinder is a solid brass Schlage "C" keyway installed in the lockset body or handle.

For field installation of commonly available OEM lock cylinders, Cylindrical locksets can be ordered with an I/C core prep lever (no cylinder in the lockset lever). Mortise, Exit, and Deadbolt locksets can be ordered with no cylinder in the lockset body.

See Cylinder Type options in Step 5 of the Order Guide.



Standard Schlage "C" Keyways



## LS Series Dimensions

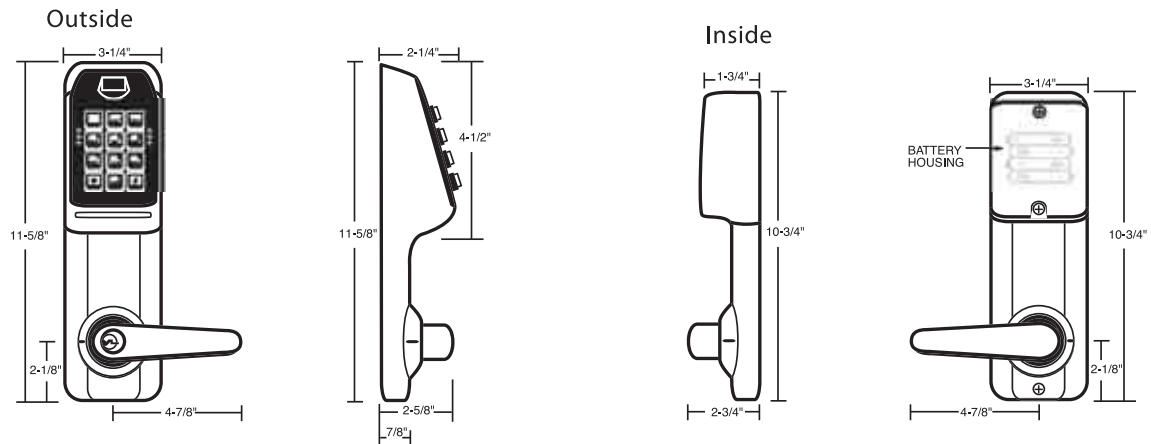

## Data Transfer Device

Hand-held Model DTD DATA TRANSFER DEVICE for wireless infrared (IR) transfer of data and retrieval of stored events from the software managed prox.pad plus IR and LS2P Series wireless access control locksets. Data is saved to an internal memory for transfer to a PC via USB connection. Powered by 4 "AA" batteries. Includes Hub Manager Professional software, USB cable & batteries.

### FEATURES

- Infrared hand held communication
- Battery powered
- Works with the LS2 & LS2P access control locksets



## Order Guide

The model number determines the lockset options.  
Order using these easy steps

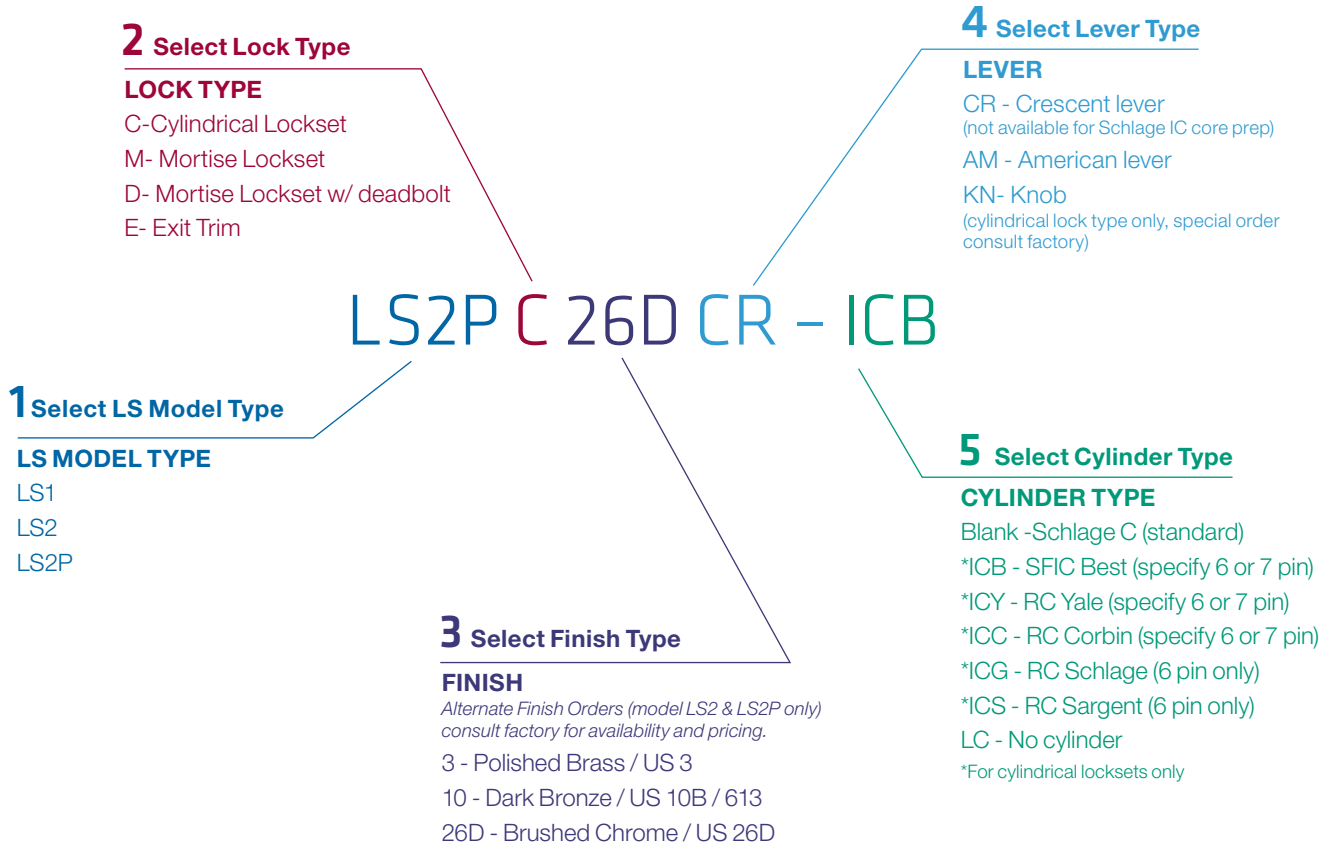

ELECTRONIC ACCESS  
CONTROL LOCKSETS

### SPECIAL HARDWARE ORDERS

*Minimum order quantities may be required, consult factory for availability and pricing*

- B2 - 2-3/8" Backset Latch
- B3 - 3-3/4" Backset Latch Extender
- B5 - 5" Backset Latch Extender
- S2 - 2-3/4" T Strike
- REX - Request To Exit Option In Handle
- SO - Solid Exterior Lever

### EXIT TRIM ADAPTER PLATES

LSEVD	Von Durpin 99	0270001
LSEP	Precision 1100	0270002
LSEYC	Yale 7100 & Corbin ED5200	0270003
LSED	Dorma 9300	0270004
LSESA	Sargent 8800 & Arrow 3800	0270005

# Accessories

## Power Supplies & Surge Protected Transformers



### PG-1224-3

12 or 24 volt DC 2.5 amp supply – board only  
 For your convenience the PG-1224-3 installs onto stand offs in the Max 3 and eMerge cabinets.



### PWR/TMPR12

12 VDC, 1.2 amp supply – board only

- Requires 16.5 VAC transformer
- Battery Back-up
- Provides tamper detection to guard against system attack



### PWR/TMPR12P

12 VDC, 1.2 amp supply in cabinet with transformer

- Provides tamper detection to guard against system attack

## PIP's



### PLUG-IN POWER SUPPLIES

- Transient Protection
- Auto resetting poly fuses
- Grounded
- LED power indicator

PIP12VDC: 12 VDC 1,000 mA  
 PIP24VDC: 24 VDC 1,000 mA  
 PIP12VAC: 12 VAC 40 VA  
 PIP16VAC: 16.5 VAC 40 VA  
 PIP24VAC: 24 VAC 40 VA

## Installation



**280**  
Weather resistant surface-mount back box



**281**  
Indoor flush mount back box



**285**  
Surface mount back box (black)



**286**  
Surface mount back box (chrome)

## Request to exit



### EZ-Rex

- Virtually infinite lifetime - switch life greater than 20,000,000 operations
- Totally weatherproof
- Solid state/No moving parts
- No mounting box required
- Operating force: 6 to 12 oz.

**CLOS**

**HOURS** \_\_\_\_\_ **am**

**phone** \_\_\_\_\_

# INTRUSION DETECTION

Vibration detectors and control panel interface keypads compliment burglar system installations. Intrusion Detection products are designed for use in residential, commercial and industrial security applications.

The frame mountable Viper 834L(WC) vibration detectors use piezoelectric sensors that respond to the conducted energy that is released from the breaking glass or the cutting or chiseling of walls. Our Intrusion Detection category includes the Partitioner, which is a 2-zone self contained backlit control system that is a perfect choice for smaller applications.

Vibration Detection

50



## Viper Plus 834 L & 834 LWC

The Viper Plus is a frame mountable solid state piezoelectric sensor with a custom ACIC microchip. The sensor responds to the directly conducted energy released by sawing, drilling, cutting or breaking glass and is suitable for most material. As a result, the Viper will not false alarm from any ambient sounds, or low frequency vibrations. Additionally, the Viper can be adjusted for single or double knock response to further increase false alarm rejections. There is also a Hi-Low sensitivity jumper that is used to increase or decrease the overall sensitivity and the potentiometer is used to fine-tune the adjustment.

### FEATURES

- Range: Up to a 10 ft. radius
- Hi-Low sensitivity adjustment
- Auto reset alarm relay
- Latching alarm LED
- Double-Knock for alarm verification
- Door/Window contact (834 LWC only)
- Indoor use only
- UL Listed

### SPECIFICATIONS

- Alarm Relay: SPST Form A contact
- Operating Voltage: 10.5-15 VDC
- Current Draw: 13 mA maximum
- Temperature tolerance: 0F to 120F
- Tamper circuit: Normally closed contact 50 mA @ 24 VDC
- Sensor dimensions: 3.35" x .90" x 1"
- Magnet dimensions: 3.35" x .39" x 1"-1.40" with spacers
- Magnetic contact (834LWC): 5/16" gap
- Uses Model 815 calibration tool



834L (White) / 834LBR (Brown)



834LWC

## 262B Partitioner

The 262B Partitioner is a low-cost self-contained 2-zone control system. A Form C alarm relay ties in easily to any standard alarm zone creating an independent sub-system. The contemporary plastic housing will mount directly to a single gang electrical box, or to most flat surfaces and blend nicely with any décor. The illuminated backlit keys will assist in those dimly lit applications, and the backlighting can be enabled or disabled by changing the position of a jumper.

### FEATURES

- Single-gang surface mount design
- Perimeter zone
- Interior zone
- Pre-alarm sounder
- 16 users
- Keypad programmable
- At home shunting
- Unique Touch Shunt mode
- Programmable Panic
- Form C 1 amp relay
- Built-in siren driver
- Indoor use only



262B

### SPECIFICATIONS

- Dimensions: 2.75" x 4.50" x 1.13"
- Operating voltage: 10.5-16 VDC
- Current draw: 50 mA @ 16 VDC Avg. 800 mA w/siren
- Ripple: 0.5 Volts
- Siren Driver: 8-ohms, 18 watts maximum
- Temperature tolerance: -20F to 130F

## Linear Training / Training Outline & Types

Technical Services is the group within Linear LLC that administers Continuing Education Unit (CEU) activities, courses, and programs. Technical training ensures the education and meets the goals of the dealers, distributors, and others who sell the Linear LLC branded products.

The technical training manager reviews the policies and procedures and ensures they meet accreditation requirements for CEUs. Linear LLC accredits their training through the National Burglar & Fire Alarm Association (NBFAA) service of the National Training School. The review process for every program occurs every two years at a minimum.

Linear will ensure the training provides adequate resources to support a positive learning environment. Instructors will be available to provide assistance and support to students.

When students meet the requirements for satisfactory completion of the training program, they are issued a certificate that indicates the title of the program, the name of the instructor, and the number of CEUs for the program. Training in Texas will result in an additional form with the instructors' numbers annotated for state requirements.

Linear maintains the records for approximately one year and can reissue certificates if desired. Information collected during training is only for the use of documenting students attending class and is not sold, released, or transferred for any other purposes.

Linear training is provided by qualified personnel with many years of experience in the field and competence in their topic of instruction. They also have knowledge and skill in instructional methods and learning processes. Feedback is encouraged and collected. Instruction is provided with no discrimination, and the trainers are not compensated for any activity other than for classroom instruction.

### Linear offers three types of training through [learnlinear.com](http://learnlinear.com)

#### **Type 1: Instructor Lead Training—On-Site Training**

We have product trainers and a sales management team who travel the U.S. to provide training at your facility or at a local distributor. This is a more traditional, classroom-style training option.

Linear programs are divided into four phases of courses. Many of Phase 3 and Phase 4 classes are NTS-approved for installers needing Continuing Education Units (CEUs).

#### **Phase 1: Marketing and Investment Strategies**

This presents how our products fit into the market segment. It will outline market share and profitability while showing projected future growth and outlook of product segments. It will show how to leverage your investment into our broad product offerings and maximize profitability.

#### **Phase 2: Sales Training**

This covers creating the right expectations for your customers. It goes over qualification questions to ask in order to qualify design to meet customer expectations. It also explains features and advantages by product, enabling you to differentiate products in a way your customer will understand.

#### **Phase 3: Design and Installation Training**

This is a brief product overview and explanation of installation and rough-in guidelines. The owner's manuals are reviewed (more than just packing material!). Configuration and system testing is illustrated. Instruction is given to show the customer how to use their new products in their home.

#### **Phase 4: Troubleshooting and Advanced Theory**

Very specific installation techniques are explained. Navigating troubleshooting guides and EMI and RFI influences are explored. Chronic problem installations and their root causes, as well as steps required that help avoid future call outs, are illustrated.

#### **Type 2: Instructor Lead /Computer-Based Training**

A product trainer remotely teaches a course using teleconferences and computer software to present the material. Since a live instructor is leading the training, these classes are scheduled.

Linear offers the ability to take most of the on-site training presentations over the Internet, with an instructor leading the training.

#### **Type 3: Self-Paced Training—Computer-Based**

This is similar to taking online college classes. From the convenience of either home or office, you can take classes at your own pace and return to previous sessions should you need to stop mid-class.

If you have any questions, feel free to e-mail at: [techsupport@linearcorp.com](mailto:techsupport@linearcorp.com) or call **1-800-421-1587** and ask for our training manager.

## Technical Support / Linear's Technical Services Support



Linear's Technical Services Department provides telephone support for our expanding product line. The group supports nearly 2,000 products in various types of installations and applications. Application engineers can assist dealers and installers with their technical questions regarding every Linear product.

The application engineers answer questions regarding equipment installation, programming, system design, troubleshooting, and inter-system compatibility. Questions could be about radio controls, security systems, access controls, door operators, gate operators, audio or video equipment, and accessories. Often, installers simply need fast help with their installation issues so they can complete the job and continue on to the next installation. Linear's quality and professional technical support staff provides that service.

The new extended Technical Services Department telephone service hours (5:00 am to 4:30 p.m. Pacific Time) will be of value to nationwide installers and company representatives alike. West Coast callers will be able to call as early as 5:00 am local time, and East Coast callers will be able to call as late as 7:30 p.m. local time.

Linear Technical Services provides direct access to the people who know Linear products best. To speak with a Linear expert, call 1-800-421-1587 and press 3.

## Manufacturing Facilities / State-of-the-Art Manufacturing Facility



Sound plans implemented with quality products and solutions to support them are critical to success in today's competitive global business environment. With a state-of-the-art manufacturing facility in China, Linear uses industry-leading manufacturing technologies that enable production of quality products that consistently raise the standard in home technology and provide a value you can depend on in today's competitive marketplace.

High-performance production tools, advanced technologies and techniques in design and testing, integrated circuitry, microchip, and surface mount technology, as well as the latest electronic component assembly and quality assurance techniques are features you can depend on from Linear manufacturing. Linear's Hong Kong manufacturing operation boasts a staff of more than 1,300 and is ISO 9001:2000 quality system certified.

*Several products included in this catalog are made in the U.S.A.*

## Distribution Centers / East & West Distribution Centers



To streamline order fulfillment and shorten delivery time for Linear distributors and dealers, Linear LLC maintains two fully stocked regional distribution facilities in Vista, California, and Summerville, South Carolina.

Linear's Western Distribution Center has 90,000 square feet with 19 shipping docks. Linear's Eastern Distribution Center boasts 175,000 square feet with 25 shipping docks and is the third largest UPS shipper in the Charleston, South Carolina, area.

Both warehouse locations are completely equipped with shipping, receiving, and quality control facilities, and they each stock tens of thousands of Linear products for security, entry systems, communications, audio/video/data, central vacuum systems, and personal emergency response. Each warehouse team receives dozens of cargo containers each month, processes hundreds of orders daily, and ships thousands of packages with Linear goods to worldwide destinations each day.

Model #	Description	Order #	Page
233	Magnetic Stripe Access Control Card Reader	0-233340	34
280	Weatherproof Surface-mount Backbox	0-200280	47
281	Indoor Flush-mount Backbox	0-200281	47
284	Accessory Relay	0-200284	36
285	Surface-mount Backbox, black	0-200250-B	47
286	Surface-mount Backbox, chrome	0-200250-C	47
293	Relay Board	0-219000	36
9432	xCeedID Smart Card 13.56 MHz Proximity Clam Shells	0-299060	23
9440	xCeedID Smart Card 13.56 MHz Proximity Clam Shells	0-299061	23
9532	xCeedID Smart Card 13.56 MHz Proximity Cards	0-299062	23
9540	xCeedID Smart Card 13.56 MHz Proximity Cards	0-299063	23
9640	xCeedID Smart Card 13.56 MHz Proximity Keytags	0-299064	23
2000-8EX	Output Expansion Module	0-294088	36
2000e	2000 Series e Style Flush-mount Backlit Access Control Keypad	0-294021	30
2000eM	2000 Series eM Style Flush-mount Durable Metal Access Control Keypad	0-294022	31
212i	Indoor Flush-mount Keypad	0-211111	30
212iLM-AL	Indoor / Outdoor Mullion-mount Weather Resistant Keypad, aluminum	0-231344	33
212iLM-BZ	Indoor / Outdoor Mullion-mount Weather Resistant Keypad, bronze	0-231345	33
212iLW	Indoor / Outdoor Flush-mount Weather Resistant Keypad	0-230722	32
212R	Indoor / Outdoor Surface-mount Ruggedized Keypad	0-211466	33
212SE	Indoor / Outdoor Surface-mount Weather Resistant Keypad	0-212140	34
212w	Indoor / Outdoor Flush-mount Weather Resistant Keypad	0-211222	31
232FX	Indoor / Outdoor Flush-mount Harsh Environmental Keypad	0-230760	32
232i	Indoor Flush-mount Keypad	0-213111	30
232iLM-AL	Indoor / Outdoor Mullion-mount Weather Resistant Keypad, aluminum	0-230800	33
232iLM-BZ	Indoor / Outdoor Mullion-mount Harsh Environmental Keypad, bronze	0-230801	33
232R	Indoor / Outdoor Surface-mount Ruggedized Keypad	0-213466	33
232SE	Indoor / Outdoor Surface-mount Weather Resistant Keypad	0-232140	34
232w	Indoor / Outdoor Flush-mount Weather Resistant Keypad	0-213222	31
242iLW	Indoor / Outdoor Flush-mount Weather Resistant Keypad	0-230727	32
262B	2-Zone Alarm System Partitioner	0-262130	51
834L	Viper Plus Piezoelectric Vibration Sensor, white	0-834000	50
834LBR	Viper Plus Piezoelectric Vibration Sensor, brown	0-834001	50
834LWC	Viper Plus Piezoelectric Vibration Sensor with Built-in Magnetic Contact	0-834010	50
CR500W	Secured Series Weatherproof Magnetic Card Reader	0-295340	21
CS26S	Wiegand 125 kHz Proximity Badge without Logo	0-299017	23
CS36S	Wiegand 125 kHz Proximity Badge without Logo	0-299016	23
CS36S-L	Wiegand 125 kHz Proximity Badge with Logo	0-299007	23
DTD	Hand-held Data Transfer Device	0-297011	17, 41, 44
DuoProx	Wiegand 125 kHz HID Compatible Proximity Cards	0-297201	23
EA-EV-C1001	Access Credential Cards	EA-EV-C1001	23
EA-EV-C1003	Access Credential Cards	EA-EV-C1003	23
EA-EV-C2001	Access Credential Cards	EA-EV-C2001	23
EA-EV-C4001	Access Credential Cards	EA-EV-C4001	23
EA-EV-C4003	Access Credential Cards	EA-EV-C4003	23
eMerge5000	eMerge 5000 System	230220	8

Model #	Desc	Order #	Page
eMerge50	eMerge 50 System	230219	6
eMerge MicroNode	eMerge MicroNode	230222	5
EZ-Rex	Easy Touch Request to Exit Button	0-291400	47
GR26S	Wiegand 125 kHz Proximity Cards	0-299018	23
GR36S	Wiegand 125 kHz Proximity Card	0-299008	23
GRMAG26S	Wiegand 125 kHz Proximity and Mag Stripe Cards	0-299019	23
GRMAG36S	Wiegand 125 kHz Proximity and Mag Stripe Cards	0-299009	23
HUBSWR	Hub Manager Professional Software	0-295011	11
IEI232-485	RS-232 to RS-485 Interface	0-295093	22
ISOProx	Wiegand 125 kHz HID Compatible Proximity Cards	0-297101	23
KP6840	Wiegand 125 kHz Proximity Reader with Keypad	0-299003	21
KT26S	Wiegand 125 kHz Proximity Key Fobs	0-299020	23
KT36S	Wiegand 125 kHz Proximity Key Fobs	0-299010	23
LS1	LS-1 Stand Alone Keypad Access Control Lockset		see page 45-40
LS2	LS2- Software Managed Keypad Access Control Lockset		see page 45-41
LS2P	LS2P- Software Managed Keypad and proximity Access Control Lockset		see page 45-41
M3-OM	Max3 Output Module	0-205661	15
M3M	Max 3 Modem Module for Dial Up Remote Site Management Applications	0-230556	22
MagCrd-100	Magnetic Striped Cards	0-200100	23
MagCrd-25	Magnetic Striped Cards	0-200025	23
MagHico-100	High Coercivity Magnetic Striped Cards	0-201000	23
MagHico-25	High Coercivity Magnetic Striped Cards	0-202525	23
Max3	Max 3 Single Door Access Control Panel	0-205673	10, 14
Max3-2400H	Max 3-2400H Single Door Access Control System Kit	0-205773	12
Max3 SYS	Max 3 Single Door Access Control System Kit	0-205600	12
Max3Mod	Max 3 Module Single Door Access Control Module	0-205671	15
Max3Mod-2400H	Max 3 Mod-2400H Single Door Access Control Expansion Kit	0-205771	12
Max3Mod EX	Max 3 Module Single Door Access Control Kit for System Expansion	0-205603	12
MaxiProx	Wiegand 125 kHz HID Proximity Reader	0-298070	21
Microprox	HID 125 kHz Proximity Tags	0-295244	23
MiniMax3	MiniMax3 Single Door Access Control Panel	0-205672	10, 14
MiniMax3-2400H	MiniMax 3-2400H Single Door Access Control System Kit	0-205772	12
MiniMax3 SYS	MiniMax 3 Single Door Access Control System Kit	0-205601	12
MiniProx-BK	Wiegand 125 kHz HID Proximity Reader, black	0-298066	21
MiniProx-GY	Wiegand 125 kHz HID Proximity Reader, gray	0-298000	21
MM6800	Wiegand 125 kHz Proximity Reader	0-299001	21
MR1824	Wiegand 125 kHz Proximity Reader	0-299004	21
PG 1224-3	Access Control Power Supply Board	0-291303	46
PIP12VAC	Plug-in 12 VAC Power Supply	0-291212	46
PIP12VDC	Plug-in 12 VDC Power Supply	0-291312	46
PIP16VAC	Plug-in 16.5 VAC Power Supply	0-291216	46
PIP24VAC	Plug-in 24 VAC Power Supply	0-291224	46
PIP24VDC	Plug-in 24 VDC Power Supply	0-291324	46
PKAC-110	AC PowerKey 110	0-290110	37
PKAC-220	AC PowerKey 220	0-290220	37
prox.pad	Wiegand 125 kHz Proximity Reader with Keypad	0-205676	20, 35

Model #	Description	Order #	Page
prox.pad plus	Integrated Proximity Reader and Controller with Keypad	0-205679	16
prox.pad plus IR	Integrated Proximity Reader and Controller with Keypad	0-205681	17
ProxCard II	Wiegand 125 kHz HID Compatible Proximity Cards	0-297401	23
ProxKey	Wiegand 125 kHz HID Compatible Proximity Key Fobs	0-297301	23
ProxPoint Plus-BK	Wiegand 125 kHz HID Proximity Reader, black	0-298065	21
ProxPoint Plus-GY	Wiegand 125 kHz HID Proximity Reader, gray	0-298064	21
ProxPro II-BK	Wiegand 125 kHz HID Proximity Reader, black	0-298069	21
ProxPro II-GY	Wiegand 125 kHz HID Proximity Reader, gray	0-298068	21
PrxCrd-100	Secured Series Indalla Proximity Cards	0-290100	23
PrxCrd-25	Secured Series Indalla Proximity Cards	0-290025	23
PW26S	Wiegand 125 kHz Proximity Wafers	0-299021	23
PW36S	Wiegand 125 kHz Proximity Wafers	0-299011	23
PWR/TMPR12	Access Control Power Supply with Tamper Module	0-291100	46
PWR/TMPR12P	Access Control Power Supply with Tamper Circuit in Cabinet	0-291200	46
SEG-1	Secured Ethernet Gateway	0-296005	22
SEG-M	Secured Ethernet Gateway Plug-in Module.	0-296006	22
SP6820	Wiegand 125 kHz Proximity Reader	0-299002	21
SR2400	Wiegand 125 kHz Proximity Reader	0-299000	21
SS-IM	Secured Series Interface Module	0-295701	22
SS-KP500R-WH	Secured Series Surface-mount Weatherproof Vandal-res. Access Control Keypad	0-295150	21
SS-KP500WP	Secured Series Surface-mount Weatherproof Vandal-res. Access Control Keypad	0-295140	21
SS-Modem	Plug-in Modem	0-230551	22
SS-PROXPOINT-BK	Secured Series Door Frame-mount Weatherproof HID Proximity Reader, black	0-295745	20
SS-PROXPOINT-GY	Secured Series Door Frame-mount Weatherproof HID Proximity Reader, gray	0-295743	20
SSW-FX	SSW Series FX Style Flush-mount Harsh Environment Access Control Keypad	0-230770	20
SSW-iLM-AL	SSW Series iLM Style Mullion-mount Backlit Access Control Keypad, aluminum	0-235161	20
SSW-iLM-BZ	SSW Series iLM Style Mullion-mount Backlit Access Control Keypad, bronze	0-235162	20
SSW-iLW	SSW Series iLW Style Flush-mount Weather Res. Backlit Access Control Keypad	0-230723	20
ThinLine II-BK	Wiegand 125 kHz HID Proximity Reader, black	0-298054	21
ThinLine II-GY	Wiegand 125 kHz HID Proximity Reader, gray	0-298053	21
TchChp-100	Touch Reader Chips	0-292100	23
TchChp-25	Touch Reader Chips	0-292025	23
USB-Serial	USB to Serial Converter	0-295097	22
WP644	Wiegand or Clock-and-Data Magnetic Stripe Card Reader	0-298079	21
XF1050	Wiegand 125 kHz Proximity Reader	0-299038	20
XF1060MF	Wiegand Smart Card 13.56 MHz Mini-Mullion Reader	0-299039	20
XF1060XX	Wiegand Smart Card 13.56 MHz Mini-Mullion Reader	0-299040	20
XF1100D	Wiegand 13.56 MHz & 125 kHz Multi-Frequency Mullion Reader	0-299031	20
XF1100D-PIV	Wiegand FIPS / PIV Multi-Frequency Mullion Reader	0-299035	20
XF1500D	Wiegand 13.56 MHz & 125 kHz Multi-Frequency Wall-mount Reader	0-299032	20
XF1550	Wiegand 125 kHz Proximity Reader	0-299041	20
XF2100D	Wiegand 13.56 MHz & 125 kHz Multi-Frequency Mid-range Reader	0-299033	20
XF2100D-PIV	Wiegand FIPS / PIV Multi-Frequency Mid-range Reader	0-299036	20
XF2110D	Wiegand 13.56 MHz & 125 kHz Multi-Frequency Mid-range Reader w/Keypad	0-299034	20
XF2110D-PIV	Wiegand FIPS / PIV Multi-Frequency Mid-range Reader w/Keypad	0-299037	20

Ask your Sales Representative about Linear's full line of Access Control Products



WOR Wiegand  
Output Receiver

#### Radio Controls

- Commercial Radio Controls
- Extended Range Radio Controls
- Wireless Keypads
- Gate Safety Edge Transmitters
- Radio Control Accessories



AE2000Plus  
Commercial Access System

#### Telephone Entry

- Door/Gate Access Controllers
- Entry System Cameras
- Commercial Telephone Entry with Access Control
- Residential Telephone Entry Systems
- Access Control Accessories



ACT-31D & ACT-34D  
Trans Prox Transmitter

#### Access Transmitters

- Multi-Code Radio Controls
- Allstar Radio Controls
- MegaCode Radio Controls
- Delta-3 Radio Controls
- MVP Radio Controls



VS-GSWG Commercial  
Swing Gate Operator

#### Gate Operators

- Swing Gate Operators
- Slide Gate Operators
- Barrier Gate Operators
- Industrial Gate Operators
- Variable Speed Operators



Model-H Jackshaft  
Commercial Door Operator

#### Door Operators

- Drawbar Operators
- Jackshaft Operators
- Gear Reduced Operators
- Extended Duty Operators
- Hazardous Location Operators

Visit [www.linearcorp.com](http://www.linearcorp.com)

