



Barracuda™

Broadcast & Broadband Racks

 **electrorack**

A Group brand

 **legrand®**

Barracuda™ broadcast & broadband racks

Electrorack's BARRACUDA Broadcast and Broadband Racks are the ideal foundation to keep pace with continually evolving Broadcast and Broadband environments. Today's cable providers and telcos are racing to gain market share and complete their triple-play offerings of Video, Voice, and Data. Technologies such as Video On Demand (VOD), Voice Over Internet Protocol (VOIP), Internet Protocol Television (IPTV) High Definition (HD) and Ad Insertion require new hardware and infrastructure build-outs. Strategically managing these build-outs in a cost-effective manner is critical to ensure profitability. These build-outs require an adaptable, robust rack platform to manage today's and tomorrow's hardware, power, grounding, isolation, cabling, and thermal issues associated with the new technologies - **BARRACUDA**.

Features

- Ships completely configured to your requirements saving you up to 1-2 hours installation per rack*
- Facility interface solutions - anchoring & cabling
- Base solutions for concrete and raised floors
- Integrated grounding, isolation and cable management offerings
- UBC Seismic Zone 4 compliant
- 14 GA fully-welded cold-rolled steel - 2,000 lbs. load
- Tapped #10-32 or 0.375 square hole EIA angles
- Limited Lifetime Guarantee

* Estimate is typical for larger installed projects with integrated components.

the new standard in triple play racks

Facility Types

- Cable Headends
- IP Video Super Hub Offices
- IP Video Hub Offices
- IP Serving Offices
- Satellite Uplink
- Video Operations Centers
- TV Broadcast Centers
- Central Offices

Applications

- VoIP - Voice over IP
- VOD - Video On Demand
- IPTV - Internet Protocol TV
- Ad Insertion
- HD - High-Definition TV
- DTV - Digital TV
- SD - Standard-Definition TV

Rack Infrastructure Requirements

- Hardware Compatibility
- Power Distribution
- Isolation & Grounding
- Thermal Management/Airflow
- Cable Management
- Anchoring

Triple Play

video
voice
data



Customer Rack Criteria

- Reduce Overall Costs
- Simplify Ordering Process
- Speed Installation/Reduce Labor
- Minimize On-site Modifications/Adjustments
- Improve Equipment Accessibility
- Interface with Building Structure/Systems
- Support/Incorporate Hardware Changes



Barracuda

Racks for Video, Voice and Data

Table of Contents

FEATURES & OPTIONS	4-6	
BUILD YOUR 'CUDA	7	
FRAMES	8-9	
EIA ANGLES & HARDWARE	10-14	
BASES	15-17	
DOORS & SIDE PANELS	18-20	
TOP PANELS	21-22	
FILLER PANELS	23	
CABLE MANAGEMENT	24-25	
SHELVES	26	
GROUNDING & ISOLATION	27	
BASIC & METERED PDU'S	28-29	
POWER STRIPS	30	
ADDITIONAL SOLUTIONS	31	

features & options (all sizes)

REDUCE INSTALLATION
LABOR & OVERALL COSTS



COMPLETE INTEGRATION

Components and accessories are shipped completely installed and ready for use, reducing deployment time and overall costs while minimizing packaging waste. Power, Grounding, Chassis Angles, Cable Management, Filler Panels, etc. We'll install it where you want it!



INSTALLATION-READY GROUND POINTS

Eliminate on-site drilling and grinding with our pre-masked and pre-drilled 1/4" double lug holes on the top rear of each frame. 1/4" studs for double lug connectors are at the base of each frame. We'll even install cut-to-length ground straps so only a connection to the building ground is required!

IMPROVE EQUIPMENT
ACCESS & SPACE UTILIZATION



SPLIT DUAL REAR DOORS

Minimize aisle blockage utilizing our optional split dual rear doors. Split doors are very effective in tight aisle conditions, allowing maintenance or loading without removing the doors.



RACK UNIT LABELS & PRE-SET MOUNTING ANGLE SPACING

Adhesive or removable magnetic U labels easily identify equipment locations while our infinitely-adjustable EIA mounting angles ship at your pre-set specified distance. Angles also include a clearance hole for easy ganging of multiple units.



180 DEGREE DOOR SWING - SELF-CONTAINED HINGES

Surface-mount doors utilize 180 degree hinges allowing doors to open flat against neighboring doors, maximizing equipment access - and there's no removable pins to lose!

INTERFACE WITH BUILDING
STRUCTURE & CABLING



OVERHEAD CABLE LADDER SUPPORT

Our overhead cabling support interface is designed to mount directly to the frame tops without drilling. The Unistrut® design allows infinite mounting and includes frame mounting hardware. 5/8"-11 thread stand-off insulators are included with each kit.



INTEGRATED CABLE LADDER

Mounting directly to the frame top, the modular Integrated Cable Ladder is an ideal, cost-effective alternative for smaller or low ceiling applications.

ADAPTABLE PLATFORM
TO KEEP PACE WITH TECHNOLOGY



HARDWARE COMPATIBILITY

Our infinitely depth-adjustable EIA mounting angles and wide variety of styles (including traditional square hole server angles) ensure we can mount today's and tomorrow's hardware. Add additional angles or vertical accessories anywhere along the front-to-back Unistrut® members.



THERMAL PROTECTION

Proper airflow is imperative to achieve optimal hardware operating temperatures and prevent overheating. A selection of full-mesh doors, fans and blanking panels are available to direct airflow.

EXPECT MORE

Electrorack constantly works to improve the customer's experience at all levels. We work to design better products with improved quality and functionality while reducing costs and delivery times. Barracuda is the result of our customer's input and our extensive experience with Broadcast & Broadband clients. Building a better, more practical rack - **BARRACUDA**.



INTEGRATED ANCHORING HOLES & LEVELER NUTS

Anchoring holes in frames eliminate the need for on-site drilling where metal shavings can create hardware havoc. Integrated leveler nuts in the frame allow optional levelers to be installed without the purchase of a separate base.



FORMED CABLE ENTRY EDGES

Fully formed top and bottom frame openings eliminate sharp edges and provide a smooth radius to minimize cable chafing while speeding cable pulling and installation.



SIMPLIFIED ORDERING PROCESS- SINGLE-DIGIT PART NUMBERS

On large projects, our application specialists will determine your overall requirements for each rack in your layout and assign it a unique part number with a revision level. This reduces order processing and receiving time, and simplifies future orders.

123456A

FULLY OPEN TOP & BOTTOM FRAMES

Maximizing the top and bottom openings allows cables to enter directly into vertical lacing, eliminating cable jogs. No caster mounting plates to interfere with cable openings at the bottom.



CABLING H-PANEL

Innovative H-panel design allows top to be installed and removed at any time without impacting cabling. H-panels eliminate cable "fishing" while grommet edges protect cables.



ERGONOMIC 2-PIECE SIDE PANELS

Multiple lightweight panels are easy to remove, handle, store and replace, reducing ergonomic strain created by 1-piece panels. Locks are optional.

ANCHORING HARDWARE & SHIM KITS

Electrorack offers pre-configured anchoring hardware designed to work with Barracuda. Shim kits compensate for uneven flooring to provide a level installation.



BASES FOR CONCRETE OR RAISED FLOORS

A wide base selection addresses either floor type in stand-alone or ganged applications. Bases for anchoring, cabling and mobility are available.



FRAME ISOLATION KITS

Isolation bushings and pads specifically designed for Barracuda provide pre-fitted electrical isolation, eliminating alternate sourcing and field modifications. Stand-off insulators are also available for overhead cabling isolation.

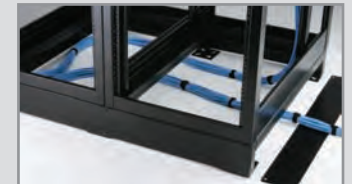

POWER OPTIONS

Today's increased processing speeds require more power distributed to each rack. Managing the power and minimizing the interference with the rack equipment and airflow is critical. Offerings of 120V and 208V in 15, 20 and 30 amps are available.



LIMITED LIFETIME WARRANTY

We stand behind our products and workmanship, and design them to last throughout your ownership.

CLEAN, AESTHETIC APPEARANCE

Barracuda corner posts are only punched with holes when doors are ordered. Units without doors are not punched, providing a clean, showcase appearance.



features & options

Unique for 26" Wide Barracuda

Electrorack's 26" Wide Barracuda enclosures utilize a unique, 4-Unistrut® frame system. This flexible design allows split vertical mounting angles to move independently to accommodate varying-depth equipment. Additionally, the 26" frame width provides extra cabling space on each side for higher-density switching and cabling applications. And to top it all off, you can house 19", 23" or both 19" and 23" EIA equipment in the same rack!

26" Wide Barracuda Highlights

- Mount 19", 23" or both 19" & 23" EIA equipment in the same rack
- 4-strut construction improves flexibility and structural integrity
- Split vertical mounting angles move independently to accommodate varying-depth equipment in the same rack
- 26"-wide footprint provides additional space for high-density cabling applications and power
- Wider mounting angles minimize impact of vertical power and cable bundles on airflow and allows access to mounting holes
- Integrated holes in the 19" vertical mounting angles accommodate 1/4-turn cable rings (ordered separately) as required
- Built-to-order based on airflow, cabling or expansion requirements, or as an open 4-post rack
- Gang to 22"W, 24"W or 26"W Barracuda Frames to maximize your space-to-equipment ratio



NETWORKING SWITCH RACK

An ideal solution to manage the additional cables associated with networking switches. Standard angles center the switch while complete offset angles are available (contact your Electrorack sales person) for managing all cables to one side. Optional side-mount airflow baffles to manage side-to-side airflow are available upon request.



4-STRUT FRAME SYSTEM

The versatile 4-strut frame system offers infinite adjustment of two independent sets (top and bottom) of equipment angles while improving structural integrity.



HIGH-DENSITY CABLE MANAGEMENT

The 19" equipment mounting angles provide space to route cables outside the equipment mounting area. Keeping the cables outside the equipment improves airflow.



MIX 19" & 23" EIA EQUIPMENT

Mount both 19" and 23" equipment in the same rack utilizing our innovative split mounting angle system.



SPLIT MOUNTING ANGLES

Split equipment mounting angles allow varying-depth equipment to be mounted in the same rack. Independently adjust the top or bottom set of mounting angles to appropriate depth.



EQUIPMENT MOUNTING HOLE ACCESS

Our 19" vertical mounting angles center the equipment in the wider 26" frame providing ample clearance to access the equipment mounting holes, even with deeper vertical power mounted.

INTEGRATED CABLE RING MOUNTING

Adjustable vertical mounting angles include mounting holes to accommodate 1/4-turn cable managers. Rings are sold separately.



build your 'cuda

build your barracuda

1

SELECT FRAME SIZE

- | | | |
|---------------------------------|-------------------------|-------------------|
| • Height - Rack Units (Overall) | • Depth - Overall Frame | • Width - Overall |
| - 40U (75.50") | - 30.88" | - 22.0" |
| - 42U (79.00") | - 36.13" | - 24.0" |
| - 45U (84.25") | - 39.63" | - 26.0" |
| - 48U (89.50") | - 44.88" | |
| - 50U (93.00") | | |



2

SELECT MOUNTING ANGLE STYLE (MATCH FRAME HEIGHT)

- | | |
|--|-----------------------------|
| • 0.625" Offset Profile (shown at right) | • L-shape Profile |
| - Tapped #10-32/Tapped #10-32 | - Tapped #10-32/0.281 Clear |
| - Tapped #10-32/0.281 Clearance | - 0.375 Square/0.375 Square |
| - 0.375" Square/0.375" Square | |
| • Order hardware & rack unit labels separately | |



3

SELECT BASE STYLE (BASES ARE OPTIONAL)

- | | |
|-----------------------------------|----------------------------------|
| • Single Bay | • Single or Multiple Bay |
| - Levelers Only - Mount in Frame | - 5" High Cabling Stand |
| - 3" Riser Base | - Sub-floor Bases (raised floor) |
| - 3" Riser with Levelers | 12", 18" or 24" High |
| - 3" Riser with Caster & Levelers | |



4

SELECT TOP PANELS, DOORS & SIDES (ALL ARE OPTIONAL)

- | | |
|---------------------------------------|---|
| • Top Panels - Full, Shorter, 12.25"D | • Doors - Surface Mount |
| - Solid | - Solid |
| - Vented | - Vented or Plexi w/Vents |
| - Dual Fan (460 CFM) | - Mesh |
| - Single Fan (550 CFM) | • Side Panels - Solid (Locks or No locks) |
| - Cabling Panels | |



5

SELECT ACCESSORIES & COLOR

- | | |
|---|-------------------------------|
| • Cable Management | • Colors - Standard or Custom |
| • Power, Grounding & Isolation | |
| • Shelves, Chassis Angles & Filler Panels | |



frames

22" W (19" EIA) Frames



- EIA mounting angles ordered separately
- Select optional top, base, doors & sides separately
- Build-to-order based on airflow, cabling or expansion requirements or as an open 4-post rack
- Static frame load capacity is 2,000 lbs.
- Fully welded construction – 14 GA (0.075") steel
- Integrated 1/4-20 ground studs (2) on 3/4" centers at base of enclosure to accept double lug connector
- Includes holes on side of frame for ganging multiple frames together. Order multi-bay hardware kit (B-MBK) separately
- Includes 1/2-13 threads in frame bottom for optional levelers - eliminates requirement of a separate base for leveling
- Top corners of frame include holes for connecting 5/8" threaded rod (not included) to support overhead cable ladder
- Flat frame bottoms include (4) 0.75" diameter holes for attaching bases or anchoring directly to floor
- Custom sizes are available upon request - contact your application specialist for further details

Overall Height	Overall Depth	Overall Width	Part Number
40U (75.50")	30.88"	22.0"	B-F4030-#
	36.13"	22.0"	B-F4036-#
	39.63"	22.0"	B-F4039-#
	44.88"	22.0"	B-F4044-#
42U (79.00")	30.88"	22.0"	B-F4230-#
	36.13"	22.0"	B-F4236-#
	39.63"	22.0"	B-F4239-#
	44.88"	22.0"	B-F4244-#
45U (84.25")	30.88"	22.0"	B-F4530-#
	36.13"	22.0"	B-F4536-#
	39.63"	22.0"	B-F4539-#
	44.88"	22.0"	B-F4544-#
48U (89.50")	30.88"	22.0"	B-F4830-#
	36.13"	22.0"	B-F4836-#
	39.63"	22.0"	B-F4839-#
	44.88"	22.0"	B-F4844-#
50U (93.00")	30.88"	22.0"	B-F5030-#
	36.13"	22.0"	B-F5036-#
	39.63"	22.0"	B-F5039-#
	44.88"	22.0"	B-F5044-#

Specify Color: "1" = White; "2" = Black; "3" = Charcoal; "5" = Flint Grey; "6" = Royal Blue; "9" = Platinum (see Page 31 for finishes)

24" W (19" EIA) Frames



- EIA mounting angles ordered separately
- Select optional top, base, doors & sides separately
- Build-to-order based on airflow, cabling or expansion requirements or as an open 4-post rack
- Static frame load capacity is 2,000 lbs.
- Fully welded construction – 14 GA (0.075") steel
- Integrated 1/4-20 ground studs (2) on 3/4" centers at base of enclosure to accept double lug connector
- Includes holes on side of frame for ganging. Order multi-bay hardware kit (B-MBK) separately
- Includes 1/2-13 threads in frame bottom for optional levelers - eliminates separate base requirement for leveling
- Top corners of frame include holes for connecting 5/8" threaded rod (not included) to support overhead cable ladder
- Flat frame bottoms include (4) 0.75" diameter holes for attaching bases or anchoring directly to floor
- Custom sizes are available upon request - contact an application specialist for further details

Overall Height	Overall Depth	Overall Width	Part Number
40U (75.50")	30.88"	24.0"	B-F244030-#
	36.13"	24.0"	B-F244036-#
	39.63"	24.0"	B-F244039-#
	44.88"	24.0"	B-F244044-#
42U (79.00")	30.88"	24.0"	B-F244230-#
	36.13"	24.0"	B-F244236-#
	39.63"	24.0"	B-F244239-#
	44.88"	24.0"	B-F244244-#
45U (84.25")	30.88"	24.0"	B-F244530-#
	36.13"	24.0"	B-F244536-#
	39.63"	24.0"	B-F244539-#
	44.88"	24.0"	B-F244544-#
48U (89.50")	30.88"	24.0"	B-F244830-#
	36.13"	24.0"	B-F244836-#
	39.63"	24.0"	B-F244839-#
	44.88"	24.0"	B-F244844-#
50U (93.00")	30.88"	24.0"	B-F245030-#
	36.13"	24.0"	B-F245036-#
	39.63"	24.0"	B-F245039-#
	44.88"	24.0"	B-F245044-#

Specify Color: "1" = White; "2" = Black; "3" = Charcoal; "5" = Flint Grey; "6" = Royal Blue; "9" = Platinum (see Page 31 for finishes)

26" W (19" or 23" EIA) Frames



- EIA mounting angles ordered separately
- Select optional top, base, doors & sides separately
- Build-to-order based on airflow, cabling or expansion requirements or as an open 4-post rack
- Static frame load capacity is 2,000 lbs.
- Fully-welded construction – 14 GA (0.075") steel
- Integrated 1/4-20 ground studs (2) on 3/4" centers at base of enclosure to accept double lug connector
- Includes holes on side of frame for ganging - order multi-bay hardware kit (B-MBK) separately
- Includes 1/2-13 threads in frame bottom for optional levelers - eliminates separate base requirement for leveling
- Top corners of frame include holes for connecting 5/8" threaded rod (not included) to support overhead cable ladder
- Flat frame bottoms include (4) 0.75" diameter holes for attaching bases or anchoring directly to floor
- Custom sizes are available upon request - contact an application specialist for further details

frames

Overall Height	Overall Depth	Overall Width	Part Number
40U (75.50")	30.88"	26.0"	B-F264030-#
	36.13"	26.0"	B-F264036-#
	39.63"	26.0"	B-F264039-#
	44.88"	26.0"	B-F264044-#
42U (79.00")	30.88"	26.0"	B-F264230-#
	36.13"	26.0"	B-F264236-#
	39.63"	26.0"	B-F264239-#
	44.88"	26.0"	B-F264244-#
45U (84.25")	30.88"	26.0"	B-F264530-#
	36.13"	26.0"	B-F264536-#
	39.63"	26.0"	B-F264539-#
	44.88"	26.0"	B-F264544-#
48U (89.50")	30.88"	26.0"	B-F264830-#
	36.13"	26.0"	B-F264836-#
	39.63"	26.0"	B-F264839-#
	44.88"	26.0"	B-F264844-#
50U (93.00")	30.88"	26.0"	B-F265030-#
	36.13"	26.0"	B-F265036-#
	39.63"	26.0"	B-F265039-#
	44.88"	26.0"	B-F265044-#

Specify Color: "1" = White; "2" = Black; "3" = Charcoal; "5" = Flint Grey; "6" = Royal Blue; "9" = Platinum (see Page 31 for finishes)

frame dimensions

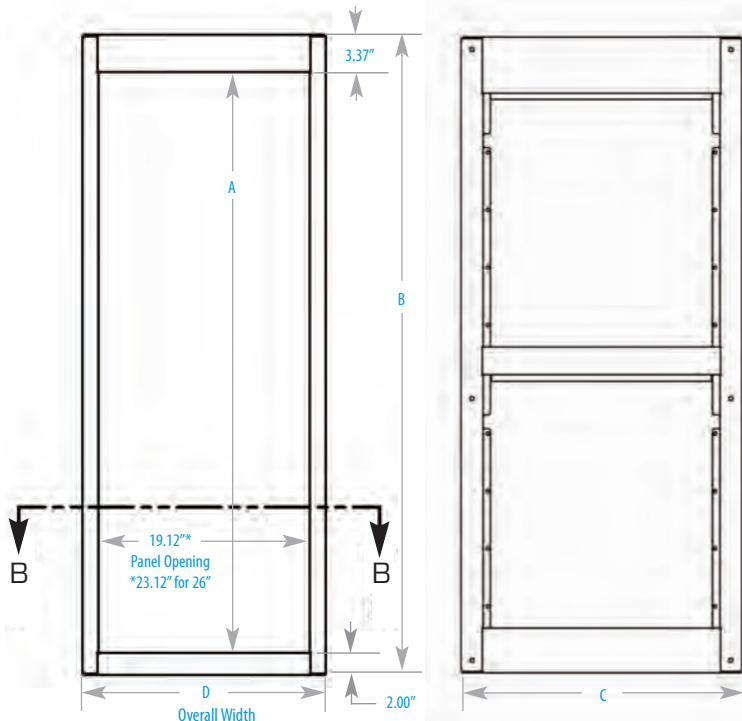
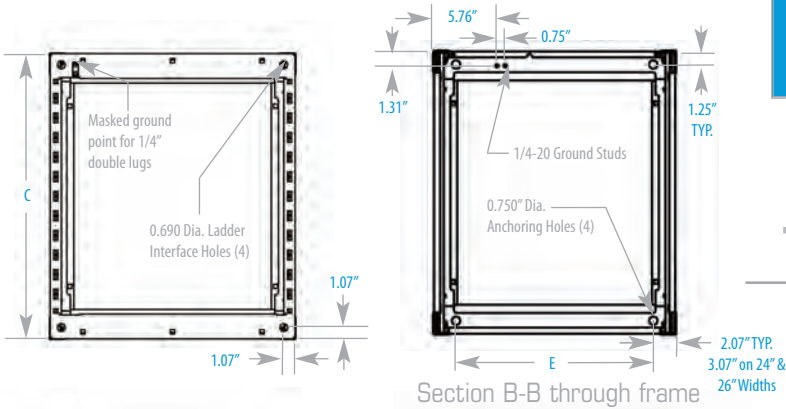

height	Rack Units	Vertical Panel Opening A	Overall Height B
	40U	70.13"	75.50"
42U	73.63"	79.00"	
45U	78.88"	84.25"	
48U	84.13"	89.50"	
50U	87.63"	93.00"	

width	Overall Width D	Horizontal Panel Opening	EIA	Anchor Hole Width E
	22.00"	19.12"*	19"	17.85"
	24.00"	19.12"*	19"	17.85"
	26.00"	23.12"	19 or 23"	19.85"

depth	Overall Depth C	Maximum Mounting Angle Spacing
	30.88"	29.63"
	36.13"	34.88"
	39.63"	38.38"
44.88"	43.63"	

*Clear dimension between EIA angles (ordered separately) is 17.81".

mounting angles-offset

Mounting Angles - Offset

- Compatible with chassis support angles
- 12 GA (0.105") steel construction
- Height must match frame height
- Part numbers include (2) EIA mounting angles and hardware to mount to Unistrut® members of frame
- #10-32 tapped holes allow fast installation of equipment with screws only (ordered separately) – see Page 14
- 0.281 clearance holes require clip nut hardware and screws (ordered separately) for mounting equipment - see Page 14
- 0.375 square holes require cage nut hardware and screws - ideal for servers
- Mounting angles include holes for connection of double lug groundstraps
- Color: painted black or plated clear zinc

offset	22"W (19" EIA)	Frame Width /EIA	Height (U)	Tapped #10-32 (tapped #10-32 side holes)	Tapped #10-32 (0.281 clearance side holes)	0.375 Square Holes (0.375 sq. side holes)	
				40U	B-MA40C-TT-#	B-MA40C-TC-#	B-MA40C-SS-#
				42U	B-MA42C-TT-#	B-MA42C-TC-#	B-MA42C-SS-#
				45U	B-MA45C-TT-#	B-MA45C-TC-#	B-MA45C-SS-#
				48U	B-MA48C-TT-#	B-MA48C-TC-#	B-MA48C-SS-#
				50U	B-MA50C-TT-#	B-MA50C-TC-#	B-MA50C-SS-#

offset	24"W (19" EIA)	Frame Width /EIA	Height (U)	Tapped #10-32 (tapped #10-32 side holes)	Tapped #10-32 (0.281 clearance side holes)	0.375 Square Holes (0.375 sq. side holes)	
				40U	B-MA2440C-TT-#	B-MA2440C-TC-#	B-MA2440C-SS-#
				42U	B-MA2442C-TT-#	B-MA2442C-TC-#	B-MA2442C-SS-#
				45U	B-MA2445C-TT-#	B-MA2445C-TC-#	B-MA2445C-SS-#
				48U	B-MA2448C-TT-#	B-MA2448C-TC-#	B-MA2448C-SS-#
				50U	B-MA2450C-TT-#	B-MA2450C-TC-#	B-MA2450C-SS-#

Specify Color: "2" = Black; "0" = Clear Zinc

Full-Height Split 19" EIA Mounting Angle Sets

- Use only on 26" wide frames
- Use offset style with chassis angles
- 12 GA (0.105") steel construction
- Height must match frame height
- Sets include (4) EIA half-height mounting angles - ex. (2) 20U top & (2) 20U bottom for 40U set and hardware to mount to frame
- #10-32 tapped holes allow fast installation of equipment with screws only
- 0.281 clearance holes require clip nut hardware and screws
- 0.375 square holes require cage nut hardware and screws - ideal for servers
- Color: painted black or plated clear zinc

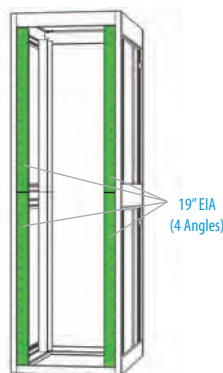

offset	26"W (19" EIA)	Frame Width/ EIA Rack-mount	Fits Frame Height (U)	Tapped #10-32 (Tapped #10-32 side holes)	0.375 Square Hole (0.375 square side holes)	
				40U	B-MAS2640C-TT-#	B-MAS2640C-SS-#
				42U	B-MAS2642C-TT-#	B-MAS2642C-SS-#
				45U	B-MAS2645C-TT-#	B-MAS2645C-SS-#
				48U	B-MAS2648C-TT-#	B-MAS2648C-SS-#
				50U	B-MAS2650C-TT-#	B-MAS2650C-SS-#

Specify Color: "2" = Black; "0" = Clear Zinc

mounting angles-offset

Half-Height 19" EIA Mounting Angle Sets

- Use only on 26" wide frames
- Use offset style with chassis angles
- 12 GA (0.105") steel construction
- Half-height sets for combo 19" & 23" racks
- Sets include (2) EIA half-height mounting angles - ex. (2) 20U angles in 20U set - mount top or bottom on 40U frame and hardware to mount to frame
- #10-32 tapped holes allow fast installation of equipment with screws only
- 0.375 square holes require cage nut hardware and screws - ideal for servers
- 0.281 clearance holes require clip nut hardware and screws
- Color: painted black or plated clear zinc

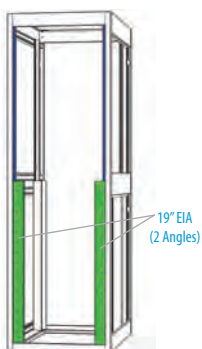

offset				
	Frame Width/ EIA Rack-mount	Height (U)/Fits Frame Height	Tapped #10-32 (Tapped #10-32 side holes)	0.375 Square Hole (0.375 square side holes)
	26"W (19" EIA)	20U (40U)	B-MA2620C-TT-#	B-MA2620C-SS-#
		21U (42U)	B-MA2621C-TT-#	B-MA2621C-SS-#
		22U (45U)	B-MA2622C-TT-#	B-MA2622C-SS-#
		23U (45U)	B-MA2623C-TT-#	B-MA2623C-SS-#
		24U (48U)	B-MA2624C-TT-#	B-MA2624C-SS-#
25U (50U)	B-MA2625C-TT-#	B-MA2625C-SS-#		

Specify Color: "2" = Black; "0" = Clear Zinc

Full-Height Split 23" EIA Mounting Angle Sets

- Use only on 26" wide frames
- Use offset style with chassis angles
- 12 GA (0.105") steel construction
- Height must match frame height
- Sets include (4) EIA half-height mounting angles - ex. (2) 20U top & (2) 20U bottom for 40U set and hardware to mount to frame
- #10-32 tapped holes allow fast installation of equipment with screws only
- 0.281 clearance holes require clip nut hardware and screws
- 0.375 square holes require cage nut hardware and screws - ideal for servers
- Color: painted black or plated clear zinc

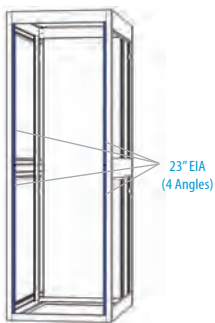

offset				
	Frame Width/EIA	Fits Frame Height (U)	Tapped #10-32 (Tapped #10-32 side holes)	0.375 Square Hole (0.375 square side holes)
	26"W (23" EIA)	40U	B-MAS40C-TT-#	B-MAS40C-SS-#
		42U	B-MAS42C-TT-#	B-MAS42C-SS-#
		45U	B-MAS45C-TT-#	B-MAS45C-SS-#
		48U	B-MAS48C-TT-#	B-MAS48C-SS-#
50U		B-MAS50C-TT-#	B-MAS50C-SS-#	

Specify Color: "2" = Black; "0" = Clear Zinc

Half-Height 23" EIA Mounting Angle Sets

- Use only on 26" wide frames
- Use Offset style with Chassis Angles
- 12 GA (0.105") steel construction
- Half-height sets for combo 19" & 23" racks
- Sets include (2) EIA Half-height Mounting Angles - ex. (2) 20U angles in 20U set - mount top or bottom on 40U frame and hardware to mount to frame
- #10-32 tapped holes allow fast installation of equipment with screws only
- 0.281 clearance holes require clip nut hardware and screws
- 0.375 square holes require cage nut hardware and screws - ideal for servers
- Color: Painted Black or Plated Clear Zinc

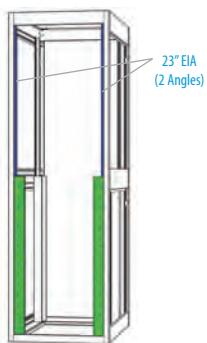

offset				
	Frame Width/EIA	Height (U)/Fits Frame Height	Tapped #10-32 (Tapped #10-32 side holes)	0.375 Square Hole (0.375 square side holes)
	26"W (23" EIA)	20U (40U)	B-MA20C-TT-#	B-MA20C-SS-#
		21U (42U)	B-MA21C-TT-#	B-MA21C-SS-#
		22U (45U)	B-MA22C-TT-#	B-MA22C-SS-#
		23U (45U)	B-MA23C-TT-#	B-MA23C-SS-#
		24U (48U)	B-MA24C-TT-#	B-MA24C-SS-#
25U (50U)	B-MA25C-TT-#	B-MA25C-SS-#		

Specify Color: "2" = Black; "0" = Clear Zinc

mounting angles - L-shaped

Mounting Angles - L-shaped

- Not compatible with chassis support angles
- 12 GA (0.105") cold-rolled steel construction
- Height must match frame height
- Part numbers include (2) EIA mounting angles and hardware to mount to Unistrut® members of frame
- #10-32 tapped holes allow fast installation of equipment with screws only (ordered separately) see Page 14
- 0.281 clearance holes require clip nut hardware and screws (ordered separately) for mounting equipment - see Page 14
- 0.375 square holes require cage nut hardware and screws (ordered separately) for mounting equipment - see Page 14 - ideal for server mounting
- Mounting angles include holes for connection of double lug groundstraps
- Side of EIA angles have slots for cable lacing
- Color: painted black or plated clear zinc

L-shaped							
				Frame Width/ EIA	Height (U)	Tapped #10-32 (0.281 clearance side holes)	0.375 square holes (0.375 square side holes)
				22"W (19" EIA)	40U	B-MA40L-TC-#	B-MA40L-SS-#
					42U	B-MA42L-TC-#	B-MA42L-SS-#
					45U	B-MA45L-TC-#	B-MA45L-SS-#
					48U	B-MA48L-TC-#	B-MA48L-SS-#
50U	B-MA50L-TC-#	B-MA50L-SS-#					

L-shaped							
				Frame Width/ EIA	Height (U)	Tapped #10-32 (0.281 clearance side holes)	0.375 square holes (0.375 square side holes)
				24"W (19" EIA)	40U	B-MA2440L-TC-#	B-MA2440L-SS-#
					42U	B-MA2442L-TC-#	B-MA2442L-SS-#
					45U	B-MA2445L-TC-#	B-MA2445L-SS-#
					48U	B-MA2448L-TC-#	B-MA2448L-SS-#
50U	B-MA2450L-TC-#	B-MA2450L-SS-#					

Specify Color: "2" = Black; "0" = Clear Zinc

Full-Height Split 19" EIA Mounting Angle Sets

- Use only on 26" wide frames
- 12 GA (0.105") steel construction
- Height must match frame height
- Sets include (4) EIA half-height mounting angles - ex. (2) 20U top & (2) 20U bottom for 40U set and hardware to mount to frame
- #10-32 tapped holes allow fast installation of equipment with screws only
- 0.281 clearance holes require clip nut hardware and screws
- 0.375 square holes require cage nut hardware and screws - ideal for servers
- Color: painted black or plated clear zinc

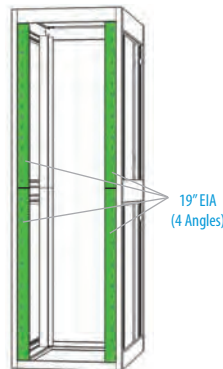

L-shaped							
				Frame Width/EIA	Fits Frame Height (U)	Tapped #10-32 (0.281 clearance side holes)	0.375 Square Hole (0.375 square side holes)
				26"W (19" EIA)	40U	B-MAS2640L-TC-#	B-MAS2640L-SS-#
					42U	B-MAS2642L-TC-#	B-MAS2642L-SS-#
					45U	B-MAS2645L-TC-#	B-MAS2645L-SS-#
					48U	B-MAS2648L-TC-#	B-MAS2648L-SS-#
50U	B-MAS2650L-TC-#	B-MAS2650L-SS-#					

Specify Color: "2" = Black; "0" = Clear Zinc

mounting angles - L-shaped

Half-Height 19" EIA Mounting Angle Sets

- Use only on 26" wide frames
- 12 GA (0.105") steel construction
- Half-height sets for combo 19" & 23" racks
- Sets include (2) EIA half-height mounting angles - ex. (2) 20U angles in 20U set - mount top or bottom on 40U frame and hardware to mount to frame
- #10-32 tapped holes allow fast installation of equipment with screws only
- 0.281 clearance holes require clip nut hardware and screws
- 0.375 square holes require cage nut hardware and screws - ideal for servers
- Color: painted black or plated clear zinc

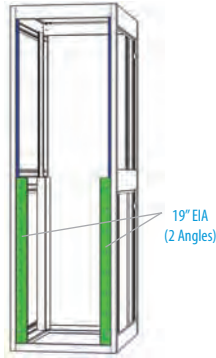

Top View		#10-32 Tapped Holes	0.281 Clear Holes	0.375" Square Holes
Frame Width/EIA	Height (U)/Fits Frame Height	Tapped #10-32 (0.281 clearance side holes)	0.375 Square Hole (0.375 square side holes)	
L-Shaped 26"W (19" EIA)	20U (40U)	B-MA2620L-TC-#	B-MA2620L-SS-#	
	21U (42U)	B-MA2621L-TC-#	B-MA2621L-SS-#	
	22U (45U)	B-MA2622L-TC-#	B-MA2622L-SS-#	
	23U (45U)	B-MA2623L-TC-#	B-MA2623L-SS-#	
	24U (48U)	B-MA2624L-TC-#	B-MA2624L-SS-#	
	25U (50U)	B-MA2625L-TC-#	B-MA2625L-SS-#	

Specify Color: "2" = Black; "0" = Clear Zinc

Full-Height Split 23" EIA Mounting Angle Sets

- Use only on 26" wide frames
- 12 GA (0.105") steel construction
- Height must match frame height
- Sets include (4) EIA half-height mounting angles - ex. (2) 20U top & (2) 20U bottom for 40U set and hardware to mount to frame
- #10-32 tapped holes allow fast installation of equipment with screws only
- 0.281 clearance holes require clip nut hardware and screws
- 0.375 square holes require cage nut hardware and screws - ideal for servers
- Color: painted black or plated clear zinc

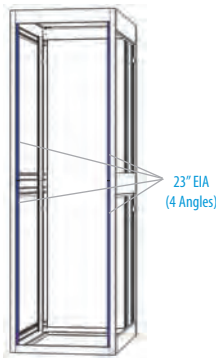

Top View		#10-32 Tapped Holes	0.281 Clear Holes	0.375" Square Holes
Frame Width/EIA	Fits Frame Height (U)	Tapped #10-32 (0.281 clearance side holes)	0.375 Square Hole (0.375 square side holes)	
L-shaped 26"W (23" EIA)	40U	B-MAS40L-TC-#	B-MAS40L-SS-#	
	42U	B-MAS42L-TC-#	B-MAS42L-SS-#	
	45U	B-MAS45L-TC-#	B-MAS45L-SS-#	
	48U	B-MAS48L-TC-#	B-MAS48L-SS-#	
	50U	B-MAS50L-TC-#	B-MAS50L-SS-#	

Specify Color: "2" = Black; "0" = Clear Zinc

Half-Height 23" EIA Mounting Angle Sets

- Use only on 26" wide frames
- 12 GA (0.105") steel construction
- Half-height sets for combo 19" & 23" racks
- Sets include (2) EIA Half-height Mounting Angles - ex. (2) 20U angles in 20U set - mount top or bottom on 40U frame and hardware to mount to frame
- #10-32 tapped holes allow fast installation of equipment with screws only
- 0.281 clearance holes require clip nut hardware and screws
- 0.375 square holes require cage nut hardware and screws - ideal for servers
- Color: Painted Black or Plated Clear Zinc

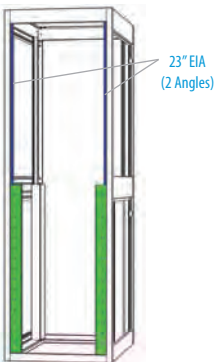

Top View		#10-32 Tapped Holes	0.281 Clear Holes	0.375" Square Holes
Frame Width/EIA Rack-mount	Height (U)/Fits Frame Height	Tapped #10-32 (0.281 clearance side holes)	0.375 Square Hole (0.375 square side holes)	
L-shaped 26"W (23" EIA)	20U (40U)	B-MA20L-TC-#	B-MA20L-SS-#	
	21U (42U)	B-MA21L-TC-#	B-MA21L-SS-#	
	22U (45U)	B-MA22L-TC-#	B-MA22L-SS-#	
	23U (45U)	B-MA23L-TC-#	B-MA23L-SS-#	
	24U (48U)	B-MA24L-TC-#	B-MA24L-SS-#	
	25U (50U)	B-MA25L-TC-#	B-MA25L-SS-#	

Specify Color: "2" = Black; "0" = Clear Zinc



Full-height angle set - 19" - 26" wide, 4-strut frames.



Mixed half-height angles shown at different depths - 26" wide, 4-strut frames.

hardware

Panel Screw Kits



- Decorative low profile truss head with phillips drive
- Nylon washers reduce vibration noise and prevent scratches to the face of your equipment
- 500 pack includes reusable jar



Part Number	Color	Description	Kit Quantity
S1B-1032-50	Black	10-32 x 5/8" w/Nylon Washer	50
S1B-1032-500	Black	10-32 x 5/8" w/Nylon Washer	500 (jar)
S1N-1032-50	Nickel	10-32 x 5/8" w/Nylon Washer	50

Clip Nut & Cage Nut Kits



- Clip nuts allow mounting of hardware on 0.281 clear holes
- Cage nuts allow mounting of hardware on 0.375 holes
- Clip nuts slide over rail - no tools required
- Cage nuts snap into 0.375 square hole
- Mounting Angle - Cage Nut Tool recommended to speed installation (CN-TOOL)



Part Number	Color	Description	Kit Quantity
HK-3-50	Nickel	10-32 Clip Nuts (for 0.281 holes)	50
CN12-1032-50	Nickel	10-32 Cage Nuts (for 0.375 holes)	50
CN-TOOL	Stainless	Cage Nut Installation Tool	1

Unistrut® Hardware Kit



- 1/4"-20 hardware allows additional equipment or accessories to be mounted to front-to-back internal Unistrut members
- 1/4"-20x3/4" serrated hex head bolts included in 1/4" kit (not shown in photo)

Part Number	Color	Description	Kit Quantity
UN-1420-10	Silver	1/4-20 Bolts & Unistrut® Nuts	10

Rack Unit Labels



- Adhesive-backed labels allow easy equipment alignment during installation
- Sold individually - 1 kit covers 1 mounting angle – order 4 to cover 4 mounting angles
- Magnetic strip allows alignment during installation and removal to another rack after complete

Part Number	Size	Description	Quantity
U-LBL-1	Up to 60U	Adhesive Rack Unit Label	1
MAG-50	50U	Magnetic Rack Unit Label	1

Multi-Bay Hardware Kit



- Bolts two frames together
- Special 1/4"-20x3/4" serrated head bolts and lock nuts prevent loosening

Part Number	Color	Description	Kit Quantity
B-MBK	Silver	1/4-20 Serrated Bolts & Nuts	6

above floor bases

Levelers



- Allows leveling of frame on uneven surfaces
- Isolation Leveler Kit includes (4) lock nuts
- Install directly into pre-threaded frame bottom
- 1 kit per (1) frame
- Isolation pad levelers shown at far left

Part Number	Description
LVL-4	Levelers - 1/2-13 Thread with Isolation Pads, Qty. 4
LVL-4	Levelers - 1/2-13 Thread with Steel Pad, Qty. 4

3" Riser Base



- Adds 3" to overall frame height
- 3" high skirt
- 14 GA (0.075") steel construction
- Base anchors directly to floor or sub-floor base
- Anchoring holes in base are 0.625" dia.
- Installs directly to bottom of frame(s)
- Must match frame width and depth

Frame Width	Fits Frame Depth	Part Number
22"W	30.88"	B-1B30-#
	36.13"	B-1B36-#
	39.63"	B-1B39-#
	44.88"	B-1B44-#
24"W	30.88"	B-1B2430-#
	36.13"	B-1B2436-#
	39.63"	B-1B2439-#
	44.88"	B-1B2444-#
26"W	30.88"	B-1B2630-#
	36.13"	B-1B2636-#
	39.63"	B-1B2639-#
	44.88"	B-1B2644-#

Specify Color: "1" = White; "2" = Black; "3" = Charcoal; "5" = Flint Grey; "6" = Royal Blue; "9" = Platinum (see Page 31 for finishes)

Leveler Bases



- Adds minimum 3.25" to overall Frame height
- 3" high skirt
- 14 GA (0.075") steel construction
- Allows frame leveling on uneven surfaces
- Kits includes (4) 1/2-13 steel levelers
- Anchoring holes in base are 0.625" dia.
- Install directly to bottom of frame
- One base supports (1) frame
- Must match frame width and depth

Frame Width	Fits Frame Depth	Part Number
22"W	30.88"	B-1B30L-#
	36.13"	B-1B36L-#
	39.63"	B-1B39L-#
	44.88"	B-1B44L-#
24"W	30.88"	B-1B2430L-#
	36.13"	B-1B2436L-#
	39.63"	B-1B2439L-#
	44.88"	B-1B2444L-#
26"W	30.88"	B-1B2630L-#
	36.13"	B-1B2636L-#
	39.63"	B-1B2639L-#
	44.88"	B-1B2644L-#

Specify Color: "1" = White; "2" = Black; "3" = Charcoal; "5" = Flint Grey; "6" = Royal Blue; "9" = Platinum (see Page 31 for finishes)

Caster & Leveler Bases



- Adds minimum of 4.85" to overall frame height
- 3" high skirt - 14 GA (0.075") steel
- Caster plates - 12 GA (0.105") steel
- Kits includes (4) 1/2-13 heavy-duty levelers - lower after rolled into position
- Kits includes (4) 3.5" dia. swivel non-locking casters - 400 lbs. ea.
- Install directly to bottom of frame
- One base supports (1) frame
- Must match frame width and depth

Frame Width	Fits Frame Depth	Part Number
22"W	30.88"	B-1B30CL-#
	36.13"	B-1B36CL-#
	39.63"	B-1B39CL-#
	44.88"	B-1B44CL-#
24"W	30.88"	B-1B2430CL-#
	36.13"	B-1B2436CL-#
	39.63"	B-1B2439CL-#
	44.88"	B-1B2444CL-#
26"W	30.88"	B-1B2630CL-#
	36.13"	B-1B2636CL-#
	39.63"	B-1B2639CL-#
	44.88"	B-1B2644CL-#

Specify Color: "1" = White; "2" = Black; "3" = Charcoal; "5" = Flint Grey; "6" = Royal Blue; "9" = Platinum (see Page 31 for finishes)

above-floor bases

5" Stand Cabling Bases



- Stand bases are designed to provide a solid structure to connect to the floor
- 11 GA (0.120") steel structure
- 16 GA (0.060") steel removable covers
- Base anchors (3/4"x1-1/4" slots) directly to floor allowing cables to pass bay to bay under frames - includes covers to conceal cables
- Designed to mate directly to frames
- Custom heights available upon request
- Must match frame width and depth for number of bays

Frame Width	Fits Frame Depth	# of Bays	Part Number
22.0"W	30.88"	1	B-1B30CS-5-#
		2	B-2B30CS-5-#
		3	B-3B30CS-5-#
	36.13"	1	B-1B36CS-5-#
		2	B-2B36CS-5-#
		3	B-3B36CS-5-#
	39.63"	1	B-1B39CS-5-#
		2	B-2B39CS-5-#
		3	B-3B39CS-5-#
	44.88"	1	B-1B44CS-5-#
		2	B-2B44CS-5-#
		3	B-3B44CS-5-#

Frame Width	Fits Frame Depth	# of Bays	Part Number
24.0"W	30.88"	1	B-1B2430CS-5-#
		2	B-2B2430CS-5-#
		3	B-3B2430CS-5-#
	36.13"	1	B-1B2436CS-5-#
		2	B-2B2436CS-5-#
		3	B-3B2436CS-5-#
	39.63"	1	B-1B2439CS-5-#
		2	B-2B2439CS-5-#
		3	B-3B2439CS-5-#
	44.88"	1	B-1B2444CS-5-#
		2	B-2B2444CS-5-#
		3	B-3B2444CS-5-#

Frame Width	Fits Frame Depth	# of Bays	Part Number
26.0"W	30.88"	1	B-1B2630CS-5-#
		2	B-2B2630CS-5-#
		3	B-3B2630CS-5-#
	36.13"	1	B-1B2636CS-5-#
		2	B-2B2636CS-5-#
		3	B-3B2636CS-5-#
	39.63"	1	B-1B2639CS-5-#
		2	B-2B2639CS-5-#
		3	B-3B2639CS-5-#
	44.88"	1	B-1B2644CS-5-#
		2	B-2B2644CS-5-#
		3	B-3B2644CS-5-#

Specify Color: "1" = White; "2" = Black; "3" = Charcoal; "5" = Flint Grey; "6" = Royal Blue; "9" = Platinum (see Page 31 for finishes)

subfloor bases

Subfloor Bases



- Subfloor bases are designed to provide a solid structure to connect to the concrete subfloor below a raised floor
- 12 GA (0.105") steel & 1/8" thick tubing construction
- Designed to mate directly to frames or 3" high riser bases
- Available in standard heights of 12", 18" & 24" - custom heights available
- Meets UBC Zone 4 seismic requirements
- 3/4"x1-1/4" slotted anchoring holes
- Color: Black

Height	Fits Frame Depth	# of Bays	12" Base Height	18" Base Height	24" Base Height
22"W	30.88"	1	B-1B30SF-12-#	B-1B30SF-18-#	B-1B30SF-24-#
		2	B-2B30SF-12-#	B-2B30SF-18-#	B-2B30SF-24-#
		3	B-3B30SF-12-#	B-3B30SF-18-#	B-3B30SF-24-#
	36.13"	1	B-1B36SF-12-#	B-1B36SF-18-#	B-1B36SF-24-#
		2	B-2B36SF-12-#	B-2B36SF-18-#	B-2B36SF-24-#
		3	B-3B36SF-12-#	B-3B36SF-18-#	B-3B36SF-24-#
	39.63"	1	B-1B39SF-12-#	B-1B39SF-18-#	B-1B39SF-24-#
		2	B-2B39SF-12-#	B-2B39SF-18-#	B-2B39SF-24-#
		3	B-3B39SF-12-#	B-3B39SF-18-#	B-3B39SF-24-#
	44.88"	1	B-1B44SF-12-#	B-1B44SF-18-#	B-1B44SF-24-#
		2	B-2B44SF-12-#	B-2B44SF-18-#	B-2B44SF-24-#
		3	B-3B44SF-12-#	B-3B44SF-18-#	B-3B44SF-24-#

Height	Fits Frame Depth	# of Bays	12" Base Height	18" Base Height	24" Base Height
24"W	30.88"	1	B-1B2430SF-12-#	B-1B2430SF-18-#	B-1B2430SF-24-#
		2	B-2B2430SF-12-#	B-2B2430SF-18-#	B-2B2430SF-24-#
		3	B-3B2430SF-12-#	B-3B2430SF-18-#	B-3B2430SF-24-#
	36.13"	1	B-1B2436SF-12-#	B-1B2436SF-18-#	B-1B2436SF-24-#
		2	B-2B2436SF-12-#	B-2B2436SF-18-#	B-2B2436SF-24-#
		3	B-3B2436SF-12-#	B-3B2436SF-18-#	B-3B2436SF-24-#
	39.63"	1	B-1B2439SF-12-#	B-1B2439SF-18-#	B-1B2439SF-24-#
		2	B-2B2439SF-12-#	B-2B2439SF-18-#	B-2B2439SF-24-#
		3	B-3B2439SF-12-#	B-3B2439SF-18-#	B-3B2439SF-24-#
	44.88"	1	B-1B2444SF-12-#	B-1B2444SF-18-#	B-1B2444SF-24-#
		2	B-2B2444SF-12-#	B-2B2444SF-18-#	B-2B2444SF-24-#
		3	B-3B2444SF-12-#	B-3B2444SF-18-#	B-3B2444SF-24-#

Height	Fits Frame Depth	# of Bays	12" Base Height	18" Base Height	24" Base Height
26"W	30.88"	1	B-1B2630SF-12-#	B-1B2630SF-18-#	B-1B2630SF-24-#
		2	B-2B2630SF-12-#	B-2B2630SF-18-#	B-2B2630SF-24-#
		3	B-3B2630SF-12-#	B-3B2630SF-18-#	B-3B2630SF-24-#
	36.13"	1	B-1B2636SF-12-#	B-1B2636SF-18-#	B-1B2636SF-24-#
		2	B-2B2636SF-12-#	B-2B2636SF-18-#	B-2B2636SF-24-#
		3	B-3B2636SF-12-#	B-3B2636SF-18-#	B-3B2636SF-24-#
	39.63"	1	B-1B2639SF-12-#	B-1B2639SF-18-#	B-1B2639SF-24-#
		2	B-2B2639SF-12-#	B-2B2639SF-18-#	B-2B2639SF-24-#
		3	B-3B2639SF-12-#	B-3B2639SF-18-#	B-3B2639SF-24-#
	44.88"	1	B-1B2644SF-12-#	B-1B2644SF-18-#	B-1B2644SF-24-#
		2	B-2B2644SF-12-#	B-2B2644SF-18-#	B-2B2644SF-24-#
		3	B-3B2644SF-12-#	B-3B2644SF-18-#	B-3B2644SF-24-#

Specify Color: "1" = White; "2" = Black; "3" = Charcoal; "5" = Flint Grey; "6" = Royal Blue; "9" = Platinum (see Page 31 for finishes)

Shim Kit



- 4"x4" steel plates in varying thicknesses - includes (10)ea.:
- 18 GA (0.048"), 16 GA (0.060"), 14 GA (0.075"), & 12 GA (0.105")
- Designed for use with cabling stands & subfloor bases, shim plates are utilized to compensate for uneven flooring
- Plates are painted black
- Tab allows grip area for easy installation

Part Number	Color	Description
SHM-4	Black	4"x4" Shim Kit - Varying Thicknesses (2.8" total)

subfloor bases

doors - full-width



Surface Door Handle



Surface-Mount Doors - Full Width

Overall Frame Width	Frame Height	Solid	Vented Top & Bottom	Full Mesh	Plexiglas with Vents
22.0"	40U	B-DL40S-S-#	B-DL40V-S-#	B-DL40M-S-#	B-DL40PV-S-#
	42U	B-DL42S-S-#	B-DL42V-S-#	B-DL42M-S-#	B-DL42PV-S-#
	45U	B-DL45S-S-#	B-DL45V-S-#	B-DL45M-S-#	B-DL45PV-S-#
	48U	B-DL48S-S-#	B-DL48V-S-#	B-DL48M-S-#	B-DL48PV-S-#
	50U	B-DL50S-S-#	B-DL50V-S-#	B-DL50M-S-#	B-DL50PV-S-#
24.0"	40U	B-DL2440S-S-#	B-DL2440V-S-#	B-DL2440M-S-#	B-DL2440PV-S-#
	42U	B-DL2442S-S-#	B-DL2442V-S-#	B-DL2442M-S-#	B-DL2442PV-S-#
	45U	B-DL2445S-S-#	B-DL2445V-S-#	B-DL2445M-S-#	B-DL2445PV-S-#
	48U	B-DL2448S-S-#	B-DL2448V-S-#	B-DL2448M-S-#	B-DL2448PV-S-#
	50U	B-DL2450S-S-#	B-DL2450V-S-#	B-DL2450M-S-#	B-DL2450PV-S-#
26.0"	40U	B-DL2640S-S-#	B-DL2640V-S-#	B-DL2640M-S-#	B-DL2640PV-S-#
	42U	B-DL2642S-S-#	B-DL2642V-S-#	B-DL2642M-S-#	B-DL2642PV-S-#
	45U	B-DL2645S-S-#	B-DL2645V-S-#	B-DL2645M-S-#	B-DL2645PV-S-#
	48U	B-DL2648S-S-#	B-DL2648V-S-#	B-DL2648M-S-#	B-DL2648PV-S-#
	50U	B-DL2650S-S-#	B-DL2650V-S-#	B-DL2650M-S-#	B-DL2650PV-S-#

Specify Color: "1" = White; "2" = Black; "3" = Charcoal; "5" = Flint Grey; "6" = Royal Blue; "9" = Platinum (see Page 31 for finishes)

Specifications

- Front or rear mounting
- Adds 1" to overall depth of frame (excluding handle & hinges)
- 16 GA (0.060") steel construction
- Includes swing handle with key lock
- 180 degree, self-contained lift-off hinges
- All part numbers shown are for left-hinged doors. For right-hinged doors, specify "B-DR" in part number replacing "B-DL". Doors are not field-reversible.
- Frames are only pre-drilled for surface-mount doors at time of order. Future retrofit requires field drilling of frame. Contact your application specialist for drill template ordering information.

Application Notes

Solid

- Utilize to conceal interior contents and prevent air from entering or exiting
- Typically used in a bottom-to-top airflow pattern with fans

Vented Top & Bottom

- Utilize to secure interior contents and provide minimal airflow
- 4 punched sections - 6"W x 8"H - 0.25" dia. on 0.312 staggered centers

Full Mesh

- Utilize to secure interior contents & provide maximum air to enter/exit
- Welded-in mesh - 0.25" dia. on 0.312 staggered centers
- Typically used in a front-to-back airflow pattern with full mesh front & rear

Plexiglas with Vents

- Utilize for viewing interior contents & allowing airflow to enter
- Vent pattern - 0.25" dia. on 0.312 staggered centers

dual rear doors



Rear Door Handle



Surface-Mount Dual Rear Doors

Overall Frame Width	Frame Height	Solid	Full Mesh
22.0"	40U	B-DD40S-S-#	B-DD40M-S-#
	42U	B-DD42S-S-#	B-DD42M-S-#
	45U	B-DD45S-S-#	B-DD45M-S-#
	48U	B-DD48S-S-#	B-DD48M-S-#
	50U	B-DD50S-S-#	B-DD50M-S-#
Overall Frame Width	Frame Height	Solid	Full Mesh
24.0"	40U	B-DD2440S-S-#	B-DD2440M-S-#
	42U	B-DD2442S-S-#	B-DD2442M-S-#
	45U	B-DD2445S-S-#	B-DD2445M-S-#
	48U	B-DD2448S-S-#	B-DD2448M-S-#
	50U	B-DD2450S-S-#	B-DD2450M-S-#
Overall Frame Width	Frame Height	Solid	Full Mesh
26.0"	40U	B-DD2640S-S-#	B-DD2640M-S-#
	42U	B-DD2642S-S-#	B-DD2642M-S-#
	45U	B-DD2645S-S-#	B-DD2645M-S-#
	48U	B-DD2648S-S-#	B-DD2648M-S-#
	50U	B-DD2650S-S-#	B-DD2650M-S-#

Specify Color: "1" = White; "2" = Black; "3" = Charcoal; "5" = Flint Grey; "6" = Royal Blue; "9" = Platinum (see Page 31 for finishes)

Specifications

- Split design minimizes aisle blockage
- Rear mounting only
- Adds 1" to overall depth of frame (excluding handle & hinges)
- 16 GA (0.060") steel construction
- Includes swing handle with 3-point latch and key lock
- 180 degree, self-contained lift-off hinges
- Frames are only pre-drilled for surface-mount doors at time of order. Future retrofit requires field drilling of frame. Contact your application specialist for drill template ordering information.

Application Notes

Solid

- Utilize to conceal interior contents and prevent air from entering or exiting
- Typically used in a bottom-to-top airflow pattern with fans

Full Mesh

- Utilize to secure interior contents & provide maximum air to exit
- Punched-in mesh - 0.25" dia. on 0.312 staggered centers
- Typically used in a front-to-back airflow pattern with full mesh or no door on front of frame

side panels

Side Panels & Inter-Bay Divider Panels



Non-Locking



Locking



Side Panel Detail

- Each part number includes 2 half-height side panels (covers one side)
- 18 gauge steel construction
- Side panels are solid (no vents)
- Locking or non-locking available
- Smaller panels provide ergonomic handling
- Side panel must match height and depth of frame
- Inter-bay divider panels are flat steel panels bolted on to frame - designed for use between 2 ganged cabinets

Frame Width	Frame Height	Frame Depth	Locking	Non-Locking	Inter-Bay Divider
22.0"W & 24.0"W	40U	30.88"	B-S4030S-L-#	B-S4030S-N-#	B-DP4030S-#
		36.13"	B-S4036S-L-#	B-S4036S-N-#	B-DP4036S-#
		39.63"	B-S4039S-L-#	B-S4039S-N-#	B-DP4039S-#
		44.88"	B-S4044S-L-#	B-S4044S-N-#	B-DP4044S-#
	42U	30.88"	B-S4230S-L-#	B-S4230S-N-#	B-DP4230S-#
		36.13"	B-S4236S-L-#	B-S4236S-N-#	B-DP4236S-#
		39.63"	B-S4239S-L-#	B-S4239S-N-#	B-DP4239S-#
		44.88"	B-S4244S-L-#	B-S4244S-N-#	B-DP4244S-#
	45U	30.88"	B-S4530S-L-#	B-S4530S-N-#	B-DP4530S-#
		36.13"	B-S4536S-L-#	B-S4536S-N-#	B-DP4536S-#
		39.63"	B-S4539S-L-#	B-S4539S-N-#	B-DP4539S-#
		44.88"	B-S4544S-L-#	B-S4544S-N-#	B-DP4544S-#
	48U	30.88"	B-S4830S-L-#	B-S4830S-N-#	B-DP4830S-#
		36.13"	B-S4836S-L-#	B-S4836S-N-#	B-DP4836S-#
		39.63"	B-S4839S-L-#	B-S4839S-N-#	B-DP4839S-#
		44.88"	B-S4844S-L-#	B-S4844S-N-#	B-DP4844S-#
	50U	30.88"	B-S5030S-L-#	B-S5030S-N-#	B-DP5030S-#
		36.13"	B-S5036S-L-#	B-S5036S-N-#	B-DP5036S-#
39.63"		B-S5039S-L-#	B-S5039S-N-#	B-DP5039S-#	
44.88"		B-S5044S-L-#	B-S5044S-N-#	B-DP5044S-#	

Frame Width	Frame Height	Frame Depth	Locking	Non-Locking	Inter-Bay Divider
26.0"W	40U	30.88"	B-S4S4030S-L-#	B-S4S4030S-N-#	B-DP4S4030S-#
		36.13"	B-S4S4036S-L-#	B-S4S4036S-N-#	B-DP4S4036S-#
		39.63"	B-S4S4039S-L-#	B-S4S4039S-N-#	B-DP4S4039S-#
		44.88"	B-S4S4044S-L-#	B-S4S4044S-N-#	B-DP4S4044S-#
	42U	30.88"	B-S4S4230S-L-#	B-S4S4230S-N-#	B-DP4S4230S-#
		36.13"	B-S4S4236S-L-#	B-S4S4236S-N-#	B-DP4S4236S-#
		39.63"	B-S4S4239S-L-#	B-S4S4239S-N-#	B-DP4S4239S-#
		44.88"	B-S4S4244S-L-#	B-S4S4244S-N-#	B-DP4S4244S-#
	45U	30.88"	B-S4S4530S-L-#	B-S4S4530S-N-#	B-DP4S4530S-#
		36.13"	B-S4S4536S-L-#	B-S4S4536S-N-#	B-DP4S4536S-#
		39.63"	B-S4S4539S-L-#	B-S4S4539S-N-#	B-DP4S4539S-#
		44.88"	B-S4S4544S-L-#	B-S4S4544S-N-#	B-DP4S4544S-#
	48U	30.88"	B-S4S4830S-L-#	B-S4S4830S-N-#	B-DP4S4830S-#
		36.13"	B-S4S4836S-L-#	B-S4S4836S-N-#	B-DP4S4836S-#
		39.63"	B-S4S4839S-L-#	B-S4S4839S-N-#	B-DP4S4839S-#
		44.88"	B-S4S4844S-L-#	B-S4S4844S-N-#	B-DP4S4844S-#
	50U	30.88"	B-S4S5030S-L-#	B-S4S5030S-N-#	B-DP4S5030S-#
		36.13"	B-S4S5036S-L-#	B-S4S5036S-N-#	B-DP4S5036S-#
		39.63"	B-S4S5039S-L-#	B-S4S5039S-N-#	B-DP4S5039S-#
		44.88"	B-S4S5044S-L-#	B-S4S5044S-N-#	B-DP4S5044S-#

Specify Color: "1" = White; "2" = Black; "3" = Charcoal; "5" = Flint Grey; "6" = Royal Blue; "9" = Platinum (see Page 31 for finishes)

top panels

top panels

Full Depth Top Panels



- Use to cover entire top
- 16 GA (0.060") steel
- Vented: 0.25" dia. on 0.312" centers (58% Open area)
- Fans: includes (2) 235 CFM 6" diameter fans or (1) 550 CFM, 10" diameter fans & finger guards
- Cords: 120V=daisy chain to single 2-prong plug NEMA 1-15; wire leads for connection

Fame Width	Frame Depth	Solid	Vented	120V - Dual 6" Fan (235 CFM ea.)	120V 10" Fan (550 CFM ea.)
				B-T30F26-1-#	B-T30F10-1-#
22.0"W	30.88"	B-T30S-#	B-T30V-#	B-T30F26-1-#	B-T30F10-1-#
	36.13"	B-T36S-#	B-T36V-#	B-T36F26-1-#	B-T36F10-1-#
	39.63"	B-T39S-#	B-T39V-#	B-T39F26-1-#	B-T39F10-1-#
	44.88"	B-T44S-#	B-T44V-#	B-T44F26-1-#	B-T44F10-1-#
24.0"W	30.88"	B-T2430S-#	B-T2430V-#	B-T2430F26-1-#	B-T2430F10-1-#
	36.13"	B-T2436S-#	B-T2436V-#	B-T2436F26-1-#	B-T2436F10-1-#
	39.63"	B-T2439S-#	B-T2439V-#	B-T2439F26-1-#	B-T2439F10-1-#
	44.88"	B-T2444S-#	B-T2444V-#	B-T2444F26-1-#	B-T2444F10-1-#
26.0"W	30.88"	B-T2630S-#	B-T2630V-#	B-T2630F26-1-#	B-T2630F10-1-#
	36.13"	B-T2636S-#	B-T2636V-#	B-T2636F26-1-#	B-T2636F10-1-#
	39.63"	B-T2639S-#	B-T2639V-#	B-T2639F26-1-#	B-T2639F10-1-#
	44.88"	B-T2644S-#	B-T2644V-#	B-T2644F26-1-#	B-T2644F10-1-#

Specify Color: "1" = White; "2" = Black; "3" = Charcoal; "5" = Flint Grey; "6" = Royal Blue; "9" = Platinum (see Page 31 for finishes)

Shorter Depth Top Panels - for 12.25"

Opening, H-Panel, or Cable Ladder



- Provides 12.25" D opening for cabling, optional H-panel, or optional cable ladder
- Other specs same as full depth
- 16 GA (0.060") steel
- Fans: includes (2) 235 CFM 6" diameter fans or (1) 550 CFM, 10" diameter fans & finger guards

Fame Width	Frame Depth	Solid	Vented	120V - Dual 6" Fan (235 CFM ea.)	120V 10" Fan (550 CFM ea.)
				B-T30F26S-1-#	B-T30F10S-1-#
22.0"W	30.88"	B-T30SS-#	B-T30VS-#	B-T30F26S-1-#	B-T30F10S-1-#
	36.13"	B-T36SS-#	B-T36VS-#	B-T36F26S-1-#	B-T36F10S-1-#
	39.63"	B-T39SS-#	B-T39VS-#	B-T39F26S-1-#	B-T39F10S-1-#
	44.88"	B-T44SS-#	B-T44VS-#	B-T44F26S-1-#	B-T44F10S-1-#
24.0"W	30.88"	B-T2430SS-#	B-T2430VS-#	B-T2430F26S-1-#	B-T2430F10S-1-#
	36.13"	B-T2436SS-#	B-T2436VS-#	B-T2436F26S-1-#	B-T2436F10S-1-#
	39.63"	B-T2439SS-#	B-T2439VS-#	B-T2439F26S-1-#	B-T2439F10S-1-#
	44.88"	B-T2444SS-#	B-T2444VS-#	B-T2444F26S-1-#	B-T2444F10S-1-#
26.0"W	30.88"	B-T2630SS-#	B-T2630VS-#	B-T2630F26S-1-#	B-T2630F10S-1-#
	36.13"	B-T2636SS-#	B-T2636VS-#	B-T2636F26S-1-#	B-T2636F10S-1-#
	39.63"	B-T2639SS-#	B-T2639VS-#	B-T2639F26S-1-#	B-T2639F10S-1-#
	44.88"	B-T2644SS-#	B-T2644VS-#	B-T2644F26S-1-#	B-T2644F10S-1-#

Specify Color: "1" = White; "2" = Black; "3" = Charcoal; "5" = Flint Grey; "6" = Royal Blue; "9" = Platinum (see Page 31 for finishes)

top panels

12.25" Top Panels & Cabling H-Panel

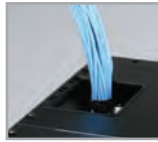

- H-Panel allows panel installation and removal without removing cables
- Eliminates cable fishing through holes
- Solid & vented panels allow 2-piece tops for easy removal
- Use with shorter depth top panels listed above to cover entire top
- 16 GA (0.060") steel

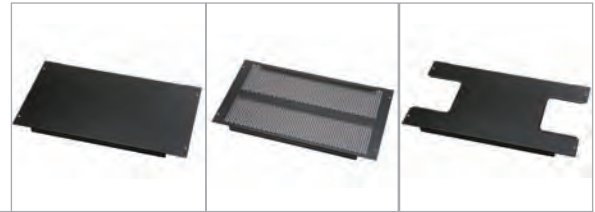

Fits Overall Frame Width	Solid	Vented	H-Panel
22.0"	B-T12S-#	B-T12V-#	B-T12H-#
Fits Overall Frame Width	Solid	Vented	H-Panel
24.0"	B-T2412S-#	B-T2412V-#	B-T2412H-#
Fits Overall Frame Width	Solid	Vented	H-Panel
26.0"	B-T2612S-#	B-T2612V-#	B-T2612H-#

Specify Color: "1" = White; "2" = Black; "3" = Charcoal; "5" = Flint Grey; "6" = Royal Blue; "9" = Platinum (see Page 31 for finishes)

12.25" Wide Cable Ladder



- Provides integrated overhead cable routing on top of the enclosure frame
- Fits 22" wide frames only
- Use stand-alone or with shorter depth top panels listed above to cover entire top

Fits Frame Width	Description	Part Number
22.0"	12" Deep Integrated Cable Tray Ladder	B-CT-12-#
Fits Frame Width	Description	Part Number
24.0"	12" Deep Integrated Cable Tray Ladder	B-CT24-12-#
Fits Frame Width	Description	Part Number
26.0"	12" Deep Integrated Cable Tray Ladder	B-CT26-12-#

Specify Color: "1" = White; "2" = Black; "3" = Charcoal; "5" = Flint Grey; "6" = Royal Blue; "9" = Platinum (see Page 31 for finishes)

H-Panel Brush Kit

- Brush Kit covers the 2 openings in a cabling H-Panel
- Brush kit allows cables to drop while helping to minimize the airflow passing through the opening.

Description	Part Number
Brush Kit for 12.25" H-Panel	B-TBK

filler panels

19" EIA Filler Panels - Aluminum

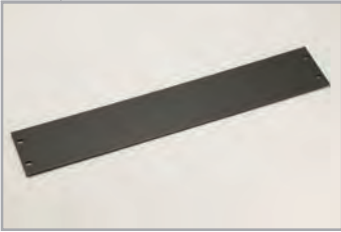

aluminum	Height	Solid
	1U	PA-1-#
	2U	PA-2-#
	3U	PA-3-#
	4U	PA-4-#
	5U	PA-5-#
	6U	PA-6-#

- Panels provide finished look while functionally blocking or directing airflow
- Material: 0.125" thick aluminum
- Aluminum allows easy field modification for cable ports, or other connection devices
- Includes #10-32 mounting hardware

Specify Color: "1" = White; "2" = Black; "3" = Charcoal; "5" = Flint Grey; "6" = Royal Blue; "9" = Platinum (see Page 31 for finishes)

19" EIA Filler Panels - Steel - Flat with Flanges

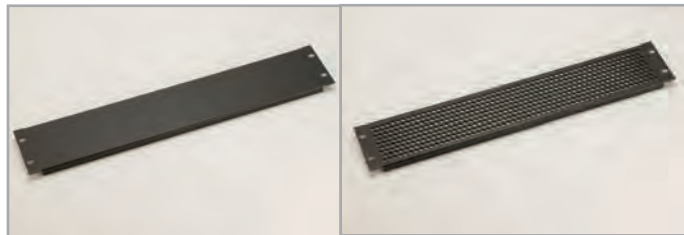

- Panels provide finished look while functionally blocking or directing airflow
- Formed flanges provide structural rigidity to panel
- Material: 16 GA (0.060") steel
- Includes #10-32 mounting hardware

steel flanged	Height	Solid	Vented
	1U	PSF-1-#	PSFV-1-#
	2U	PSF-2-#	PSFV-2-#
	3U	PSF-3-#	PSFV-3-#
	4U	PSF-4-#	PSFV-4-#
	5U	PSF-5-#	PSFV-5-#
	6U	PSF-6-#	PSFV-6-#

Specify Color: "1" = White; "2" = Black; "3" = Charcoal; "5" = Flint Grey; "6" = Royal Blue; "9" = Platinum (see Page 31 for finishes)

19" EIA Filler Panels - Fan - Flat with Flanges



fan	Height	Part Number
	3U	PSFF-3-#

Specify Color: "1" = White; "2" = Black; "3" = Charcoal; "5" = Flint Grey; "6" = Royal Blue; "9" = Platinum (see Page 31 for finishes)

- Low noise fans (37dB)
- Includes (2) 120V, 4" fans at 110 CFM ea. with finger guards and connect to a single power cord with a 2-prong plug (NEMA 1-15P)
- Ships completely assembled
- Panels provide finished look while functionally directing airflow
- Material: 16 GA (0.060") steel
- Includes #10-32 mounting hardware

cable management

Vertical Lacing Bars - Steel - 1" Wide



- 1" Wide for cable lacing
- Material: 12 GA (0.105") steel
- Slots allow velcro or other cable straps to neatly organize cable bundles
- Includes hardware to mount to front-to-back members
- Color: Black

Fits Frame Height	1" Wide with Slots
40U	LBV1S-40-2
42U	LBV1S-42-2
45U	LBV1S-45-2
48U	LBV1S-48-2
50U	LBV1S-50-2

Vertical Lacing Bars - Steel - 3.5" Wide



- 3.5" wide (no straps)
- Material: 14 GA (0.075") steel (2") & 12 GA (0.105") steel (3.5")
- Slots allow velcro or other cable straps to neatly organize cable bundles
- Includes hardware to mount to front-to-back members
- Color: Black

Fits Frame Height	3.5" Wide
40U	LBV3-40-2
42U	LBV3-42-2
45U	LBV3-45-2
48U	LBV3-48-2
50U	LBV3-50-2

Vertical Wire Trellis - 6"



- Provides vertical lacing of large cable bundles
- Material: 0.188" Wire Diameter
- Includes hardware to mount anywhere along front-to-back members
- Color: Black

Fits Frame Height	Part Number
40U	VWT-40-2
42U	VWT-42-2
45U	VWT-45-2
48U	VWT-48-2
50U	VWT-50-2

Vertical PDU Lacing Bar - Toolless PDU Button Mounting



- Open lacing slot design allows cable straps to mount from front side – no fishing thru slots
- Allows mounting of toolless button-mounted power
- Bar Mounts to Front to back Unistrut® frame members
- Material: 16 GA (0.060") steel
- Dimensions: Double-wide: 4.6" Wide x Height (table); Single-wide: 2.4" Wide x Height (table)
- Keyslot spacing: 6.125" vertically & 2.2" wide on center
- Includes hardware (3 Unistrut® Nuts & (3) 1/4-20 screws) to mount to front-to-back frame members
- Color: Black

Fits Frame Height	Single Wide - 2.4"	Double Wide - 4.6"
40U	LPMV2-40-2	LPMV4-40-2
42U	LPMV2-42-2	LPMV4-42-2
45U	LPMV2-45-2	LPMV4-45-2
48U	LPMV2-48-2	LPMV4-48-2
50U	LPMV2-50-2	LPMV4-50-2

cable management

Horizontal Lacing Bars

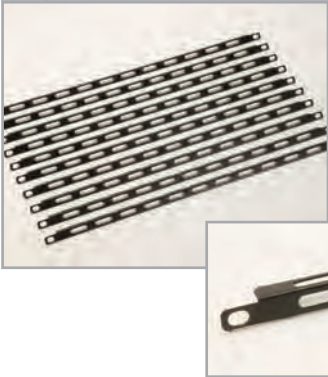

- Ship in packs of 10
- Material: 16 GA (0.060") steel
- Slots allow velcro or other cable straps to neatly organize cable bundles
- Includes #10-32 hardware to mount to EIA mounting angles
- Color: Black

Rack-mount Compatible	Kit Qty.	Part Number
19"	10	LBT-19-2

Lacing Rods

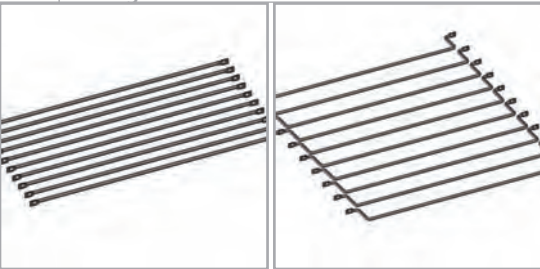

- Provides strain relief for cabling at face of equipment to ensure connectivity
- Available in straight or 2" off-set to accommodate varying equipment depths
- Mount to 19" EIA mounting angles
- Ship in packs of 10
- Color: Black

Rack-mount Compatible	Style	Kit Qty.	Part Number
19"	Straight	10	LR-19-2
19"	2" Offset	10	LR2-19-2

Horizontal Cable Managers



- 1U or 2U versions available
- Dimensions: 1Ux19" Wx3.25" D; 2Ux19" x3.25" D
- Material: 14 GA (0.075") steel
- Neatly organizes cables horizontally across rack space
- Includes #10-32 hardware to mount to EIA mounting angles
- Color: Black

Height	Rack-mount Compatible	Part Number
1U	19"	HC1-19-2
2U	19"	HC2-19-2

Hook & Loop Cable Ties



- Straps are 8" long
- Straps have hole for screw mounting to affix to structure (screws not included)
- Ship in packs of 10
- Color: Black

Description	Part Number
8" Velcro Cable Ties, Pack of 10	VT-10

shelves

Cantilevered Shelves - Solid

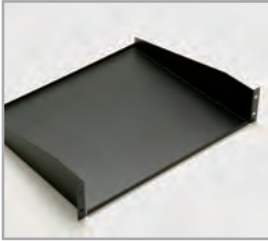

- Ideal for small, light non-rack-mount devices
- 2-post mounted
- 16 GA (0.060") steel
- Includes rack-mount hardware - (4) #10-32 screws and (4) cage nuts
- Black

Height x Depth	Weight Capacity	Part Number
1U x 12"	50 lbs.	CS1-2
2U x 15"	50 lbs.	CS2-2
3U x 15"	100 lbs.	CS3-2

Cantilevered Shelves - Vented

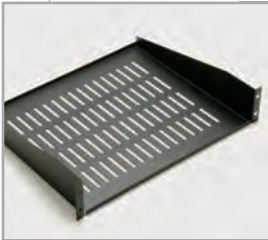

- Ideal for small, light non-rack-mount devices
- Vented for improved airflow and/or strapping down equipment
- 2-post mounted
- 16 GA (0.060") steel
- Includes rack-mount hardware - (4) #10-32 screws and (4) cage nuts
- Black

Height x Depth	Weight Capacity	Part Number
1U x 12"	50 lbs.	CSV1-2
2U x 15"	50 lbs.	CSV2-2
3U x 15"	100 lbs.	CSV3-2

Fixed-Shelf - 4-point Rack-Mount

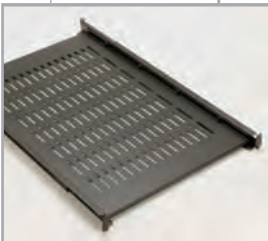

- Ideal for heavier non-rack-mount devices
- Vented for improved airflow and/or strapping down equipment
- Includes adjustable mounting ears
- Includes rack-mount hardware (8) #10-32 screws and (8) cage nuts
- 14 GA (0.075") steel
- Black

Height x Depth	Weight Capacity	Required Mounting Angle Spacing	Part Number
1U x 22"	200 lbs.	22" - 29"	FS1V-1922-2
1U x 24"	200 lbs.	20" - 30"	FS1V-1924-2
1U x 26"	200 lbs.	26" - 33"	FS1V-1926-2

Sliding Shelves - 4-point Rack-Mount



- Ideal for heavier non-rack-mount devices
- Vented for improved airflow and/or strapping down equipment
- Includes adjustable mounting ears and slides
- Includes rack-mount hardware (8) #10-32 screws & (8) cage nuts
- 14 GA (0.075") steel
- Black

Height x Depth	Weight Capacity	Required Mounting Angle Spacing	Part Number
1.97" x 24"	75 lbs.	24" - 30"	SS2V-1924-2
2U x 24"	150 lbs.	24" - 30"	SS1V-1924-2

Chassis Support Angles



- Only compatible with combo/offset mounting angles
- 1.75"H x 3"W – each angle
- Provide added support for heavy 2-post mounted equipment
- Includes 2 support angles
- Includes rack-mount hardware (4) #10-32 screws and (4) clip nuts
- 16GA (0.060") or 11 GA (0.120") steel
- Zinc plated

Depth	Weight Capacity	Required Mounting Angle Spacing	Part Number
18"	100 lbs.	18.1" - 22.0"	CA-LD-18
22"	100 lbs.	22.1" - 26.0"	CA-LD-22
26"	100 lbs.	26.1" - 30.0"	CA-LD-26
18"	200 lbs.	18.1" - 22.0"	CA-18
22"	200 lbs.	22.1" - 26.0"	CA-22
26"	200 lbs.	26.1" - 30.0"	CA-26

grounding & isolation

Copper Bus Bars - Vertical



- Isolated or non-isolated versions
- Holes are tapped #10-32 spaced on 2U (3.5" centers)
- Material: 1" x 0.25" thick copper bar
- Isolated styles include insulating spacers & bushings to provide electrical isolation
- Includes Unistrut® mounting hardware
- Includes holes for attaching 1/4" double-hole lugs
- CBI-25 & CBB-25 are 25U high with mounting provisions on all frame heights

	Isolated	Non-isolated	Fits Frame Height
	CBI-25	CBB-25	40-50U (partial)
	CBI-40	CBB-40	40U
	CBI-42	CBB-42	42U
	CBI-45	CBB-45	45U
	CBI-48	CBB-48	48U
	CBI-50	CBB-50	50U

Copper Bus Bars - Horizontal



- Isolated or non-isolated versions
- Holes are tapped #10-32 spaced on 2" centers
- Material: 1" x 0.25" thick copper bar
- Isolated styles include insulating spacers & bushings to provide electrical isolation
- Includes #10-32 hardware to mount to EIA mounting angles
- Includes holes for attaching 1/4" double-hole lugs

	Isolated	Non-isolated	Rack-mount Compatible
	CBIH-19	CBBH-19	19"

Grounding Straps



- #6 AWG green cotton jacketed copper
- Double lug terminals for 1/4" hardware at each end of strap
- Other sizes available upon request
- Includes (1) strap & hardware for both terminals - (4) 1/4" nuts, (4) 1/4" bolts, (4) lockwashers & (4) flat washers

Part Number	Description	Length
GRD-G-DL-6	#6 Cotton Jacketed w/double lugs	6"
GRD-G-DL-8	#6 Cotton Jacketed w/double lugs	8"
GRD-G-DL-10	#6 Cotton Jacketed w/double lugs	10"
GRD-G-DL-12	#6 Cotton Jacketed w/double lugs	12"
GRD-G-DL-14	#6 Cotton Jacketed w/double lugs	14"
GRD-G-DL-16	#6 Cotton Jacketed w/double lugs	16"
GRD-G-DL-18	#6 Cotton Jacketed w/double lugs	18"

Isolation Pads & Bushings



- Isolation pads are 3/16" thick insulating material - mount between frame and floor
- Pads are 3"W x 22", 24" and 26" long
- 2 pads per kit
- Holes in isolation pads align with anchoring holes in frame bottom
- Bushings are used to provide isolation of frame from anchoring hardware
- 4 bushings per kit

Part Number	Description
ISO-22	Isolation Pads (2) for 22"W Frames
ISO-24	Isolation Pads (2) for 24"W Frames
ISO-26	Isolation Pads (2) for 26"W Frames
ISO-B-38	Isolation Bushings (4) for 3/8" Hardware
ISO-B-50	Isolation Bushings (4) for 1/2" Hardware

Stand-Off Insulators & Unistrut® Insulator Kits



- Stand-offs insulate racks from overhead ladder and threaded rod
- Unistrut® Insulator Kits mount directly to the top of the frame and include: (1) strut, (2) 5/8" thread insulators (1 insulator for 22", 24" & 26"W) and all hardware to mount strut and insulators
- Select Unistrut® to match frame depth or width
- Front to back struts not compatible with top panels (use 22", 24" & 26"W side to side struts with tops)

Part Number	Description
C-ISO-63	Isolators for 5/8" Threaded Rod, Qty. 4
B-STK63-30-#	Unistrut Insulator Kit for 30"D Frame
B-STK63-36-#	Unistrut Insulator Kit for 36"D Frame
B-STK63-39-#	Unistrut Insulator Kit for 39"D Frame
B-STK63-44-#	Unistrut Insulator Kit for 44"D Frame
B-STK63-22-#	Unistrut Insulator Kit - 22"W
B-STK63-24-#	Unistrut Insulator Kit - 24"W
B-STK63-26-#	Unistrut Insulator Kit - 26"W
UN2-5811	5/8"-11 Unistrut Nut, Qty. 1

• Note: For Unistrut® Kits without Insulators eliminate the "63" from the part number - ex. B-STK-30-#

Specify Color: "1" = White; "2" = Black; "3" = Charcoal; "5" = Flint Grey; "6" = Royal Blue; "9" = Platinum (see Page 31 for finishes)

basic PDUs

Basic Power Distribution

Model	Voltage	Amp/kW	Input	Output	Form Factor (LxWxD)	Description
PB11510-01	120V	15A	5-15P	(10) NEMA 5-15	17.5"x1.72"x1.72"	Basic 17.5" Horizontal PDU, 120V 15A, (10) NEMA 5-15 outlets, 5-15P input plug
PB11518-01	120V	15A	5-15P	(18) NEMA 5-15	29.5"x1.72"x1.72"	Basic 29.5" Vertical PDU, 120V 15A, (18) NEMA 5-15 outlets, 5-15P input plug
PB11524-01	120V	15A	5-15P	(24) NEMA 5-15	66.5"x1.72"x1.72"	Basic 66.5" Vertical PDU, 120V 15A, (24) NEMA 5-15 outlets, 5-15P input plug
PB12010-01	120V	20A	L5-20P	(10) NEMA 5-20	17.5"x1.72"x1.72"	Basic 17.5" Horizontal PDU, 120V 20A, (10) NEMA 5-20 outlets, L5-20P input plug
PB12018-01	120V	20A	L5-20P	(18) NEMA 5-20	29.5"x1.72"x1.72"	Basic 29.5" Vertical PDU, 120V 20A, (18) NEMA 5-20 outlets, L5-20P input plug
PB12024-01	120V	20A	L5-20P	(24) NEMA 5-20	66.5"x1.72"x1.72"	Basic 66.5" Vertical PDU, 120V 20A, (24) NEMA 5-20 outlets, L5-20P input plug
PB13016-01	120V	30A	L5-30P	(16) NEMA 5-20	29.5"x2.18"x1.72"	Basic 29.5" Vertical PDU, 120V 30A, (16) NEMA 5-20 outlets, L5-30P input plug
PB13024-01	120V	30A	L5-30P	(24) NEMA 5-20	66.5"x2.18"x1.72"	Basic 66.5" Vertical PDU, 120V 30A, (24) NEMA 5-20 outlets, L5-30P input plug
PB22012-01	208V	20A	L6-20P	(12) IEC-320 C13	17.5"x1.72"x1.72"	Basic 17.5" Horizontal PDU, 208V 20A, (12) C13 outlets, L6-20P input plug w/ 10' cord
PB22018-01	208V	20A	L6-20P	(18) IEC-320 C13	29.5"x1.72"x1.72"	Basic 29.5" Vertical PDU, 208V 20A, (18) C13 outlets, L6-20P input plug w/ 10' cord
PB22024-01	208V	20A	L6-20P	(24) IEC-320 C13	66.5"x1.72"x1.72"	Basic 66.5" Vertical PDU, 208V 20A, (24) C13 outlets, L6-20P input plug w/ 10' cord
PB23016-01	208V	30A	L6-30P	(16) IEC-320 C13	29.5"x2.18"x1.72"	Basic 29.5" Vertical PDU, 208V 30A, (16) C13 outlets, L6-30P input plug w/ 10' cord
PB23024-01	208V	30A	L6-30P	(24) IEC-320 C13	66.5"x2.18"x1.72"	Basic 66.5" Vertical PDU, 208V 30A, (24) C13 outlets, L6-30P input plug w/ 10' cord
PB23024-02	208V	30A	L6-30P	(20) IEC-320 C13 (4) C19	66.5"x2.18"x1.72"	Basic 66.5" Vertical PDU, 208V 30A, (20) C13 outlets & (4) C19 outlets, L6-30P input plug w/ 10' cord

Basic PDU Features & Benefits

- **Multiple Power Distribution Options:** 120V, 208V, 15, 20 & 30-Amp power input feeds to maximize whip efficiency to your load.
- **Zero U and Rack-mount models:** Both vertical and horizontal unit form factors are available.
- **Unsurpassed Mounting Flexibility:** Complete offering of toolless mounting bars and side and recessed-mount brackets allow power to mount virtually anywhere in a rack.
- **Tested to UL60950-1:** Our PDUs are tested to the latest standard for IT equipment - UL60950-1.
- **Branch Circuit Protection:** All 30 amp PDU's are equipped with UL 489-listed circuit breakers and are 3.5" deep at the breaker box.



Available in IEC (shown left) or NEMA receptacle (shown right) configurations, Basic PDUs are a cost-effective means of delivering power to multiple pieces of equipment.



120V, 20A Basic PDU with NEMA 5-20 receptacles shown at the back of the rack with the receptacles facing up. This orientation is useful for preventing plugs from being pulled out.



Units equipped with branch circuit protection as required by UL60950-1 utilize UL489-listed circuit breakers.

metered PDUs

Metered Power Distribution

Model	Voltage	Amp/kW	Input	Output	Form Factor (LxWxD)	Description
PM12010-01	120V	20A	L5-20P	(10) NEMA 5-20	17.5"x1.72"x1.72"	Metered 17.5" Horizontal PDU, 120V 20A, (10) NEMA 5-20 outlets, L5-20P input plug w/ 10' cord
PM12018-01	120V	20A	L5-20P	(18) NEMA 5-20	29.5"x1.72"x1.72"	Metered 29.5" Vertical PDU, 120V 20A, (18) NEMA 5-20 outlets, L5-20P input plug w/ 10' cord
PM12024-01	120V	20A	L5-20P	(24) NEMA 5-20	66.5"x1.72"x1.72"	Metered 66.5" Vertical PDU, 120V 20A, (24) NEMA 5-20 outlets, L5-20P input plug w/ 10' cord
PM13016-01	120V	30A	L5-30P	(16) NEMA 5-20	29.5"x2.18"x1.72"	Metered 29.5" Vertical PDU, 120V 30A, (16) NEMA 5-20 outlets, L5-30P input plug w/ 10' cord
PM13024-01	120V	30A	L5-30P	(24) NEMA 5-20	66.5"x2.18"x1.72"	Metered 66.5" Vertical PDU, 120V 30A, (24) NEMA 5-20 outlets, L5-30P input plug w/ 10' cord
PM22012-01	208V	20A	L6-20P	(12) IEC-320 C13	17.5"x1.72"x1.72"	Metered 17.5" Horizontal PDU, 208V 20A, (12) C13 outlets, L6-20P input plug w/ 10' cord
PM22018-01	208V	20A	L6-20P	(18) IEC-320 C13	29.5"x1.72"x1.72"	Metered 29.5" Vertical PDU, 208V 20A, (18) C13 outlets, L6-20P input plug w/ 10' cord
PM22024-01	208V	20A	L6-20P	(24) IEC-320 C13	66.5"x1.72"x1.72"	Metered 66.5" Vertical PDU, 208V 20A, (24) C13 outlets, L6-20P input plug w/ 10' cord
PM23016-01	208V	30A	L6-30P	(16) IEC-320 C13	29.5"x2.18"x1.72"	Metered 29.5" Vertical PDU, 208V 30A, (16) C13 outlets, L6-30P input plug w/ 10' cord
PM23024-01	208V	30A	L6-30P	(24) IEC-320 C13	66.5"x2.18"x1.72"	Metered 66.5" Vertical PDU, 208V 30A, (24) C13 outlets, L6-30P input plug w/ 10' cord
PM23024-02	208V	30A	L6-30P	(20) IEC-320 C13 (4) C19	66.5"x2.18"x1.72"	Metered 66.5" Vertical PDU, 208V 30A, (20) C13 & (4) C19 outlets, L6-30P input plug w/ 10' cord

Metered PDU Features & Benefits

- **Input Current Monitoring:** Precisely measure the aggregate current draw (in amps) on each power circuit utilizing a true RMS meter to avoid overloading circuits. On-site verification of the current draw via the LED digital display.
- **Multiple Power Distribution Options:** 120V, 208V, 15, 20 & 30-Amp power input feeds to maximize whip efficiency to your load.
- **Zero U and Rack-Mount Models:** Both vertical and horizontal unit form factors are available.
- **Unsurpassed Mounting Flexibility:** Complete offering of toolless mounting bars and side and recessed-mount brackets allow power to mount virtually anywhere in a rack.
- **Tested to UL60950-1:** Our PDUs are tested to the latest standard for IT equipment - UL60950-1.
- **Branch Circuit Protection:** All 30 amp PDU's are equipped with UL489-listed circuit breakers and are 3.5" deep at the breaker box.



True RMS local meters on the PDU provide accurate current measurements to quickly identify remaining capacity, allowing for informed decisions about adding additional equipment.

outlet/plug guide



metered power distribution

outlet/plug

low-profile power strips

Vertical Power Strips - 120V, 15 Amp - No Switch/No Breaker



Part Number	Length	Fits Frame Sizes	Receptacle Quantity	Receptacle Type	Cord Length	Plug Type
PW-7212-15-2-0	72"	40 - 50U	12	NEMA 5-15	9 ft.	5-15P
PW-7224-15-2-0	72"	40 - 50U	24	NEMA 5-15	9 ft.	5-15P

- Low-profile design minimizes rack space interference
- Profile dimensions (WxD): 1.28" x 0.875" (does not include mounting brackets)
- Receptacles spaced on 6" centers – allows mounting of transformers
- Includes mounting clips, brackets and hardware for attachment to front-to-back members
- UL listed components

Vertical Power Strips - 120V, 20 Amp - No Switch/No Breaker



Part Number	Length	Fits Frame Sizes	Receptacle Quantity	Receptacle Type	Cord Length	Plug Type
PW-7212-20-2-1	72"	40 - 50U	12	NEMA 5-15	9 ft.	5-20P
PW-7212-20-2-5	72"	40 - 50U	12	NEMA 5-15	9 ft.	L5-20P (Twistlock)
PW-7212-20-N-N	72"	40 - 50U	12	NEMA 5-15	None	3 Wire Lead
PW-7224-20-2-1	72"	40 - 50U	24	NEMA 5-15	9 ft.	5-20P
PW-7224-20-2-5	72"	40 - 50U	24	NEMA 5-15	9 ft.	L5-20P (Twistlock)
PW-7224-20-N-N	72"	40 - 50U	24	NEMA 5-15	None	3 Wire Lead

- Low-profile design minimizes rack space interference
- Profile dimensions (WxD): 1.28" x 0.875" (does not include mounting brackets)
- Receptacles spaced on 6" centers – allows mounting of transformers
- Includes mounting clips, brackets and hardware for attachment to front-to-back members
- UL listed components

Vertical Power Strips - 120V, 15 Amp - No Switch/No Breaker - Isolated Ground



Part Number	Length	Fits Frame Sizes	Receptacle Quantity	Receptacle Type	Cord Length	Plug Type
PWI-7212-15-2-0	72"	40 - 50U	12	NEMA 5-15	9 ft.	5-15P
PWI-7224-15-2-0	72"	40 - 50U	24	NEMA 5-15	9 ft.	5-15P

- Low-profile design minimizes rack space interference
- Orange receptacles (not shown) for easy identification of isolated ground units
- Profile dimensions (WxD): 1.28" x 0.875" (does not include mounting brackets)
- Receptacles spaced on 6" centers – allows mounting of transformers
- Includes mounting clips, brackets and hardware for attachment to front-to-back members
- UL listed components

Vertical Power Strips - 120V, 20 Amp - No Switch/No Breaker - Isolated Ground



Part Number	Length	Fits Frame Sizes	Receptacle Quantity	Receptacle Type	Cord Length	Plug Type
PWI-7212-20-2-1	72"	40 - 50U	12	NEMA 5-15	9 ft.	5-20P
PWI-7212-20-2-5	72"	40 - 50U	12	NEMA 5-15	9 ft.	L5-20P (Twistlock)
PWI-7212-20-N-N	72"	40 - 50U	12	NEMA 5-15	None	3 Wire Lead
PWI-7224-20-2-1	72"	40 - 50U	24	NEMA 5-15	9 ft.	5-20P
PWI-7224-20-2-5	72"	40 - 50U	24	NEMA 5-15	9 ft.	L5-20P (Twistlock)
PWI-7224-20-N-N	72"	40 - 50U	24	NEMA 5-15	None	3 Wire Lead

- Low-profile design minimizes rack space interference
- Orange receptacles (not shown) for easy identification of isolated ground units
- Profile dimensions (WxD): 1.28" x 0.875" (does not include mounting brackets)
- Receptacles spaced on 6" centers – allows mounting of transformers
- Includes mounting clips, brackets and hardware for attachment to front-to-back members
- UL listed components

additional solutions

■ Contain-IT™

AISLE CONTAINMENT

- Retrofit to almost any installation
- Translucent panels allow light to pass for improved visibility
- Sliding doors minimize the space required versus swinging door solutions
- Levelers accommodate uneven flooring to align doors
- Brush seals help prevent leakage
- Modular design speeds installation
- Translucent material has an ASTM E84 Class I Fire-Rating
- FM 4910 approved insert option



■ Smart Power

IP-ADDRESSABLE POWER SOLUTIONS

- Remotely Reboot Equipment
- Turn individual receptacles on or off
- Precisely measure and monitor the input current
- 120V, 208V & 3-phase power options
- Link Master & Expansion units for management of separate circuits from a single IP address
- Power-up Sequencing to prevent in-rush power overloads
- IP Access & Security includes Web interface, SSL, SSH, Telnet, SNMP or RS-232 access
- Environmental Monitoring of temperature and humidity thru the Web interface
- SNMP Traps automate alerts for undesirable conditions
- Multiple PDU Access available to organize and allow access of up to 1,000 PDUs from a single Web interface



finishes



1 = White

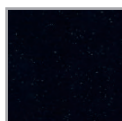

2 = Black



3 = Charcoal



5 = Flint Grey



6 = Royal Blue



9 = Platinum

Finishes are a textured powder coat. Colors shown are representative.
Color swatches are available upon request.



THE POWER OF



A Group brand



1443 South Sunkist Street
Anaheim, CA 92806
800.433.6745
T 714.776.5420
F 714.776.9683
E info@electrorack.com
www.electrorack.com