

# Low Voltage, Branch Circuit Rated Fuses

Fuse Holder & Block Selection Guide	Page 12-14
Class Fuse Dimensions	15-16
Fuses By Fuse Class	

Low Voltage Branch Circuit Fuses

<u>Class</u>	<u>Fuses</u>	<u>Volts</u>	
CC .....	LP-CC .....	600V .....	17
	FNQ-R .....	600V .....	18
	KTK-R .....	600V .....	19
CF .....	TCF* & TCFH_N .....	600V .....	20-21
	*Class J performance		
G .....	SC .....	600/480V ..	22
J .....	LPJ-_SP .....	600V .....	23
	LPJ-_SPI Indicator .....	600V .....	23
	JKS .....	600V .....	24
K5 & H ...	NON .....	250V .....	25
	NOS .....	600V .....	25
L .....	KRP-C_SP .....	600V .....	26-27
	KRP-CL .....	600V .....	27
	KLU .....	600V .....	28
	KTU .....	600V .....	28
RK1 .....	LPN-RK_SP .....	250V .....	29-31
	LPN-RK_SPI Indicator ...	250V .....	29-31
	LPS-RK_SP .....	600V .....	29-31
	LPS-RK_SPI Indicator ...	600V .....	29-31
	KTN-R .....	250V .....	32
	<b>KWS-R .....</b>	<b>600V .....</b>	<b>33</b>
RK5 .....	DLN-R .....	250V .....	34
	DLS-R .....	600V .....	34
	FRN-R .....	250V .....	35
	FRS-R .....	600V .....	36
	<b>PVS-R .....</b>	<b>600V .....</b>	<b>37</b>
T .....	JJN .....	300V .....	38
	JJS .....	600V .....	39
Plug Fuses	W, SL, TL, S,		
	T, P, TC Series & MB		
	Edison Base Circuit		
	Breakers, SA .....	125V .....	40-42

RED indicates NEW information

## Holders & Blocks For Branch Circuit Rated Fuses

Class	Fuses	Volts	Page
CC	LP-CC	600V .....	17
	FNQ-R	600V .....	18
	KTK-R	600V .....	19

### Holders

• OPM-NG-SC3 3-pole, panel/DIN rail mount .....	252
• OPM-1038R 3-pole, panel/DIN rail mount .....	251
• OPM-1038RSW 3-pole w/ switch, panel/DIN rail mount ..	250
• CHCC_D 1 to 3-pole, DIN rail mount .....	257
• HPF-RR, front panel mount .....	286
• HPS-RR, front panel mount .....	286

### Blocks

• BC Series, panel mount .....	274
--------------------------------	-----

### Disconnects

• CDF30J3 fusible disconnect switches .....	330
• FD400J3 fusible disconnect switches .....	340



OPM-NG-SC3



OPM-1038R &  
OPM-1038RSW



CHCC\_D



HPF-RR



HPS-RR



BC Series



CFD30J3

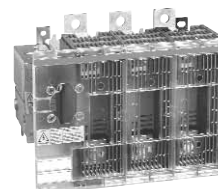

FD400J3



EFJ30X-3PB6

Class	Fuses	Volts	Page
G	SC	600/480V .....	22

### Holders

• HP Series front panel accessible, front panel mount .....	286
---	-----

### Blocks

• BG Series, panel/DIN rail with adapters .....	274
• G Series, panel/DIN rail with adapters .....	274



HP Series



BG & G Series

Class	Fuses	Volts	Page
K5 & H	NON	250V .....	25
	NOS	600V .....	25

### Blocks

• Modular Type Fuse Blocks 250/600V, panel mount .....	275
• H250 Series 1 to 3-pole 250V, panel mount .....	260
• H600 Series 1 to 3-pole 600V, panel mount .....	263



Modular Type



H250 Series



H600 Series

## Holders & Blocks For Branch Circuit Rated Fuses

Class	Fuses	Volts	Page
L	KRP-C_SP	600V .....	26
	KRP-CL	600V .....	27
	KLU	600V .....	28
	KTU	600V .....	28

### Blocks

- 51215 1-pole, panel mount\*
- 51235 3-pole, panel mount\*

\*Call our customer satisfaction team at 636-527-3877 for more information.

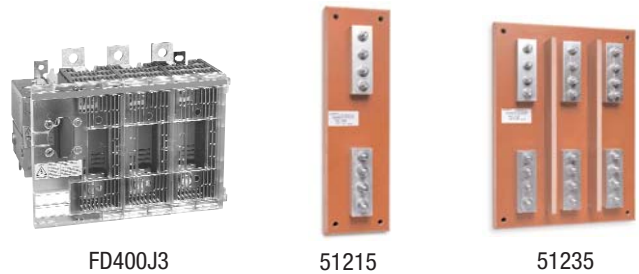

FD400J3

51215

51235

Low Voltage Branch Circuit Fuses

### Disconnects

- FD800L3 fusible disconnect switches ..... 340

Class	Fuses	Volts	Page
RK1	LPN-RK_SP	250V .....	29
	LPS-RK_SP	600V .....	29
	KTN-R	250V .....	32
	KWS-R	600V .....	33

### Blocks

- R250 Series 1- to 3-pole 250V, panel mount ..... 260
- R600 Series 1- to 3-pole 600V, panel mount ..... 263



R250 Series

R600 Series

Class	Fuses	Volts	Page
RK5	DLN-R	250V .....	34
	DLS-R	600V .....	34
	FRN-R	250V .....	35
	FRS-R	600V .....	36

### Blocks

- R250 Series 1- to 3-pole 250V, panel mount ..... 260
- R600 Series 1- to 3-pole 600V, panel mount ..... 263



R250 Series

R600 Series

Class	Fuses	Volts	Page
T	JJN	300V .....	38
	JJS	600V .....	39

### Blocks

- BH Series modular-style, panel mount (<60A) ..... 275
- T300 Series 1 to 4-pole 300V, panel mount ..... 269
- T600 Series 1 to 3-pole 600V, panel mount ..... 271

### Disconnects

- CDF30J3 fusible disconnect switches..... 330
- FD400J3 fusible disconnect switches ..... 340



BH Series

T300 Series

T600 Series

## Holders & Blocks For Branch Circuit Rated Fuses

Class	Fuses	Volts	Page
J, CF	TCF*	600V .....	20
	LPJ-SP	600V .....	23
	JKS	600V .....	24

\*Class J performance

### Holders

- TCFH CUBEFuse™ holder, panel/DIN rail mount ..... 20-21
- CH Series Class J modular 1- to 3-pole, panel/DIN rail mount ..... 254
- Safety J™ Series modular holders, panel/DIN rail mount ..... 255

### Blocks

- Modular Type Fuse Blocks 600V, panel mount ..... 275
- J600 Series, panel mount ..... 266
- JP Series pyramid blocks, panel mount ..... 267
- BH Series modular-style open blocks, panel mount ..... 275

### Disconnects

#### Disconnects

- CDF30J3 fusible disconnect switches ..... 330
- FD400J3 fusible disconnect switches ..... 340



TCFH

CH Series

Safety J™ Series

Modular Type



J600 Series

JP Series

BH Series

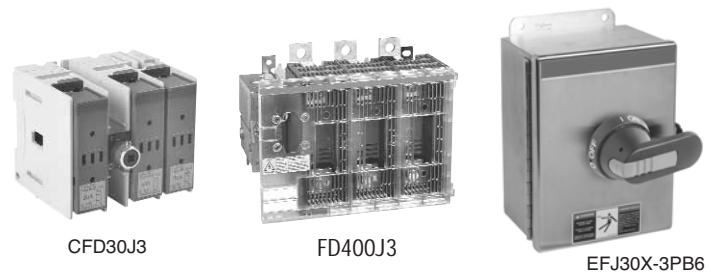

CDF30J3

FD400J3

EFJ30X-3PB6

Class	Fuses	Volts	Page
Plug Fuses	W, SL, TL, S, T, P and TC Series	125V .....	40-41

### Box Cover Units

- Standard electrical box mounting ..... 276



Fuse Only

With Grounded Outlet

With Switch

### Fuse Reducers For Class R Fuses 250V

Equipment Fuse Clip Amps	Desired Fuse (Case) Amp Size	Catalog No. (Pairs) 250V
60	30	NO.263-R
100	30	NO.213-R
	60	NO.216-R
200	60	NO.226-R
	100	NO.2621-R
400	100	NO.2641-R
	200	NO.242-R
600	100	NO.2661-R
	200	NO.2662-R
	400	NO.2664-R*

\*Single reducer only (pair not required).

### Fuse Reducers For Class R Fuses 600V

Equipment Fuse Clip Amps	Desired Fuse (Case) Amp Size	Catalog No. (Pairs) 600V
60	30	NO.663-R
100	30	NO.216-R
	60	NO.616-R
200	60	NO.626-R
	100	NO.2621-R
400	100	NO.2641-R
	200	NO.642-R
600	100	NO.2661-R
	200	NO.2662-R
	400	NO.2664-R*

\*Single reducer only (pair not required).

## Branch Circuit Rated Fuse Dimensions

### Class J Dimensions - in (mm)

Low-Peak® and Limitron® Fuses  
LPJ & JKS — 600V

Amp Range	A	B	C	D	E	F	G	H	I
1-30	2.25 (57.2)	0.81 (20.6)	—	—	0.50 (12.7)	—	—	—	—
35-60	2.38 (60.3)	1.06 (27.0)	—	—	0.63 (15.9)	—	—	—	—
65-100	4.63 (117.5)	1.13 (28.6)	3.63 (92.1)	2.63 (66.7)	1.00 (25.4)	0.75 (28.6)	0.13 (3.2)	0.41 (10.4)	0.28 (7.1)
110-200	5.75 (146.1)	1.63 (41.4)	4.38 (111.1)	3.00 (76.2)	1.38 (34.9)	1.13 (28.6)	0.19 (4.8)	0.38 (9.5)	0.28 (7.1)
225-400	7.12 (181.0)	2.11 (53.6)	5.25 (133.3)	3.26 (82.8)	1.87 (47.6)	1.62 (41.2)	0.25 (6.4)	0.56 (14.2)	0.40 (10.3)
450-600	8.00 (203.2)	2.60 (66.0)	6.00 (152.4)	3.31 (84.0)	2.12 (54.0)	2.00 (50.8)	0.53 (13.5)	0.72 (18.3)	0.53 (13.5)

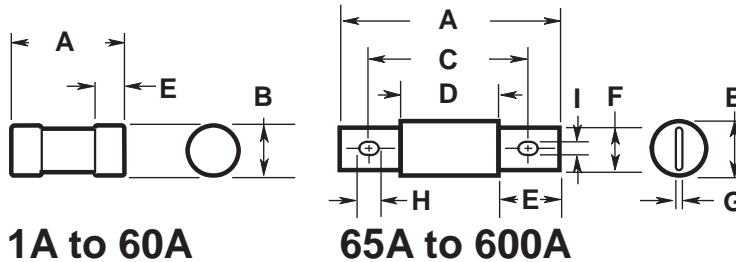

### Class CC Dimensions - in (mm)

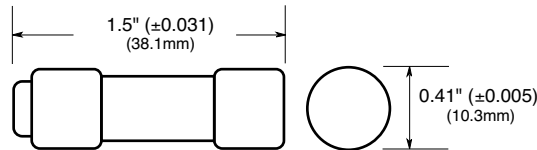

### Class RK1 & RK5 Dimensions - in (mm)

Basic dimensions are same as Class H (formerly NEC) One-Time (NON & NOS) and Superlag Renewable RES & REN fuses.  
NOTE: These fuses can be used to replace existing Class H, RK1 and RK5 fuses relating to dimensional compatibility.

#### Ferrule Styles

Amp Range	250V		600V	
	A	B	A	B
1/16-30	2 (50.8)	0.56 (14.3)	5.0 (127.0)	0.81 (20.6)
35-60	3 (76.2)	0.81 (20.6)	5.5 (139.7)	1.06 (27.0)

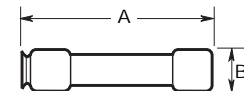

#### Fusetron® — (FRN-R & FRS-R) & Limitron® — (KTN-R & KTS-R)

Amp Range	250V		600V	
	A	B	A	B
70-100	5.88 (149.2)	1.06 (26.9)	7.88 (200.0)	1.34 (34.0)
110-200	7.13 (181.0)	1.56 (39.6)	9.63 (244.5)	1.84 (46.7)
225-400	8.63 (219.1)	2.38 (60.5)	11.63 (295.3)	2.59 (65.8)
450-600	10.38 (263.5)	2.88 (73.2)	13.38 (339.7)	3.13 (79.5)

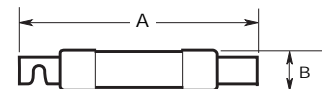

#### Low-Peak® — (LPN-RK & LPS-RK)

Amp Range	250V		600V	
	A	B	A	B
70-100	5.88 (149.2)	1.16 (29.5)	7.88 (200.0)	1.16 (29.5)
110-200	7.13 (181.0)	1.66 (42.2)	9.63 (244.5)	1.66 (42.2)
225-400	8.63 (219.1)	2.38 (60.5)	11.63 (295.3)	2.38 (60.5)
450-600	10.38 (263.5)	2.88 (73.2)	13.38 (339.7)	2.88 (73.2)

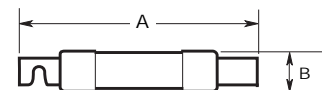

## Branch Circuit Rated Fuse Dimensions

### Class L Dimensions - in (mm)

#### Low-Peak® and Limitron® Fuses

Amp Range	A	B	C1	C2	D	F	G	I	J1	J2	J3	J4
601-800	8.63 (219.1)	2.40 (61.0)	6.75 (171.5)	5.75 (146.1)	3.75 (95.3)	2.00 (50.8)	0.38 (9.5)	0.63 (15.9)	—	—	—	—
801-1200	10.75 (273.1)	2.40 (61.0)	6.75 (171.5)	5.75 (146.1)	3.75 (95.3)	2.00 (50.8)	0.38 (9.5)	0.63 (15.9)	—	—	—	—
1350-1600	10.75 (273.1)	3.00 (76.2)	6.75 (171.5)	5.75 (146.1)	3.75 (95.3)	2.38 (60.3)	0.44 (11.1)	0.63 (15.9)	—	—	—	—
1800-2000	10.75 (273.1)	3.50 (88.9)	6.75 (171.5)	5.75 (146.1)	3.75 (95.3)	2.75 (69.9)	0.50 (12.7)	0.63 (15.9)	—	—	—	—
2001-2500	10.75 (273.1)	4.80 (122.0)	6.75 (171.5)	5.75 (146.1)	3.75 (95.3)	3.50 (88.9)	0.75 (19.1)	0.63 (15.9)	1.75 (44.5)	1.38 (34.9)	0.88 (22.2)	0.81 (20.6)
3000	10.75 (273.1)	5.00 (127.0)	6.75 (171.5)	5.75 (146.1)	3.75 (95.3)	4.00 (101.6)	0.75 (19.1)	0.63 (15.9)	1.75 (44.5)	1.38 (34.9)	0.88 (22.2)	0.81 (20.6)
3500-4000	10.75 (273.1)	5.75 (146.1)	6.75 (171.5)	5.75 (146.1)	3.75 (95.3)	4.75 (120.7)	0.75 (19.1)	0.63 (15.9)	1.75 (44.5)	1.38 (34.9)	1.63 (41.3)	0.88 (22.2)
4500-5000	10.75 (273.1)	6.25 (158.8)	6.75 (171.5)	5.75 (146.1)	3.75 (95.3)	5.25 (133.4)	1.00 (25.4)	0.63 (15.9)	1.75 (44.5)	1.38 (34.9)	1.63 (41.3)	0.88 (22.2)
6000	10.75 (273.1)	7.13 (181.0)	6.75 (171.5)	5.75 (146.1)	3.75 (95.3)	5.75 (146.1)	1.00 (25.4)	0.63 (15.9)	1.75 (44.5)	1.38 (34.9)	1.63 (41.3)	0.88 (22.2)

NOTE: KRP-CL (150A to 600A) fuses have same dimensions as 601-800A case size. KTU (200-600A) have same dimensions, except tube 3" length x 2" diameter (76.2 x 50.8mm); terminal 1 1/8" width x 1 1/4" thick (41.3 x 31.8mm).

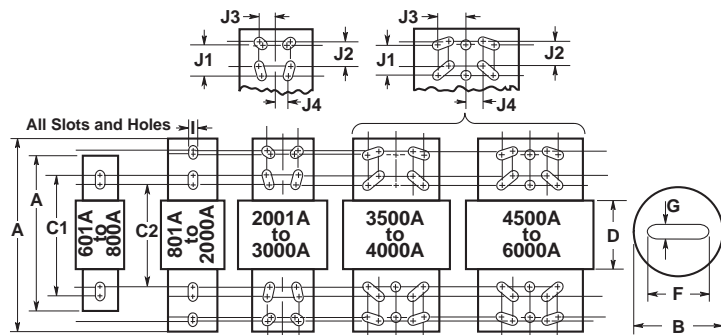

### Class T Dimensions - in (mm)

#### T-Tron® Fuses

##### JJN — 300V

Amp Range	A	B	C	D
1-30	0.88 (22.2)	0.41 (10.3)	—	—
35-60	0.88 (22.2)	0.56 (14.3)	—	—
70-100	2.16 (54.8)	0.75 (19.1)	1.56 (39.7)	0.84 (21.4)
110-200	2.44 (61.9)	0.88 (22.2)	1.69 (42.9)	0.84 (21.4)
225-400	2.75 (69.9)	1.00 (25.4)	1.84 (46.8)	0.86 (21.8)
450-600	3.06 (77.8)	1.25 (31.8)	2.03 (51.6)	0.88 (22.2)
601-800	3.38 (85.7)	1.75 (44.5)	2.22 (56.4)	0.89 (22.6)
801-1200	4.00 (101.6)	2.00 (50.8)	2.53 (64.3)	1.08 (27.4)

##### JJS — 600V

Amp Range	A	B	C	D
1-30	1.50 (38.1)	0.56 (14.3)	—	—
35-60	1.56 (39.7)	0.81 (20.6)	—	—
70-100	2.95 (75.0)	0.75 (19.1)	2.36 (59.9)	1.64 (41.7)
110-200	3.25 (82.6)	0.88 (22.2)	2.50 (63.5)	1.66 (42.1)
225-400	3.63 (92.1)	1.00 (25.4)	2.72 (69.1)	1.73 (44.1)
450-600	3.98 (101.2)	1.25 (31.8)	2.96 (75.0)	1.78 (45.2)
601-800	4.33 (109.9)	1.75 (44.5)	3.17 (80.6)	1.88 (47.6)

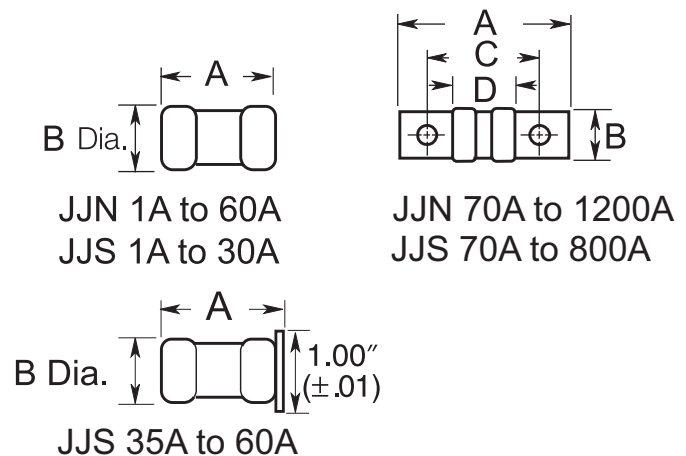

## Low-Peak® Time-delay, Rejection-Type Fuses

Low Voltage Branch Circuit Fuses

### LP-CC Class CC

#### Specifications

**Description:** Time-delay, current-limiting, rejection-type fuse – 12 seconds (minimum) at 200% rated amps.

**Dimensions:** 1<sup>3</sup>/<sub>2</sub>" x 1 1<sup>1</sup>/<sub>2</sub>" (10.3 x 38.1mm).

#### Ratings:

- Volts — 600Vac (or less)
- 300Vdc (½-2<sup>3</sup>/<sub>10</sub>A & 20-30A)
- 150Vdc (3-15A)
- Amps — ½-30A
- IR — 200kA RMS Sym.
- 20kA DC



**Agency Information:** CE, Std. 248-4, Class CC, UL Listed, Guide JDDZ, File E4273, CSA Certified; Class 1422-02, File 53787.

#### Features and Benefits

- Time delay coupled with Class CC current-limiting response provides close sizing on small motor and relay circuits, and maximum component short-circuit current rating protection.
- 200kA interrupting rating provides high ratings for control circuit locations.
- Class CC rejection feature, with appropriate fuse block, prevents inserting lesser-rated supplementary fuses.
- Inventory consolidation of 1<sup>3</sup>/<sub>2</sub> x 1 1<sup>1</sup>/<sub>2</sub> inch supplementary fuses reduces SKU investment and minimizes potential for misapplying fuse.
- Selective coordination ratio of 2:1 (within Low-Peak fuse family) prevents electrical shutdowns from extending beyond the failed circuit.

#### Typical Applications

- Specialized Circuits
- Industrial Control
- Isolated, In-Line Fuse Holder

#### Catalog Numbers (Amps)

LP-CC-½	LP-CC-2-½	LP-CC-7 ½
LP-CC-¾	LP-CC-2-¾	LP-CC-8
LP-CC-¾	LP-CC-3	LP-CC-9
LP-CC-1	LP-CC-3-¾	LP-CC-10
LP-CC-1-½	LP-CC-3-½	LP-CC-12
LP-CC-1-¼	LP-CC-4	LP-CC-15
LP-CC-1-¾	LP-CC-4-½	LP-CC-20
LP-CC-1-½	LP-CC-5	LP-CC-25
LP-CC-1-¾	LP-CC-5-¾	LP-CC-30
LP-CC-1-¾	LP-CC-6	
LP-CC-2	LP-CC-6-¼	
LP-CC-2-¼	LP-CC-7	

#### Time Current Characteristics—Average Melt

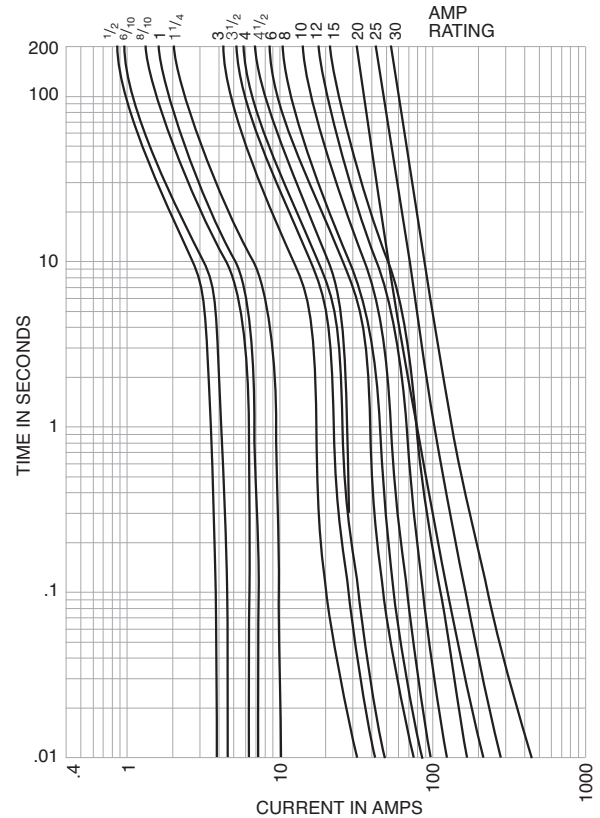

#### Current Limitation Curves

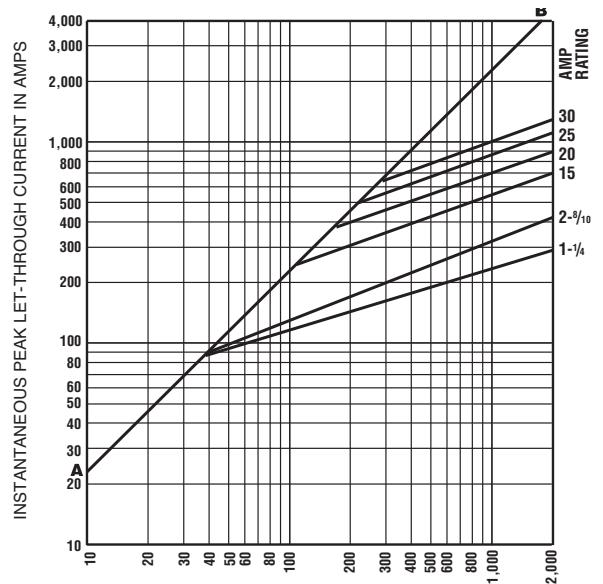

PROSPECTIVE SHORT-CIRCUIT CURRENT—SYMMETRICAL RMS AMPS

#### Recommended Fuse Holders & Blocks For Class CC Fuses

- See page 12

## CC-Tron® Rejection-type Fuses

### FNQ-R Class CC

#### Specifications

**Description:** Time-delay, branch circuit, rejection-type fuse.

**Dimensions:** 1<sup>3</sup>/<sub>32</sub>" x 1 1/2" (10.3 x 38.1mm).

#### Ratings:

Volts — 600Vac (or less); 300Vdc (15-20A)

Amps — 1/4-30A

IR — 200kA RMS Sym.; 20kA DC

**Agency Information:** CE, Std. 248-4, Class CC, UL Listed, Guide JDDZ, File E4273 CSA Certified, Class 1422-01, File 53787.



#### Features and Benefits

- Time delay compatible with inrush characteristic of small control transformers.
- Current limitation at Class CC levels provides maximum component short-circuit current rating protection.
- 200kA interrupting rating provides high ratings for control circuit locations.
- Class CC rejection feature, with appropriate fuse block, prevents inserting lesser-rated supplementary fuses.

#### Typical Applications

- Line Protection, Small Control Transformers
- Industrial Control
- Isolated, In-Line Fuse Holders

#### Catalog Numbers (Amps)

FNQ-R-1/4	FNQ-R-1-9/10	FNQ-R-6
FNQ-R-3/10	FNQ-R-1-3/10	FNQ-R-6-1/4
FNQ-R-1/10	FNQ-R-2	FNQ-R-7
FNQ-R-1/2	FNQ-R-2-1/4	FNQ-R-7-1/2
FNQ-R-3/10	FNQ-R-2-1/2	FNQ-R-8
FNQ-R-3/4	FNQ-R-2-9/10	FNQ-R-9
FNQ-R-9/10	FNQ-R-3	FNQ-R-10
FNQ-R-1	FNQ-R-3-3/10	FNQ-R-12
FNQ-R-1-1/10	FNQ-R-3-1/2	FNQ-R-15
FNQ-R-1-1/4	FNQ-R-4	FNQ-R-17-1/2
FNQ-R-1-3/10	FNQ-R-4-1/2	FNQ-R-20
FNQ-R-1-1/10	FNQ-R-5	FNQ-R-25
FNQ-R-1-1/2	FNQ-R-5-9/10	FNQ-R-30

Time-Current Characteristic Curves—Average Melt

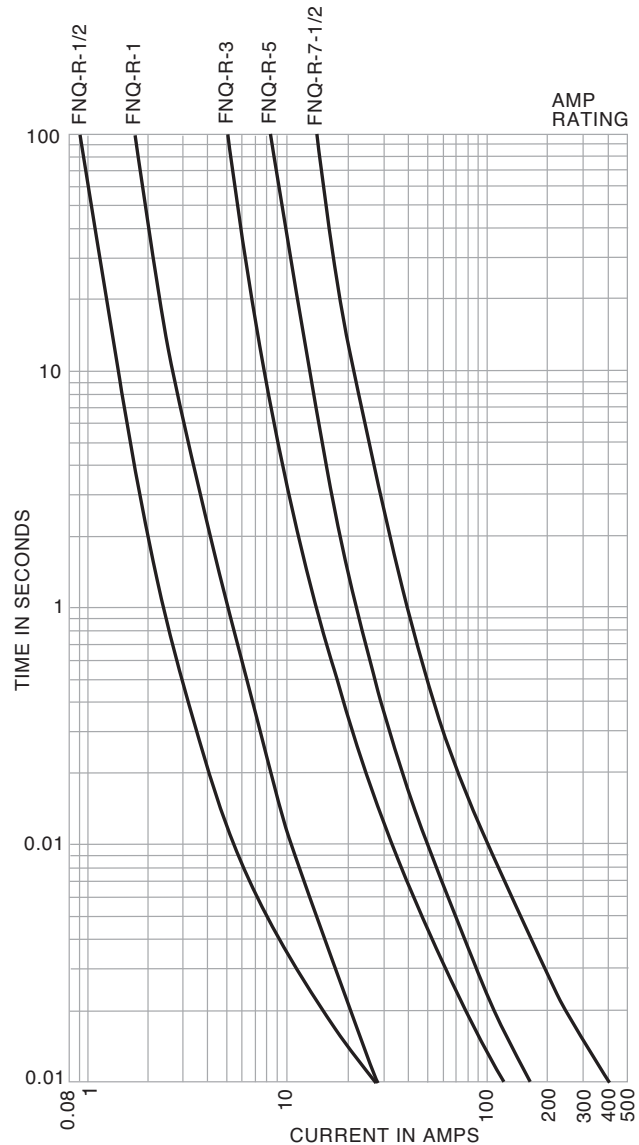

For superior electrical protection, Cooper Bussmann recommends upgrading FNQ-R fuse applications to Low-Peak LP-CC fuses See page 17.

#### Recommended Fuse Holders & Blocks For Class CC 600V Fuses

- See page 12

## Limitron® Rejection-type Fuses

### KTK-R Class CC

#### Specifications

**Description:** Fast-acting, branch circuit, rejection-type fuse.

**Dimensions:** 1 1/2" x 1 1/2" (10.3 x 38.1mm).

#### Ratings:

Volts — 600Vac (or less)

Amps — 1/10-30A

IR — 200kA RMS Sym.

**Agency Information:** CE, Std. 248-4, Class CC, UL Listed, Guide JDDZ, File E4273 CSA Certified, File 53787, Class 1422-02.



#### Features and Benefits

- Current limitation at Class CC levels provides maximum component short-circuit current protection.
- 200kA interrupting rating provides high ratings for control circuit locations.
- Class CC rejection feature, with appropriate fuse block, prevents inserting lesser-rated supplementary fuses.

#### Typical Applications

- Specialized Circuits
- Industrial Control
- Isolated, In-Line Fuse Holders (street lighting)

#### Catalog Numbers (Amps)

KTK-R-1/10	KTK-R-1	KTK-R-7
KTK-R-1/8	KTK-R-1-1/2	KTK-R-8
KTK-R-2/10	KTK-R-2	KTK-R-9
KTK-R-1/4	KTK-R-2-1/2	KTK-R-10
KTK-R-3/10	KTK-R-3	KTK-R-12
KTK-R-1/2	KTK-R-3-1/2	KTK-R-15
KTK-R-2/5	KTK-R-4	KTK-R-20
KTK-R-3/5	KTK-R-5	KTK-R-25
KTK-R-1/2	KTK-R-6	KTK-R-30

Time-Current Characteristic Curves—Average Melt

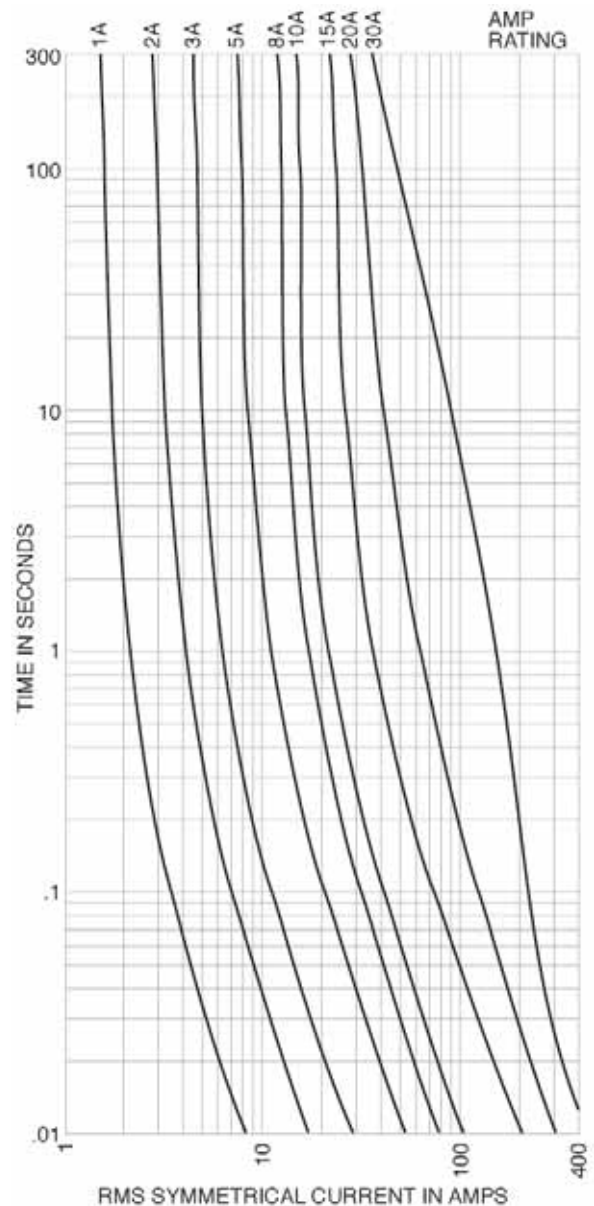

For superior electrical protection, Cooper Bussmann recommends upgrading KTK-R fuse applications to Low-Peak LP-CC fuses See page 17.

#### Recommended Fuse Holders & Blocks For Class CC Fuses

- See page 12

## CUBEFuse® Finger-safe Fuse and Fuse Holder System

### TCF & TCF\_RN (fuse) Class CF TCFH\_N (holder)

*Available With  
Indication*



#### Specifications

**Description:** Finger-safe fuse and fuse holder system; dual-element, time-delay fuse; 10 seconds minimum operating time at 500% rated amps.

**Dimensions:** See Dimensions illustration.

**Poles:** 1-pole (gangable)

#### Ratings:

Volts — 600Vac (or less)  
— 300Vdc (or less)

Amps — 1-100A

IR — 300kA RMS Sym. (UL)  
— 200kA RMS Sym. (CSA)  
— 100kA DC (UL & CSA)

**Agency Information:** CE, UL Listed Guide JFHR, File E4273, CSA Certified Fuse: Class 1422- 02, File 53787, UL Listed Fuse holder: Guide IZND, File E214079, CSA Certified Fuse holder: Class 6225-01, File 47235.

#### Features and Benefits

- Separate overload and short-circuit elements provide time delay for sizing of high inrush loads linked with Class J current limitation.
- Selective coordination ratio of 2:1 (within Low-Peak fuse family) prevents electrical shutdowns from extending beyond the failed circuit.
- Smallest footprint of any Class CC, J, T or RK fuse provides substantial space savings and installation flexibility.
- IEC 60529 and finger-safe rating provides enhanced workplace safety.

#### Typical Applications

- Electrical Panelboards
- Machinery Disconnects
- Industrial Control
- Required Finger-Safe Systems

#### Fuse Catalog Numbers Indicating (Amps)

TCF6	TCF25	TCF50	TCF100
TCF10	TCF30	TCF60	
TCF15	TCF35	TCF70	
TCF17-½	TCF40	TCF80	
TCF20	TCF45	TCF90	

#### Fuse Catalog Numbers Non-Indicating (Amps)

TCF1RN	TCF17-½RN	TCF40RN	TCF80RN
TCF3RN	TCF20RN	TCF45RN	TCF90RN
TCF6RN	TCF25RN	TCF50RN	TCF100RN
TCF10RN	TCF30RN	TCF60RN	
TCF15RN	TCF35RN	TCF70RN	

#### Fuse Holder Catalog Numbers

Catalog Numbers	Amp Range	Wire Range* Single Wire	Dual Wire
TCFH30N	1-30	14 to 8 AWG Cu	18 to 10 AWG
TCFH60N	1-60	14 to 4 AWG Cu	10 to 6 AWG Cu
TCFH100N	1-100	10 to 1 AWG Cu	6 AWG Cu

\*75°C minimum Cu wire only.

#### Time-Current Characteristic Curves—Average Melt

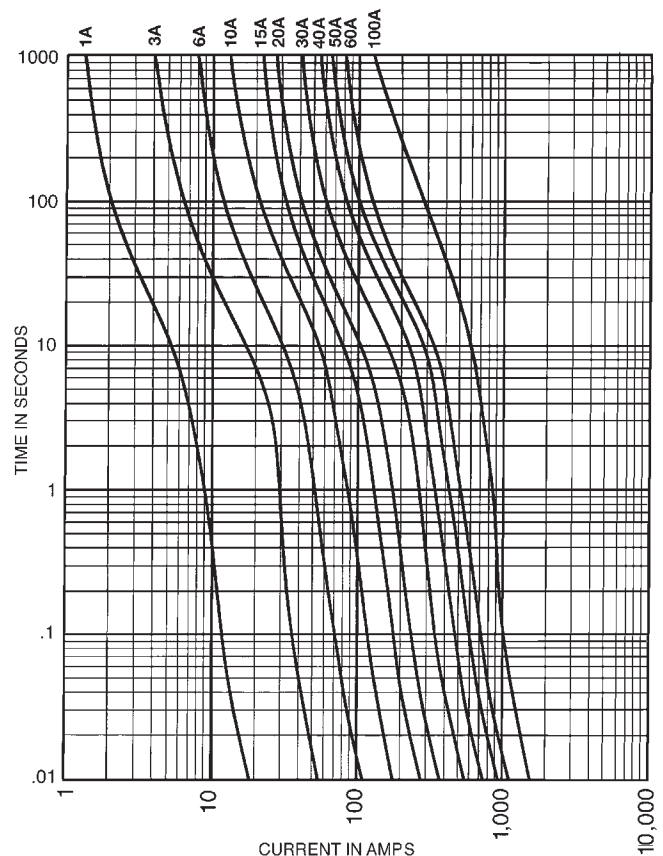

Data Sheet: 9000 (fuses) and 9007 (holders)

# CUBEFuse® Finger-safe Fuse and Fuse Holder System

Low Voltage Branch Circuit Fuses

Dimensions for CUBEFuse® Fuse and Fuse Holder

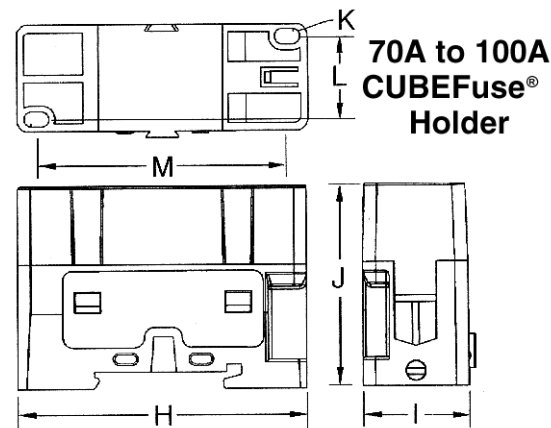
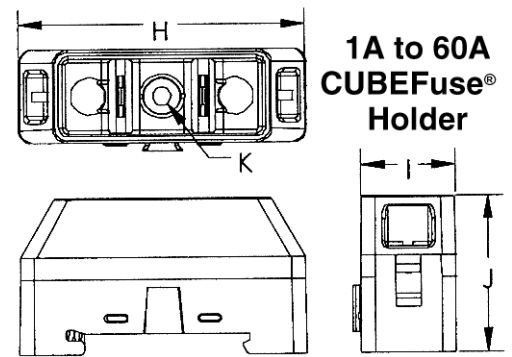
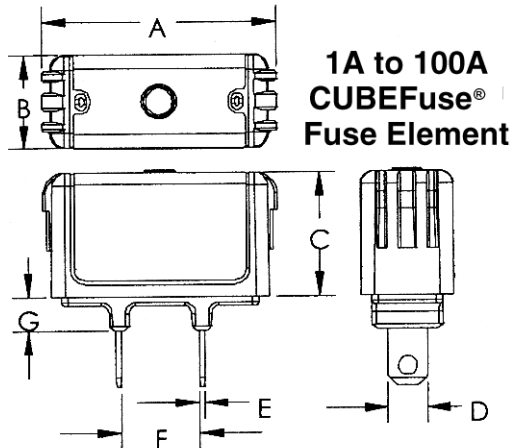

Fuse Amps	Dimensions - in (mm)						
	A	B	C	D	E	F	G
1-15	1.88 (47.75)	0.75 (19.05)	1.00 (25.40)	0.23 (5.84)	0.04 (1.02)	0.63 (15.88)	0.27 (6.86)
17.5-20	1.88 (47.75)	0.75 (19.05)	1.00 (25.40)	0.27 (6.86)	0.04 (1.02)	0.63 (15.88)	0.27 (6.86)
25-30	1.88 (47.75)	0.75 (19.05)	1.00 (25.40)	0.31 (7.94)	0.04 (1.02)	0.63 (15.88)	0.27 (6.86)
35-40	2.13 (54.10)	1.00 (25.40)	1.13 (28.58)	0.36 (9.14)	0.04 (1.02)	0.63 (15.88)	0.38 (9.65)
45-50	2.13 (54.10)	1.00 (25.40)	1.13 (28.58)	0.40 (10.16)	0.04 (1.02)	0.63 (15.88)	0.38 (9.65)
60	2.13 (54.10)	1.00 (25.40)	1.13 (28.58)	0.44 (11.11)	0.04 (1.02)	0.63 (15.88)	0.38 (9.65)
70-100	3.01 (76.45)	1.00 (25.40)	1.26 (32.00)	0.57 (14.4)	0.06 (1.60)	0.63 (15.88)	0.39 (9.93)

Holder	H	I	J	K	L	M
TCFH30N	2.30 (58.50)	0.76 (19.37)	1.357 (34.24)	0.15 (3.76)	-	-
TCFH60N	2.60 (66.12)	1.03 (26.23)	1.60 (40.64)	0.17 (4.34)	-	-
TCFH100N	2.91 (73.81)	1.05 (26.74)	2.01 (50.93)	0.15 (3.81)	0.80 (20.39)	2.51 (63.65)

Current Limitation Curves

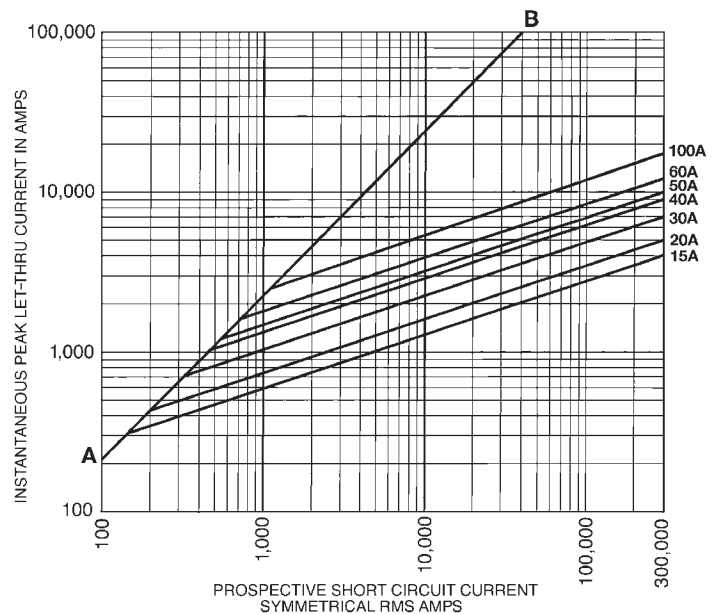

## Time-delay Fuses

### SC Class G

#### Specifications

**Description:** Fast-acting (½-6A), time-delay (7-60A) fuse.

**Dimensions:** See dimensions illustration.

#### Ratings:

- Volts — 600Vac (½-20A)
- 480Vac (25-60A)
- 170Vdc (½-20A)
- 300Vdc (30 & 60A only)

Amps — ½-60A

- IR — 100kA RMS Sym.
- 10kA DC

**Agency Information:** CE, Std. 248-5, Class G, UL Listed, Guide JDDZ, File E4273, CSA Certified, Class 1422-01, File 53787.

#### Features and Benefits

- Current limiting for component protection, providing Class G energy-limitation for branch circuit protection.
- 100kA interrupting rating provides cost-effective branch pcircuit fusing.
- Variations in length help prevent overfusing.

#### Typical Applications

- Fusible Branch Panelboards
- HVAC Branch Circuit Protection



Time-Current Characteristic Curves—Average Melt

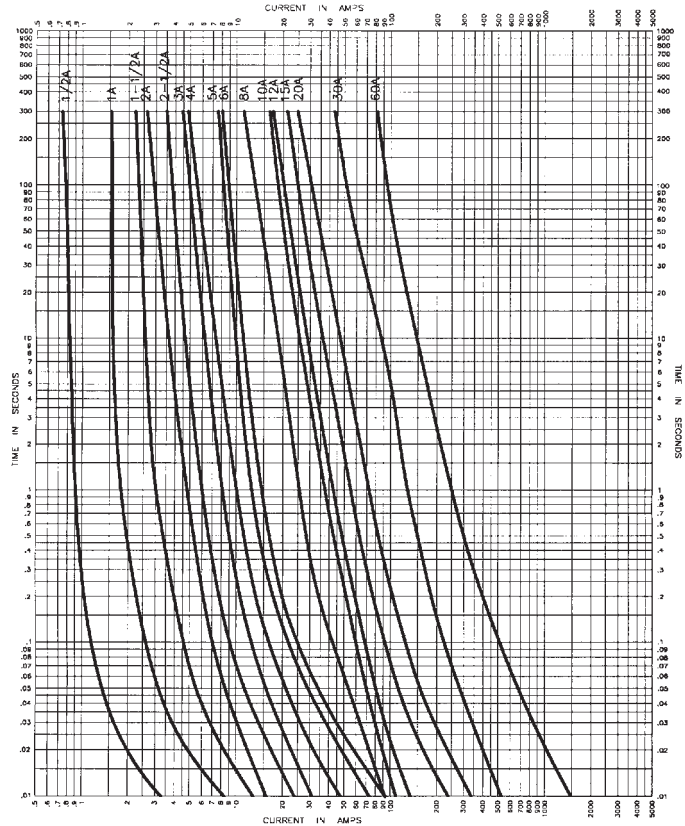

#### Catalog Numbers (Amps)

SC-½	SC-2-½	SC-6	SC-10	SC-25	SC-45
SC-1	SC-3	SC-7	SC-12	SC-30	SC-50
SC-1-½	SC-4	SC-8	SC-15	SC-35	SC-60
SC-2	SC-5	SC-9	SC-20	SC-40	

#### Dimensions -in (mm)

Fuse Amps	Length	Diameter
SC-½ to -15	1.31 (33.3)	0.41" (10.4)
SC-20	1.41 (35.8)	0.41" (10.4)
SC-25 to -30	1.62 (41.2)	0.41" (10.4)
SC-35 to -60	2.25 (57.1)	0.41" (10.4)

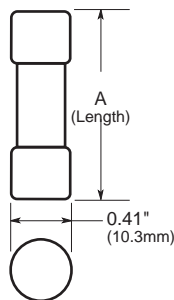

Current Limitation Curves

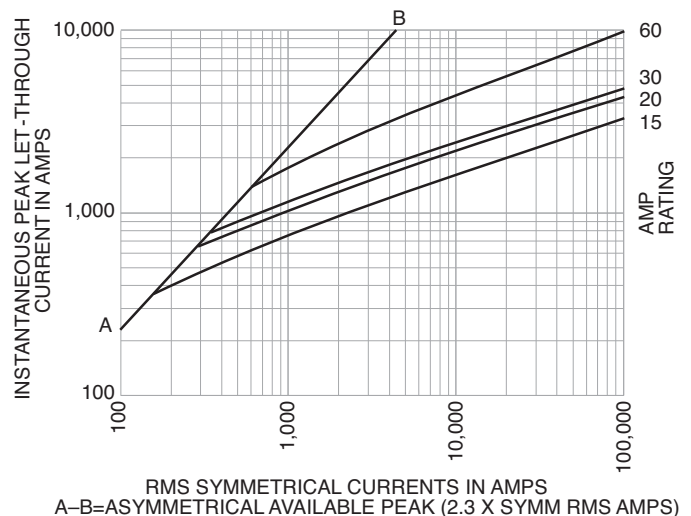

#### Recommended Fuse Holders & Blocks For Class G Fuses

- See page 12

## Low-Peak® Dual-element, Time-delay Fuses

### LPJ\_SP Class J

Available With  
Indication



#### Specifications

##### Description:

Dual-element, time-delay fuse; 10 seconds (minimum) at 500% rated amps. Now available with optional indication on select ratings (see Catalog Numbers table).

**Dimensions:** See page 11 for Class J dimensions.

##### Ratings:

- Volts — 600Vac (or less)
- 300Vdc (or less)
- Amps — 1-600A
- IR — 300kA RMS Sym.
- 100kA dc

**Agency Information:** CE, UL Listed - Special Purpose\*, Guide JFHR, File E56412, CSA Certified (200k AIR) Class J per CSA-22.2 No. 248.8, Class 1422-02, File 53787.

#### Features and Benefits

- Separate overload and short-circuit elements provide time delay for sizing of high inrush loads linked with Class J current limitation.
- Selective coordination ratio of 2:1 (within Low-Peak fuse family) prevents electrical shutdowns from extending beyond the failed circuit.
- Series combination ratings with branch circuit breakers allows broad range of coverage, independent of breaker manufacturer.

#### Typical Applications

- Power Panelboards
- Branch Circuit Breaker Panelboard Mains
- Machinery Disconnects
- Industrial Control

#### Catalog Numbers (Amps)

LPJ-1SP	LPJ-4-½SP	LPJ-25SP**	LPJ-125SP**
LPJ-1-¼SP	LPJ-5SP	LPJ-30SP**	LPJ-150SP**
LPJ-1-⅝SP	LPJ-5-⅝SP	LPJ-35SP**	LPJ-175SP**
LPJ-1-⅞SP	LPJ-6SP**	LPJ-40SP**	LPJ-200SP**
LPJ-2SP	LPJ-7SP**	LPJ-45SP**	LPJ-225SP**
LPJ-2-¼SP	LPJ-8SP**	LPJ-50SP**	LPJ-250SP**
LPJ-2-½SP	LPJ-9SP**	LPJ-60SP**	LPJ-300SP**
LPJ-2-⅝SP	LPJ-10SP**	LPJ-70SP**	LPJ-350SP**
LPJ-3SP	LPJ-12SP**	LPJ-80SP**	LPJ-400SP**
LPJ-3-⅝SP	LPJ-15SP**	LPJ-90SP**	LPJ-450SP**
LPJ-3-¾SP	LPJ-17-½SP**	LPJ-100SP**	LPJ-500SP**
LPJ-4SP	LPJ-20SP**	LPJ-110SP**	LPJ-600SP**

\*Meets all performance requirements of UL Standard 248-8 for Class J fuses.

\*\*Available with optional permanent replace fuse indication. To order, place "I" at end of catalog number. Example: LPJ-6SPI.

Available with silver plated terminals. Add SP/ in front of Catalog Number.

#### Time-Current Characteristic Curves—Average Melt

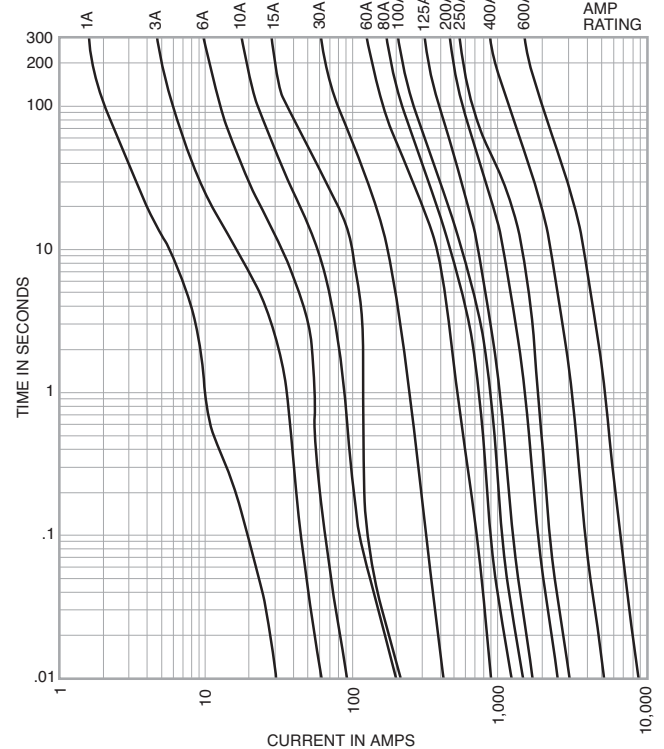

#### Current Limitation Curves

LPJ Current Limitation Curves

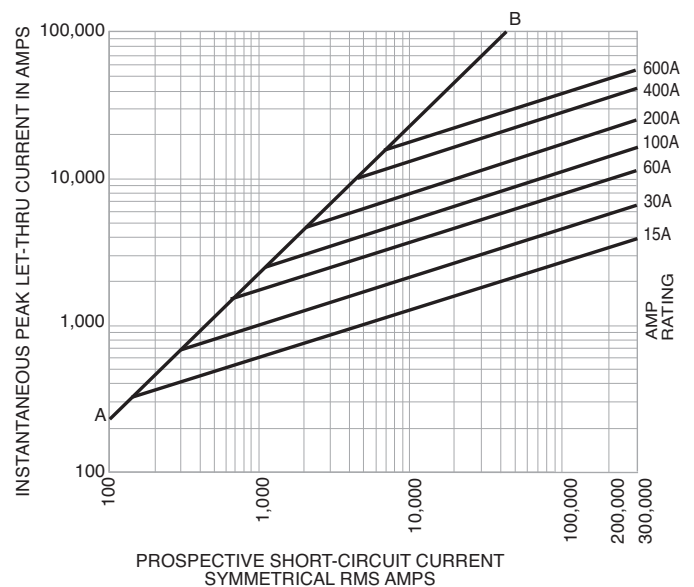

Low Voltage  
Branch  
Circuit  
Fuses

Data Sheets: 1006 (0-60) and 1007 (70-600)  
With indication 1062 (6-60) and 1063 (70-600)

Recommended Fuse Holders & Blocks For Class J Fuses  
• See page 14

## Limitron® Fast-acting Fuses

### JKS Class J



#### Specifications

**Description:** Fast-acting, current-limiting fuse.

**Dimensions:** See page 15 for Class J dimensions.

#### Ratings:

Volts — 600Vac (or less)

Amps — 1-600A

IR — 200kA RMS Sym.

**Agency Information:** CE, Std. 248-8, Class J, UL Listed, Guide JDDZ, File E4273, CSA Certified, Class 1422-02, File 53787.

#### Features and Benefits

- Current limitation for non-inductive circuits provides Class J current-limiting response to maximum ground fault and short-circuit conditions.
- 200kA interrupting rating provides high ratings at all circuit locations.
- Economical solutions for high-fault circuits.

#### Typical Applications

- Power Panelboards
- Machinery Disconnects

#### Catalog Numbers (Amps)

JKS-1	JKS-15	JKS-70	JKS-225
JKS-2	JKS-20	JKS-80	JKS-250
JKS-3	JKS-25	JKS-90	JKS-300
JKS-4	JKS-30	JKS-100	JKS-350
JKS-5	JKS-35	JKS-110	JKS-400
JKS-6	JKS-40	JKS-125	JKS-450
JKS-8	JKS-45	JKS-150	JKS-500
JKS-10	JKS-50	JKS-175	JKS-600
JKS-12	JKS-60	JKS-200	

For superior electrical protection, Cooper Bussmann recommends upgrading JKS fuse applications to Low-Peak LPJ fuses See page 23.

#### Recommended Fuse Holders & Blocks For Class J Fuses

- See page 14

### Time-Current Characteristic Curves—Average Melt

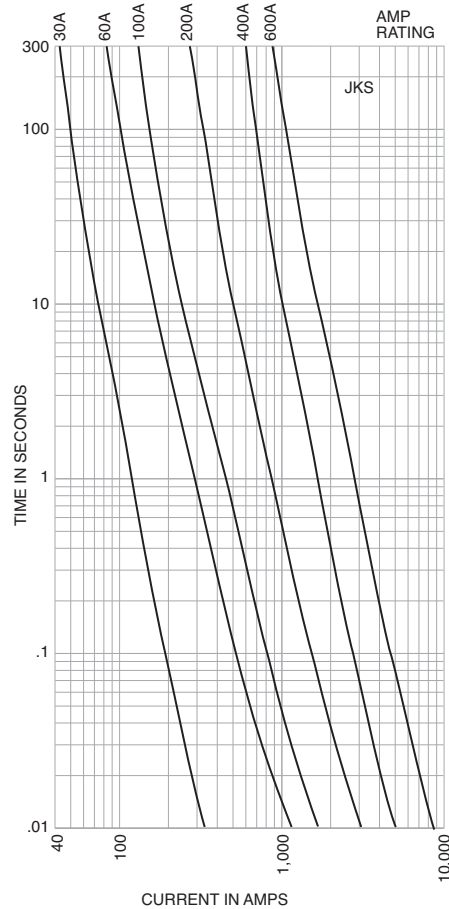

### Current Limitation Curves

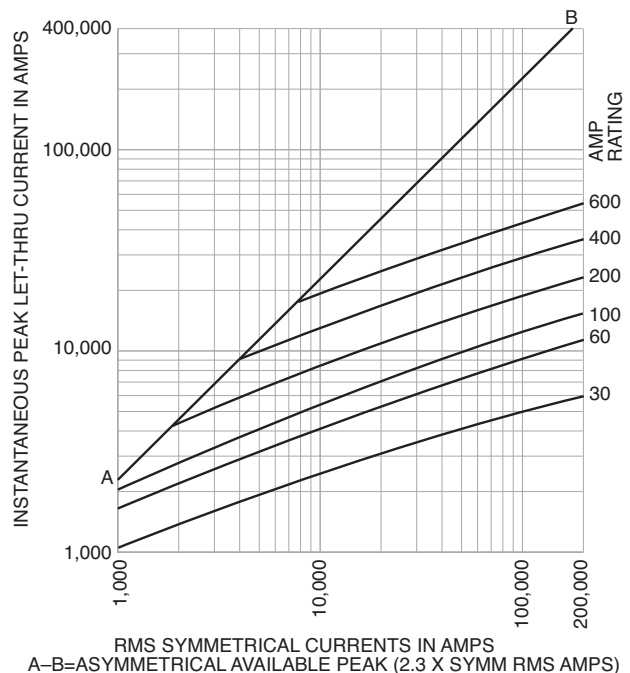

## One-time General Purpose Fuses

Low Voltage  
Branch  
Circuit  
Fuses

### NON (250Vac/125Vdc) Class K5 & H NOS (600Vac) Class K5 & H

#### Specifications

**Description:** General purpose, non-current-limiting fuses.

**Dimensions:** See page 15 for dimensions.

#### Ratings:

- Volts — **NON:**
- 250Vac
  - 125Vdc (0-100A)
- **NOS:**
- 600Vac
- Amps — 1/2-600A
- IR — 50kA RMS Sym. (NON & NOS Class K5 0-60A)
  - 10kA RMS Sym. (NON & NOS Class H65-600A)
  - 50kA @ 125Vdc (NON Class K5 0-60A)
  - 10kA @ 125Vdc (NON Class H 65-100A)



**Agency Information:** CE, UL Listed – 250V: Class K5 (0-60A), Std. 248-9, Class H (65-600A), Std. 248-6, (125Vdc: NON 0-100), 600V: Class K5 (0-60A), Std. 248-9, Class H (70-600A), Std. 248-6, Guide JDDZ, File E4273, CSA Certified – 250V: (0-12, 65-600)†, 600V: (0-600), Class 1421-01, File 53787.

† For CSA Certified 15-60A Ratings, see PON Data Sheet 4126

#### Features and Benefits

- Original fuse providing circuit protection.

#### Typical Applications

- Light Duty Circuit Locations

#### NON (250Vac) Catalog Numbers (Amps)

NON-1/2	NON-5	NON-40	NON-175
NON-1/2	NON-6	NON-45	NON-200
NON-3/4	NON-6-1/2	NON-50	NON-225
NON-1	NON-7	NON-60	NON-250
NON-1	NON-8	NON-65	NON-300
NON-1-1/2	NON-9	NON-70	NON-350
NON-1-1/2	NON-10	NON-75	NON-400
NON-1-3/4	NON-12	NON-80	NON-450
NON-2	NON-15	NON-90	NON-500
NON-2-1/2	NON-20	NON-100	NON-600
NON-3	NON-25	NON-110	
NON-3-3/4	NON-30	NON-125	
NON-4	NON-35	NON-150	

#### NOS (600Vac) Catalog Numbers (Amps)

NOS-1	NOS-12	NOS-70	NOS-200
NOS-2	NOS-15	NOS-75	NOS-225
NOS-3	NOS-20	NOS-80	NOS-250
NOS-4	NOS-25	NOS-90	NOS-300
NOS-5	NOS-30	NOS-100	NOS-350
NOS-6	NOS-35	NOS-110	NOS-400
NOS-7	NOS-40	NOS-125	NOS-450
NOS-8	NOS-45	NOS-150	NOS-500
NOS-9	NOS-50	NOS-175	NOS-600
NOS-10	NOS-60		

#### Recommended Fuse Reducers

250V Fuse Amp Size	Clip Amp Size	Catalog Number (Pair)	600V Fuse Amp Size	Clip Amp Size	Catalog Number (Pair)
30	60	NO.263	30	60	NO.663
30	100	NO.213	30	100	NO.216
60	100	NO.216	60	100	NO.616
60	200	NO.226	60	200	NO.626
100	200	NO.2621	100	200	NO.2621
100	400	NO.2641	100	400	NO.2641
200	400	NO.2642	200	400	NO.2642
100	600	NO.2661	100	600	NO.2661
200	600	NO.2662	200	600	NO.2662
400	600	NO.2664	400	600	NO.2664

For superior electrical protection, Cooper Bussmann recommends upgrading NON (250Vac) and NOS (600Vac) fuse applications to Low-Peak LPN-RK (250Vac) and LPS-RK (600Vac) fuses See page 29.

#### Recommended Fuse Holders & Blocks For Class K5 & H 250V & 600V Fuses

- See page 12

## Low-Peak® Time-delay Fuses

### KRP-C\_SP Class L

#### Specifications

**Description:** Time-delay fuse – 4 seconds (minimum) at 500% rated amps.

**Dimensions:** See page 16 for Class L dimensions.

#### Ratings:

- Volts — 600Vac (or less)
- 300Vdc (601-2000A)
- Amps — 601-6000A
- (use KRP-CL for current ratings under 601A)
- IR — 300kA RMS Sym.
- 100kA DC



#### Catalog Numbers (Amps)

KRP-C-601SP	KRP-C-1000SP	KRP-C-1800SP	KRP-C-3500SP
KRP-C-650SP	KRP-C-1100SP	KRP-C-1900SP	KRP-C-3800SP
KRP-C-700SP	KRP-C-1200SP	KRP-C-2000SP	KRP-C-4000SP
KRP-C-750SP	KRP-C-1350SP	KRP-C-2001SP	KRP-C-4500SP
KRP-C-800SP	KRP-C-1400SP	KRP-C-2400SP	KRP-C-5000SP
KRP-C-801SP	KRP-C-1500SP	KRP-C-2500SP	KRP-C-6000SP
KRP-C-900SP	KRP-C-1600SP	KRP-C-3000SP	

**Agency Information:** CE, UL Listed-Special Purpose (meets all performance requirements of UL Standard 248-10 for Class L fuses), Guide JFHR, File E56412, CSA Certified (200k AIR), Class 1422-02, File 53787, Class L per CSA C22.2, No. 248.10.

#### Features and Benefits

- Time delay of four seconds at five times rating allows closer sizing on large motor loads combined with Class L current limitation.
- Selective coordination ratio of 2:1 (within Low-Peak fuse family) prevents electrical shutdowns from extending beyond the failed circuit.
- Interrupting rating of 300kA RMS symmetrical provides adequate ratings without obsolescence for all electrical systems, big or small.
- Quality construction, using high-grade materials, provides lower watts loss and operating temperatures with superior arc quenching during current-limiting action.

#### Typical Applications

- Large Distribution Switchboards
- Power Panelboards
- Large Machinery Disconnects

**Recommended Fuse Holders & Blocks For Class L Fuses**

- See page 13

## Low-Peak® Time-delay Fuses

Time-Current Characteristic Curves—Average Melt

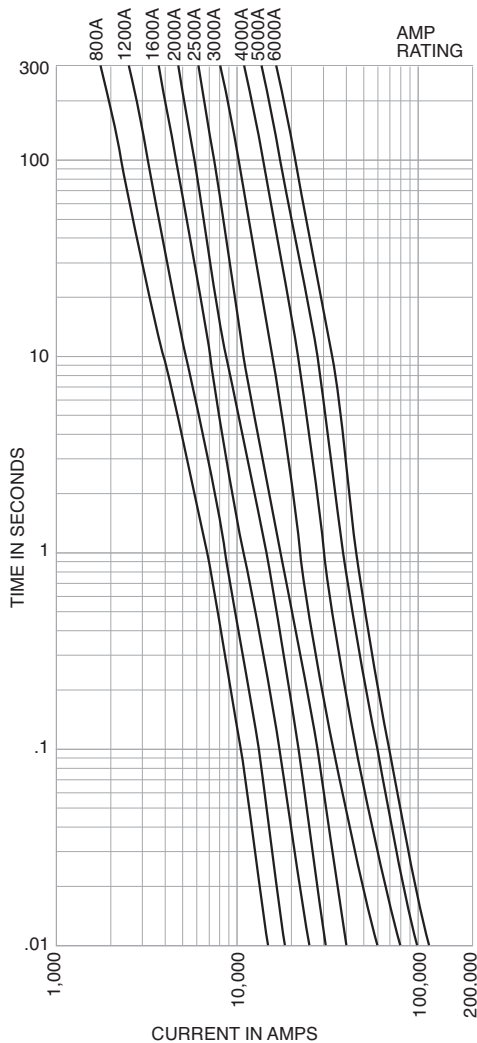

Current Limitation Curves

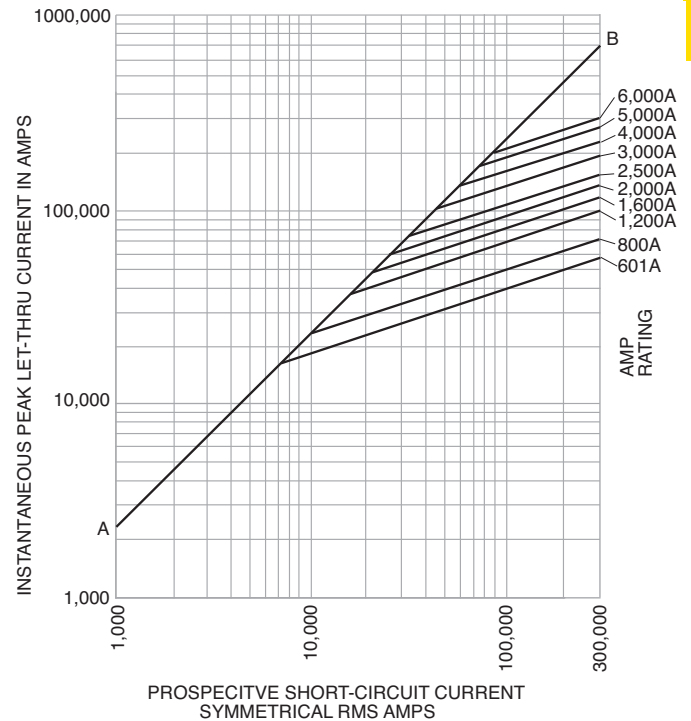

Data Sheets: 1008 and 1009

### KRP-CL Current-limiting, time-delay fuses

#### Specifications

**Description:** Current-limiting, time-delay fuse.

**Dimensions:** See page 16 for Class L dimensions.

#### Ratings:

Volts — 600Vac (or less)

Amps — 150-600A

IR — 200kA RMS Sym.

#### Features and Benefits

- Time-delay of four seconds at five times rating allows closer sizing inductive loads coupled with an equivalent Class L current limitation.

- Class L case size for amp ratings from 150A to 600A allows downsize fusing of large Class L fused switches for improved circuit protection.

#### Typical Applications

- Large Distribution Switchboards
- Power Panelboards
- Machinery Disconnects

#### Catalog Numbers (Amps)

KRP-CL-150	KRP-CL-300	KRP-CL-500
KRP-CL-200	KRP-CL-350	KRP-CL-600
KRP-CL-225	KRP-CL-400	
KRP-CL-250	KRP-CL-450	

#### Recommended Fuse Holders & Blocks For Class L Fuses

- See page 13

Data Sheet: 1016

## Limitron® Fuses

### KTU Class L

#### Specifications

**Description:** Fast-acting, bolt-mount fuse.

**Dimensions:** See page 16 for Class L dimensions.

#### Ratings:

Volts — 600Vac (or less)

Amps — 601-6000A

IR — 200kA RMS Sym.

**Agency Information:** CE, Std. 248-10, Class L, UL Listed, Guide JDDZ, File E4273 CSA Certified, Class 1422-02, File 53787.

#### Features and Benefits

- 200kA interrupting rating provides high ratings at all circuit locations.
- Economical solutions for high-fault circuits.
- Quality construction using high-grade materials provides lower watts loss and operating temperatures with superior arc quenching during current-limiting action.

#### Typical Applications

- Large Distribution Switchboards
- Power Panelboards

#### Catalog Number (Amps)

KTU-601	KTU-1100	KTU-2400
KTU-650	KTU-1200	KTU-2500
KTU-700	KTU-1350	KTU-3000
KTU-750	KTU-1400	KTU-3001
KTU-800	KTU-1500	KTU-4000
KTU-801	KTU-1600	KTU-4500
KTU-900	KTU-1800	KTU-5000
KTU-1000	KTU-2000	KTU-6000



### KLU Class L

#### Specifications

**Description:** Time-delay, bolt-mount fuse - 5 seconds (minimum) at 500% rated amps. See KRP-CL for amp ratings below 601A.

**Dimensions:** See page 16 for Class L dimensions.

#### Ratings:

Volts — 600Vac (or less)

Amps — 601-4000A

IR — 200kA RMS Sym.

**Agency Information:** CE, Std. 248-10, Class L, UL Listed, Guide JDDZ, File E4273, CSA Certified, CSA Class 1422-02, File 53787.

#### Features and Benefits

- 200kA interrupting rating provides high ratings at all circuit locations.
- Economical solutions for high fault circuits.

#### Typical Applications

- Large Distribution Switchboards
- Power Panelboards
- Large Machinery Disconnects

#### Catalog Numbers (Amps)

KLU-601	KLU-1200	KLU-2500
KLU-650	KLU-1500	KLU-3000
KLU-700	KLU-1600	KLU-4000
KLU-800	KLU-1800	
KLU-1000	KLU-2000	



For superior electrical protection, Cooper Bussmann recommends upgrading KTU fuse applications to Low-Peak KRP-C fuses See page 26.

#### Recommended Fuse Holders & Blocks For Class L Fuses

- See page 13

For superior electrical protection, Cooper Bussmann recommends upgrading KLU fuse applications to Low-Peak KRP-C fuses See page 26.

#### Recommended Fuse Holders & Blocks For Class L Fuses

- See page 13

## Low-Peak® Dual-element, Time-delay Fuses

Low Voltage  
Branch  
Circuit  
Fuses

**LPN-RK\_SP (250V) Class RK1**  
**LPS-RK\_SP (600V) Class RK1**

*Available With  
Indication*



**Specifications Description:**  
Current-limiting, dual-element, time-delay fuse; 10 seconds (minimum) at 500% rated amps (8 seconds for 0-30A sizes). Now available with optional indication on select ratings (see Catalog Numbers table).

**Dimensions:** See page 15 for Class RK1 dimensions.

**Ratings:**

Volts **LPN-RK:**

- 250Vac (or less)
- 125Vdc (0-60A)
- 250Vdc (70-600A)

**LPS-RK:**

- 600Vac (or less)
- 300Vdc

Amps — 1/10-600A

- IR — 300kA RMS Sym.
- 100kA DC

**Agency Information:** CE, UL Listed – Special Purpose\*, Guide JFHR, File E56412, CSA Certified (200k AIR), Class RK1 per CSA C22.2, No. 248.12, Class 1422-02, File 53787.

**Features and Benefits**

- Separate overload and short-circuit elements provide time delay for close sizing of high inrush loads linked with RK1 current-limitation and selective coordination ratio of 2:1 (within Low-Peak fuse family) prevents widespread blackouts.
- Inventory consolidation of Class RK1, RK5 and H fuses for reduced SKU investment and minimizing potential for misapplying fuse.
- 300kA RMS symmetrical interrupting rating provides adequate ratings without obsolescence for all electrical systems, big or small.
- Insulated end caps reduces exposure to live parts and extends air gap to distance between blades of adjacent mounted fuses or to housing.

**Typical Applications**

- Large Distribution Switchboards
- Power Panelboards
- Motor Control Centers
- Machinery Disconnect Switches

**LPN Catalog Numbers (Amps)**

LPN-RK-1/10SP	LPN-RK-3-1/2SP	LPN-RK-60SP**
LPN-RK-1/20SP	LPN-RK-4SP	LPN-RK-70SP**
LPN-RK-1/30SP	LPN-RK-4-1/2SP	LPN-RK-80SP**
LPN-RK-1/40SP	LPN-RK-5SP	LPN-RK-90SP**
LPN-RK-1/50SP	LPN-RK-5-1/2SP	LPN-RK-100SP**
LPN-RK-1/60SP	LPN-RK-6SP	LPN-RK-110SP**
LPN-RK-1/70SP	LPN-RK-6-1/2SP	LPN-RK-125SP**
LPN-RK-1/80SP	LPN-RK-8SP	LPN-RK-150SP**
LPN-RK-1SP	LPN-RK-9SP	LPN-RK-175SP**
LPN-RK-1-1/2SP	LPN-RK-10SP	LPN-RK-200SP**
LPN-RK-1-1/4SP	LPN-RK-12SP	LPN-RK-225SP**
LPN-RK-1-1/30SP	LPN-RK-15SP	LPN-RK-250SP**
LPN-RK-1-1/20SP	LPN-RK-17-1/2SP	LPN-RK-300SP**
LPN-RK-1-1/30SP	LPN-RK-20SP	LPN-RK-350SP**
LPN-RK-2SP	LPN-RK-25SP	LPN-RK-400SP**
LPN-RK-2-1/2SP	LPN-RK-30SP	LPN-RK-450SP**
LPN-RK-2-1/4SP	LPN-RK-35SP**	LPN-RK-500SP**
LPN-RK-2-1/30SP	LPN-RK-40SP**	LPN-RK-600SP**
LPN-RK-3SP	LPN-RK-45SP**	
LPN-RK-3-1/2SP	LPN-RK-50SP**	

\*Meets all performance requirements of UL Standard 248-12 for Class RK1 fuses.

\*\*Available with optional indication. To order, place "I" at end of Catalog Number. Example: LPN-RK-35SP-I.

0-60A fuses available with Nickel plate option. (Ex: LPS-RK30SPNP) 70-600A fuses available with Tin plate option. Example: LPS-RK-100SP-TP.

**LPS Catalog Numbers - (Amps)**

LPS-RK-1/10SP	LPS-RK-2-1/2SP	LPS-RK-12SP**	LPS-RK-110SP**
LPS-RK-1/20SP	LPS-RK-2-1/4SP	LPS-RK-15SP**	LPS-RK-125SP**
LPS-RK-1/30SP	LPS-RK-3SP	LPS-RK-17-1/2SP**	LPS-RK-150SP**
LPS-RK-1/40SP	LPS-RK-3-1/2SP	LPS-RK-20SP**	LPS-RK-175SP**
LPS-RK-1/50SP	LPS-RK-3-1/4SP	LPS-RK-25SP**	LPS-RK-200SP**
LPS-RK-1/60SP	LPS-RK-4SP	LPS-RK-30SP**	LPS-RK-225SP**
LPS-RK-1/70SP	LPS-RK-4-1/2SP	LPS-RK-35SP**	LPS-RK-250SP**
LPS-RK-1SP	LPS-RK-5SP	LPS-RK-40SP**	LPS-RK-300SP**
LPS-RK-1-1/2SP	LPS-RK-5-1/2SP	LPS-RK-45SP**	LPS-RK-350SP**
LPS-RK-1-1/4SP	LPS-RK-6SP**	LPS-RK-50SP**	LPS-RK-400SP**
LPS-RK-1-1/30SP	LPS-RK-6-1/2SP**	LPS-RK-60SP**	LPS-RK-450SP**
LPS-RK-1-1/20SP	LPS-RK-7SP**	LPS-RK-70SP**	LPS-RK-500SP**
LPS-RK-1-1/40SP	LPS-RK-8SP**	LPS-RK-80SP**	LPS-RK-600SP**
LPS-RK-1-1/30SP	LPS-RK-9SP**	LPS-RK-90SP**	
LPS-RK-2-1/2SP	LPS-RK-10SP**	LPS-RK-100SP**	

\*Meets all performance requirements of UL Standard 248-12 for Class RK1 fuses.

\*\*Available with optional replace fuse indication. To order, place "I" at end of Catalog Number. Example: LPS-RK-15SP-I.

**Data Sheets:** LPN-RK — 1003 (0-60) and 1004 (70-600)  
LPN-RK with indication — 1066 (70-600)  
LPS-RK — 1001 (0-60) and 1002 (70-600)  
LPS-RK with indication — 1061 (0-60) and 1064 (70-600)

**Recommended Fuse Holders & Blocks For Class RK1 Fuses**

- See page 13

# Low-Peak® Dual-element, Time-delay Fuses

Time-Current Characteristic Curves—Average Melt

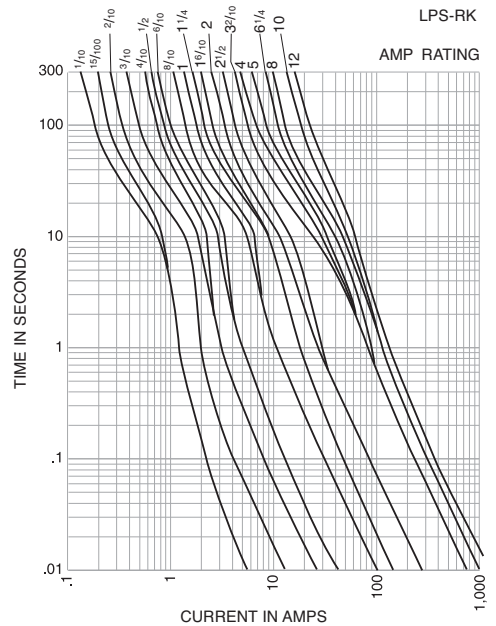
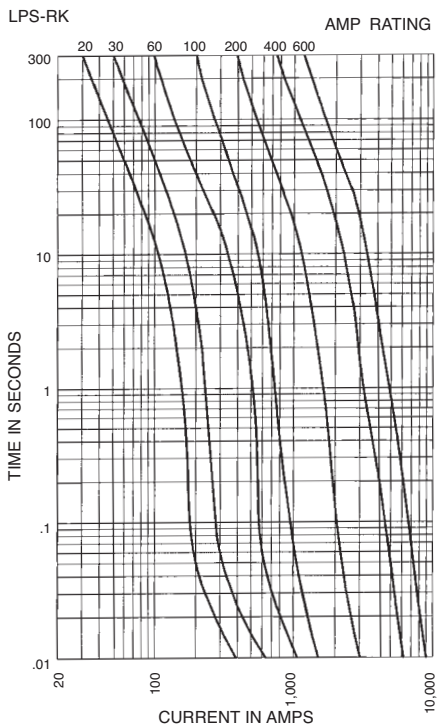
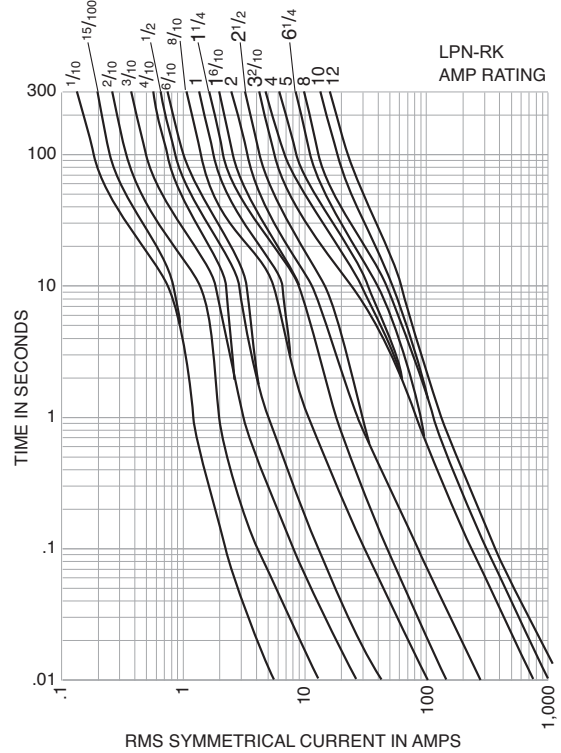
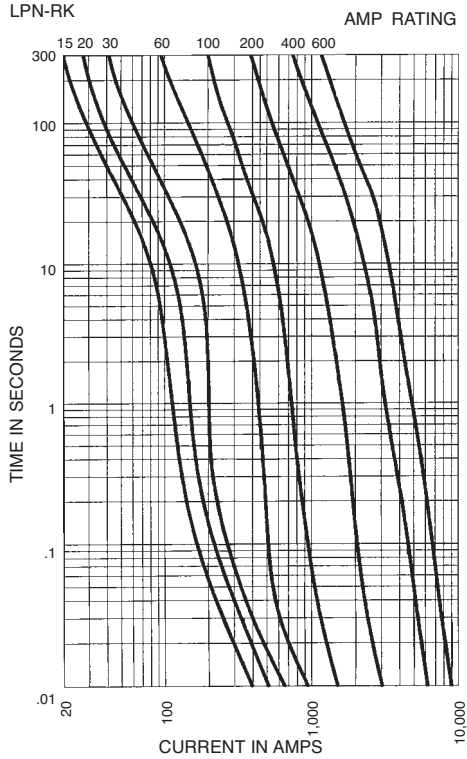

Recommended Fuse Holders & Blocks For Class RK1 Fuses  
 • See page 13

Data Sheets: LPN-RK — 1003 (0-60) and 1004 (70-600)  
 Data Sheets: LPS-RK — 1001 (0-60) and 1002 (70-600)

## Low-Peak® Dual-element, Time-delay Fuses

Low Voltage  
Branch  
Circuit  
Fuses

**Current Limitation Curves—LPN-RK**

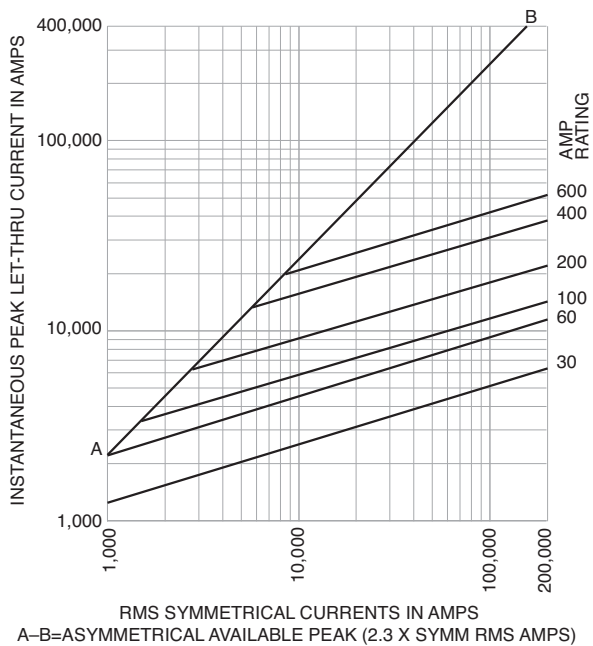

**Current Limitation Curves—LPS-RK**

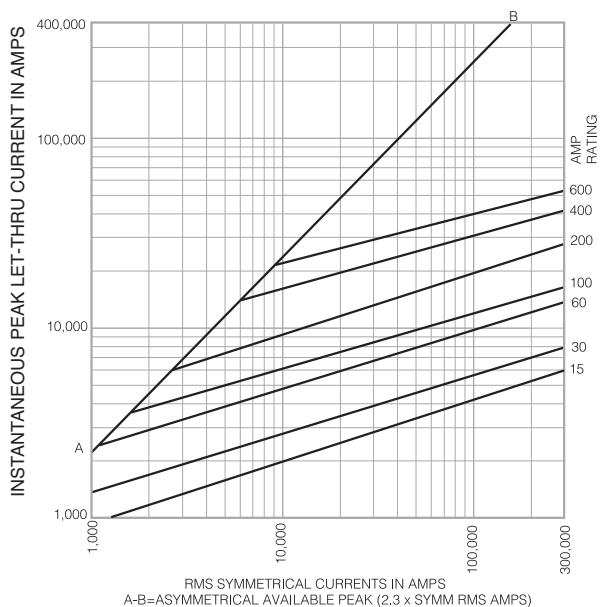

Data Sheets: LPN-RK — 1003 (0-60) and 1004 (70-600)  
Data Sheets: LPS-RK — 1001 (0-60) and 1002 (70-600)

Recommended Fuse Holders & Blocks For Class RK1 Fuses  
• See page 13

## Limitron® Fast-acting Fuses

### KTN-R (250V) Class RK1

#### Specifications

**Description:** Fast-acting, current-limiting fuse.

**Dimensions:** See page 15 for Class RK1 dimensions.

#### Ratings:

- Volts — 250Vac (or less)
- Amps — 1-600A
- IR — 200kA RMS Sym.



**Agency Information:** CE, Std. 248-12, Class RK1, UL Listed, Guide JDDZ, File E54273, CSA Certified, Class 1422-02, File 53787.

#### Features and Benefits

- Current limitation for non-inductive circuits provides Class RK1 current-limiting response to maximum ground fault and short-circuit conditions.
- 200kA interrupting rating provides high ratings at all circuit locations.
- Economical solutions for high-fault circuits.

#### Typical Applications

- Panelboards

#### Catalog Numbers (Amps)

KTN-R-1	KTN-R-30	KTN-R-125
KTN-R-2	KTN-R-35	KTN-R-150
KTN-R-3	KTN-R-40	KTN-R-175
KTN-R-4	KTN-R-45	KTN-R-200
KTN-R-5	KTN-R-50	KTN-R-225
KTN-R-6	KTN-R-60	KTN-R-250
KTN-R-8	KTN-R-70	KTN-R-300
KTN-R-10	KTN-R-75	KTN-R-350
KTN-R-12	KTN-R-80	KTN-R-400
KTN-R-15	KTN-R-90	KTN-R-450
KTN-R-20	KTN-R-100	KTN-R-500
KTN-R-25	KTN-R-110	KTN-R-600

Time-Current Characteristic Curves—Average Melt

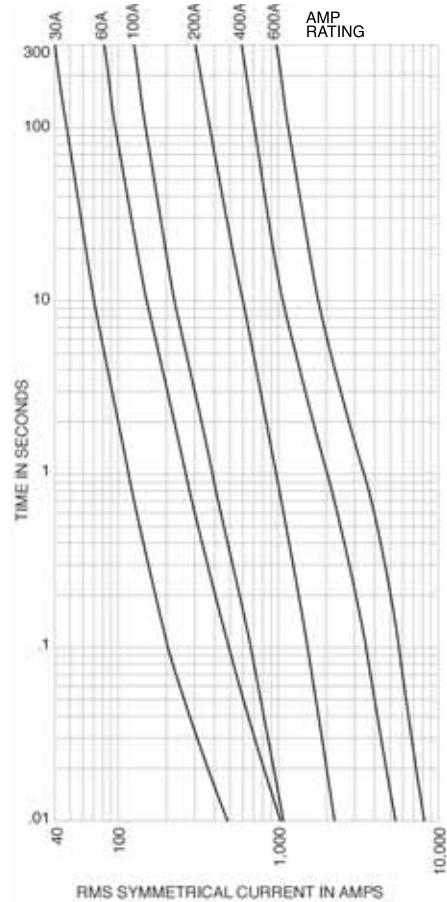

Current Limitation Curves

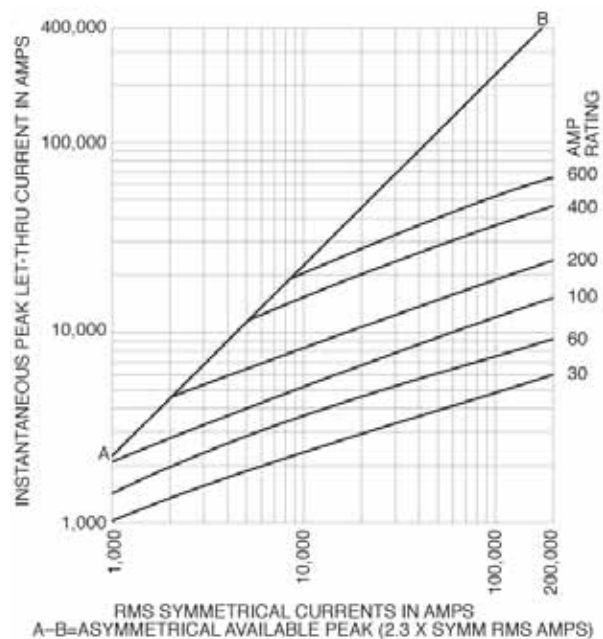

For superior electrical protection, Cooper Bussmann recommends upgrading KTN-R fuse applications to Low-Peak LPN-RK fuses See page 29.

#### Recommended Fuse Holders & Blocks For Class RK1 Fuses

- See page 13

## Limitron® Fast-acting Fuses

### KWS-R (600Vac/dc) Class RK1

#### Specifications

**Description:** Fast-acting, current-limiting fuse.

**Dimensions:** See page 15 for Class RK1 dimensions.

#### Ratings:

Volts — 600Vac (or less); 600Vdc (20-600A)

Amps — 1-600A

IR — 200kA RMS Sym. AC

IR — 100kA DC

**Agency Information:** CE, Std. 248-12, Class RK1, UL Listed, Guide JDDZ, File E54273.



#### Features and Benefits

- Current limitation for non-inductive circuits provides Class RK1 current-limiting response to maximum ground fault an short-circuit conditions.
- 200kA interrupting rating provides high ratings at all circuit locations.
- Economical solutions for applications with high available short-circuit current.

#### Typical Applications

- Photovoltaic systems
- Inverters
- Panelboards

#### Catalog Numbers (Amps)

KWS-R-1	KWS-R-25	KWS-R-125
KWS-R-2	KWS-R-30	KWS-R-150
KWS-R-3	KWS-R-35	KWS-R-175
KWS-R-4	KWS-R-40	KWS-R-200
KWS-R-5	KWS-R-45	KWS-R-225
KWS-R-6	KWS-R-50	KWS-R-250
KWS-R-8	KWS-R-60	KWS-R-300
KWS-R-10	KWS-R-70	KWS-R-350
KWS-R-12	KWS-R-80	KWS-R-400
KWS-R-15	KWS-R-90	KWS-R-500
KWS-R-20	KWS-R-100	KWS-R-600

#### Recommended Fuse Holders & Blocks For Class RK1 Fuses

- See page 13

Time-Current Characteristic Curves—Average Melt

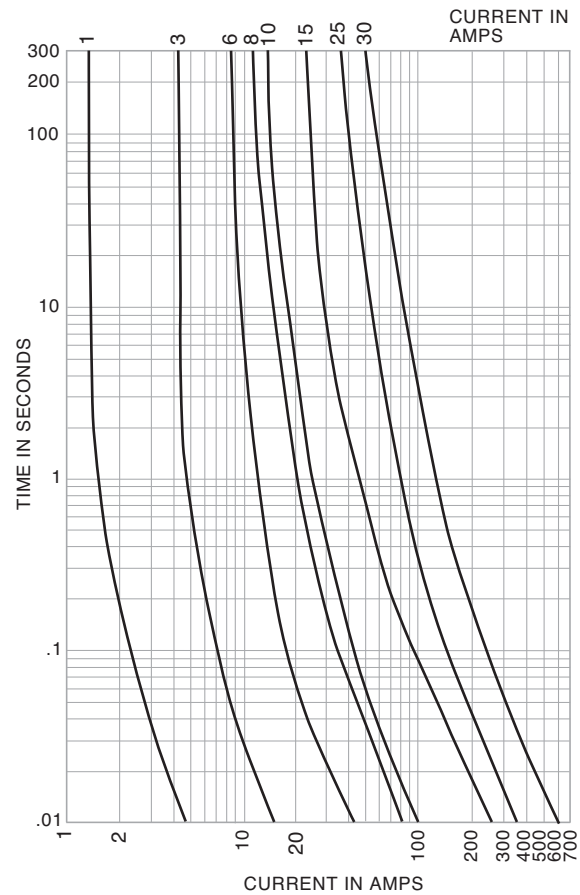

Current Limitation Curves

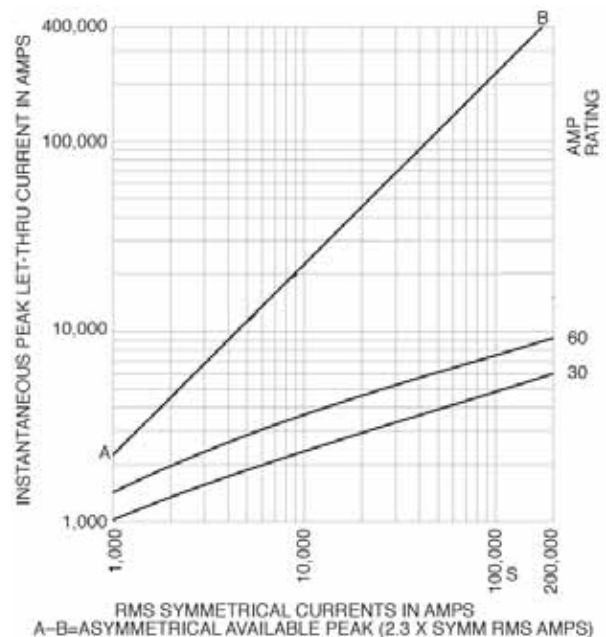

## Dura-Lag™ Dual-element, Time-delay Fuses

### DLN-R (250V) Class RK5

#### Specifications

**Description:** Dual-element, time-delay fuse – 10 seconds (minimum) at 500% rated amps (8 seconds for 0-30A sizes).

**Dimensions:** See page 15 for Class RK5 dimensions.

#### Ratings:

- Volts — 250Vac (or less)
- Amps — 1-600A
- IR — 200kA RMS Sym.
- 20kA DC

**Agency Information:** CE, Std. 248-12, Class RK5, UL Listed, Guide JDDZ, File E4273, CSA Certified, Class 1422-02 File 53787.

#### Features and Benefits

- Separate overload and short-circuit elements provide time delay for close inductive load sizing, linked with RK5 current limitation.
- 200kA interrupting rating provides high ratings at all circuit locations.

#### Typical Applications

- Power Panelboards
- Machinery Disconnects

#### Catalog Numbers (Amps)

DLN-R-1	DLN-R-15	DLN-R-100
DLN-R-2	DLN-R-20	DLN-R-125
DLN-R-2-½	DLN-R-25	DLN-R-150
DLN-R-3	DLN-R-30	DLN-R-175
DLN-R-3-¾	DLN-R-35	DLN-R-200
DLN-R-4	DLN-R-40	DLN-R-225
DLN-R-5	DLN-R-45	DLN-R-250
DLN-R-6	DLN-R-50	DLN-R-300
DLN-R-6-¾	DLN-R-60	DLN-R-400
DLN-R-8	DLN-R-70	DLN-R-600
DLN-R-10	DLN-R-80	
DLN-R-12	DLN-R-90	

For superior electrical protection, Cooper Bussmann recommends upgrading DLN-R fuse applications to Low-Peak LPN-RK fuses See page 29.

#### Recommended Fuse Holders & Blocks For Class RK5 Fuses

- See page 13

Data Sheet: 1021

### DLS-R (600V) Class RK5

#### Specifications

**Description:** Dual-element, time-delay fuse – 10 seconds (minimum) at 500% rated amps.

**Dimensions:** See page 15 for Class RK5 dimensions.

#### Ratings:

- Volts — 600Vac (or less)
- Amps — 1-600A
- IR — 200kA RMS Sym.

**Agency Information:** CE, Std. 248-12, Class RK5, UL Listed, Guide JDDZ, File E4273, CSA Certified, Class 1422-02 File 53787.

#### Features and Benefits

- Separate overload and short-circuit elements provide time delay for close inductive load sizing, linked with RK5 current limitation.
- 200kA interrupting rating provides high ratings at all circuit locations.

#### Typical Applications

- Power Panelboards
- Machinery Disconnects

#### Catalog Numbers (Amps)

DLS-R-1	DLS-R-12	DLS-R-100
DLS-R-1-½	DLS-R-15	DLS-R-110
DLS-R-2	DLS-R-17-½	DLS-R-125
DLS-R-2-½	DLS-R-20	DLS-R-150
DLS-R-3	DLS-R-25	DLS-R-175
DLS-R-3-¾	DLS-R-30	DLS-R-200
DLS-R-4	DLS-R-35	DLS-R-225
DLS-R-5	DLS-R-40	DLS-R-250
DLS-R-6	DLS-R-45	DLS-R-300
DLS-R-6-¾	DLS-R-50	DLS-R-350
DLS-R-7	DLS-R-60	DLS-R-400
DLS-R-8	DLS-R-70	DLS-R-500
DLS-R-9	DLS-R-80	DLS-R-600
DLS-R-10	DLS-R-90	

For superior electrical protection, Cooper Bussmann recommends upgrading DLS-R fuse applications to Low-Peak LPS-RK fuses See page 29.

#### Recommended Fuse Holders & Blocks For Class RK5 Fuses

- See page 13

Data Sheet: 1022

## Fusetron® Dual-element, Time-delay Fuses

### FRN-R (250V) Class RK5

#### Specifications

**Description:** Dual-element, time-delay fuse – 10 seconds (minimum) at 500% rated amps (8 seconds for 0-30A sizes). Available with indication on select ratings (see Catalog Numbers table).

**Dimensions:** See page 15 for Class RK5 dimensions.

#### Ratings:

- Volts — 250Vac (or less)
- 125Vdc ( $\frac{1}{10}$ -60A, 110-200A)
- 250Vdc (225-600A)
- Amps —  $\frac{1}{10}$ -600A
- IR — 200kA RMS Sym.
- 20kA DC



Available With Indication



**Agency Information:** CE, Std. 248-12, Class RK5, UL Listed, Guide JDDZ, File E4273, CSA Certified, Class 1422-01, File 53787.

#### Features and Benefits

- Separate overload and short-circuit elements provide time delay for sizing as close as 125% of motor FLA.
- 2:1 selective coordination amp ratio (within the Cooper Bussmann RK5 fuse family) prevents overcurrent events from opening upstream Fusetron fuses.
- Insulated end caps for 225A-600A fuses reduces exposure to live parts and extends air gap to distance between blades of adjacent mounted fuses or to housing.

#### Typical Applications

- Power Panelboards
- Motor Control Centers
- Combination Starters
- Machinery Disconnects

#### Catalog Numbers (Amps)

FRN-R- $\frac{1}{10}$	FRN-R-2	FRN-R-10*	FRN-R-100
FRN-R- $\frac{1}{8}$	FRN-R-2- $\frac{1}{4}$	FRN-R-12*	FRN-R-110
FRN-R- $\frac{1}{4}$	FRN-R-2- $\frac{1}{2}$	FRN-R-15*	FRN-R-125
FRN-R- $\frac{3}{16}$	FRN-R-2- $\frac{3}{8}$	FRN-R-17- $\frac{1}{2}$ *	FRN-R-150
FRN-R- $\frac{1}{4}$	FRN-R-3	FRN-R-20*	FRN-R-175
FRN-R- $\frac{3}{16}$	FRN-R-3- $\frac{3}{8}$	FRN-R-25*	FRN-R-200
FRN-R- $\frac{1}{4}$	FRN-R-3- $\frac{1}{2}$	FRN-R-30*	FRN-R-225
FRN-R- $\frac{1}{2}$	FRN-R-4	FRN-R-35*	FRN-R-250
FRN-R- $\frac{3}{8}$	FRN-R-4- $\frac{1}{2}$	FRN-R-40*	FRN-R-300
FRN-R- $\frac{1}{2}$	FRN-R-5	FRN-R-45*	FRN-R-350
FRN-R-1	FRN-R-5- $\frac{3}{8}$	FRN-R-50*	FRN-R-400
FRN-R-1- $\frac{1}{8}$	FRN-R-6	FRN-R-60*	FRN-R-450
FRN-R-1- $\frac{1}{4}$	FRN-R-6- $\frac{1}{4}$	FRN-R-70	FRN-R-500
FRN-R-1- $\frac{3}{8}$	FRN-R-7	FRN-R-75	FRN-R-600
FRN-R-1- $\frac{1}{2}$	FRN-R-7- $\frac{1}{2}$	FRN-R-80	
FRN-R-1- $\frac{3}{4}$	FRN-R-8*	FRN-R-85	
FRN-R-1- $\frac{3}{4}$	FRN-R-9*	FRN-R-90	

\*Available with indication. To order, place "ID" at the end of the catalog number.

#### Time-Current Characteristic Curves—Average Melt

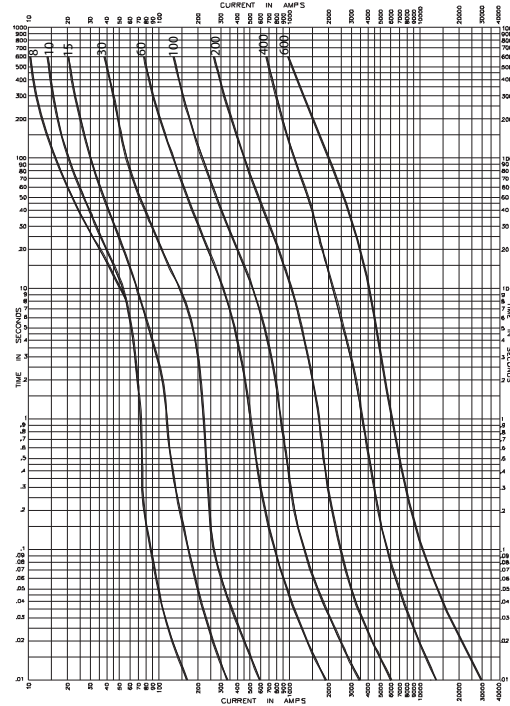

#### Current Limitation Curves

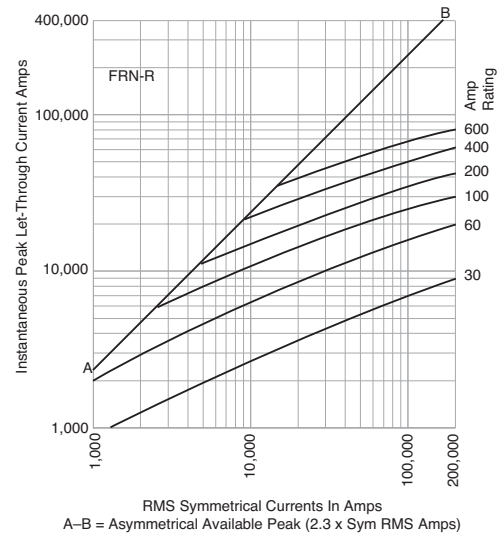

For superior electrical protection, Cooper Bussmann recommends upgrading FRN-R fuse applications to Low-Peak® LPN-RK fuses. See page 29.

#### Recommended Fuse Holders & Blocks For Class RK5 Fuses

- See page 13

#### Recommended Fuse Reducers For Class R Fuses

- See page 14

Data Sheets: 1019 (0-60) and 1020 (70-600)  
Data Sheet: 1169 (8-60) FRN-R with indication

## Fusetron® Dual-element, Time-delay Fuses

### FRS-R (600V) Class RK5

#### Specifications

**Description:** Dual-element, time-delay fuse – 10 seconds (minimum) at 500% rated amps. Now available with optional indication on select ratings (see Catalog Numbers table).

**Dimensions:** See page 15 for Class RK5 dimensions.

#### Ratings:

- Volts — 600Vac (or less)
- 300Vdc
- Amps — 1/10-600A
- IR — 200kA RMS Sym.
- 20kA @ 300Vdc



Available  
With  
Indication



**Agency Information:** CE, Std. 248-12, Class RK5, UL Listed, Guide JDDZ, File E4273, CSA Certified, Class 1422-02, File 53787.

#### Features and Benefits

- 2:1 selective coordination ratio (within RK5 fuse family) prevents electrical shutdowns from extending beyond the failed circuit.
- Insulated end caps for 70-600A fuses reduces exposure to live parts and extends air gap to distance between blades of adjacent mounted fuses or to housing.

#### Typical Applications

- Power Panelboards
- Combination Starters
- Motor Control Centers
- Machinery Disconnects

#### Catalog Numbers (Amps)

FRS-R-1/10	FRS-R-2	FRS-R-10*	FRS-R-100
FRS-R-1/8	FRS-R-2-1/4	FRS-R-12*	FRS-R-110
FRS-R-1/6	FRS-R-2-1/2	FRS-R-15*	FRS-R-125
FRS-R-1/4	FRS-R-2-3/4	FRS-R-17-1/2*	FRS-R-150
FRS-R-3/8	FRS-R-3	FRS-R-20*	FRS-R-175
FRS-R-1/2	FRS-R-3-1/4	FRS-R-25*	FRS-R-200
FRS-R-5/8	FRS-R-3-1/2	FRS-R-30*	FRS-R-225
FRS-R-7/8	FRS-R-4	FRS-R-35*	FRS-R-250
FRS-R-1	FRS-R-4-1/2	FRS-R-40*	FRS-R-300
FRS-R-1-1/8	FRS-R-5	FRS-R-45*	FRS-R-350
FRS-R-1-1/4	FRS-R-5-1/4	FRS-R-50*	FRS-R-400
FRS-R-1-1/2	FRS-R-6*	FRS-R-60*	FRS-R-450
FRS-R-1-3/4	FRS-R-6-1/4*	FRS-R-65	FRS-R-500
FRS-R-1-7/8	FRS-R-7*	FRS-R-70	FRS-R-600
FRS-R-1-9/8	FRS-R-7-1/2*	FRS-R-75	
FRS-R-1-11/8	FRS-R-8*	FRS-R-80	
FRS-R-1-13/8	FRS-R-9*	FRS-R-90	

\*Available with indication. To order, place "ID" at the end of the catalog number. Example: FRS-R-7ID.

For superior electrical protection, Cooper Bussmann recommends upgrading FRS-R fuse applications to Low-Peak LPS-RK fuses. See page 29.

**Data Sheet: 1017 (0-60), 1018 (70-600)**  
**Data Sheet: 1070 (6-60) FRS-R with Indication**

#### Time-Current Characteristic Curves—Average Melt

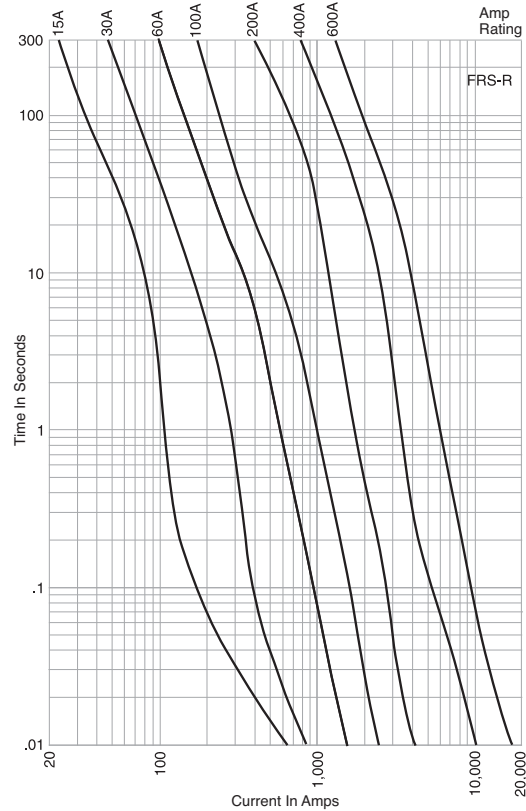

#### Current Limitation Curves

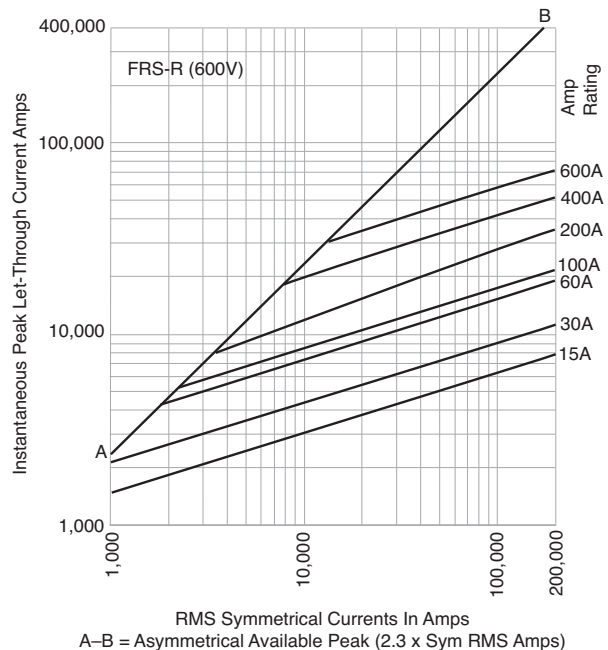

#### Recommended Fuse Holders & Blocks For Class RK5 Fuses

- See page 13

#### Recommended Fuse Reducers For Class R Fuses

- See page 14

## Limitron® Fast-acting Fuses

### PVS-R (600Vac/dc) Class RK5

#### Specifications

**Description:** Fast-acting, current-limiting fuse, designed for the protection of both AC and DC systems.

**Dimensions:** See page 15 for Class RK5 dimensions.

#### Ratings:

- Volts — 600Vac/dc
- Amps — 20-600A
- IR — 200kA RMS Sym. AC
- 100kA DC

**Agency Information:** CE, Std. 248-12, Class RK5, UL Listed, Guide JDDZ, File E4273.

#### Features and Benefits

- Current limitation for non-inductive circuits provides Class RK5 current-limiting response to ground fault and short-circuit conditions.
- Designed for the protection and isolation of photovoltaic systems.

#### Typical Applications

- Photovoltaic systems
- Inverters

#### Catalog Numbers (Amps)

PVS-R-20	PVS-R-70	PVS-R-225
PVS-R-25	PVS-R-80	PVS-R-250
PVS-R-30	PVS-R-90	PVS-R-300
PVS-R-35	PVS-R-100	PVS-R-350
PVS-R-40	PVS-R-125	PVS-R-400
PVS-R-45	PVS-R-150	PVS-R-500
PVS-R-50	PVS-R-175	PVS-R-600
PVS-R-60	PVS-R-200	



Designed to meet the new UL Photovoltaic Fuse Standard

Time-Current Characteristic Curves—Average Melt

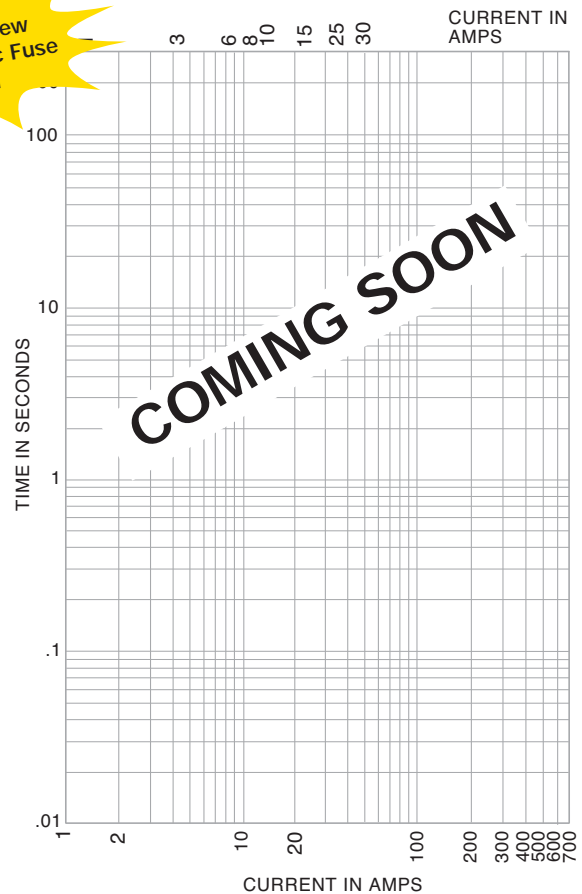

Low Voltage Branch Circuit Fuses

Current Limitation Curves

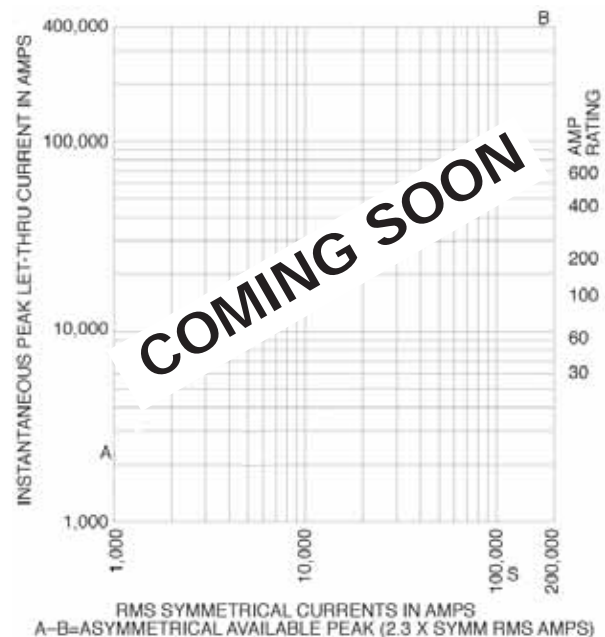

#### Recommended Fuse Holders & Blocks For Class RK5 Fuses

- See page 13

## T-Tron® Fast-acting Fuses

### JJN Class T

#### Specifications

**Description:** Fast-acting, current-limiting fuse.

**Dimensions:** See page 16 for Class T dimensions.

#### Ratings:

- Volts — 300Vac (or less)
- 160Vdc (15-600A)
- 170Vdc (601-1200A)
- Amps — 1-1200A
- IR — 200kA RMS Sym.
- 20kA DC @ 160Vdc
- 100kA DC @ 170Vdc

**Agency Information:** CE, Std. 248-15, Class T, UL Listed, Guide JDDZ, File E4273, CSA Certified, Class 1422-02, File 53787.

#### Features and Benefits

- Series combination ratings with branch circuit breakers allows broad range of coverage, independent of breaker manufacturer.
- Current limitation for non-inductive circuits provides Class T current-limiting response to maximum ground fault and short-circuit conditions.
- 200kA interrupting rating provides high ratings at all circuit locations.
- Small footprint allows more efficient use of available space.

#### Typical Applications

- Large Apartment Complexes
- Multi-Family Meter Stacks
- VFD Line Protection

#### Catalog Numbers (Amps)

JJN-1	JJN-15	JJN-40	JJN-80	JJN-150	JJN-300	JJN-600
JJN-2	JJN-20	JJN-45	JJN-90	JJN-175	JJN-350	JJN-700
JJN-3	JJN-25	JJN-50	JJN-100	JJN-200	JJN-400	JJN-800
JJN-6	JJN-30	JJN-60	JJN-110	JJN-225	JJN-450	JJN-1000
JJN-10	JJN-35	JJN-70	JJN-125	JJN-250	JJN-500	JJN-1200

#### Recommended Fuse Holders & Blocks For Class T Fuses

- See page 13

Data Sheet: 1025



#### Time-Current Characteristic Curves—Average Melt

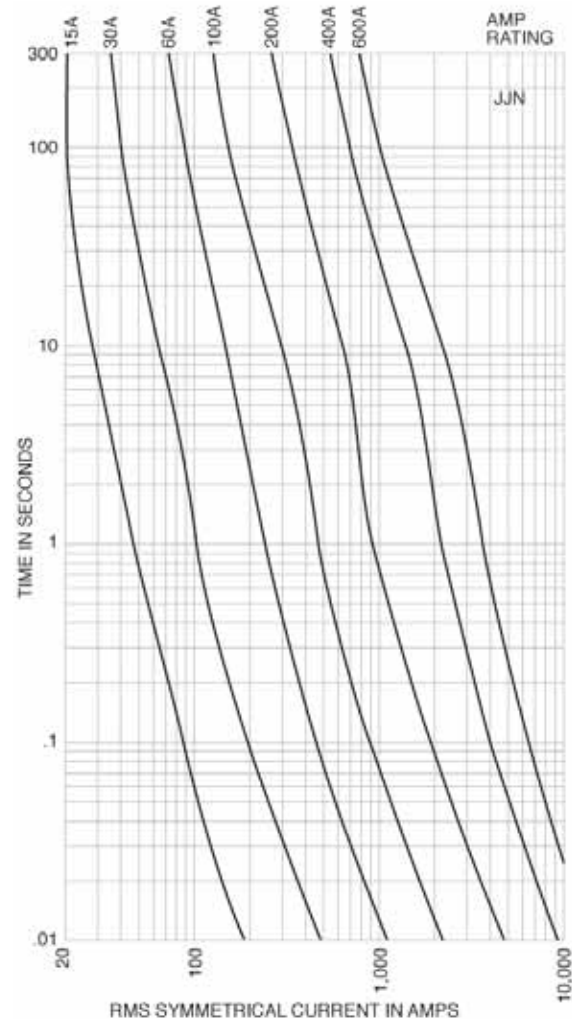

#### Current Limitation Curves

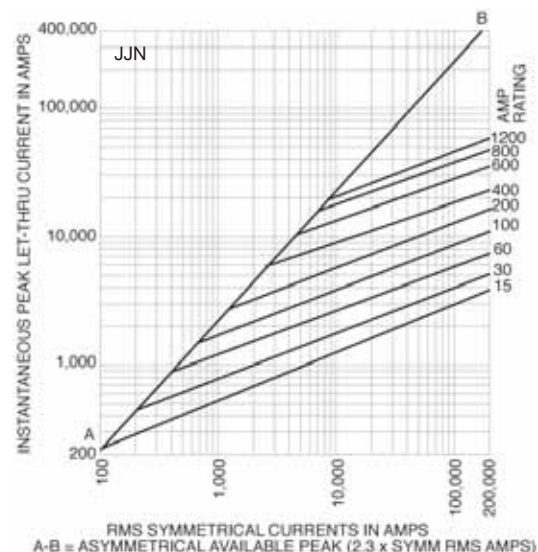

## T-Tron® Fast-acting Fuses

### JJS Class T

#### Specifications

**Description:** Very fast-acting, current-limiting fuse.

**Dimensions:** See page 16 for Class T dimensions.

#### Ratings:

Volts — 600Vac (or less)

Amps — 1-800A

IR — 200kA RMS Sym.

**Agency Information:** CE, Std. 248-15, Class T, UL Listed, Guide JDDZ, File E4273, CSA Certified, Class 1422-02, File 53787.

#### Features and Benefits

- Series combination ratings with branch circuit breakers allows broad range of coverage, independent of breaker manufacturer.
- Current limitation for non-inductive circuits provides Class T current-limiting response to maximum ground fault and short-circuit conditions.
- 200kA interrupting rating provides high ratings at all circuit locations.
- Small footprint allows more efficient use of available space.

#### Typical Applications

- Large Apartment Complexes
- Multi-Family Meter Stacks
- VFD Line Protection

#### Catalog Numbers (Amps)

JJS-1	JJS-15	JJS-40	JJS-80	JJS-150	JJS-300	JJS-600
JJS-2	JJS-20	JJS-45	JJS-90	JJS-175	JJS-350	JJS-800
JJS-3	JJS-25	JJS-50	JJS-100	JJS-200	JJS-400	
JJS-6	JJS-30	JJS-60	JJS-110	JJS-225	JJS-450	
JJS-10	JJS-35	JJS-70	JJS-125	JJS-250	JJS-500	



Time-Current Characteristic Curves—Average Melt

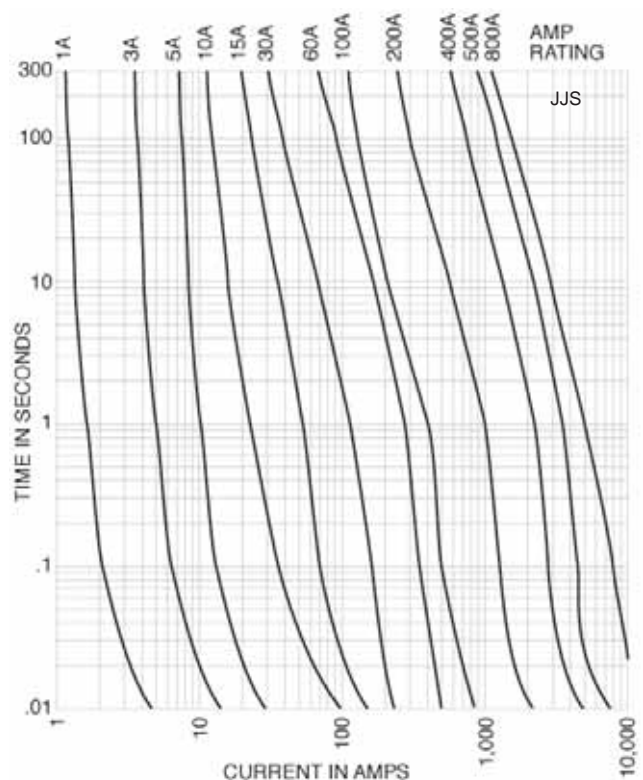

Low Voltage Branch Circuit Fuses

Current Limitation Curves

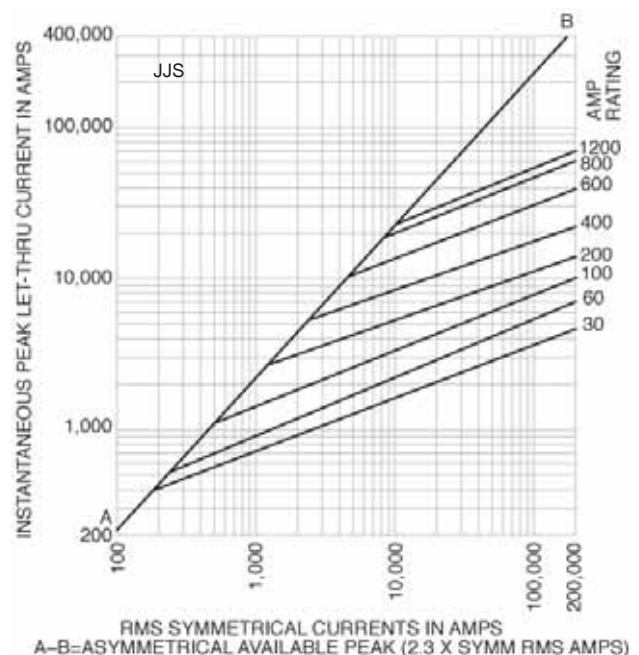

#### Recommended Fuse Holders & Blocks For Class T Fuses

- See page 13

Data Sheet: 1029

## Plug Fuses

### W Series

#### Specifications

**Description:** Fast-acting plug fuse.

**Dimensions:** Edison base plug.

**Construction:** Brass threads with plastic body.

#### Ratings:

Volts — 125Vac

Amps — ½-12A

IR — 10kA RMS Sym.

**Agency Information:** CE, Std. 248-11, UL Listed, Guide JEFV, File E12112.

#### Features and Benefits

- Dependable, fast-acting circuit protection with 10kA interrupting rating for added safety when applied to existing plug fuse systems and 125-volt single-phase control circuits.

#### Typical Applications

- Replacement only in existing systems.
- For general purpose circuit protection.
- Use for lighting and other non-motor circuits.

#### Catalog Numbers\* (Amps)

W-½	W-2 ½	W-6	W-10
W-1	W-3	W-6 ½	W-12
W-1 ⅓	W-4	W-7	W-DUMMY**
W-2	W-5	W-8	

\*W-15, W-20, W-25, and W-30 plug fuses obsoleted. Suggest replacing with either T-(Amp) or TL-(Amp) plug fuses.

\*\* Non-conductive dummy base. Not a fuse.



### SL and TL Series

#### Specifications

**Description:** Time-delay, loaded link plug fuse.

#### Dimensions:

SL — Rejection base

TL — Edison base

#### Construction:

SL — Plastic base with rejection threads

TL — Brass threads with plastic body

#### Ratings:

Volts — 125Vac

Amps — 15-30A

IR — 10kA RMS Sym.

**Agency Information:** CE, Std. 248-11, UL Listed, Guide JEFV, File E12112.

#### Features and Benefits

- Time-delay loaded link TL Series Edison base plug fuses pass motor overload starting currents without opening and allow closer sizing to motor load for added protection.
- Time-delay loaded link SL Series fuses provide a rejection feature (when used alone or with Fustat adapters to retrofit Edison base holders) to help prevent overfusing.

#### Typical Applications

- Small motor and inductive load circuits with high in-rush current levels.
- Used with box cover units to provide equipment protection.
- Applications benefiting from fuse rejection (SL Series only).

#### SL Catalog Numbers (Amps)

SL-15	SL-20	SL-25	SL-30
-------	-------	-------	-------

#### TL Catalog Numbers (Amps)

TL-15	TL-20	TL-25	TL-30
-------	-------	-------	-------

EDA\*\*\* EDN\*\*\*\*

\*\*\* Non-conductive Edison base dummy. Not a fuse.

\*\*\*\* Conductive Edison base dummy. Not a fuse.



Data Sheet: 1036

Recommended Fuse Holders For W Series Plug Fuses

- See page 14

Data Sheets: 1033 (SL) & 1035 (TL)

Recommended Fuse Holders For SL & TL Series Plug Fuses

- See page 14
- See page 42 for Fustat adapters for use with SL Series

## Plug Fuses

Low Voltage  
Branch  
Circuit  
Fuses

### S and T Series

#### Specifications

**Description:** Dual-element, time-delay plug fuse.

#### Dimensions:

- S — Rejection base
- T — Edison base

#### Construction:

- S — Plastic base with rejection threads
- T — Brass threads with plastic body

#### Ratings:

- Volts — 125Vac
- Amps — S Series: ¼-30A
- T Series: ⅓-30A
- IR — 10kA RMS Sym.

**Agency Information:** CE, Std. 248-11, Type S and T; UL Listed (0-6¼) Guide JFHR, File E56412 (7-30A) Guide JEFV, File E12112; CSA Certified, Class 1423-01, File 53787.

#### Features and Benefits

- Time-delay, dual-element T Series Edison base plug fuses provide small motor overload protection when used with box cover units.
- Time-delay, dual-element S Series plug fuses provide a rejection feature (when used alone or with Fustat adapters to retrofit Edison base holders) to prevent overfusing of branch circuits.

#### Typical Applications

- S Series — Residential Load Centers
- T Series — Box Cover Units for small motor overload protection
- Applications benefiting from fuse rejection (S Series only)

#### S Series Catalog Numbers (Amps)

S-¼	S-⅓	S-1-⅓	S-2-½	S-4	S-7	S-14
S-⅓	S-1	S-1-⅓	S-2-⅓	S-4-½	S-8	S-15
S-⅓	S-1-⅓	S-2	S-3	S-5	S-9	S-20
S-½	S-1-¼	S-2-¼	S-3-⅓	S-6	S-10	S-25
S-⅓	S-1-⅓	S-5-⅓	S-3-½	S-6-¼	S-12	S-30

#### T Series Catalog Numbers (Amps)

T-⅓	T-1-⅓	T-2-¼	T-4	T-7	T-15
T-⅓	T-1-¼	T-2-½	T-4-½	T-8	T-20
T-½	T-1-⅓	T-2-⅓	T-5	T-9	T-25
T-⅓	T-1-⅓	T-3	T-5-⅓	T-10	T-30
T-⅓	T-1-⅓	T-3-⅓	T-6	T-12	EDA*
T-1	T-2	T-3-½	T-6-¼	T-14	EDN**

\* Non-conductive Edison base dummy. Not a fuse.  
\*\* Conductive Edison base dummy. Not a fuse.

**Data Sheet: 1032 (S) & 1034 (T)**

#### Recommended Fuse Holders For S & T Series Plug Fuses

- See page 14
- See page 42 for Fustat adapters for use with S Series

### P & TC Series

#### Specifications

#### Description:

P Series - Type P Dual-element fuse  
TC Series - Type D Dual-element, Time-delay fuse

#### Dimensions:

Edison base  
**Construction:** Brass threads with plastic body

#### Ratings:

- Volts — 125Vac or less
- Amps — 15-30A
- IR — 10kA

#### Agency Information:

P Series - CSA Certified  
TC Series - CSA Certified (Class 1423-01, File # 53787)

#### Features and Benefits

##### P Series

- “P” rating for Canadian applications.
- Non-time delay for non-inductive loads

##### TC Series

- “D” rating for Canadian applications
- Heavy duty TC fuses are industrial strength products, featuring dual-element construction.
- This spring loaded design provides superior short-circuit and overload protection.
- The TC fuses have more time-delay than the medium duty fuses in order to better protect industrial motors and residential circuits.

#### Typical Applications

- P Series — Non-inductive loads, residential load centers
- TC Series — Box Cover Units for small motor overload protection

#### P Series Catalog Numbers (Amps)

P-15	P-20	P-25	P-30
------	------	------	------

#### TC Series Catalog Numbers (Amps)

TC-15	TC-20	TC-25	TC-30
-------	-------	-------	-------

**Data Sheet: 1039 (TC Series only)**

#### Recommended Fuse Holders For P & TC Series Plug Fuses

- See page 14
- See page 42 for Fustat adapters for use with S Series

## Plug Fuses

### MB Edison Base Circuit Breakers



#### Specifications

**Description:** Edison base manual reset circuit breakers.

**Dimensions:** Edison base

**Construction:** Brass threads with plastic body

#### Ratings:

Volts — 125Vac only

Amps — 15-20A

IR — 10kA RMS Sym.

**Agency Information:** UL Listed, File E14942

#### Features and Benefits

- Fit standard Edison base fuse receptacles.
- Resettable upon overload event.

#### Typical Applications\*

- Replacing Edison base plug fuses in residential fuse panels.

#### Catalog Numbers\* (Amps)

MB-15

MB-20

\* Not for use in box cover units or for inductive loads.

### Fustat Fuse Adapters



#### Specifications

**Description:** Adapters for using Type S and SL rejection fuses in Edison base fuse sockets.

#### Features and Benefits

- Fustat adapters screw into the “Edison” thread fuse sockets of standard fuse boxes making it easy to retrofit existing fuse installations
- Available in various amp ratings to cover a wide range of rating requirements

#### Typical Applications

- Plug fuse installations where it is desirable to restrict fuse amp ratings

#### Catalog Numbers (Amps)

SA-1*	SA-3- $\frac{3}{4}$ o*	SA-10*
SA-1- $\frac{1}{4}$ o*	SA-4*	SA-15**
SA-1- $\frac{5}{8}$ o*	SA-5*	SA-20**
SA-2*	SA-6- $\frac{1}{4}$ o*	SA-30**
SA-2- $\frac{1}{2}$ o*	SA-8*	

\* Single motor circuits.

\*\* Branch circuits.

#### Fustat® Adapters for Small Motor Protection\*

Adapter	Accepts Fuses
SA-1	S-1 or smaller
SA-1- $\frac{1}{4}$ o	S-1- $\frac{1}{4}$ o or smaller
SA-1- $\frac{5}{8}$ o	S-1- $\frac{5}{8}$ o or smaller
SA-2	S-2 or S-1- $\frac{5}{8}$ o
SA-2- $\frac{1}{2}$ o	S-2- $\frac{1}{2}$ o to S-1- $\frac{5}{8}$ o
SA-3- $\frac{3}{4}$ o	S-3- $\frac{3}{4}$ o to S-1- $\frac{5}{8}$ o
SA-4	S-4 to S-3- $\frac{1}{2}$ o
SA-5	S-5 to S-3- $\frac{1}{2}$ o
SA-6- $\frac{1}{4}$ o	S-6- $\frac{1}{4}$ o to S-3- $\frac{1}{2}$ o
SA-8	S-8 to S-7
SA-10	S-10 to S-7
SA-15	S-15 to S-7
SA-20	S-20
SA-30	S-30 to S-20

\* Both motor running and short-circuit protection.

#### Fustat® Adapters for Branch Circuit Protection

Adapter	Accepts Fuses
SA-15	S-15 to S-7
SA-20	S-20
SA-30	S-25
SA 30	S-30 to S-20