



**UN MUNDO DE CABLES**

# **Cables de Control de Mando**

# **2011**

**Control Cables**

Calidad<sup>®</sup>



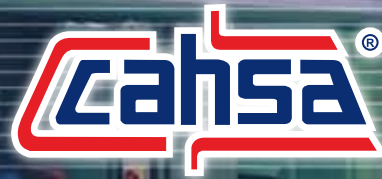

Nuestros cables son **fabricados en México** por mano de obra calificada, 100% mexicana, nuestra experiencia no es solo en el ensamble si no en la manufactura, somos los únicos **expertos**: fabricamos nuestros propios cable, fundas, terminales maquinadas, así como todos los herramientas que se requieren para su desarrollo.

Desde nuestro nacimiento hemos ofrecido al mercado productos de la mejor calidad, servicio y precio. **Nuestra garantía es del 100%**

Utilizamos materia prima de primera calidad y cumplimos con las normas internacionales, lo que nos permite exportar nuestros productos a diferentes partes del mundo.

Por nuestra calidad, servicio, precio y desarrollo constante de nuevos productos nos hacen la mejor opción en el mercado.

Contamos con plantas de manufactura con la mayor experiencia, dedicadas exclusivamente a los cables de control de mando y sus componentes. El personal está altamente calificado, nuestros equipos y maquinaria son los necesarios para desarrollar moldes, extruir e inyectar plásticos, fabricar los diferentes tipos de cable y todas las herramientas que se requieren para tener al mejor precio.

La calidad es 100% garantizada pues contamos con un Laboratorio equipado, único en México que nos ayuda a certificar y comprometernos a que el cable CAHSA que le estamos entregando se mantendrá en funcionamiento.

Es posible mantener los mejores precios cuando el tipo de cambio no es importante, esto solo lo afirmamos porque nuestras ventas a otros países nos permiten tener nuestras finanzas equilibradas.

En CAHSA creemos que el mejor cable no es el más caro, pues cuando cuentas con la infraestructura necesaria puedes dar el mejor producto al mejor precio.

**LA EXCELENCIA EMPIEZA CON LA ACTITUD.**

## **Cables de Mando y Velocímetro /Control and Speedometer Cables**

<b>Índice /index</b>	<b>01-03</b>
<b>Arnes Dual /Arnes Dual</b>	<b>04</b>
<b>Cables de Acelerador /Accelerator Cables</b>	<b>5-45</b>
<b>Cables de Sobremarcha /Detent Cable</b>	<b>45-49</b>
<b>Cables de Embrague /Clutch Cable</b>	<b>50-76</b>
<b>Cables de Velocímetro /Speedometer Cables</b>	<b>77-92</b>
<b>Fundas de Acelerador /Accelerator Sleeves</b>	<b>92</b>
<b>Fundas de Embrague /Clutch Sleeves</b>	<b>93</b>
<b>Frenos de Mano /Brake Cables</b>	<b>93-114</b>
<b>Control de Temperatura /Temperature Control</b>	<b>114</b>
<b>Tirantes de Cofre /Hood Cable</b>	<b>115-123</b>
<b>Ahogadores y Paros de Motor /Choke and Bonet Cables</b>	<b>123-125</b>

<b>Cables Selector de Velocidades /Transhift Cables</b>	<b>126</b>
<b>Cables para Maquinaria /Push Pull Cables</b>	<b>127-128</b>
<b>CHRYSLER</b>	<b>129-134</b>
<b>FORD</b>	<b>135-136</b>
<b>GM</b>	<b>136-145</b>
<b>HYUNDAI</b>	<b>145-146</b>
<b>HONDA</b>	<b>146</b>
<b>KIA MOTORS</b>	<b>146</b>
<b>NAVISTAR</b>	<b>146</b>
<b>NISSAN</b>	<b>147-148</b>
<b>PEUGEOT</b>	<b>148</b>
<b>TOYOTA</b>	<b>148</b>
<b>VOLKSWAGEN</b>	<b>149-150</b>

# Cables de Mando y Velocímetro

Control and Speedometer Cables



## Indice / Index

Serie	100	100	300	400	500	520	600	600	700	900
	Cables de Acelerador	Cables de Sobremarcha	Cables de Embrague	Cables de Velocímetro	Fundas de Acelerador	Fundas de Embrague	Frenos de mano	Control de Temperatura	Tirantes de Cofre	Ahogadores y Paros de Motor
	Accelerator Cables	Detent Cables	Clutch Cables	Speedometer Cables	Accelerator Sleeves	Clutch Sleeves	Brake Cables	Temperature Control	Hood Cable	Choke and Bonet Cables
<b>Chrysler</b>	5	45	50	77			93		115	
<b>Cummins</b>				79						
<b>Daewoo</b>	10		51	79					116	
<b>Daihatsu</b>			52							
<b>Dina</b>	11		52	79					116	
<b>FAMSA</b>	13			80						
<b>Ford</b>	14	46	53	81			95		117	
<b>Fiat</b>	20		54	82			96		117	
<b>General Motors</b>	21	47	54	83			97		118	
<b>Honda</b>			56	83						
<b>Hyundai</b>	26		58	83			101		120	
<b>Isuzu</b>	27		58	84						
<b>Kodiak</b>	27		60							
<b>KIA Motors</b>	27		60	84						
<b>MASA</b>				85						
<b>Mazda</b>	28		61	85			102			
<b>Mitsubishi</b>			61							
<b>Mercedes Benz</b>			63							
<b>Navistar</b>	28						108		120	
<b>Nissan</b>	28	49	63	85			102		121	123
<b>Perkins</b>	34			87						
<b>Peugeot</b>	33		65	87			108		121	
<b>Renault</b>	34		66	88			108			124
<b>Scania</b>	35			88						124
<b>Subaru</b>			67							
<b>Suzuki</b>	36		68	88			109			
<b>Toyota</b>	38		70	89			109		121	
<b>Universales</b>				92			111			124
<b>Vam (Jeep)</b>	39			90						
<b>Volvo</b>			72							
<b>Volkswagen</b>	40		72	90	92	93	111	114	122	
<b>Yugo</b>			76							

# Cables de Mando y Velocímetro

Control and Speedometer Cables



## “La Línea Más Completa” /The Most Complete Line

NOMBRE	ARNÉS DE DUAL
NO. DE PARTE	AD-2533
MÚLTIPLO DE EMPAQUE	25 PIEZAS
PESO	145 GR.
COLOR	NEGRO
LONGITUD	1.35 M (135 MM)
CALIBRE	CALIBRE 3 X 16
CANTIDAD DE CORRIENTE	12V. DE CORRIENTE CONTINUA
LOCALIZACIÓN	EN LA PALANCA, CONECTADO AL BOTÓN DE DUAL
FUNCIÓN	CONDUCTOR DE CORRIENTE, DEL BOTÓN DE DUAL AL MIXTO MOTOR DE DUAL
QUIÉN LO USA	BÁSICAMENTE VEHÍCULOS DE EQUIPO PESADO

## Abreviaciones /Abbreviations

M.	Motor / Motor	STD.	Standard / Standard
Cil.	Cilindros / Cilinder	Carb.	Carburador / Carburator
Trans.	Transmisión / Transmission	ENG.	Encendido / Engine
Aut.	Automático / Automatic		

NUMERO DE PARTE PART NUMBER	NUMERO DE CLIENTE CUSTOMER NUMBER	AÑO / YEAR	VEHICULO / VEHICLE	LONG. A
CH-100	2899336	68-77	ACEL. DART SUPER BEE 8 CIL.	490
CH-101	2843749	67-74	ACEL. CORONET DART GTS 8 CIL.	515
CH-102	2899335	68-75	ACEL. VALIANT DART 6 CIL.	620
CH-103	2465924	67-79	ACEL. PLYMOUTH CORONET 6 CIL.	640
CH-104	3820952	68-77	ACEL. CAMION D100/300 6 CIL.	695
CH-105	2828366	68-74	ACEL. CAMION D600 6 CIL.	810
CH-112	3736610	68-77	ACEL. CAMION D100/300 8 CIL.	640
CH-132	4405061	88-91	ACEL. CAMIONETA D100/300 6 CIL.	700
CH-133	4088095	77-79	ACEL. CAMIONETA D100/300 8 CIL.	620



CH-106	4027354	76-86	ACEL. VALIANT DART 6 CIL.	620
CH-107	4027355	76-86	ACEL. DART SUPER BEE 8 CIL.	505
CH-108	2946700	78-84	ACEL. CAMION D300 6 CIL.	685
CH-109		78-83	ACEL. CAMION D100 D300 8 CIL.	620
CH-110	3733945	75-83	ACEL. CAMION D600 6 CIL.	810
CH-111		75-83	ACEL. CAMION D600 8 CIL.	620
CH-116	3751544	74-77	ACEL. DODGE MONACO 8 CIL.	560
CH-117		79-82	ACEL. DODGE DART 6 CIL.	780
CH-121	4181400		ACEL. MICROBUS	1200



CH-113	4275907	84-86	ACEL. VALIANT DART VOLARE K LARGO	1315
CH-114	4268821	82-83	ACEL. VALIANT DART VOLARE K CORTO	1055



CH-115	2465924	65-67	ACEL. VALIANT DART 6 CIL.	705
--------	---------	-------	---------------------------	-----

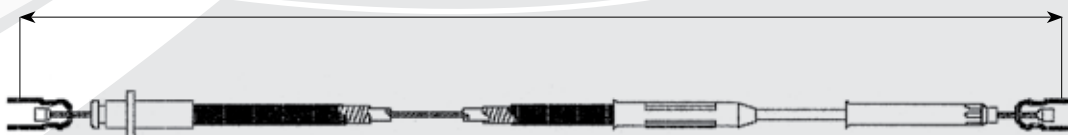

\*Importante: La información indicada en esta publicación, ha sido obtenida por fuentes confiables y oficiales, consideramos que es correcta, sin embargo no asumimos ninguna responsabilidad por errores, cambios, omisiones o daños que resultaran de estos\*.

Cables de Acelerador // Accelerator Cables

NUMERO DE PARTE PART NUMBER	NUMERO DE CLIENTE CUSTOMER NUMBER	AÑO / YEAR	VEHICULO / VEHICLE	LONG. A
CH-118		79-81	ACEL. VALIANT DART	725
CH-123		77-	ACEL. VALIANT DART 6 CIL.	645
CH-124	4027373	76-78	ACEL. VALIANT DART AUTOMATICO	520
CH-125	4027358	76-78	ACEL. DODGE DART 8 CIL.	495
CH-126	4104277		ACEL. CAMIONETA D100/300 8 CIL.	665
CH-127	3828366	75-85	ACEL. CAMION D600 PANEL D300 8 CIL.	705
CH-130	4275940	84-88	ACEL. CAMIONETA D300/350 8 CIL.	695
CH-131	4275939	84-88	ACEL. CAMIONETA D100/150 6 CIL.	720



CH-119	2960213	74-79	ACEL. VANETTE D300 8 CIL.	1320
--------	---------	-------	---------------------------	------



CH-120	4686792	79-84	ACEL. VANETTE D100/300	1310
--------	---------	-------	------------------------	------

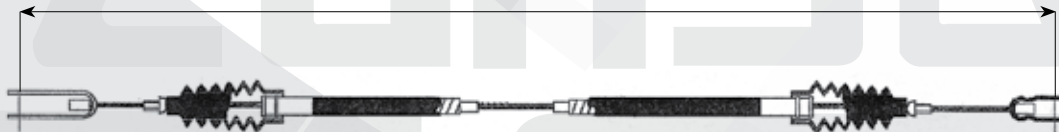

CH-122		87-90	ACEL. PHANTOM 4 CIL.	1240
--------	--	-------	----------------------	------



CH-128	4287531	84-86	ACEL. LEBARON NEW YORKER MAGNUM K	1315
--------	---------	-------	-----------------------------------	------

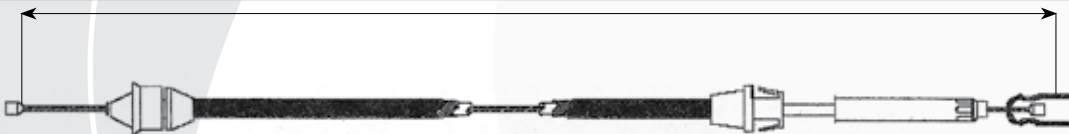

Importante: La información indicada en esta publicación, ha sido obtenida por fuentes confiables y oficiales, consideramos que es correcta, sin embargo no asumimos ninguna responsabilidad por errores, cambios, omisiones o daños que resulten de estos.

NUMERO DE PARTE PART NUMBER	NUMERO DE CLIENTE CUSTOMER NUMBER	AÑO / YEAR	VEHICULO / VEHICLE	LONG. A
CH-129	4307914	89-	ACEL. SHADOW	1310



CH-134			ACEL. CHRYSLER CORTO	1460
CH-135			ACEL. CHRYSLER LARGO	1860

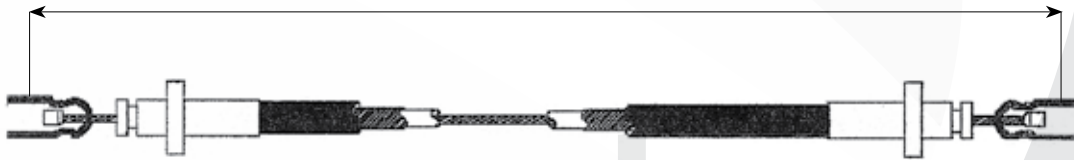

CH-136	4710361	92-93	ACEL. CAMIONETA DODGE D350	670
--------	---------	-------	----------------------------	-----



CH-137	4307914	93	ACEL. MICROBUS DODGE	1315
--------	---------	----	----------------------	------



CH-138	4405061	88-91 Y 93	ACEL. CAMIONETA D150/350 8 CIL.	675
--------	---------	------------	---------------------------------	-----

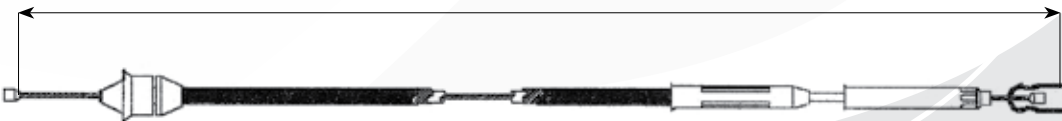

CH-139	5277825	91	ACEL. SPIRIT, SHADOW, PHANTOM AUTOMÁTICO	1187
--------	---------	----	--	------

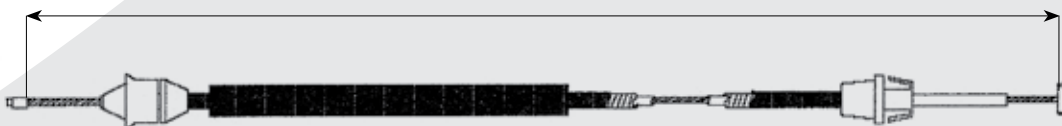

\*Importante: La información indicada en esta publicación, ha sido obtenida por fuentes confiables y oficiales, consideramos que es correcta, sin embargo no asumimos ninguna responsabilidad por errores, cambios, omisiones o daños que resultaran de estos\*.

Cables de Acelerador // Accelerator Cables

NUMERO DE PARTE PART NUMBER	NUMERO DE CLIENTE CUSTOMER NUMBER	AÑO / YEAR	VEHICULO / VEHICLE	LONG. A
CH-140	4710520	94-95	ACEL. RAM 6500	730
CH-141	4729931	94-	ACEL. EXPRESS BUS PHASER	1630

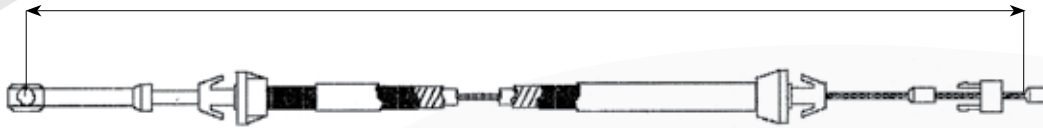

CH-142		87-92	ACEL. MICROBUS	675
--------	--	-------	----------------	-----

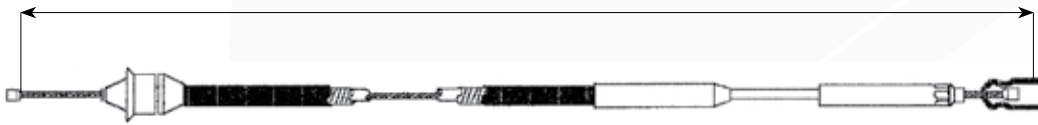

CH-143	4573659	-94	ACEL. NEON	770
CH-156	4669916	95-00	C. ACEL. DODGE STRATUS L4 ECB 2.0L 1996cc(122") FI (C STRATUS L4 ED2 2.4L 2429 cc 148cid STRATUS ES V6 EEB 2.5L 2497 cc 152cid	1558



CH-144	52079351	1997-	ACEL. RAM 1500	1194
--------	----------	-------	----------------	------

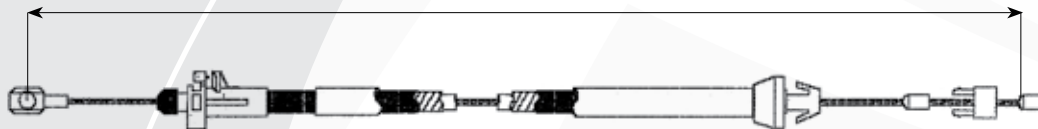

CH-145		1982-	ACEL. MODELOS K TRANS. AUT.	993
--------	--	-------	-----------------------------	-----



Importante: La información indicada en esta publicación, ha sido obtenida por fuentes confiables y oficiales, consideramos que es correcta, sin embargo no asumimos ninguna responsabilidad por errores, cambios, omisiones o daños que resulten de estos.

Cables de Acelerador // Accelerator Cables

NUMERO DE PARTE PART NUMBER	NUMERO DE CLIENTE CUSTOMER NUMBER	AÑO / YEAR	VEHICULO / VEHICLE	LONG. A
CH-147	04300850	93-2000	ACEL. SK TODOS, VOYAGER 1993, SL VOYAGER I-MADERA, SD VOYAGER 2-TONOD, SY VOYAGER TOWN COUNTRY & SM VOYAGER SPORT	1277

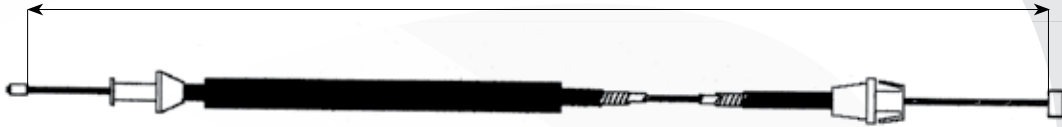

CH-151	53031556AB	81-	ACEL. DURANGO XLT 4X4	1270
--------	------------	-----	-----------------------	------

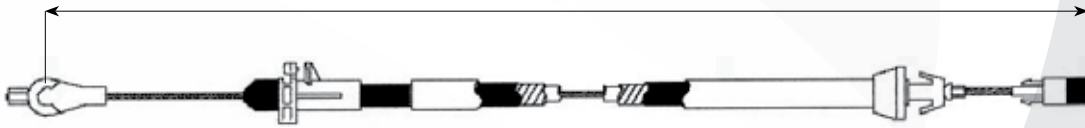

CH-152		90-	ACEL. CARAVAN (IMPORTADA)	1215
--------	--	-----	---------------------------	------



CH-154	53031563	95-98	ACEL. RAM VAN, RAM WAGON 3.9 L	1058.0
--------	----------	-------	--------------------------------	--------



CH157	04891642AA	02-07	C. ACELERADOR PT CRUISER AUTOMATICO	1288
-------	------------	-------	-------------------------------------	------

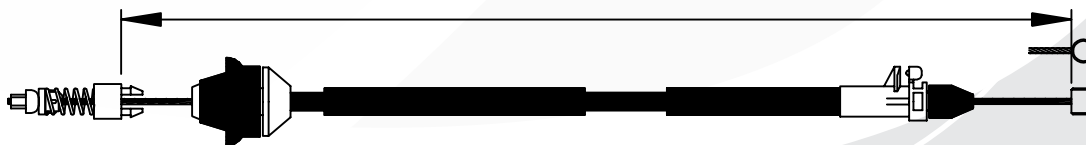

CH158	04891469AA	02-07	C. ACELERADOR PT CRUISER TURBO STANDARD	1583
-------	------------	-------	---	------

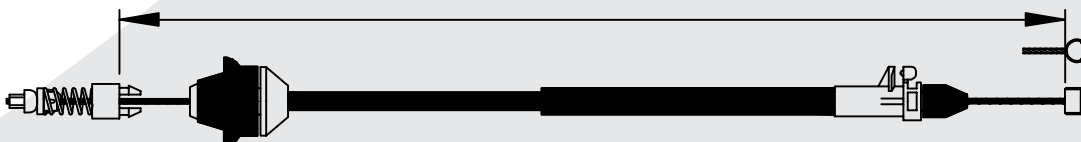

\*Importante: La información indicada en esta publicación, ha sido obtenida por fuentes confiables y oficiales, consideramos que es correcta, sin embargo no asumimos ninguna responsabilidad por errores, cambios, omisiones o daños que resultaran de estos\*.

NUMERO DE PARTE PART NUMBER	NUMERO DE CLIENTE CUSTOMER NUMBER	AÑO / YEAR	VEHICULO / VEHICLE	LONG. A
CH159	04891800AD	02-07	C. ACELERADOR PT CRUISER STANDARD (NO TURBO)	1585

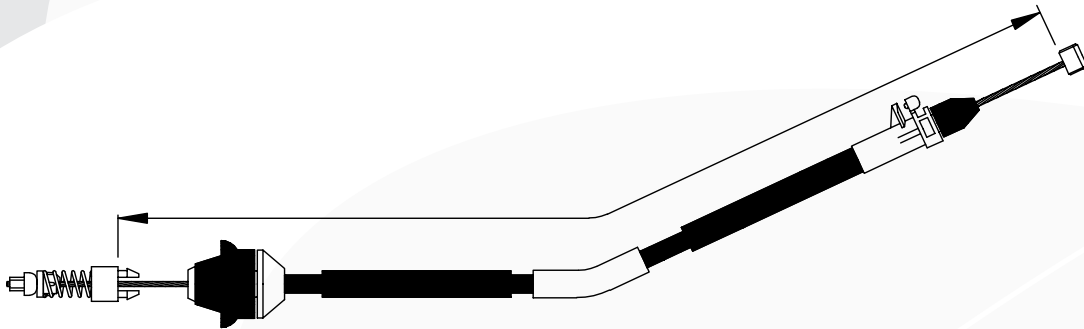

HY-104	3279002010	2000-	ACEL. HYUNDAI ATOS MOTOR 1.1 (5071175AA)	720
--------	------------	-------	--	-----

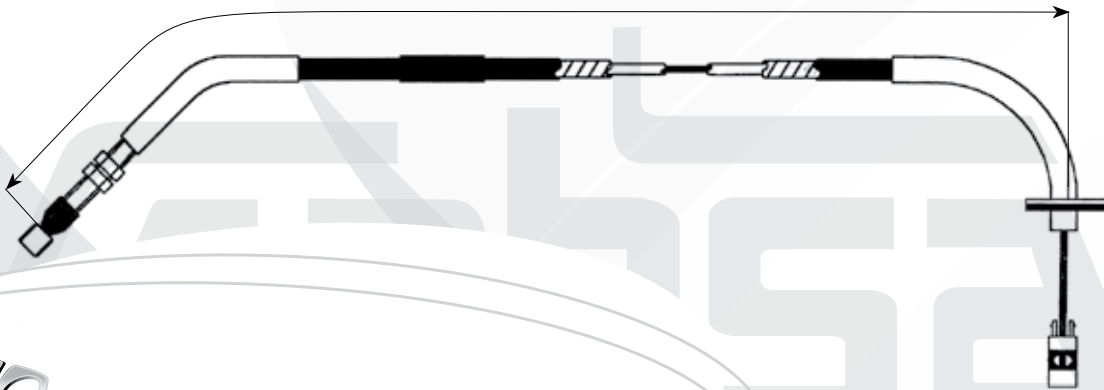

**GM DAEWOO**  
A General Motors Company

NUMERO DE PARTE PART NUMBER	NUMERO DE CLIENTE CUSTOMER NUMBER	AÑO / YEAR	VEHICULO / VEHICLE	LONG. A
DW-100	1P96117394		ACEL. DAEWOO	722



DW-101	96288183	04-	ACEL. PONTIAC MATIZ MOTOR DAEWOO 1.0L MFI 4 CIL, OHC	1433
--------	----------	-----	--	------



DW-102	96490240	2006	C.ACELERADOR PONTIAC MATIZ	1510
--------	----------	------	----------------------------	------

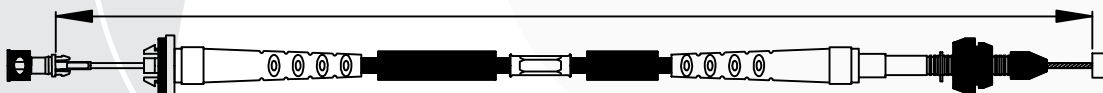

Importante: La información indicada en esta publicación, ha sido obtenida por fuentes confiables y oficiales, consideramos que es correcta, sin embargo no asumimos ninguna responsabilidad por errores, cambios, omisiones o daños que resulten de estos.

NUMERO DE PARTE PART NUMBER	NUMERO DE CLIENTE CUSTOMER NUMBER	AÑO / YEAR	VEHICULO / VEHICLE	LONG. A
DI-100	A5183 A39		ACEL. DINA 531 FUNDA CORTA	815
DI-101	A518339		ACEL. DINA 531/631 FUNDA LARGA	815

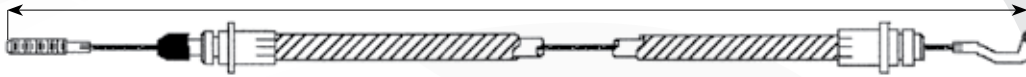

DI-102	A5183E39		ACEL. DINA 604 DELFIN L	1065
--------	----------	--	-------------------------	------

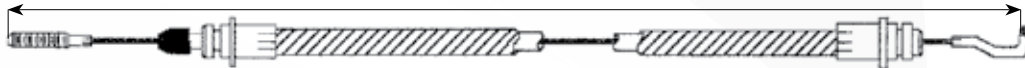

DI-103			ACEL. DINA MOTOR PERKINS CONVENCIONAL CORTO	835
DI-104			ACEL. AUTOBUS URBANO CONVENCIONAL LARGO	1450
DI-107			ACEL. CAMION URBANO 5121	1195
DI-110			ACEL. DINA	1460
DI-119		1991	ACEL. MICROBUS MOTOR DODGE 360 V-8	1570
DI-120			ACEL. CAMION DINA BUFALO	900



DI-108			ACEL. TRACTOCAMION S-861 AUTOBUS Y CAMION MOTOR TRASERO 533/631 6 Y 8 CIL.	1460
DI-115			ACEL. DINA	1470
DI-116			ACEL. DINA 3000 MICROBUS MOTOR PERKINS	1480
DI-118			ACEL. MICROBUS DODGE MOTOR PERKINS	2280



DI-109	2020182	81-82	ACEL. CAMIONETA D-3200 4 CIL.	600
--------	---------	-------	-------------------------------	-----



DI-111			ACEL. DINA ESPECIAL	1455
--------	--	--	---------------------	------

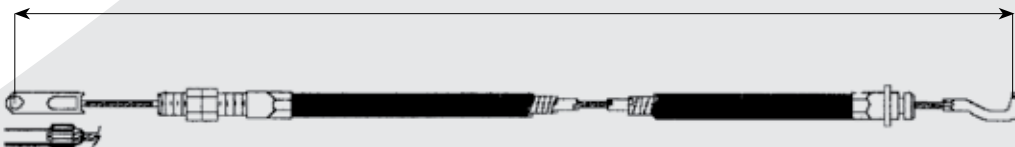

"Importante: La información indicada en esta publicación, ha sido obtenida por fuentes confiables y oficiales, consideramos que es correcta, sin embargo no asumimos ninguna responsabilidad por errores, cambios, omisiones o daños que resultaran de estos".

NUMERO DE PARTE PART NUMBER	NUMERO DE CLIENTE CUSTOMER NUMBER	AÑO / YEAR	VEHICULO / VEHICLE	LONG. A
DI-112		81-82	ACEL. TRACTOCAMION	1725

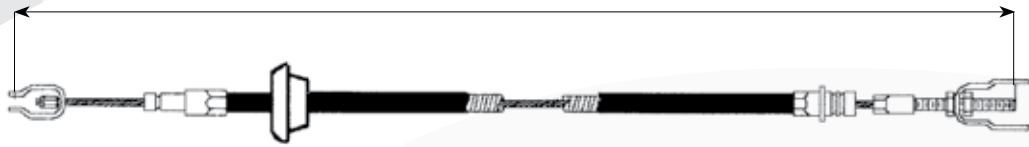

DI-113	2997349C1	90-91	ACEL. DINA 600 6 CIL. STD MOTOR CUMMINS SERIE "C"	510
--------	-----------	-------	---	-----

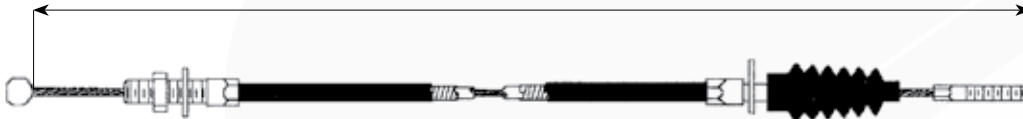

DI-114		90-91	ACEL. CAMION DINA S-400/S-500	890
--------	--	-------	-------------------------------	-----



DI-117	475174C5	91	ACEL. CAMION DINA MOTOR "QSP" NAVISTAR	1080
DI-122		93	ACEL. CAMION DINA NAVISTAR	1460



DI-121	29703261	90-91	ACEL. CAMION DINA S-400/S-500 TUERCA 7/16	890
--------	----------	-------	---	-----



DI-123		92-	ACEL. CAMION A-4	890
--------	--	-----	------------------	-----



Importante: La información indicada en esta publicación, ha sido obtenida por fuentes confiables y oficiales, consideramos que es correcta, sin embargo no asumimos ninguna responsabilidad por errores, cambios, omisiones o daños que resulten de estos.

Cables de Acelerador // Accelerator Cables

NUMERO DE PARTE PART NUMBER	NUMERO DE CLIENTE CUSTOMER NUMBER	AÑO / YEAR	VEHICULO / VEHICLE	LONG. A
DI-124	2998503		ACEL. QSP FASE IV	838



DI-125	MP-101-49-36		ACEL. DINA CABOVER	1977
--------	--------------	--	--------------------	------



DI-126	2993438C91	96-99	ACEL. CAMION DINA, MICROBUS MAQUINA CUMMINS SERIE B160	1045
--------	------------	-------	--	------

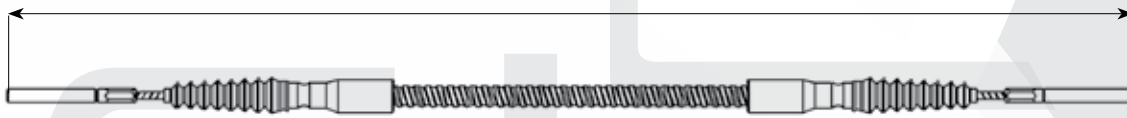

DI-127		TODOS	ACELERADOR CAMION MASA VOLVO C-11	1750
--------	--	-------	-----------------------------------	------



## FAMSA

NUMERO DE PARTE PART NUMBER	NUMERO DE CLIENTE CUSTOMER NUMBER	AÑO / YEAR	VEHICULO / VEHICLE	LONG. A
FA-100	497413091		ACEL. CAMION FAMSA	1020
FA-101	45517202		ACEL. TRACTO CAMION MOTOR INTERNACIONAL	1370

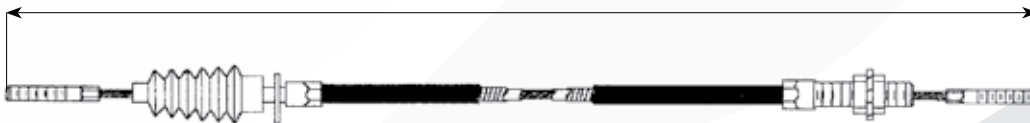

FA-103	497413C91		ACEL. CAMION MERCEDES BENZ FAMSA C250 EN LINEA (TORNILLO Y TOPE)	925
FA-104			ACEL. CAMION CUMMINS, DI600 EN LINEA 4 CIL.	560



"Importante: La información indicada en esta publicación, ha sido obtenida por fuentes confiables y oficiales, consideramos que es correcta, sin embargo no asumimos ninguna responsabilidad por errores, cambios, omisiones o daños que resultaran de estos".

Cables de Acelerador // Accelerator Cables



# Cables de Acelerador / Accelerator Cables



NUMERO DE PARTE PART NUMBER	NUMERO DE CLIENTE CUSTOMER NUMBER	AÑO / YEAR	VEHICULO / VEHICLE	LONG. A
FO-100	CSAZ-9A758-N	65-68	ACEL. GALAXIE	620
FO-101	DOAA-9A758-N	69-70	ACEL. GALAXIE	635



FO-102	DIAZ-9A758-K	71-73	ACEL. GALAXIE	590
FO-106	DIZZ-9A758-H	71-72	ACEL. MUSTANG	560
FO-110	DIDZ-9A758-E	71-73	ACEL. MAVERICK	525

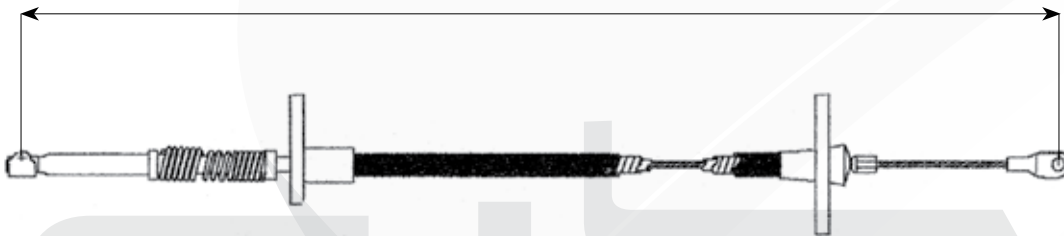

FO-103	D4AZ-9A758-B	74-76	ACEL. GALAXIE	590
FO-104	D7AZ-9A758-A	77-78	ACEL. GALAXIE	565
FO-107	D3ZZ-9A758-C/A	73	ACEL. MUSTANG	575
FO-108	D5ZD-9A758-AA	74-76	ACEL. MUSTANG	600
FO-109	D7ZZ-9A758-C	77-78	ACEL. MUSTANG	610
FO-111	D5DZ-9A758-C	74-77	ACEL. MAVERICK	505
FO-113	D8VD-9A758-AA	78-82	ACEL. FAIRMONT	515
FO-114	E0TD-9A758-AB	79-82	ACEL. F-100/F-150	690
FO-116	D8DZ-9A758-AA	79-84	ACEL. MUSTANG	480

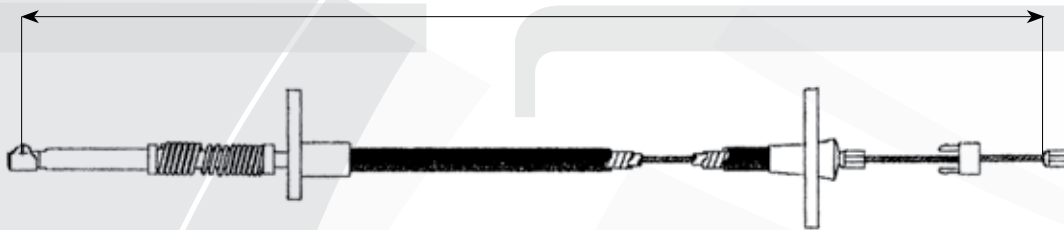

FO-105	C9ZZ-9A758-A	68-69	ACEL. MUSTANG AUTOMATICO	575
--------	--------------	-------	--------------------------	-----

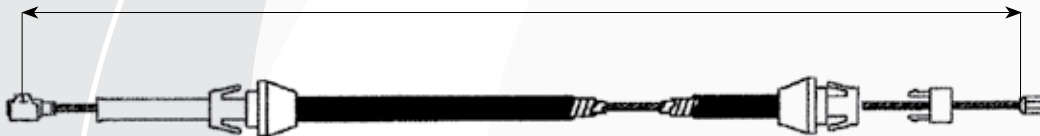

FO-112	Z5TA-9A758-DC	65-73	ACEL. F-100/F-300/F-600	780
FO-118	Z5TA-9A758-A	68-69	ACEL. VANETTE MICROBUS	670



Importante: La información indicada en esta publicación, ha sido obtenida por fuentes confiables y oficiales, consideramos que es correcta, sin embargo no asumimos ninguna responsabilidad por errores, cambios, omisiones o daños que resulten de estos.

Cables de Acelerador / Accelerator Cables

NUMERO DE PARTE PART NUMBER	NUMERO DE CLIENTE CUSTOMER NUMBER	AÑO / YEAR	VEHICULO / VEHICLE	LONG. A
FO-115	E01D9A758-AD/CD	81-86	ACEL. F-100/F-150	700
FO-123		81-86	ACEL. F-100/F-350	545
FO-129		92	ACEL. MICROBUS FORD	1005
FO-138	E4TZ-9A758-D	84-85	ACEL. CAMIONETA SERIES VANS E150-250 V8 460, 351 X8 PICK UP F150-250 -350 & U150 BRONCO WAGON CON 4BBL CARB	575
	E1TZ9A758E	82-83	ACEL. CAMIONETA PICK UP F100-350 V6 232, V8 302 DOBLE CARBURADOR	
	E0TZ9A758B	80-82	ACEL. CAMIONETA PICK UP F100, 350 Y U150 BRONCO WAGON V8 400,351,302,255	

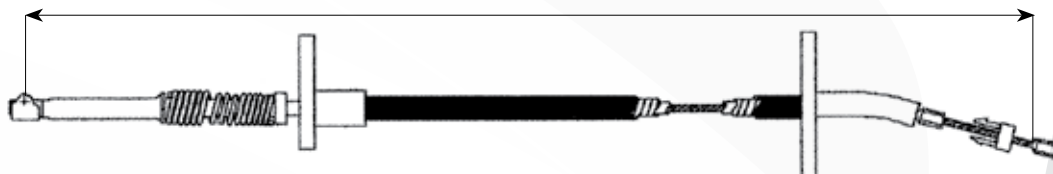

FO-117		-88	ACEL. TOPAZ	450
FO-140		92	ACEL. TOPAZ	555
FO-141		88-92	ACELERADOR RANGER 6CIL. PICK UP/ TOPAZ/GHIA	540
FO-142			ACELERADOR RANGER 4 CIL.	700
FO-143			ACELERADOR RANGER 6 CIL.	960
FO148		91-93	ACELERADOR TOPAZ FUEL INJECTION	620

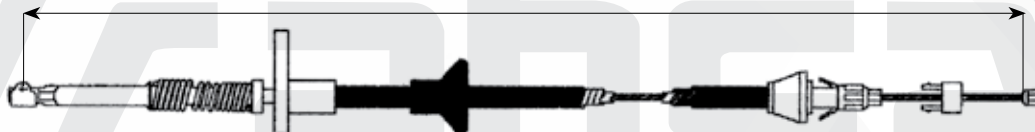

FO-119		70-74	ACEL. VANETTE MICROBUS	1520
--------	--	-------	------------------------	------

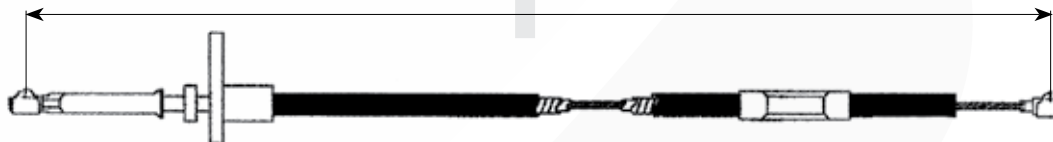

FO-120			ACEL. MICROBUS CORTO F-200	1015
FO-121	E0AZ-9A758-A	79-84	ACEL. CROWN VICTORIA, LTD GRAND MARQUIS	570
FO-122			ACEL. FORD VANETTE MICROBUS LARGO	1740
FO-124		85	ACEL. FORD COUGAR/THUNDERBIRD 6 CIL	480
FO-127		91	ACEL. MICROBUS FORD	1290

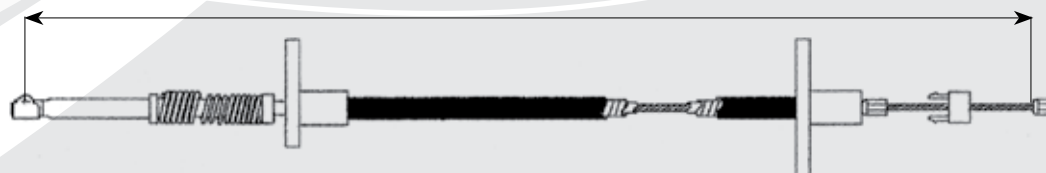

\*Importante: La información indicada en esta publicación, ha sido obtenida por fuentes confiables y oficiales, consideramos que es correcta, sin embargo no asumimos ninguna responsabilidad por errores, cambios, omisiones o daños que resultaran de estos.\*



# Cables de Acelerador / Accelerator Cables



NUMERO DE PARTE PART NUMBER	NUMERO DE CLIENTE CUSTOMER NUMBER	AÑO / YEAR	VEHICULO / VEHICLE	LONG. A
FO-125	76TY-9A758-AA	76-81	ACEL. VANETTE P-350/P-400 8 CIL.	975

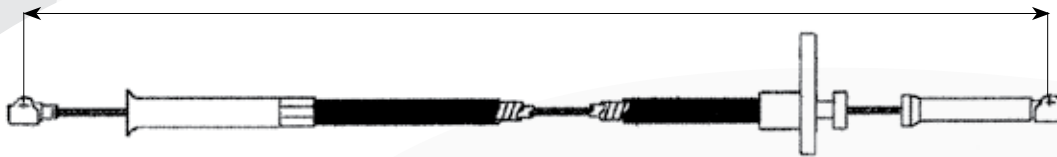

FO-126		69	ACEL. MUSTANG AUTOMATICO	575
--------	--	----	--------------------------	-----

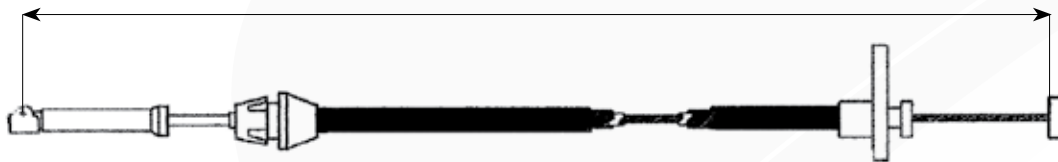

FO-128		92-	ACEL. MICROBUS FORD	1045
FO-137	M4068380-AD	91-	ACEL. FORD CAMIONETA PICK UP AMERICANA (Y6092)	1065
FO-149			CAMION FORD 300 6 CIL	1085

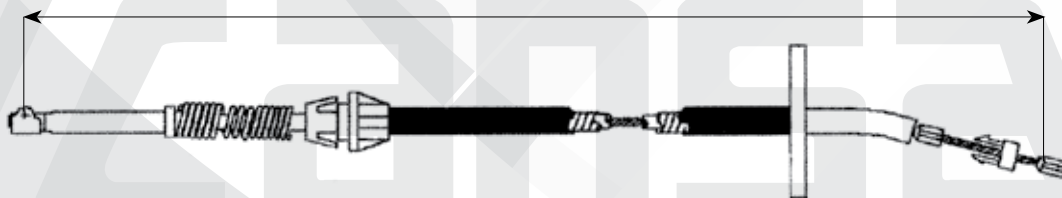

FO-130		93	ACEL. MICROBUS FORD	1025
FO-131		88-89	ACEL. F350 8 CIL.	754
FO-132	E3TZ-9A758B	83-86	ACEL. CAMIONETA PICK UP F100-350 & U150 BRONCO ENG 300 (USA)	790

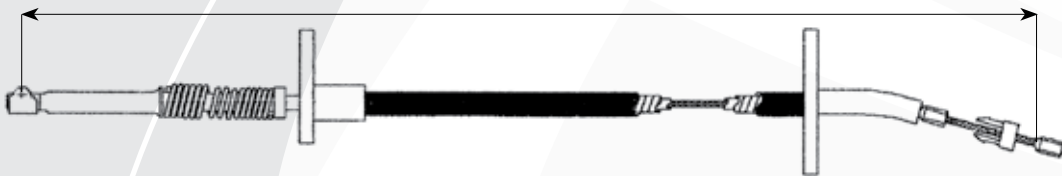

FO-133	96FB9C799JG	1998-	ACEL. FIESTA	1843
--------	-------------	-------	--------------	------



Importante: La información indicada en esta publicación, ha sido obtenida por fuentes confiables y oficiales, consideramos que es correcta, sin embargo no asumimos ninguna responsabilidad por errores, cambios, omisiones o daños que resulten de estos.

NUMERO DE PARTE PART NUMBER	NUMERO DE CLIENTE CUSTOMER NUMBER	AÑO / YEAR	VEHICULO / VEHICLE	LONG. A
FO-134	96BB9C799AD	1999-00	ACEL. CONTOUR	1115



FO-144		96-	ACELERADOR AEROSTAR	540
--------	--	-----	---------------------	-----



FO-145	F1TZ-9A758-AB	98-02	ACELERADOR TRITON F-350 MOTOR 5.4L, 8 CIL.	1319
--------	---------------	-------	--	------

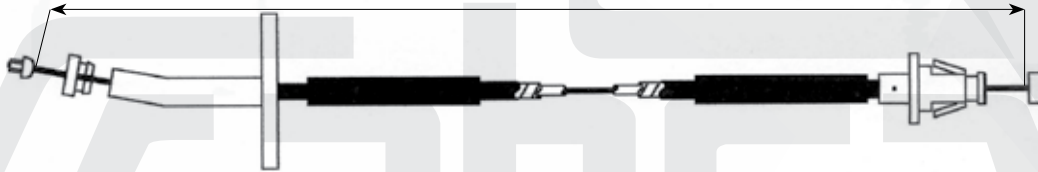

FO-146	XS619C799CA	2003-	ACELERADOR IKON	973
--------	-------------	-------	-----------------	-----



FO-150	XS8Z 9A758 DA	01-04	FORD MONDEO TRANS MANUAL	916
--------	---------------	-------	--------------------------	-----



FO-151	98BB 9C799 CB	01-04	FORD MONDEO TRANS AUTOMATICA	969
--------	---------------	-------	------------------------------	-----

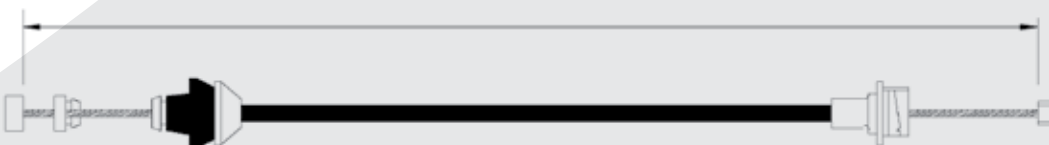

\*Importante: La información indicada en esta publicación, ha sido obtenida por fuentes confiables y oficiales, consideramos que es correcta, sin embargo no asumimos ninguna responsabilidad por errores, cambios, omisiones o daños que resultaran de estos\*.



# Cables de Acelerador / Accelerator Cables



NUMERO DE PARTE PART NUMBER	NUMERO DE CLIENTE CUSTOMER NUMBER	AÑO / YEAR	VEHICULO / VEHICLE	LONG. A
FO-152	XL3Z 9A758 AA XL34-9A758-AH	98-00	FORD LOBO 8 CILINDROS	808



FO-153	1L3Z 9A758 BA 1L34-9A758-BA	98-00	FORD LOBO 6 CILINDROS	1246
--------	--------------------------------	-------	-----------------------	------



FO-154		1986	FORD RANGER V6	700
--------	--	------	----------------	-----

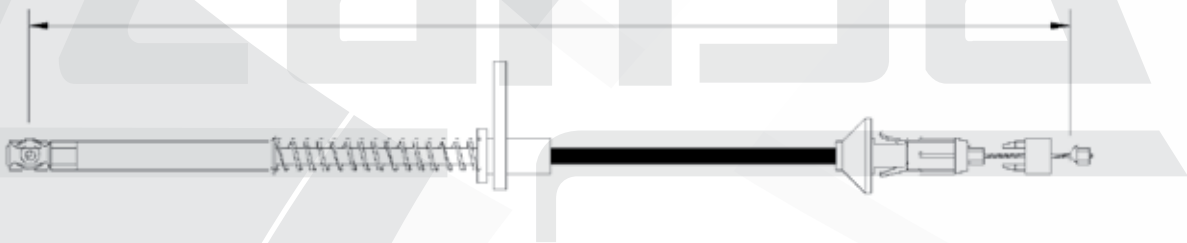

FO-155		78-88	ACELERADOR RANGER USA 4 CIL.	910
--------	--	-------	------------------------------	-----

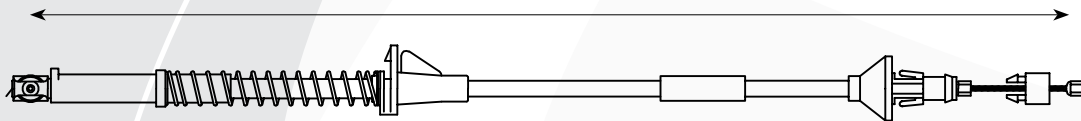

FO-156		86-90	ACELERADOR F-150 XLT VARIANT, BRONCO FUEL INJECTION	1070
FO-160		86-	C. DE ACELERADOR FORD PICK UP F300	575

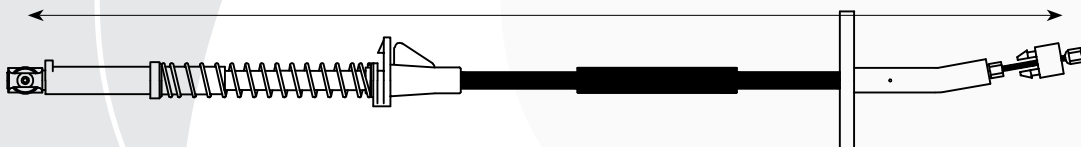

Importante: La información indicada en esta publicación, ha sido obtenida por fuentes confiables y oficiales, consideramos que es correcta, sin embargo no asumimos ninguna responsabilidad por errores, cambios, omisiones o daños que resulten de estos.

Cables de Acelerador // Accelerator Cables

NUMERO DE PARTE PART NUMBER	NUMERO DE CLIENTE CUSTOMER NUMBER	AÑO / YEAR	VEHICULO / VEHICLE	LONG. A
FO-157		84-88	ACELERADOR CORTO RANGER USA 4 CIL.	880

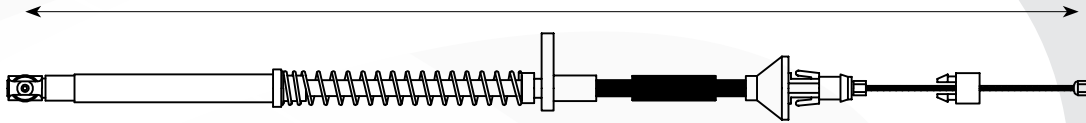

FO-158		-88	ACELERADOR RANGER USA MOTOR 4.0L V6 CIL, FUEL INJECTION	863
FO-159		1990	ACELERADOR AEROSTAR USA, 6 CIL.	1123

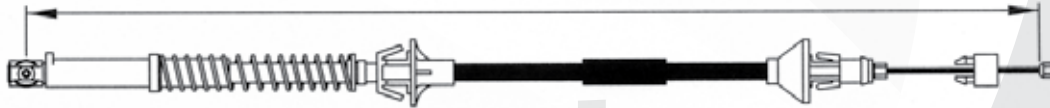

FO-161		1993	C. DE ACELERADOR FORD TOPAZ FUEL INJ.	1300
--------	--	------	---------------------------------------	------

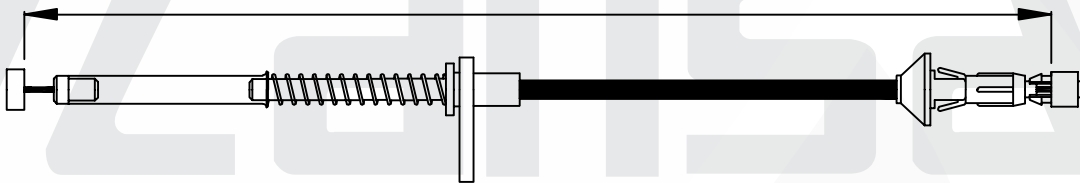

FO-162		88-92	C. DE ACELERADOR PICK UP	575
--------	--	-------	--------------------------	-----

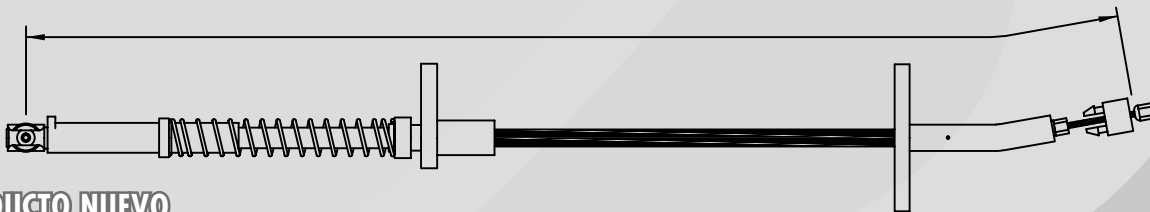

**PRODUCTO NUEVO**

FO-163	M 2N15-9C799-AB	03-	C. DE ACELERADOR ECOSPORT STD	1085
--------	-----------------	-----	-------------------------------	------

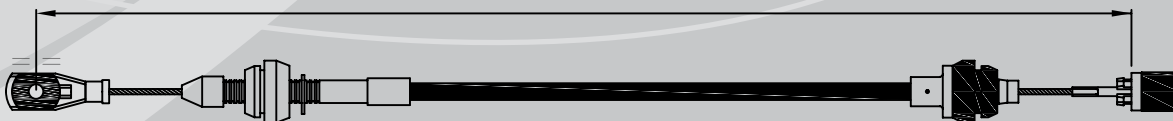

**PRODUCTO NUEVO**

"Importante: La información indicada en esta publicación, ha sido obtenida por fuentes confiables y oficiales, consideramos que es correcta, sin embargo no asumimos ninguna responsabilidad por errores, cambios, omisiones o daños que resultaran de estos".

Cables de Acelerador // Accelerator Cables



# Cables de Acelerador / Accelerator Cables



NUMERO DE PARTE PART NUMBER	NUMERO DE CLIENTE CUSTOMER NUMBER	AÑO / YEAR	VEHICULO / VEHICLE	LONG. A
FO-164	M 7N15-9C799-AC	03-	C. DE ACELERADOR ECOSPORT AUTOMATICO	1240

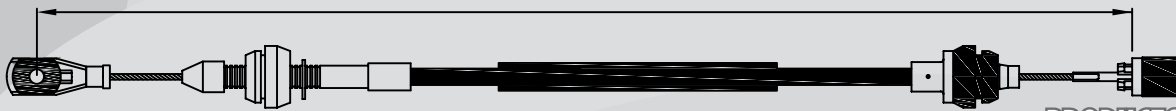

PRODUCTO NUEVO

FO-165	101442-1004 TRA 721 555	93-95	FORD CARGO 1215/1217/1415 - CUMMINS CARGO 1417- 4 /19 ... 10/95 CARGO 1617- 5 /93 ... 10/95	2047
FO-166	96HU AC799 AB 2UH 721 555		FORD CARGO 814/915	1330
FO-167	2SW7215555 TRA 721 555	95-97	FORD CARGO 12630 (8 HC)/ 1622-95 ... CARGO 3520 (8HE) - 95 -97 CARGO 2425 (8HC) - 95 ... CARGO 3530 (8 HC) - 95 - 97	1822



PRODUCTO NUEVO

FO-168		98-02	C. DE ACELERADOR FORD ESCORT ZX2 2.0L	1350
--------	--	-------	---------------------------------------	------



PRODUCTO NUEVO



NUMERO DE PARTE PART NUMBER	NUMERO DE CLIENTE CUSTOMER NUMBER	AÑO / YEAR	VEHICULO / VEHICLE	LONG. A
--------------------------------	--------------------------------------	------------	--------------------	---------

FT-100	7606511		ACEL. UNO/S/CS/FURGONETA 1.5 91/91 x FLORINO 5/1.6	1055
FT-106	7606511/7665	87-	ACEL. UNO TREND 1116cc (BRASIL) UNO CS ; DIONA; FIORINO 1.3 AUT. TRANS.	1055

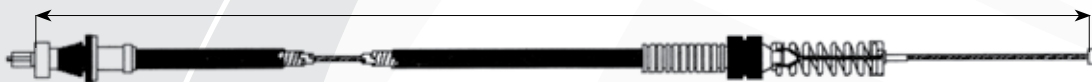

FT-101	4359989		ACEL. 127 1050 cc 147/SPAZZIO/OGGI (BRASIL)	667
FT-105	5963186	86-91	ACEL. UNO S/CS/SX/FURGONETA/MILLE 1.0/1.3/1.5 PREMIO 1.3 ATE	773
FT-108	4473012/4378	79-	ACEL. 131 DS (BOSCH) TRANS. AUTOMATIC	437

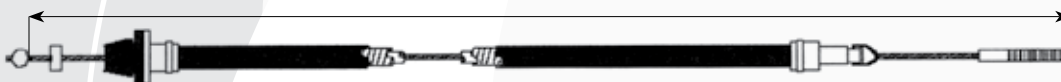

FT-102	7320131		ACEL. PREMIO 51.5 MILLE 91 ED/UNO S/CS/ FURGONETA/ELBA/WEEK END/FIORINO 1.5	1086
FT-104	7521026	93	ACEL. UNO S/CS; PREMIO S/SL; ELBA WEEK END ED	1047



Importante: La información indicada en esta publicación, ha sido obtenida por fuentes confiables y oficiales, consideramos que es correcta, sin embargo no asumimos ninguna responsabilidad por errores, cambios, omisiones o daños que resulten de estos.

NUMERO DE PARTE PART NUMBER	NUMERO DE CLIENTE CUSTOMER NUMBER	AÑO / YEAR	VEHICULO / VEHICLE	LONG. A
FT-103	7667718	-91	ACEL. UNO 1.6R/CSL; PREMIO/ELBA 1.6 ED; FIORINO 1.6	1230



FT-107	4413988	78-	ACEL. RITMO TRANS. AUTOMATICA	807
--------	---------	-----	-------------------------------	-----

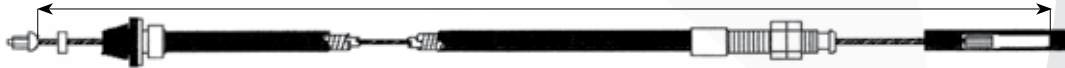

FT-109	5963186	88-	ACEL. UNO CS-1300cc (BRASIL); FIORINO 1.1	778
--------	---------	-----	---	-----



NUMERO DE PARTE PART NUMBER	NUMERO DE CLIENTE CUSTOMER NUMBER	AÑO / YEAR	VEHICULO / VEHICLE	LONG. A
--------------------------------	--------------------------------------	------------	--------------------	---------

GM-100	336975	71-73	ACEL. IMPALA 6 CIL.	590
--------	--------	-------	---------------------	-----



GM-101	3949068	68-69	ACEL. CHEVROLET 6 Y 8 CIL	570
GM-102	3972679	70-72	ACEL. CHEVELLE 6 Y 8 CIL.	550

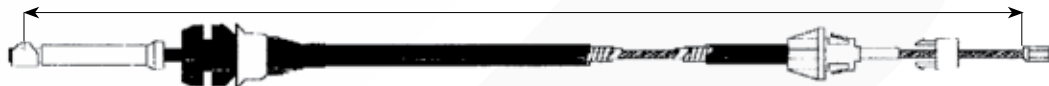

GM-103	1248077	73-74	ACEL. CHEVELLE 8 CIL.	510
GM-107	1248083	75-78	ACEL. CAMION C10/30 MAQ.292	500
GM-108	1248073	77-79	ACEL. CAMION C10/30 MAQ. 350	495
GM-110	1258156	79-81	ACEL. MALIBU 6 CIL.	530
GM-111	1254180	79-81	ACEL. MALIBU 8 CIL.	590
GM-115		80-90	ACEL. CAMION C/10 C/30 MAQ. 350	625
GM-123	1248092	92-	ACEL. CAMION C60 P300 6 CIL.	1741
GM-179		1988	ACEL. S-10 AMERICANO MOTOR V6	870
GM-190	15590109	85-86,96	ACEL. ASTRO, S10 BLAZER, PICK UP, S15, JIMMY, SAFARI	1008

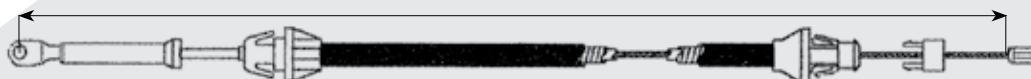

\*Importante: La información indicada en esta publicación, ha sido obtenida por fuentes confiables y oficiales, consideramos que es correcta, sin embargo no asumimos ninguna responsabilidad por errores, cambios, omisiones o daños que resultaran de estos.\*

Cables de Acelerador // Accelerator Cables



# Cables de Acelerador / Accelerator Cables



Cables de Acelerador / Accelerator Cables

NUMERO DE PARTE PART NUMBER	NUMERO DE CLIENTE CUSTOMER NUMBER	AÑO / YEAR	VEHICULO / VEHICLE	LONG. A
--------------------------------	--------------------------------------	------------	--------------------	---------

GM-104	336923	73-74	ACEL. CHEVY NOVA 6 CIL.	480
--------	--------	-------	-------------------------	-----



GM-105	1246650	75-76	ACELERADOR CHEVY NOVA 6 CIL.	505
--------	---------	-------	------------------------------	-----

GM-106	1254175	76-78	ACELERADOR CHEVY NOVA 6 Y 8 CIL.	525
--------	---------	-------	----------------------------------	-----

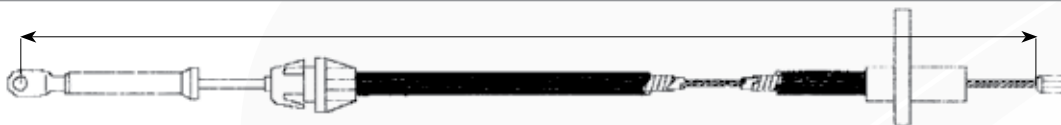

GM-109	1258506	78-83	ACEL. CAPRICE	530
--------	---------	-------	---------------	-----

GM-113	4767961	82-85	ACEL. CITATION CELEBRITY V6	770
--------	---------	-------	-----------------------------	-----



GM-112	3998768	82-94	ACEL. VANETTE Y MICROBUS	1730
--------	---------	-------	--------------------------	------



GM-114			ACEL. CAMION C/10 C/30	490
--------	--	--	------------------------	-----

GM-117	1248092	75-80	ACEL. CAMION C/60 P/300 6 CIL.	1725
--------	---------	-------	--------------------------------	------

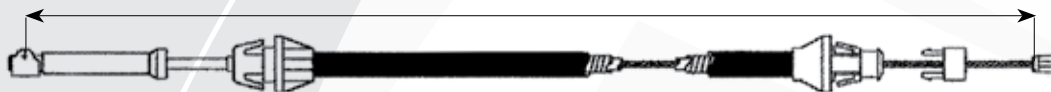

GM-116		71-75	ACEL. VANETTE PS-300 8 CIL.	1280
--------	--	-------	-----------------------------	------

GM-118	3978768	72-73	ACEL. VANETTE PS-300 6/8 CIL.	790
--------	---------	-------	-------------------------------	-----

GM-119	6264929	91-95	ACEL. CAMIONETA C-10/C-30	505
--------	---------	-------	---------------------------	-----

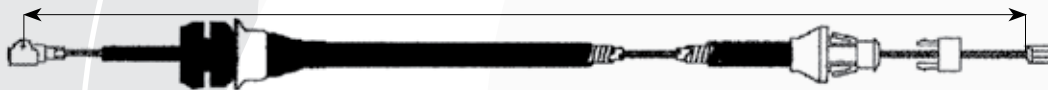

GM-120	15990937	91-95	ACEL. MICROBUS	1705
--------	----------	-------	----------------	------

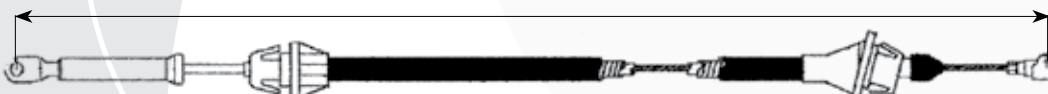

Importante: La información indicada en esta publicación, ha sido obtenida por fuentes confiables y oficiales, consideramos que es correcta, sin embargo no asumimos ninguna responsabilidad por errores, cambios, omisiones o daños que resulten de estos.

NUMERO DE PARTE PART NUMBER	NUMERO DE CLIENTE CUSTOMER NUMBER	AÑO / YEAR	VEHICULO / VEHICLE	LONG. A
GM-121	10079816	90-94	ACEL. CAVALIER STD.	820
GM-191		1996	ACEL. CUTLASS AMERICANO	525



GM-122	90411035	94-96	ACEL. CHEVY CORSA	770
GM-147	90411031	96-	ACEL. CHEVY, CHEVY POP, MONZA, CHEVY JOY	837

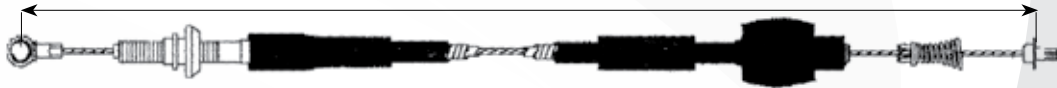

GM-146	94626706	1987	ACEL. CHEVROLET CHEVETTE 1400 (EXPORTACIÓN)	774
--------	----------	------	---	-----



GM-152	15959410	1997-	ACEL. BLAZER S500	887
GM-180		1996	ACEL. BLAZER V6 USA	1050

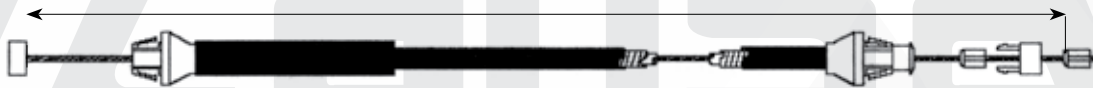

GM-153	3539924	88	ACEL. CENTURY	986
--------	---------	----	---------------	-----

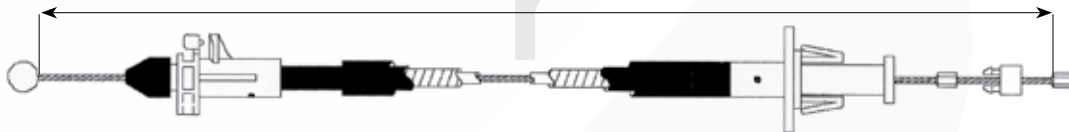

GM-157	1258156	74-84	ACEL. MALIBU, EL CAMINO, MONTE CARLO V6 200,229	514
		78-87	CABALLERO, BONNEVILLE V6 200, 229, 262	
		86-87	GRAND PRIX V6 262, 4.3LT	
		80-81	Z, LEMANS Y GRAND AM, V6 229 3.8 LT	
GM-162	1258156	78-84	ACEL. MALIBU, EL CAMINO, MONTE CARLO, V6 200, 229, 262	514



GM-163		1996-2000	ACEL. SUBURBAN AUT.	635
--------	--	-----------	---------------------	-----

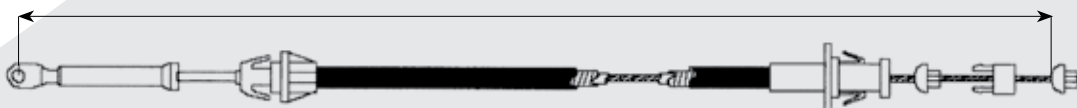

"Importante: La información indicada en esta publicación, ha sido obtenida por fuentes confiables y oficiales, consideramos que es correcta, sin embargo no asumimos ninguna responsabilidad por errores, cambios, omisiones o daños que resultaran de estos".



# Cables de Acelerador / Accelerator Cables



NUMERO DE PARTE PART NUMBER	NUMERO DE CLIENTE CUSTOMER NUMBER	AÑO / YEAR	VEHICULO / VEHICLE	LONG. A
--------------------------------	--------------------------------------	------------	--------------------	---------

GM-164	15551476	1987-91	ACEL. C, K, & R, V SERIES (PICK UP, BLAZER, JIMMY & SUBURBAN) 10/30 4.3-Z, 5.0-H, 350-K, 7.4-M-N	729
GM-165	15622442	1988-91	ACEL. S,T SERIES (COMPACT BLAZER, BRAVADA, JIMMY & PICK UP, EXCEPT 1991 INTERMEDIATE DESIGN CHANGE CTF 4.3-Z	789
GM-168		1986	ACEL. CAMIONETA USA MOTOR V6, V8	1490

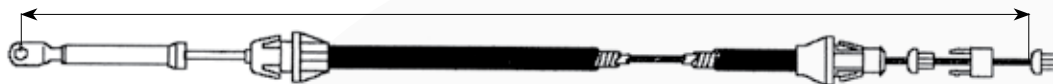

GM-166	22615815	2000-03	ACEL. CAVALIER 2.2 L, 2.4L	1596
--------	----------	---------	----------------------------	------

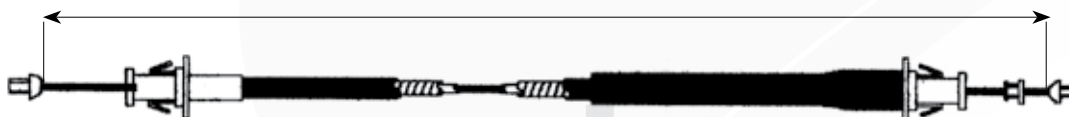

GM-167			ACEL. MICROBUS	1680
--------	--	--	----------------	------

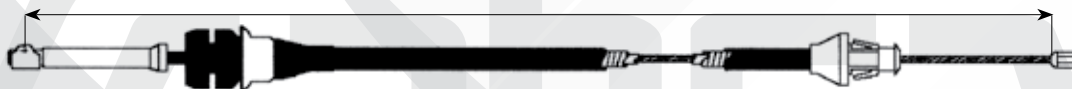

GM-177	15994697	1994	ACEL. LL V (POSTAL VEHICLE) L4 2.2L 134 cid GAS F. INJ ENGINE VIN=4 (EXPORTACIÓN)	1695
--------	----------	------	---	------



GM-178	15622445	87-93	ACEL. LL V (POSTAL VEHICLE) L4 2.5L 2474cc 151 cid F. INJ ENGINE VIN=A (EXPORTACIÓN)	1260
--------	----------	-------	--	------



GM-182	93428148	92-00	ACELERADOR CHEVROLET K1500, K2500, SUBURBAN V8 5.7L 350 cid GAS FI N ENGINE VIN: R,K	773
--------	----------	-------	--	-----

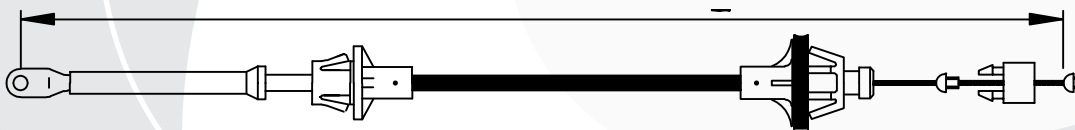

Importante: La información indicada en esta publicación, ha sido obtenida por fuentes confiables y oficiales, consideramos que es correcta, sin embargo no asumimos ninguna responsabilidad por errores, cambios, omisiones o daños que resulten de estos.

NUMERO DE PARTE PART NUMBER	NUMERO DE CLIENTE CUSTOMER NUMBER	AÑO / YEAR	VEHICULO / VEHICLE	LONG. A
GM-185	22618841	97-00	ACELERADOR PONTIAC SUNFIRE	1295
GM-189		1997	ACEL CHEVROLET MALIBU 1997 AUT, 2.4 L (AMERICANO)	1430

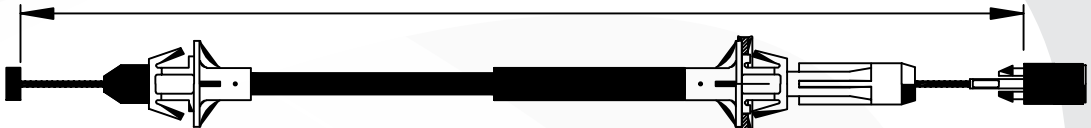

GM-186	22619740	99-03	ACELERADOR CHEVROLET MALIBU V6	1035
--------	----------	-------	--------------------------------	------

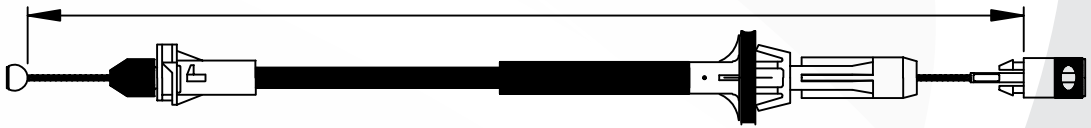

GM-187	12563915	97-05	ACELERADOR CHEVROLET VENTURE V6	965
--------	----------	-------	---------------------------------	-----



GM-188	10111605	91-96	DOBLE ACEL-SOBREMARCHA CUTLASS	INF1275, SUP1223
--------	----------	-------	--------------------------------	------------------

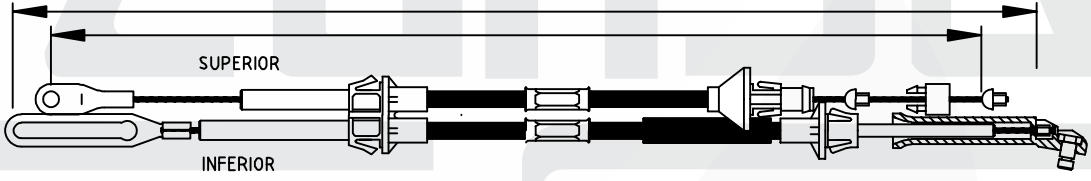

GM-192		1996	C. ACCELERADOR BLAZER	1095
--------	--	------	-----------------------	------

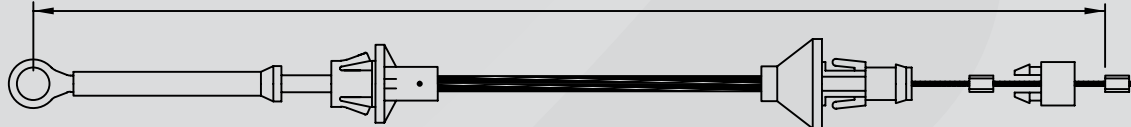

**PRODUCTO NUEVO**

GM-193	3017100414	2011-	C. ACCELERADOR SPARK 1.2 L	1448
--------	------------	-------	----------------------------	------

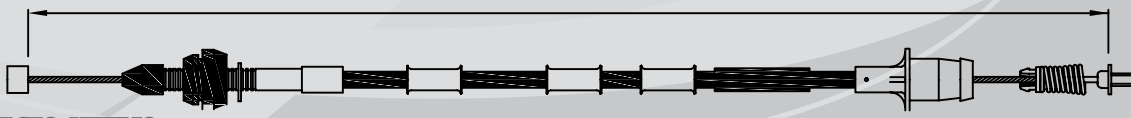

**PRODUCTO NUEVO**

DW-102	96490240	2006	C. ACCELERADOR PONTIAC MATIZ	1510
--------	----------	------	------------------------------	------

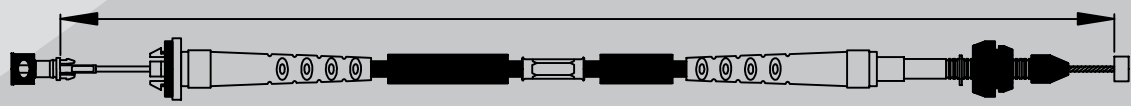

**PRODUCTO NUEVO**

"Importante: La información indicada en esta publicación, ha sido obtenida por fuentes confiables y oficiales, consideramos que es correcta, sin embargo no asumimos ninguna responsabilidad por errores, cambios, omisiones o daños que resultaran de estos".

NUMERO DE PARTE PART NUMBER	NUMERO DE CLIENTE CUSTOMER NUMBER	AÑO / YEAR	VEHICULO / VEHICLE	LONG. A
HY-100	32790 2400	94-	ACEL. HYUNDAI ACCENT	1572



HY-101	327 9024000	93-	ACEL. HYUNDAI EXCEL	970
HY-106	3279021001	86-89	ACEL. HYUNDAI EXCEL	1100



HY-102	327 4043240		ACEL. HYUNDAI FURGON H-100	2285
--------	-------------	--	----------------------------	------



HY-103			ACEL. HYUNDAI EXCEL INYECTADO	1445
HY-105	327902402	90-99	ACEL. HYUNDAI EXCEL INYECTADO	1460



HY-104	3279002010	2000-	ACEL. HYUNDAI ATOS MOTOR 1.1 (5071175AA)	720
--------	------------	-------	--	-----

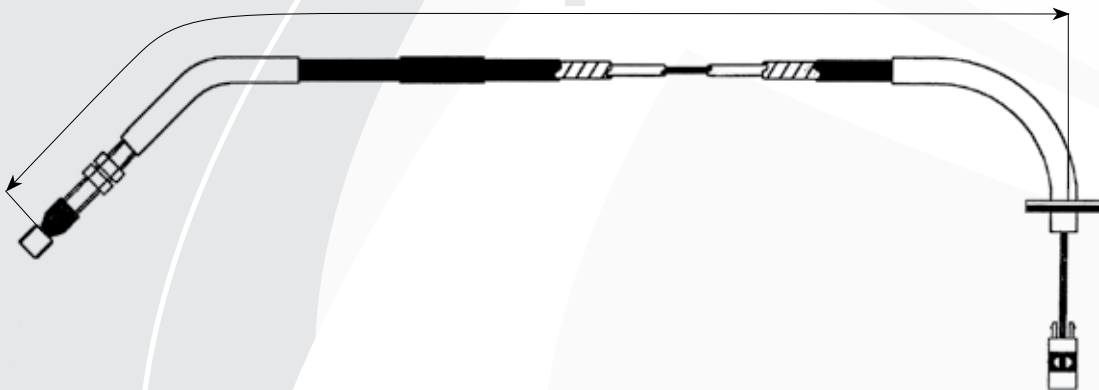

HY-107	32740-4B000	1997	C. DE ACCELERADOR H100 PORTER	2855
--------	-------------	------	-------------------------------	------

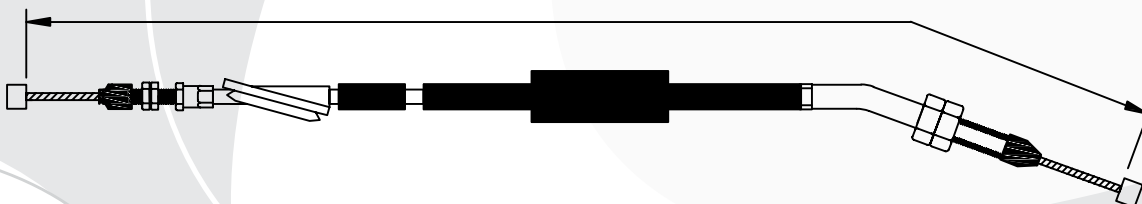

Importante: La información indicada en esta publicación, ha sido obtenida por fuentes confiables y oficiales, consideramos que es correcta, sin embargo no asumimos ninguna responsabilidad por errores, cambios, omisiones o daños que resulten de estos.

NUMERO DE PARTE PART NUMBER	NUMERO DE CLIENTE CUSTOMER NUMBER	AÑO / YEAR	VEHICULO / VEHICLE	LONG. A
IS-100	894495-0150	88-	ACEL. ISUZU TROOPER	708

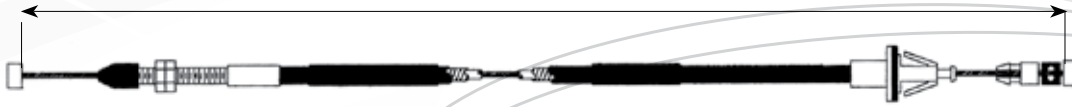

## KODIAK

NUMERO DE PARTE PART NUMBER	NUMERO DE CLIENTE CUSTOMER NUMBER	AÑO / YEAR	VEHICULO / VEHICLE	LONG. A
KD-100	15998935 490227020	94-	ACEL. KODIAK CHEVROLET 6 CIL DIESEL V8 GASOLINA 6L, DIESEL CATERPILLAR 3116K GAS 7L 6CIL EN LINEA	2210

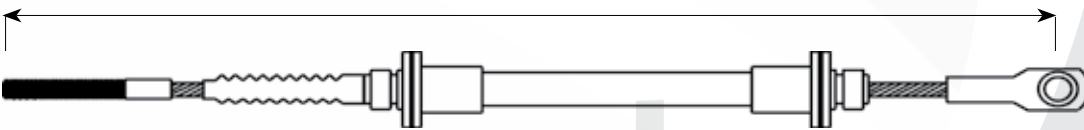

KD-101	156996199		ACELERADOR CAMION KODIAK Y TOP KNICK	590
--------	-----------	--	--------------------------------------	-----



NUMERO DE PARTE PART NUMBER	NUMERO DE CLIENTE CUSTOMER NUMBER	AÑO / YEAR	VEHICULO / VEHICLE	LONG. A
KI-100	OK756 41660F		CABLE DE ACELERADOR KIA	1434



**PRODUCTO NUEVO**

KI-101			CABLE DE ACELERADOR KIA	2032
--------	--	--	-------------------------	------

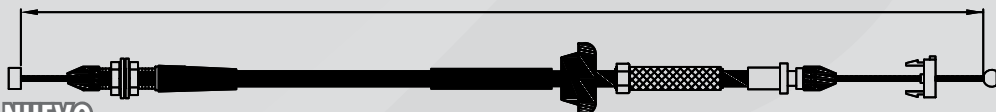

**PRODUCTO NUEVO**

KI-102	SA56-41-660A		C. DE ACEL. KIA BESTA 2,2/97 1,90 Mt MOBIS	2035
--------	--------------	--	--	------

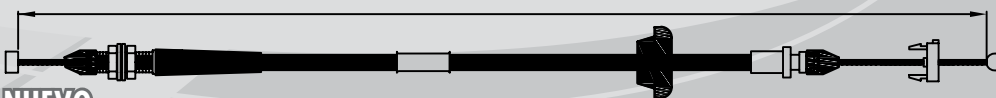

**PRODUCTO NUEVO**

KI-103	K60A-41-660C	98-04	C. DE ACELERADOR KIA FRONTIER MOBIS	2047
--------	--------------	-------	-------------------------------------	------



**PRODUCTO NUEVO**

"Importante: La información indicada en esta publicación, ha sido obtenida por fuentes confiables y oficiales, consideramos que es correcta, sin embargo no asumimos ninguna responsabilidad por errores, cambios, omisiones o daños que resultaran de estos".

Cables de Acelerador / Accelerator Cables

NUMERO DE PARTE PART NUMBER	NUMERO DE CLIENTE CUSTOMER NUMBER	AÑO / YEAR	VEHICULO / VEHICLE	LONG. A
MZ-100	8COB430114A	1988-	ACEL. MAZDA 323 NX/NS	1077

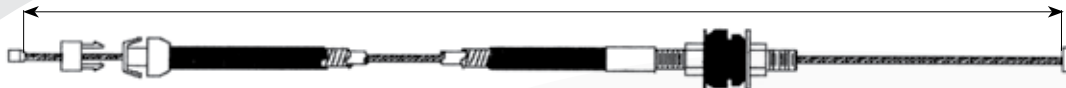

MZ-101		87-	ACEL. MAZDA B2000	683
--------	--	-----	-------------------	-----

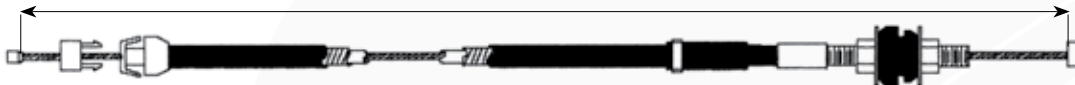

MZ-102	UB39-41-660		ACEL. MAZDA B2000-B2200	680
--------	-------------	--	-------------------------	-----



## NAVISTAR®

NUMERO DE PARTE PART NUMBER	NUMERO DE CLIENTE CUSTOMER NUMBER	AÑO / YEAR	VEHICULO / VEHICLE	LONG. A
NV-100	453694C3	95-00	ACEL. MICROBUS NAVISTAR	730

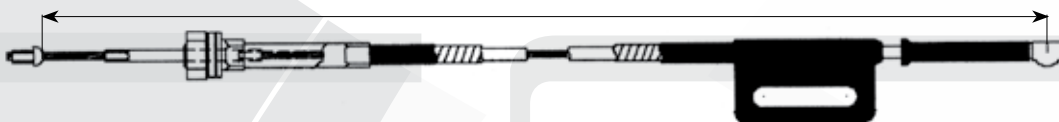

NV-101		TODOS	NAVISTAR MOTOR NGD	1010
--------	--	-------	--------------------	------

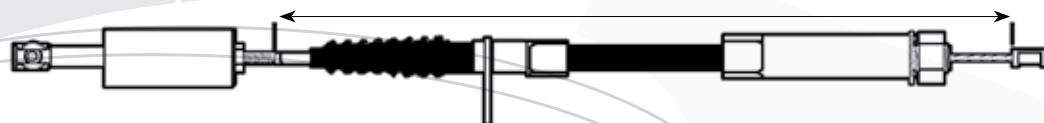

NUMERO DE PARTE PART NUMBER	NUMERO DE CLIENTE CUSTOMER NUMBER	AÑO / YEAR	VEHICULO / VEHICLE	LONG. A
NI-100	18200-B-5500	68-74	ACEL. DATSUN PICK UP	450
NI-101	18200-B-5200	68-74	ACEL. DATSUN SEDAN	475

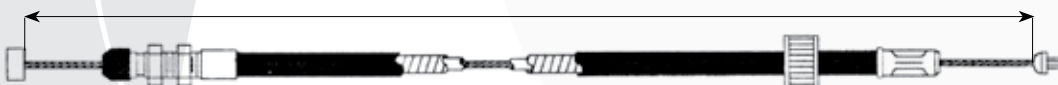

Importante: La información indicada en esta publicación, ha sido obtenida por fuentes confiables y oficiales, consideramos que es correcta, sin embargo no asumimos ninguna responsabilidad por errores, cambios, omisiones o daños que resulten de estos.

Cables de Acelerador // Accelerator Cables

NUMERO DE PARTE PART NUMBER	NUMERO DE CLIENTE CUSTOMER NUMBER	AÑO / YEAR	VEHICULO / VEHICLE	LONG. A
NI-102	18200-B-5502	75-78	ACEL. PICK UP	690

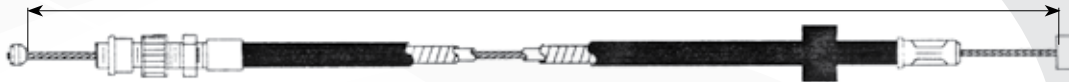

NI-103	18201-W-5602	79-84	ACEL. DATSUN SEDAN	445
--------	--------------	-------	--------------------	-----



NI-104	18200-B-5201	82-86	ACEL. PICK UP	515
--------	--------------	-------	---------------	-----

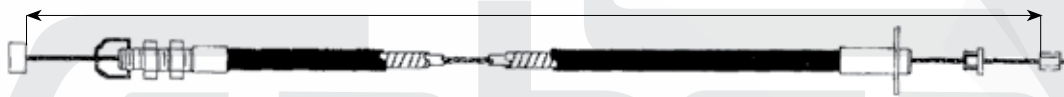

NI-105	18200-232J00	79-81	ACEL. PICK UP	645
--------	--------------	-------	---------------	-----



NI-106	18201-N-7900	82-86	ACEL. SAKURA DATSUN HARD TOP 1800	585
--------	--------------	-------	-----------------------------------	-----



NI-107	18201-A-0360	84-87	ACEL. TSURU I ESTANDARD	650
NI-108	18201-64-A-20	88-92	ACEL. TSURU II AUTOMATICO	775
NI-109		86-88	ACEL. TSURU I AUTOMATICO	660
NI-132	18201-A-03R0	88-	ACEL. SENTRA (82), SUNNY	645

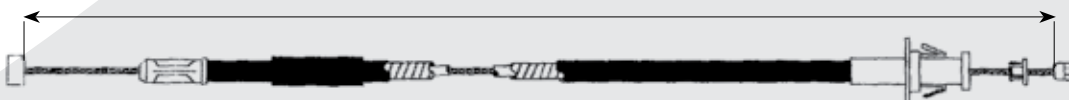

\*Importante: La información indicada en esta publicación, ha sido obtenida por fuentes confiables y oficiales, consideramos que es correcta, sin embargo no asumimos ninguna responsabilidad por errores, cambios, omisiones o daños que resultaran de estos.\*



# Cables de Acelerador / Accelerator Cables



NUMERO DE PARTE PART NUMBER	NUMERO DE CLIENTE CUSTOMER NUMBER	AÑO / YEAR	VEHICULO / VEHICLE	LONG. A
NI-110	18200-B-80R1	80-85	ACEL. PICK UP SOPORTE IZQ.	490
NI-111	18200-33-WR0	80-86	ACEL. PICK UP SOPORTE DERECHO	500
NI-139		86-91	ACEL. PICK UP Z22, Z24 SOPORTE IZQUIERDO	915
NI-140		88-91	ACEL. PICK UP 2.4L AMERICANO	707

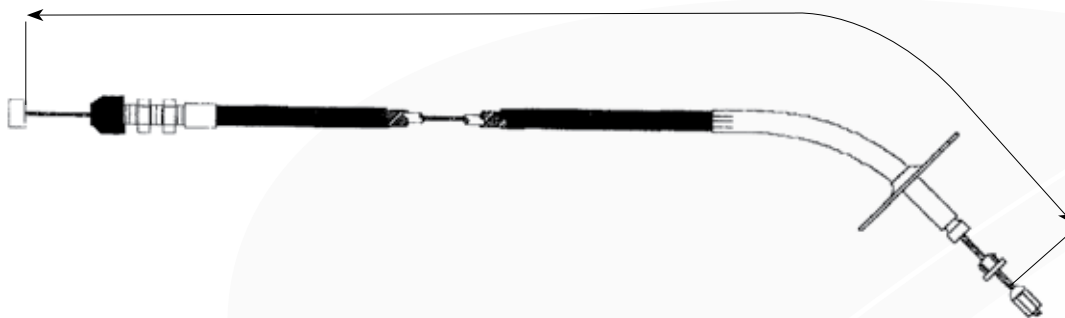

NI-112	18200-B-9701	79-85	ACEL. PICK UP SOPORTE DERECHO	690
NI-116	1820192W05	91-	ACEL. CAMIONETA PICK UP 2.4	1165
NI-117	18200P05R1	83-92	ACEL. PICK UP	620
	18200P05G0			
NI-122		88-90	ACEL. PICK UP	630
NI-147	18200-03W00	79-85	ACELERADOR DATUSN 720-G720, SOPORTE DERECHO	715



NI-113	18201-C07R0	87-91	ACEL. ICHIVAN CARBURADOR HITACHI	1700
--------	-------------	-------	----------------------------------	------



NI-114	18201-C07R0	87-88	ACEL. ICHIVAN CARBURADOR BOCAR	1825
--------	-------------	-------	--------------------------------	------

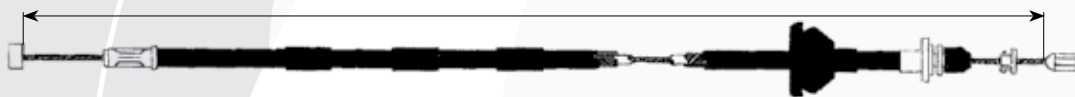

NI-115		88-91	ACEL. TSURU II ESTANDARD	810
--------	--	-------	--------------------------	-----



Importante: La información indicada en esta publicación, ha sido obtenida por fuentes confiables y oficiales, consideramos que es correcta, sin embargo no asumimos ninguna responsabilidad por errores, cambios, omisiones o daños que resulten de estos.

NUMERO DE PARTE PART NUMBER	NUMERO DE CLIENTE CUSTOMER NUMBER	AÑO / YEAR	VEHICULO / VEHICLE	LONG. A
NI-118	1820175Y00	92-00	ACEL. TSURU III, GST, GS	1154
NI-120	1820162Y02	93	ACEL. TSUBAME TSURU & SENTRA MOTOR GA16 DNE VRG 81	1883
NI-128	18201-60A00	87-90	ACEL. TSURU & SENTRA MOTOR B12	1010
NI135		94-96	ACEL. TSURU III (TAPA ROJA)	1725
NI148	18201-F4204	-2005	ACELERADOR TSURU III	1342

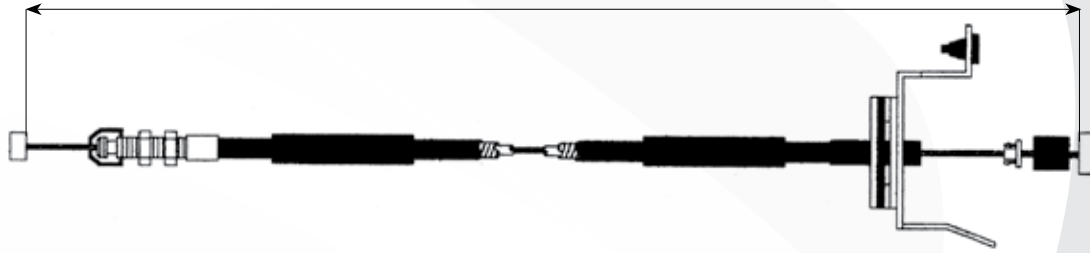

NI-119	18200B03R1	86-88	ACEL. PICK UP	470
NI-121			ACEL. CAMIONETA PICKUP	495



NI-123		1990-	ACEL. PICK UP CARBURADOR SOLEX	615
--------	--	-------	--------------------------------	-----



NI-124	18200 B9801		ACEL. NISSAN 620	495
--------	-------------	--	------------------	-----

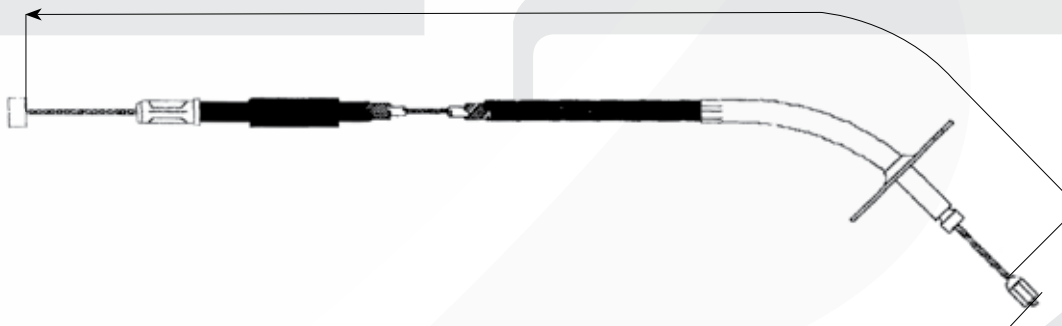

NI-125	18200 H8802		ACEL. NISSAN B310	525
--------	-------------	--	-------------------	-----

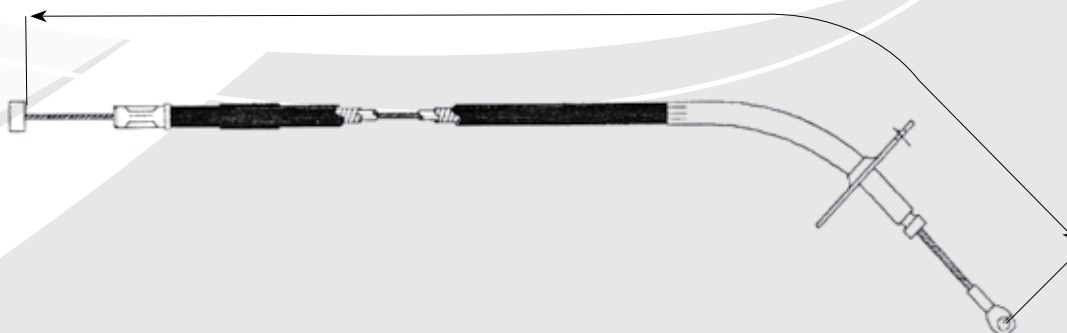

"Importante: La información indicada en esta publicación, ha sido obtenida por fuentes confiables y oficiales, consideramos que es correcta, sin embargo no asumimos ninguna responsabilidad por errores, cambios, omisiones o daños que resultaran de estos".



# Cables de Acelerador / Accelerator Cables



NUMERO DE PARTE PART NUMBER	NUMERO DE CLIENTE CUSTOMER NUMBER	AÑO / YEAR	VEHICULO / VEHICLE	LONG. A
NI-126	18201 04A10	97-98	ACEL. NISSAN SENTRA B11,B14, 16V	1998

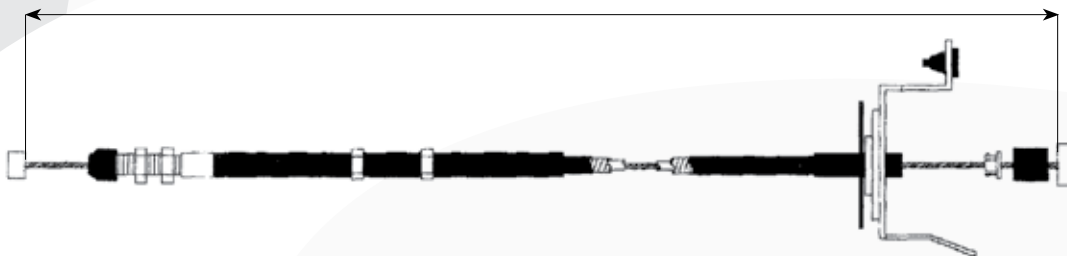

NI-127			ACEL. DATSUN PICK UP AMERICANA	1050
--------	--	--	--------------------------------	------

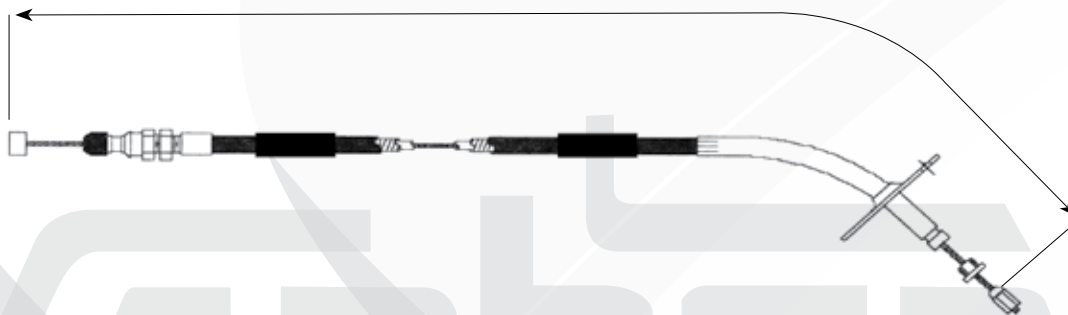

NI-129		2000-	ACELERADOR CAMIONETA URVAN STD 2.4 TWIN CAM	1930
NI-149		2007-	ACELERADOR CAMIONETA URVAN STD 2.4 TWIN CAM	2350



NI-130	18200-23W00	2002-	ACELERADOR PLATINA ESTANDAR 1.6L	1330
--------	-------------	-------	----------------------------------	------

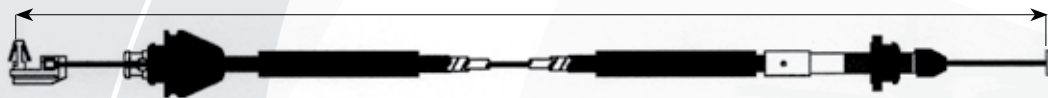

NI-131	18200-23W00		ACEL. NISSAN MOTOR T-20J18	520
NI-142	18200-44W00	86-91	ACEL PICK UP Z24 720 AMERICANA, SOP DER	915



Importante: La información indicada en esta publicación, ha sido obtenida por fuentes confiables y oficiales, consideramos que es correcta, sin embargo no asumimos ninguna responsabilidad por errores, cambios, omisiones o daños que resulten de estos.

NUMERO DE PARTE PART NUMBER	NUMERO DE CLIENTE CUSTOMER NUMBER	AÑO / YEAR	VEHICULO / VEHICLE	LONG. A
NI-133	18201-62J02	90-94	ACELERADOR NISSAN SENTRA V16 E16E, SR20DE MOTOR B13	2040



NI-134	K30511820 186500	1992	ACELERADOR NISSAN PICK UP LARGO LUJO T/A AMERICANA	875
NI-136		90-96	ACEL. PICK UP 2.4L 4 BUJIAS AMERICANA	810
NI-137		80-89	ACEL. PICK UP Z24 8 BUJIAS (CARBURADO) AMERICANO	1230
NI-138		80-89	ACEL. PICK UP Z24 8 BUJIAS (FUEL INJ AMERICANO)	1350



NI-141	18201-0W000	1996	ACEL. PATHFINDER V6 VG33E 3.3L 3275 cc GAS F.I. (A)	1175
--------	-------------	------	---	------



NUMERO DE PARTE PART NUMBER	NUMERO DE CLIENTE CUSTOMER NUMBER	AÑO / YEAR	VEHICULO / VEHICLE	LONG. A
PG-100	162960	TODOS	ACEL. PEUGEOT 206 & 307	2690

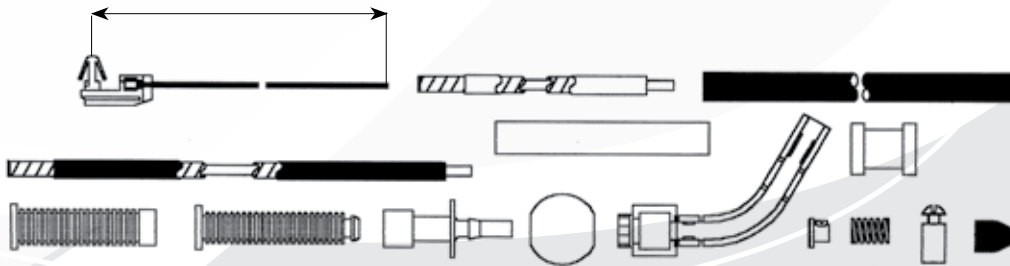

PG-101	1630247X1		ACEL. PEUGEOT 405	602
--------	-----------	--	-------------------	-----

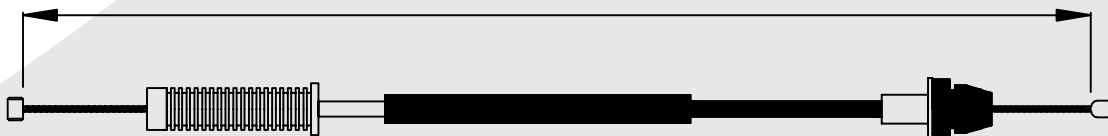

"Importante: La información indicada en esta publicación, ha sido obtenida por fuentes confiables y oficiales, consideramos que es correcta, sin embargo no asumimos ninguna responsabilidad por errores, cambios, omisiones o daños que resultaran de estos".

NUMERO DE PARTE PART NUMBER	NUMERO DE CLIENTE CUSTOMER NUMBER	AÑO / YEAR	VEHICULO / VEHICLE	LONG. A
PK-100	3733946		ACEL. CAMION PERKINS PD 600	860



PK-101	4225700	80-85	ACEL. CAMION PERKINS	845
--------	---------	-------	----------------------	-----

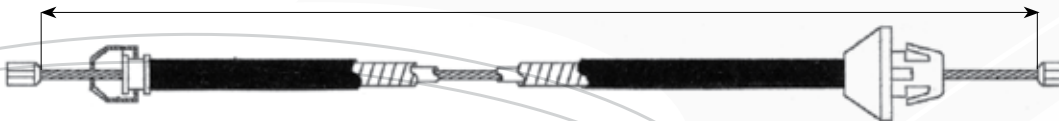

**RENAULT**

NUMERO DE PARTE PART NUMBER	NUMERO DE CLIENTE CUSTOMER NUMBER	AÑO / YEAR	VEHICULO / VEHICLE	LONG. A
RE-100	7701348072	72-76	ACEL. R12 TS	735
RE-102	7700501938	71-72	ACEL. R-12 TL	1000



RE-101	7701348890	75-80	ACEL. R-12 TSP	735
RE-103	7702005057	73-83	ACEL. R-12 TLP	1000



RE-104	7700637336	79-84	ACEL. R-12 R	930
RE-111			ACEL. ALLIANCE ENCORE	540



RE-105	7701348894	-80	ACEL. R-18 (LARGO)	1395
RE-106	7700641399	80-85	ACEL. R R-18 (CORTO)	645
RE-107	7701348134	76-83	ACEL. R-5 MIRAGE	1020



Importante: La información indicada en esta publicación, ha sido obtenida por fuentes confiables y oficiales, consideramos que es correcta, sin embargo no asumimos ninguna responsabilidad por errores, cambios, omisiones o daños que resulten de estos.

Cables de Acelerador / Accelerator Cables

NUMERO DE PARTE PART NUMBER	NUMERO DE CLIENTE CUSTOMER NUMBER	AÑO / YEAR	VEHICULO / VEHICLE	LONG. A
RE-108			ACEL. R-4	535

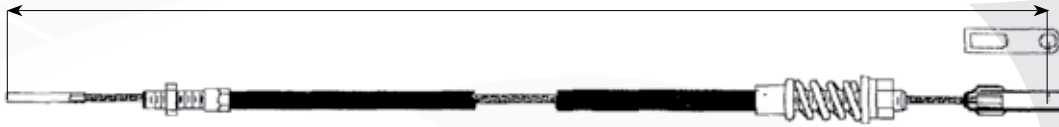

RE-109			ACEL. ESTAFETA	690
--------	--	--	----------------	-----



RE-110	8552463		ACEL. R-8 R-10	2555
--------	---------	--	----------------	------

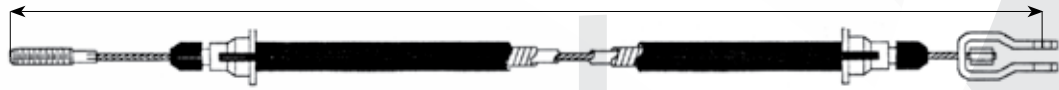

RE-112			ACEL. RENAULT R-18	1395
--------	--	--	--------------------	------

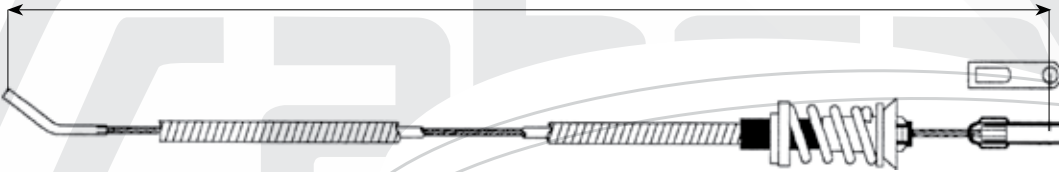

NUMERO DE PARTE PART NUMBER	NUMERO DE CLIENTE CUSTOMER NUMBER	AÑO / YEAR	VEHICULO / VEHICLE	LONG. A
--------------------------------	--------------------------------------	------------	--------------------	---------

SC-100	489168		C. DE ACCELERADOR 124 E OMNIBUS SCANIA	14003
SC-101	489167		C. DE ACCELERADOR 124 E OMNIBUS SCANIA	14005

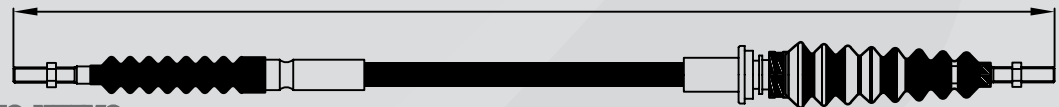

**PRODUCTO NUEVO**

SC-102	416154		C. DE ACCEL. OMNIBUS K112 TRASERO (5.86 Mt)	5863
SC-103	1676130		C. DE ACCEL. OMNIBUS S-4 (3.700 mm) SCANIA	3700
SC-104	1672046		C. DE ACCEL. OMNIBUS K 113 (10.625 mm) SCANIA	10622

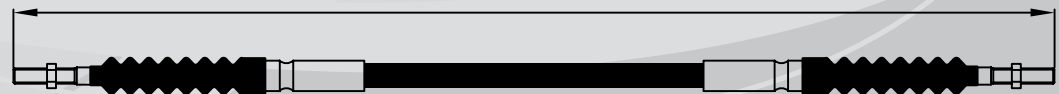

**PRODUCTO NUEVO**

SC-105	1414375	2005	C. DE ACCEL. OMNIBUS T-124 SCANIA	1533
--------	---------	------	-----------------------------------	------

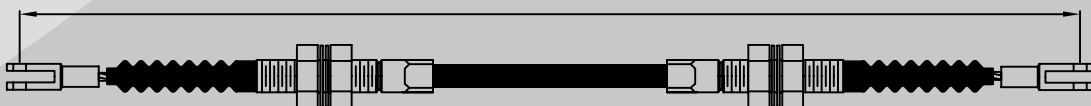

**PRODUCTO NUEVO**

"Importante: La información indicada en esta publicación, ha sido obtenida por fuentes confiables y oficiales, consideramos que es correcta, sin embargo no asumimos ninguna responsabilidad por errores, cambios, omisiones o daños que resultaran de estos".

**SCANIA****Cables de Acelerador / Accelerator Cables**

NUMERO DE PARTE PART NUMBER	NUMERO DE CLIENTE CUSTOMER NUMBER	AÑO / YEAR	VEHICULO / VEHICLE	LONG. A
SC-106	1414377		C. DE ACEL. P94 CAMION 1850 MM SCANIA	1845
SC-107	1414372		C. DE ACEL. P124 CAMION 1700 MM SCANIA	1690
SC-108	1414371		C. DE ACEL. R-124 CAMION 1750 MM SCANIA	1745

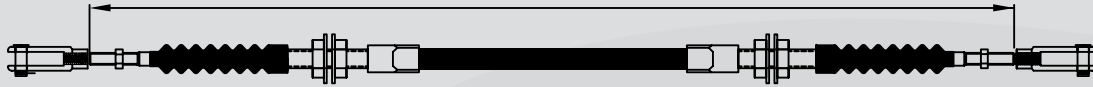
**PRODUCTO NUEVO**

SC-109	302932	-	C. DE ACEL. CAMION T112 0.85 MM SC 302932 SCANIA	764
SC-110	1331139	-	C. DE ACEL. CAMION P93, R143, T113, R113. 93-97 SC	1002
SC-111	309500	-	C. DE ACEL. CAMION R 142 3.63 MM SC 309500 SCANIA	3636

**PRODUCTO NUEVO**

NUMERO DE PARTE PART NUMBER	NUMERO DE CLIENTE CUSTOMER NUMBER	AÑO / YEAR	VEHICULO / VEHICLE	LONG. A
SZ-100	15910 64B02		ACEL. SUZUKI SWIFT 1.0/1.3 GTI	180
SZ-103	15910 63B03	90	ACEL. SUZUKI SWIFT 1.3 CHEVETAXI, SPRINT	190



SZ-101	15910 63B21		ACEL. SUZUKI SWIFT 1.0/1.3 PARTICULAR	1110
--------	-------------	--	---------------------------------------	------



SZ-102	15910 82020A	87-90	ACEL. SUZUKI SPRINT	130
SZ-109	15910M84380	96-98	ACELERADOR MARUTI	160



Importante: La información indicada en esta publicación, ha sido obtenida por fuentes confiables y oficiales, consideramos que es correcta, sin embargo no asumimos ninguna responsabilidad por errores, cambios, omisiones o daños que resulten de estos.

Cables de Acelerador / Accelerator Cables

NUMERO DE PARTE PART NUMBER	NUMERO DE CLIENTE CUSTOMER NUMBER	AÑO / YEAR	VEHICULO / VEHICLE	LONG. A
SZ-104	1591085211		ACEL. SUZUKI 1000	1798
SZ-110	15910-82210/11		ACELERADOR SK 408/410	2118

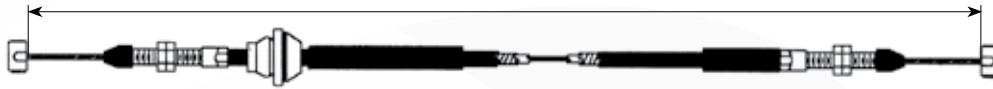

SZ-105	15910 57B11		ACEL. SUZUKI SIDEKICK 16 VALVULAS	880
--------	-------------	--	-----------------------------------	-----



SZ-106	15910 63011		ACEL. SUZUKI SIDEKICK	183
--------	-------------	--	-----------------------	-----



SZ-107	15910 83011		ACEL. SUZUKI SAMURAI	153
--------	-------------	--	----------------------	-----



SZ-108	15910-60G20	96-98	ACELERADOR BALENO	720
--------	-------------	-------	-------------------	-----



\*Importante: La información indicada en esta publicación, ha sido obtenida por fuentes confiables y oficiales, consideramos que es correcta, sin embargo no asumimos ninguna responsabilidad por errores, cambios, omisiones o daños que resultaran de estos.\*

NUMERO DE PARTE PART NUMBER	NUMERO DE CLIENTE CUSTOMER NUMBER	AÑO / YEAR	VEHICULO / VEHICLE	LONG. A
TY-100	7818089125	80-85	ACEL. TOYOTA 4 CIL	695



TY-101	7818089134		ACEL. TOYOTA	1585
--------	------------	--	--------------	------



TY-102	7818089124		ACEL. RN 32, 42	705
--------	------------	--	-----------------	-----



TY-103	7818095115		ACEL.. TOYOTA	663
TY-105	7818095117		ACEL.. TOYOTA	663

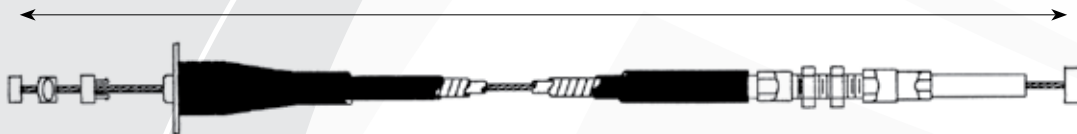

TY-104	7818089126		ACEL. LAND CRUISER RN 40	1467
--------	------------	--	--------------------------	------

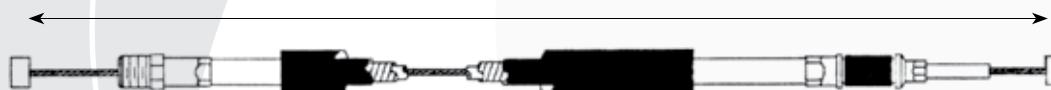

Importante: La información indicada en esta publicación, ha sido obtenida por fuentes confiables y oficiales, consideramos que es correcta, sin embargo no asumimos ninguna responsabilidad por errores, cambios, omisiones o daños que resulten de estos.

NUMERO DE PARTE PART NUMBER	NUMERO DE CLIENTE CUSTOMER NUMBER	AÑO / YEAR	VEHICULO / VEHICLE	LONG. A
TY-106	781801A200		ACEL. TOYOTA EE90 COROLLA	1296



TY-107	7818089157		ACEL. TOYOTA HI-LUX	1610
--------	------------	--	---------------------	------



TY-108	7818089138	85-88	ACEL. TOYOTA HI-LUX	596
--------	------------	-------	---------------------	-----



TY-109	7818089122	73-75	ACEL. TOYOTA LAND CRUISER	1169
--------	------------	-------	---------------------------	------



TY-110		88-	ACELERADOR CAMIONETA PICK UP TOYOTA 4 CIL. MOTOR 22 R. FUEL INJECTION	1025
--------	--	-----	--	------

TY-111		83-86	ACELERADOR TOYOTA CAMIONETA HILUX RN 50-60	947
--------	--	-------	--	-----



NUMERO DE PARTE PART NUMBER	NUMERO DE CLIENTE CUSTOMER NUMBER	AÑO / YEAR	VEHICULO / VEHICLE	LONG. A
VA-100	812014374	67-72	ACEL. AMERICAN JAVELIN CLASSIC	845

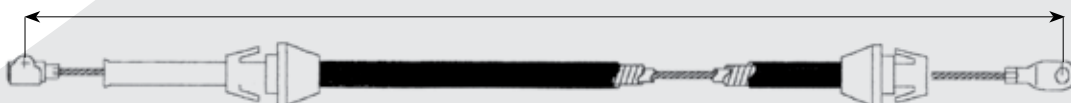

\*Importante: La información indicada en esta publicación, ha sido obtenida por fuentes confiables y oficiales, consideramos que es correcta, sin embargo no asumimos ninguna responsabilidad por errores, cambios, omisiones o daños que resultaran de estos.\*

Cables de Acelerador // Accelerator Cables

NUMERO DE PARTE PART NUMBER	NUMERO DE CLIENTE CUSTOMER NUMBER	AÑO / YEAR	VEHICULO / VEHICLE	LONG. A
VA-101	20090777	72-73	ACEL. CLASSIC JAVELIN	855
VA-102	999923	72-75	ACEL. JEEP DOBLE TRACCION	695
VA-103	3225997	73-77	ACEL. AMERICAN JAVELIN	530
VA-104	3225996	74-76	ACEL. CLASSIC	650
VA-105	3235995	76-78	ACEL. CLASSIC PACER	600
VA-106	3195523	72-76	ACEL. WAGONEER PICK UP	850
VA-107	5356369	77-	ACEL. WAGONEER PICK UP	435
VA-108	5356484	76-79	ACEL. JEEP	780
VA-111	5358677	81-82	ACEL. JEEP RENEGADO 6CIL CJ5/CJ7	540

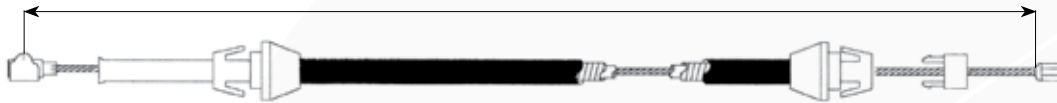

VA-109	323195	78-80	ACEL. AMERICAN GREMLIN	530
--------	--------	-------	------------------------	-----

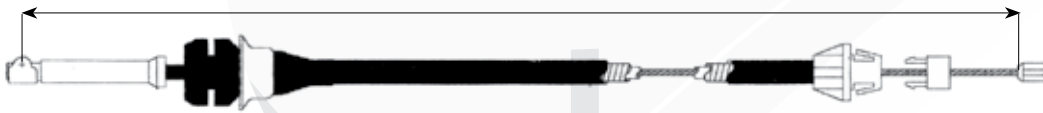

VA-110	T357703	78-80	ACEL. WAGONEER PICK UP	430
--------	---------	-------	------------------------	-----



NUMERO DE PARTE PART NUMBER	NUMERO DE CLIENTE CUSTOMER NUMBER	AÑO / YEAR	VEHICULO / VEHICLE	LONG. A
VW-100	111721555C		ACEL. SEDAN 1200	2626
VW-154	111721555C		ACEL. REFORZADO SEDAN 1200	2626



VW-101	111721555E		ACEL. SEDAN 1500	2625
VW-102	102721555L		ACEL. BRASILIA	2720
VW-102 1	102721555 1		ACEL. BRASILIA DOBLE CARBURACION	2655
VW-102 2	102721555 2		ACEL. BRASILIA CARBURACION SENCILLA	1978
VW-103 A	211721555A	55-64	ACEL. TRANSPORTER 1.2/1.5 L FROM 3/1955 UP TO 8/1964	3612
VW-104	112721555		ACEL. SEDAN 1600 Y SAFARI (111721555D)	2645
VW-105	BAN721555		ACEL. HORMIGA	1232
VW-150	111721555E		ACEL. REFORZADO SEDAN 1500	2627
VW-151	111721555D		ACEL. REFORZADO SEDAN 1600 (112721555)	2645
VW-152	102721555L		ACEL. REFORZADO BRASILIA	2720



Importante: La informacion indicada en esta publicacion, ha sido obtenida por fuentes confiables y oficiales, consideramos que es correcto, sin embargo no asumimos ninguna responsabilidad por errores, cambios, omisiones o daños que resulten de estos.

NUMERO DE PARTE PART NUMBER	NUMERO DE CLIENTE CUSTOMER NUMBER	AÑO / YEAR	VEHICULO / VEHICLE	LONG. A
VW-101J	111721555J	8/71-74	ACEL. BEETLE (SEDAN) & GHIA 8/1971 ONWARDS ALL	2633
VW-118	1B0721555 311721555G	94-2004	ACEL. VW 1600 i ULTIMA GENERACIÓN	2645
VW-155	1B0721555 311721555G	94-2004	ACEL. REFORZADO VW SEDAN 1600 i FI ULTIMA GENERACIÓN	2645



VW-103	211721555P/R/L	-90	ACEL. COMBI PANEL	3670
VW-103 AA	211721555AA	74-79	ACEL. TIPO II (211 721 555S)	3465
VW-103 C	211721555C	64-67	ACEL. TRANSPORTER 1.2/1.5 L	3566
VW-103 G	211721555G	68-71	ACEL. TRANSPORTER 1.6 L	3660
VW-103 T	211721555T	76-	ACEL. TRANSPORTER (211 721 555 M,Q)	3650
VW-116	211721555K		ACEL. COMBI Y PANEL	3655
VW-153	211721555E	-90	ACEL. REFORZADO COMBI PANEL	3665

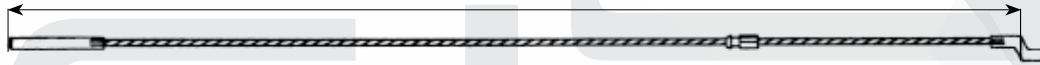

VW-103 J	211721555J	61-72	ACEL. TRANSPORTER 1.6 L	3667
----------	------------	-------	-------------------------	------

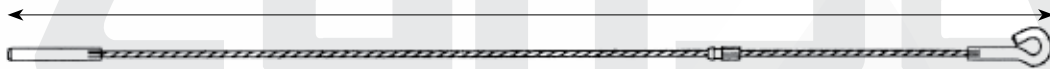

VW-106	531721555F	77-79	ACEL. CARIBE ATLANTIC STD.	1025
--------	------------	-------	----------------------------	------



VW-107	171721555R	80-87	ACEL. CARIBE ATLANTIC STD.	1050
VW-107J/K	171721555J/K	-75	ACEL. SCIROCCO JETTA WITH FUEL INJECTION ENG./GOLF & RABBIT	1142



VW-107 T	171721555T	70-78	ACEL. GOLF S/LS/GLS RABBIT JETTA 70PS-D	1054
VW-110	171721555B/J/H/P	87-92	ACEL. GOLF/JETTA STD.	1050
VW-137	191721 555	85-	ACEL. GOLF TRANSMISION MANUAL	778
VW-141	7DI721555	00-04	ACELERADOR EUROVAN 1.8L	1160



\*Importante: La información indicada en esta publicación, ha sido obtenida por fuentes confiables y oficiales, consideramos que es correcta, sin embargo no asumimos ninguna responsabilidad por errores, cambios, omisiones o daños que resultaran de estos.



# Cables de Acelerador / Accelerator Cables



NUMERO DE PARTE PART NUMBER	NUMERO DE CLIENTE CUSTOMER NUMBER	AÑO / YEAR	VEHICULO / VEHICLE	LONG. A
VW-108	171723555C	81-87	ACEL. CARIBE AUT. PEDAL A LA CAJA	1000
VW-113	191723555	86-91	ACEL. GOLF JETTA AUTOMATICO DEL PEDAL A LA CAJA	1040



VW-109	010321309 /E	81-87	ACEL. CARIBE AUT. DE LA CAJA AL CARBURADOR	1235
--------	--------------	-------	--	------

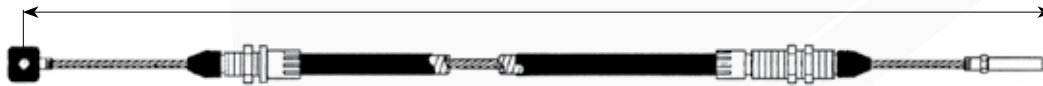

VW-111	321721555A	84-87	ACEL. CORSAR STD.	885
--------	------------	-------	-------------------	-----



VW-112	BAC721555	88-92	ACEL. COMBI ENFRIADA POR AGUA M-1800	4200
VW-134	BAC721555A	93-96	ACEL. COMBI PANEL	4310



VW-114	010321309K	86-91	ACEL. GOLF JETTA AUT. CARBURADOR A LA CAJA	1115
VW-139	089321309J	84-88	ACEL. CORSAR AUTOMATICO DE LA CAJA AL CARBURADOR	1375
VW144	089 321 307 W	91-	ACEL. JETTA F. INJ. FBU 1.8L AUTOMATICO DE LA CAJA AL CARBURADOR	1219

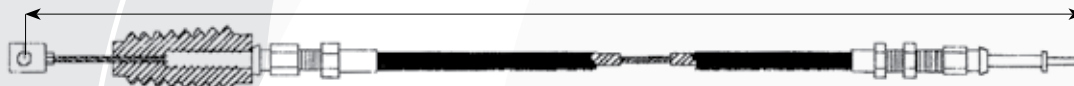

VW-115	133721555B		ACEL. VOLKSWAGEN SEDAN TIPO I Y KAHER (USA)	2611
--------	------------	--	---	------



Importante: La información indicada en esta publicación, ha sido obtenida por fuentes confiables y oficiales, consideramos que es correcta, sin embargo no asumimos ninguna responsabilidad por errores, cambios, omisiones o daños que resulten de estos.

NUMERO DE PARTE PART NUMBER	NUMERO DE CLIENTE CUSTOMER NUMBER	AÑO / YEAR	VEHICULO / VEHICLE	LONG. A
VW-117	811723555A		ACEL. CORSAR AUT.DE LA CAJA AL CARBURADOR	477



VW-119	BAC721555A	94-2002	ACEL.COMBI MOTOR 1800 FUEL INJECTION	4197
--------	------------	---------	--------------------------------------	------

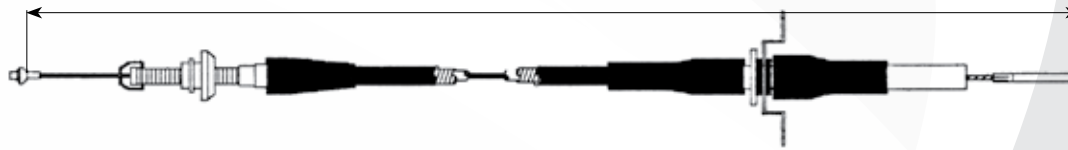

VW-131	532721555B/C	78	ACEL. SCIROCCO	965
--------	--------------	----	----------------	-----



VW-132	1H0721555G	93-2000	ACEL. GOLF JETTA TIPO A3 (EXPORTACION)	942
--------	------------	---------	--	-----

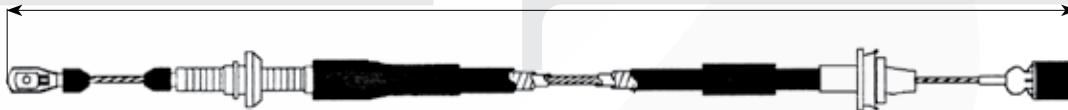

VW-133	1H0721555D	93-2000	ACEL. GOLF JETTA TIPO A3	1237
--------	------------	---------	--------------------------	------



VW-135	6N1721555A	95-98	ACEL. DERBY TIPO S4	1175
--------	------------	-------	---------------------	------



"Importante: La información indicada en esta publicación, ha sido obtenida por fuentes confiables y oficiales, consideramos que es correcta, sin embargo no asumimos ninguna responsabilidad por errores, cambios, omisiones o daños que resultaran de estos".

Cables de Acelerador / Accelerator Cables



# Cables de Acelerador / Accelerator Cables



NUMERO DE PARTE PART NUMBER	NUMERO DE CLIENTE CUSTOMER NUMBER	AÑO / YEAR	VEHICULO / VEHICLE	LONG. A
VW-138	377721555N	98-2000	ACEL. POINTER	993

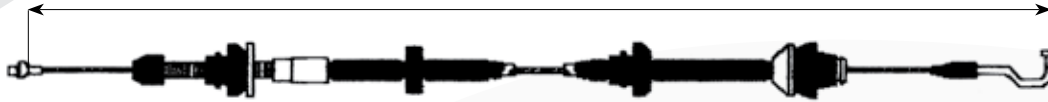

VW-140	1J1721555Q	2001-03	ACEL. JETTA / GOLF A4	1752
	12/2000-		ACEL. BORA 2.0 MECÁNICO	
	3/2000-		ACEL. GOLF 1.8 TURBO 20V	
	8/99-		ACEL. GOLF 2.0 8V	



VW-142	1H0 721 555 R	94	ACEL. PASSAT	1232
		97-99	ACEL. GOLF / JETTA	



VW-143	1J0 721 555 T	8/98-	ACEL. GOLF 1.6L 8 V (98-)	1735
		5/99-	ACEL. AUDI A3	

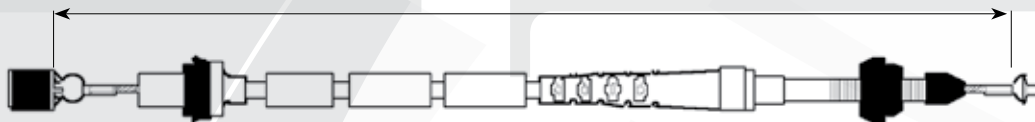

VW-145	377 721 555B	98-01	ACELERADOR POINTER 2.0 L	1040
--------	--------------	-------	--------------------------	------



VW-146	111-721-555 C	-1966	ACCELERATOR CABLE SEDAN I TYPE 1 (EXPORTACION)	2650
VW-147	211-721-555 A	-1964	ACCELERATOR CABLE KOMBI T YPE 2 (EXPORTACION)	3564
VW-148	211-721-555 C	65-68	ACCELERATOR CABLE TRANSPORTER TYPE 2 (EXPORT)	3576



Importante: La información indicada en esta publicación, ha sido obtenida por fuentes confiables y oficiales, consideramos que es correcta, sin embargo no asumimos ninguna responsabilidad por errores, cambios, omisiones o daños que resulten de estos.

Cables de Acelerador / Accelerator Cables

NUMERO DE PARTE PART NUMBER	NUMERO DE CLIENTE CUSTOMER NUMBER	AÑO / YEAR	VEHICULO / VEHICLE	LONG. A
VW-149	211-721-555G	69-71	ACCELERATOR CABLE TRANSPORTER TYPE 2 (EXPORT)	3675

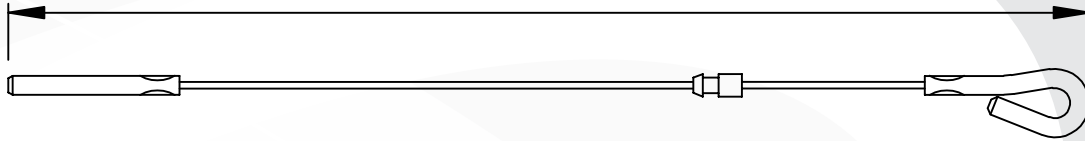

VW-160	TJG 721 555 250 721 555C	91-00	VOLKSWAGEN C.O CABLE DE ACELERADOR CAMION 14220, 16220, 16220 LEITO 24220 CAMION 16170-91... 93, CAMION 16220 (CHILE)-91... 95	1685
--------	-----------------------------	-------	--	------

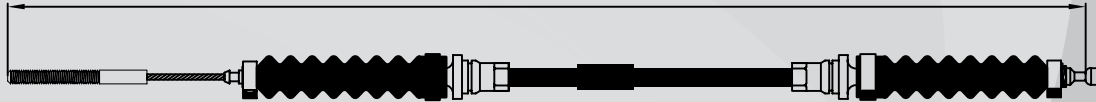

**PRODUCTO NUEVO**

VW-161	2U0 721 555C 2RG 721 555A	95-00	VOLKSWAGEN CAMION 16220 / 16220 LEITO (CHILE) 95... 00, CAMION 16300 / 24250 / 35300 / LEITO 95... 99	1799
--------	------------------------------	-------	---	------

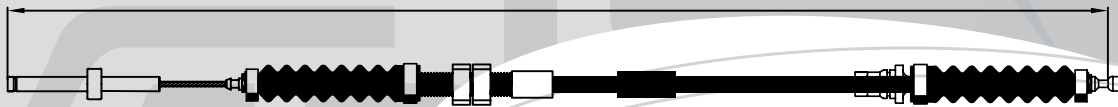

**PRODUCTO NUEVO**

## Cables de Sobre Marcha / Detent Cable



NUMERO DE PARTE PART NUMBER	NUMERO DE CLIENTE CUSTOMER NUMBER	AÑO / YEAR	VEHICULO / VEHICLE	LONG. A
CH-146	4275912	1982-	SOBREMARCHA MODELOS K TRANS. AUT.	972



CH-148	04405158	93-00	SOBREMARCHA SK TODOS, VOYAGER 1993, SL VOYAGER I-MADERA, SD VOYAGER 2-TONOD, SY VOYAGER TOWN COUNTRY & SM VOYAGER SPORT	605
--------	----------	-------	--	-----

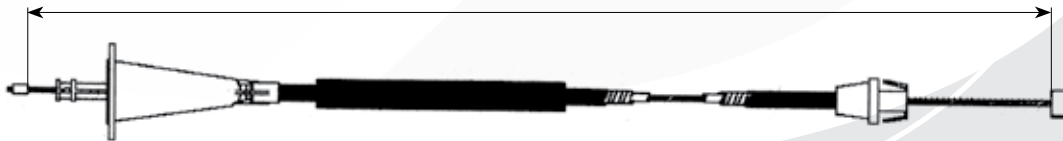

CH-149	52077872	93-2000	SOBREMARCHA GRAN CHEROKEE MOTOR 8 CIL.	810
CH-150		81	SOBREMARCHA DURANGO XLT 4X4	680

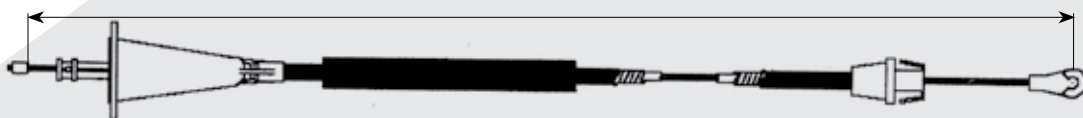

"Importante: La información indicada en esta publicación, ha sido obtenida por fuentes confiables y oficiales, consideramos que es correcta, sin embargo no asumimos ninguna responsabilidad por errores, cambios, omisiones o daños que resultaran de estos".

Cables de Sobre Marcha / Detent Cable

NUMERO DE PARTE PART NUMBER	NUMERO DE CLIENTE CUSTOMER NUMBER	AÑO / YEAR	VEHICULO / VEHICLE	LONG. A
CH-153		93	SOBREMARCHA DODGE VAN (USA)	1990

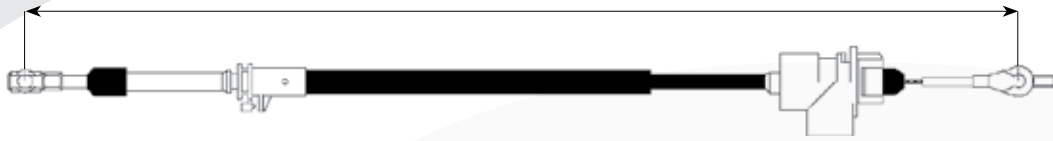

CH-155	4612308	-96	SOBREMARCHA CARAVAN AUTOMATICA, 6 CIL.	480
--------	---------	-----	--	-----

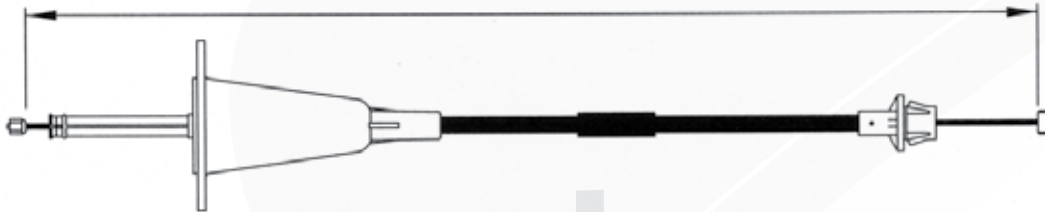

CH-803	4288082	82-89	SOBREMARCHA DART E LEBARON NEW YORKER (AUTOMATICO)	1027
--------	---------	-------	--	------



NUMERO DE PARTE PART NUMBER	NUMERO DE CLIENTE CUSTOMER NUMBER	AÑO / YEAR	VEHICULO / VEHICLE	LONG. A
FO-135	E6DZ7F642A	86-96	SOBREMARCHA TAURUS 3.0L	515
	E7DZ-7F042A	86-96	SOBREMARCHA LINCOLN CONTINENTAL AXOD/AXOD-E & AX4N 3.0L	
FO-136	E8DZF042B	88-96	SOBREMARCHA TAURUS, SABLE, AXOD/AXOD-E& AX4N 3.0L LINCOLN CONTINENTAL AXOD/AXOD-E& AX4N 3.0L	1233
	88-94		SOBREMARCHA LINCOLN CONTINENTAL AXOD/AXOD-E& AX4N 3.0L	



FO-147	1990		SOBREMARCHA AEROSTAR (AMERICANA)	1250
--------	------	--	----------------------------------	------



Importante: La información indicada en esta publicación, ha sido obtenida por fuentes confiables y oficiales, consideramos que es correcta, sin embargo no asumimos ninguna responsabilidad por errores, cambios, omisiones o daños que resulten de estos.

Cables de Sobre Marcha / Detent Cable

NUMERO DE PARTE PART NUMBER	NUMERO DE CLIENTE CUSTOMER NUMBER	AÑO / YEAR	VEHICULO / VEHICLE	LONG. A
GM-127	25510971	82-86	SOBREMARCHA CENTURY DIESEL, EL CAMINO, MONTECARLO, CUTLASS CIERA, SUPREME, 98 REGENCY Y GRAND AM (No. Orig. T0038118)	780
GM-140	25519347		SOBREMARCHA GENERAL MOTORS TRANSMISION AUTOMATICA	1135
GM-143	25521267	85-87	SOBREMARCHA CAPRICE & IMPALA, CABALLERO, BONNEVILLE, GRAND PRIX TRANS AUT	790
GM-144	25515600	82-84	SOBREMARCHA CAMIONETA C100/200/250, VANS G100/150/200/300/350 K100/150 4X4, BLAZER&SUBURBANS TRANS AUT(No. Orig.25507542)	1196
GM-145	1644356	85-87	SOBREMARCHA DEVILLE, CAMARO & BERLINETA TRANS. AUTOMATICA	579
GM-148	25515598	83-87	SOBREMARCHA CAPRICE, IMPALA, CAMARO, BERLINETTA, BLAZER, SUBURBAN	1196
GM-151	25513393	82-83	SOBREMARCHA CENTURY ENG. 2.5R, TRANS TH125; OMEGA ENG. 2.5R	1215
			TODAS & MOD1984 CON TRANS TH125	
		85-92	SOBREMARCHA CAMARO ENG. 2.8S, 3.1T	
		84-86	SOBREMARCHA CELEBRITY ENG. 2.5R TRANS TH125	
		82-92	SOBREMARCHA CIERA ENG. 2.5R TODAS LAS TRANS.	
		85-92	SOBREMARCHA FIREBIRD ENG. 2.8S & 3.1T	
		82-85	SOBREMARCHA CITATION, SKYLARK ENG. 2.5R TODAS LAS TRANS, & 6000; ENG. 2.5R TRANS TH125	
			INCLUYE MOD. 1986	
		84-85	SOBREMARCHA REGAL ENG 231-9 TRANS TH-200-4R	
GM-154	25508262	85-89	SOBREMARCHA SKYLARK W/THM200 A.T. ESTATE WAGON, REGAL LESABRE, ELECTRA WAGON W/THM 200-4R AUTOMATIC TRANSM.	895
GM-160	10066475	1988-	SOBREMARCHA CAPRICE V8 305 TRANS AUT. CAMARO w/THM700	1054
GM-172	1260508	79-	SOBREMARCHA 700	923
GM-173	25513393	82-	SOBREMARCHA TH-125	1118
GM-181	1262487	80-86	SOBREMARCHA CENTURY 82-86, SKYLARK 80-85, CITATION 80-85, CELEBRITY 82-86, CUTLASS CIERA 82-86, OMEGA 80-84, V6 173X, Z (2.8L)	1229
GM-184	10085340	91-94	SOBREMARCHA CAVALIER RS/Z24 V6 3.1 L 189 cid GAS FI N Engine VIN:T	1416



GM-129	1262652	77-80	SOBREMARCHA CENTURY & REGAL, LESABRE, DEVILLE, EL CAMINO, MALIBU, MONTECARLO, MONZA, CABALLERO, CUTLASS FIREBIRD TRANS AUT.	889
GM-135	22503382	1980	SOBREMARCHA CUTLASS, CUSTOM CRUISER, DELTA 88, BONEVILLE TRANS AUT.	960



GM-130	1262620	75-80	SOBREMARCHA CENTURY & REGAL, CAPRICE, IMPALA, MALIBU, NOVA C10 BLAZER, CUTLASS, MONTECARLO TRANS AUTOMATICA	1100
--------	---------	-------	---	------

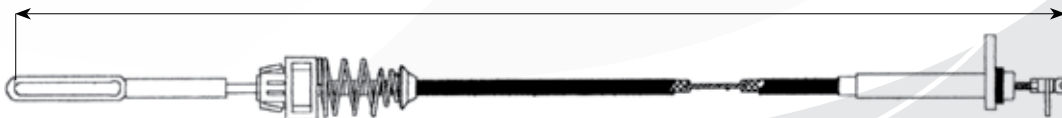

GM-136	1253966	76-77	SOBREMARCHA MONZA, NOVA, CUTLASS(77), OMEGA, PHOENIX, VENTURA	909
--------	---------	-------	---	-----

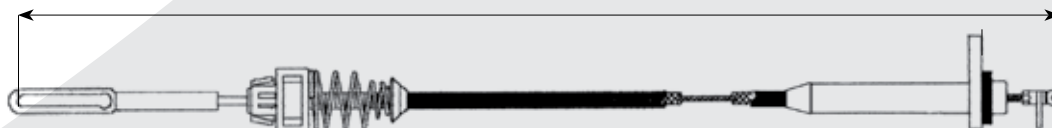

\*Importante: La información indicada en esta publicación, ha sido obtenida por fuentes confiables y oficiales, consideramos que es correcta, sin embargo no asumimos ninguna responsabilidad por errores, cambios, omisiones o daños que resultaran de estos.\*

Cables de Sobre Marcha / Detent Cable



# Cables de Sobre Marcha / Detent Cable



NUMERO DE PARTE PART NUMBER	NUMERO DE CLIENTE CUSTOMER NUMBER	AÑO / YEAR	VEHICULO / VEHICLE	LONG. A
GM-138	1256301	76-79	SOBREMARCHA OMEGA & SKYHAW, FIREBIRD, PHOENIX, Y VENTURA TRANS AUT.	930
GM-158	342486	73-77	SOBREMARCHA APOLO & SKYLARK W/THM350 1973-75 L6 250 NOVA W/THM350 (EXC. INTEGRAL CYL. HEAD) 1976 L6 250, C&K 100-200 SERIES TRUKS & BLAZERS W/AUTO TRANS 1973-74, 1976 L6 250,292, C100-150-250 SERIES TRUCKS W/HD CHASIS & THM350 1976-77 L6 250 (4.1 L) C&K 100-250 SERIES TRUCKS & JIMMY'S W/AUTO TRANS. 1973-74 L6 250-292	1011
GM-159	1262618	76-79	SOBREMARCHA OMEGA AND ALL MODELS W/THM350 & INTEGRATED CYL. HEAD 1976-1977 L6 250 (4L) CAMARO, CAPRICE, IMPALA W/THM350 1978-1979 L6 250 (4L) BLAZER W/THM350 1977-78 L6 292,250 (4.1L), C&K 100-300 & G100-300 TRUCKS & VANS W/THM350 1978 L6 292	1097
GM-161	1262622	77-78	SOBREMARCHA CENTURY, ELECTRA/ PARK AVENUE, REGAL, RIVIERA/ REATA, 98 REGENCY (TODOS EXC ENG. 231) ENG. 350-R 403 TRANS TH-350	950
		77-79	SOBREMARCHA LE SABRE (RWD) ESTATE WAGON/CENTURION; BONEVILLE, CATALINA ENG 350-R, 403; CUTLASS (77) ENG 350, CUTLASS ENG 260, 403; DELTA/CUSTOM CRUISER (RWD) TODOS (EXC 231 & DIESEL) ENG. 260, 350-R; OMEGA GRAN PRIX, LE MANS; PHOENIX (77) ENG 350-R, TRANS TH-350	



GM-139	25507541	81-83	SOBREMARCHA EL CAMINO, MALIBU, MONTECARLO, CAMIONETA C&K150/350 TRANS. AUT.	930
GM-174		81	SOBREMARCHA CHEVROLET PICK UP AMERICANA 6 CIL. 3/4 TON	1050



GM-150	1260508	78-80	SOMBREMARCHA EL DORADO, CAMARO, CABALLERO, CUTLASS, LE MANS, GRAN LEMANS	835
--------	---------	-------	---	-----

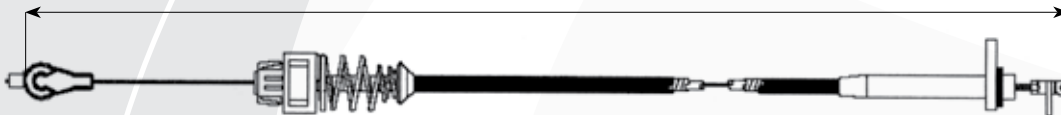

GM-155	94648860	85-87	SOBREMARCHA CHEVROLET CAJA AL CARBURADOR CHEVETTE	1121
GM-156	52281204	88	SOBREMARCHA CHEVROLET CAJA AL CARBURADOR CHEVETTE	1210

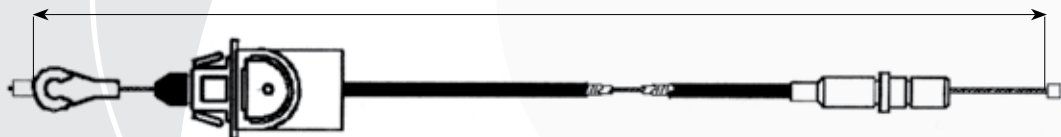

"Importante: La información indicada en esta publicación, ha sido obtenida por fuentes confiables y oficiales, consideramos que es correcta, sin embargo no asumimos ninguna responsabilidad por errores, cambios, omisiones o daños que resulten de estos."

NUMERO DE PARTE PART NUMBER	NUMERO DE CLIENTE CUSTOMER NUMBER	AÑO / YEAR	VEHICULO / VEHICLE	LONG. A
GM-169			SOBREMARCHA UNIVERSAL BUICK, CADILLAC, CHEVROLET & PONTIAC TRANSMISION THM 700R4, TH125, 700, 200	1250

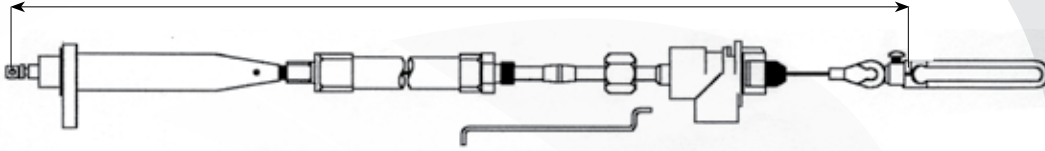

GM-171			SOBREMARCHA UNIVERSAL BUIK CADILLAC, CHEVROLET & PONTIAC TRANSMISION THM 350	1250
--------	--	--	---	------

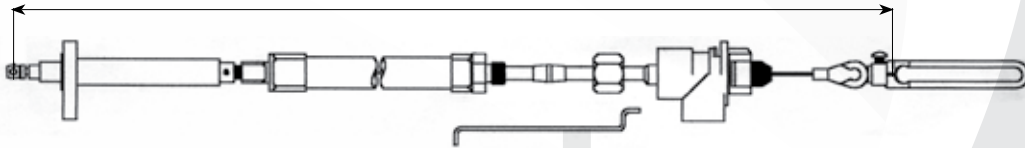

GM-175	96040796	1994	SOBREMARCHA 94 LL V (POSTAL VEHICLE) L4 2.2L 134 cid GAS F. INJ. ENGINE VIN=4 (EXPORTACION)	1387
--------	----------	------	--	------



GM-176	96040480	87-93	SOBREMARCHA LL V (POSTAL VEHICLE) L4 2.5L 2474 cc 155 cid GAS F. INJ. ENGINE VIN=A (EXPORTACION)	755
--------	----------	-------	---	-----



NUMERO DE PARTE PART NUMBER	NUMERO DE CLIENTE CUSTOMER NUMBER	AÑO / YEAR	VEHICULO / VEHICLE	LONG. A
NI143		84-85	SOBREMARCHA TSURU I 4 CIL	1080
NI144		86-87/90	SOBREMARCHA TSURU I 4 CIL, TSURU II 4 CIL	1135
NI145		84-85	SOBREMARCHA TSURU I 4 CIL	1250
NI146			SOBREMARCHA TSURU AUTOMATICO 4 CIL	1180

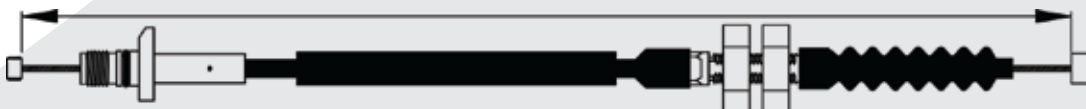

\*Importante: La información indicada en esta publicación, ha sido obtenida por fuentes confiables y oficiales, consideramos que es correcta, sin embargo no asumimos ninguna responsabilidad por errores, cambios, omisiones o daños que resultaran de estos.\*

Cables de Sobre Marcha / Detent Cable

NUMERO DE PARTE PART NUMBER	NUMERO DE CLIENTE CUSTOMER NUMBER	AÑO / YEAR	VEHICULO / VEHICLE	LONG. A
CH-300	4369592 4188656	82-83	EMBRAGUE DART VOLARE DART K (CORTO)	1050



CH-301	4369591	84-86	EMBRAGUE DART VOLARE K (LARGO)	1090
CH-302	4505341	89-	EMBRAGUE SHADOW	1085



CH-304	MB012475	79-86	EMBRAGUE D50 ARROW PICK UP W/4WD L4 (2.6 L)W PICK UP PLYMOUTH	797
--------	----------	-------	---	-----



CH-305	MB012460	79-86	EMBRAGUE RAM D50 ARROW PICK UP W/2WD L4 2.0 & 2.6 W	825
--------	----------	-------	---	-----

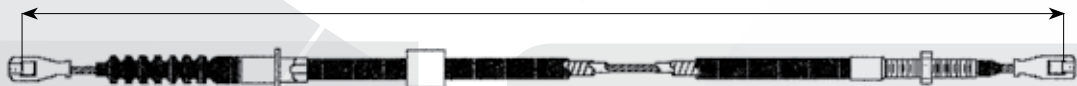

CH-306	4670400	95-99	EMBRAGUE NEON	817
CH-307	4593333	95-99	EMBRAGUE STRATUS	760



CH-308	04578930AA	01-04	C. EMBRAGUE AUTO AJUSTABLE DODGE STRATUS	778
--------	------------	-------	--	-----



Importante: La información indicada en esta publicación, ha sido obtenida por fuentes confiables y oficiales, consideramos que es correcta, sin embargo no asumimos ninguna responsabilidad por errores, cambios, omisiones o daños que resulten de estos.

NUMERO DE PARTE PART NUMBER	NUMERO DE CLIENTE CUSTOMER NUMBER	AÑO / YEAR	VEHICULO / VEHICLE	LONG. A
CH-309	04668999AC	00-02	C. EMBRAGUE AUTO AJUSTABLE DODGE NEON	840



HY-303	4151002010	2000	EMBRAGUE ATOS MOTOR 1.1 (5071234AA)	820
--------	------------	------	-------------------------------------	-----



NUMERO DE PARTE PART NUMBER	NUMERO DE CLIENTE CUSTOMER NUMBER	AÑO / YEAR	VEHICULO / VEHICLE	LONG. A
DW-300	90209335		EMBRAGUE DAEWOO	815



DW-301	96336061	04-	EMBRAGUE PONTIAC MATIZ MOTOR 1.0L MFI 4 CIL. OHC	850
--------	----------	-----	--	-----



DW-302	96590793	2006	C. EMBRAGUE PONTIAC MATIZ	824
--------	----------	------	---------------------------	-----



DW-303	23710-A78B10-00		C. DE EMBRAGUE DAEWOO DW TICO DAMAS	715
--------	-----------------	--	-------------------------------------	-----

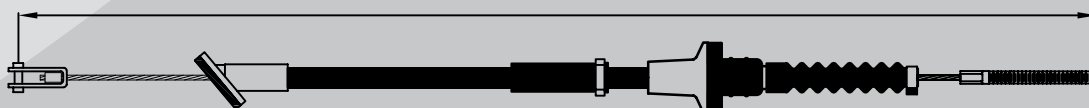

**PRODUCTO NUEVO**

\*Importante: La información indicada en esta publicación, ha sido obtenida por fuentes confiables y oficiales, consideramos que es correcta, sin embargo no asumimos ninguna responsabilidad por errores, cambios, omisiones o daños que resultaran de estos.\*

Cables de Embrague / Clutch Cable



NUMERO DE PARTE PART NUMBER	NUMERO DE CLIENTE CUSTOMER NUMBER	AÑO / YEAR	VEHICULO / VEHICLE	LONG. A
DH-300	3134087711	TODOS	EMBRAGUE CHARADE 620	628

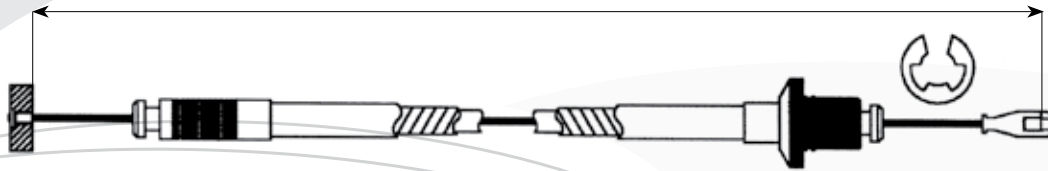

NUMERO DE PARTE PART NUMBER	NUMERO DE CLIENTE CUSTOMER NUMBER	AÑO / YEAR	VEHICULO / VEHICLE	LONG. A
DI-300	A12183C35		EMBRAGUE DINA 531/631	790
DI-301	3231395		EMBRAGUE DINA 1000/3000	605
DI-302	A35183-35		EMBRAGUE DINA 3200	505



DI-303		TODOS	EMBRAGUE CAMION DINA 155/210	840
--------	--	-------	------------------------------	-----

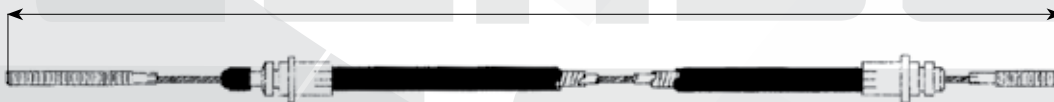

DI-304	2995651C91	96-99	EMB. CAMION DINA, MICROBUS MAQUINA CUMMINS SERIE 160	2500
--------	------------	-------	--	------



DI-305	298C110030	05-	EMBRAGUE UNIDAD URBANA MODELO 554 MOTOR TRASERO CUMMINS ISB 225 hp@2300 rpm TRANSMISIÓN FULLER DE 6 VELOCIDADES	1270
DI-306	298C110040	05-	EMBRAGUE UNIDAD URBANA MODELO 554 MOTOR DELANTERO CUMMINS ISB 225 hp@2300 rpm TRANSMISIÓN FULLER DE 6 VELOCIDADES	2235



Importante: La información indicada en esta publicación, ha sido obtenida por fuentes confiables y oficiales, consideramos que es correcta, sin embargo no asumimos ninguna responsabilidad por errores, cambios, omisiones o daños que resulten de estos.

Cables de Embrague / Clutch Cable

NUMERO DE PARTE PART NUMBER	NUMERO DE CLIENTE CUSTOMER NUMBER	AÑO / YEAR	VEHICULO / VEHICLE	LONG. A
FO-300	79B4-7K553-AB	79-84	EMBRAGUE FAIRMONT-MUSTANG	1300



FO-301	EA3C-7K553-AA79	85-86	EMBRAGUE TOPAZ	645
--------	-----------------	-------	----------------	-----

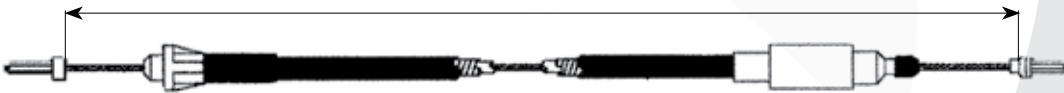

FO-302	85ZY-7K553-AIE	85-91	EMBRAGUE THUNDERBIRD	1470
--------	----------------	-------	----------------------	------

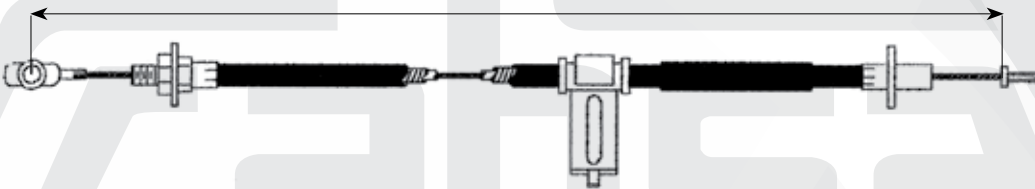

FO-303		86	EMBRAGUE TOPAZ PLASTICO	645
--------	--	----	-------------------------	-----



FO-304	83ZY-7K553-AB		EMBRAGUE FAIRMONT 6 CIL.	1350
--------	---------------	--	--------------------------	------



FO-305	8DOM7K553A		EMBRAGUE FORD EL REY, CORCEL (EXPORTACIÓN)	785
--------	------------	--	--	-----

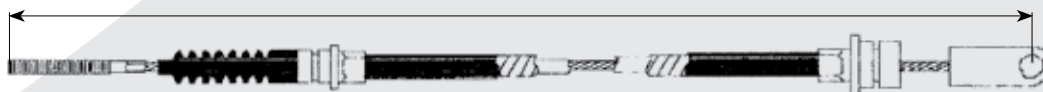

\*Importante: La información indicada en esta publicación, ha sido obtenida por fuentes confiables y oficiales, consideramos que es correcta, sin embargo no asumimos ninguna responsabilidad por errores, cambios, omisiones o daños que resultaran de estos\*.



# Cables de Embrague / Clutch Cable



NUMERO DE PARTE PART NUMBER	NUMERO DE CLIENTE CUSTOMER NUMBER	AÑO / YEAR	VEHICULO / VEHICLE	LONG. A
FT-300	5963181	87-89	EMBRAGUE UNO/PREMIO/ELBA/FIORINO; DUNA; UNO CS; FIORINO BENZ DIESEL-PENNY	640



FT-301	7616775	87-	EMBRAGUE REGATA TURBO D	653
--------	---------	-----	-------------------------	-----

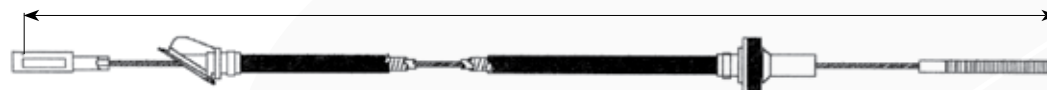

FT-302	7520132	91-93	EMBRAGUE UNO CS-S PREMIO P(BRASIL); FIORINO BENZ DIESEL	622
--------	---------	-------	---	-----

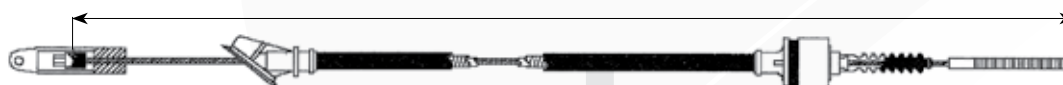

FT-303	7515915	89-	EMBRAGUE DUNA; UNO CS; FIORINO BENZINA E DIESEL	645
--------	---------	-----	---	-----

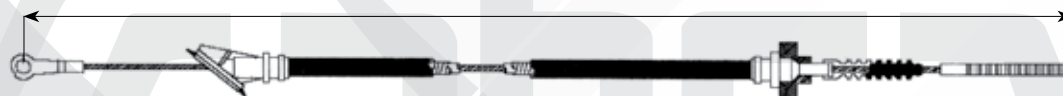

FT-304	5967096	-83	EMBRAGUE RITMO EXC. DIESEL DESDE 82; REGATA	622
--------	---------	-----	---	-----

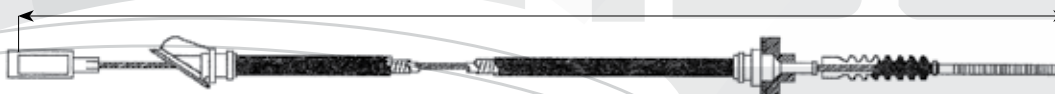

NUMERO DE PARTE PART NUMBER	NUMERO DE CLIENTE CUSTOMER NUMBER	AÑO / YEAR	VEHICULO / VEHICLE	LONG. A
GM-300	2771759		EMBRAGUE OPEL 4 CIL.	885
GM-301	2771457		EMBRAGUE OPEL 6 CIL.	935

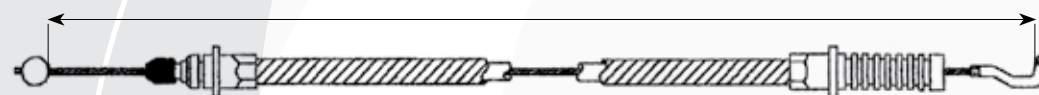

GM-302	669002		EMBRAGUE CUADRO RECORD	880
--------	--------	--	------------------------	-----

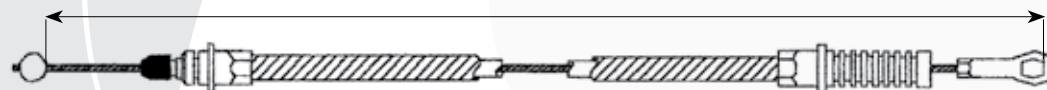

Importante: La información indicada en esta publicación, ha sido obtenida por fuentes confiables y oficiales, consideramos que es correcta, sin embargo no asumimos ninguna responsabilidad por errores, cambios, omisiones o daños que resulten de estos.

Cables de Embrague / Clutch Cable

NUMERO DE PARTE PART NUMBER	NUMERO DE CLIENTE CUSTOMER NUMBER	AÑO / YEAR	VEHICULO / VEHICLE	LONG. A
GM-303	14056660	85-86	EMBRAGUE CELEBRITY	840
GM-304	14056659	82-84	EMBRAGUE CELEBRITY	850
GM-305		85-86	EMBRAGUE CITATION	860
GM-306		82-84	EMBRAGUE CITATION	860

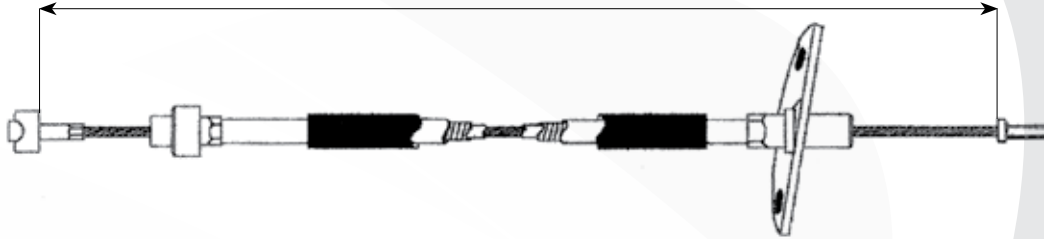

GM-307	90446929	94-96	EMBRAGUE CHEVY CORSA	726
GM-311	94638953	82-5/93	EMBRAGUE MONZA (EXPORTACIÓN)	790



GM-308	90522447	96-	EMBRAGUE CHEVY CORSA	794
--------	----------	-----	----------------------	-----



GM-309	9606189	96-2000	EMBRAGUE CHEVROLET	1152
--------	---------	---------	--------------------	------



GM-310	94600182	1973-	EMBRAGUE CHEVETTE	1140
--------	----------	-------	-------------------	------



GM-312	94638953		EMBRAGUE MONZA (BRASIL) (EXPORTACIÓN)	803
GM-313	93201971		EMBRAGUE MONZA (BRASIL) (EXPORTACIÓN)	845



GM-314		1982	EMBRAGUE S10 603 & PICK UP	430
--------	--	------	----------------------------	-----

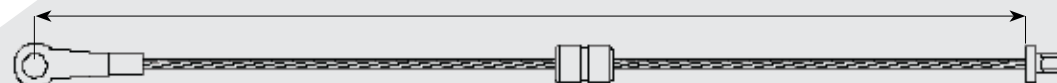

\*Importante: La información indicada en esta publicación, ha sido obtenida por fuentes confiables y oficiales, consideramos que es correcta, sin embargo no asumimos ninguna responsabilidad por errores, cambios, omisiones o daños que resultaran de estos.\*



# Cables de Embrague / Clutch Cable



NUMERO DE PARTE PART NUMBER	NUMERO DE CLIENTE CUSTOMER NUMBER	AÑO / YEAR	VEHICULO / VEHICLE	LONG. A
GM315			CABLE PARA EMBRAGUE S10	200

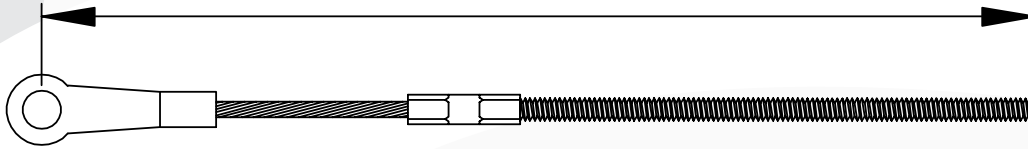

GM-316		2011-	C. EMBRAGUE SPARK 1.2 L	930
--------	--	-------	-------------------------	-----

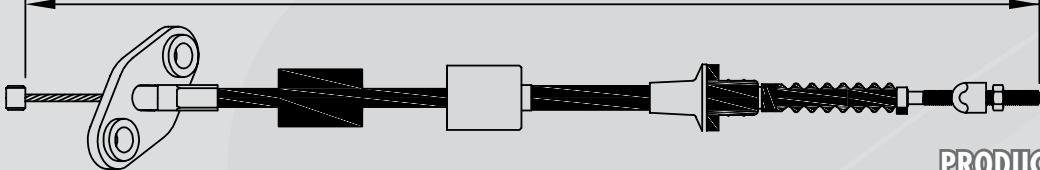

**PRODUCTO NUEVO**

GM-317	23710-57 B12	92-98	C. DE EMBRAGUE GEO TRACKER 16 VALVULAS 1.6 L	1876
--------	--------------	-------	--	------

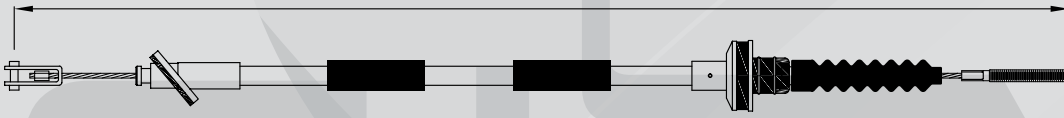

**PRODUCTO NUEVO**

DW-301	96336061	04-	EMBRAGUE PONTIAC MATIZ MOTOR 1.0L MFI 4 CIL. OHC	850
--------	----------	-----	--	-----



DW-302	96590793	2006	C. EMBRAGUE PONTIAC MATIZ	824
--------	----------	------	---------------------------	-----

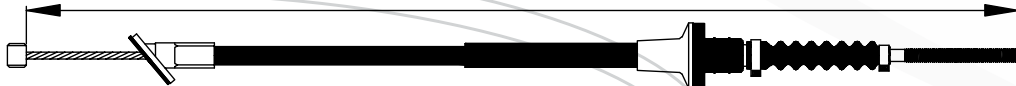

NUMERO DE PARTE PART NUMBER	NUMERO DE CLIENTE CUSTOMER NUMBER	AÑO / YEAR	VEHICULO / VEHICLE	LONG. A
HN-300	22910.SEO.A01	1986-89	EMBRAGUE ACCORD	1930

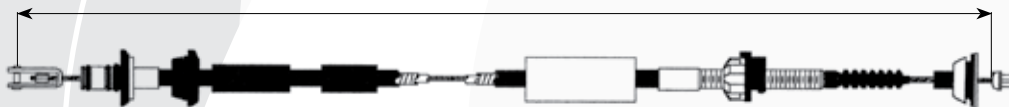

HN-301	22910.SAO.674	1983	EMBRAGUE CIVIC	1474
--------	---------------	------	----------------	------



Importante: La información indicada en esta publicación, ha sido obtenida por fuentes confiables y oficiales, consideramos que es correcta, sin embargo no asumimos ninguna responsabilidad por errores, cambios, omisiones o daños que resulten de estos.

Cables de Embrague / Clutch Cable

NUMERO DE PARTE PART NUMBER	NUMERO DE CLIENTE CUSTOMER NUMBER	AÑO / YEAR	VEHICULO / VEHICLE	LONG. A
HN-302	22910.634.673	1973-79	EMBRAGUE CIVIC 1.2-1250	1286

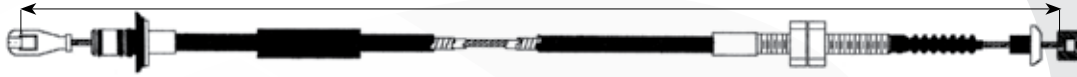

HN-303	22910.SB0.671	1983	EMBRAGUE PRELUDE	1472
--------	---------------	------	------------------	------

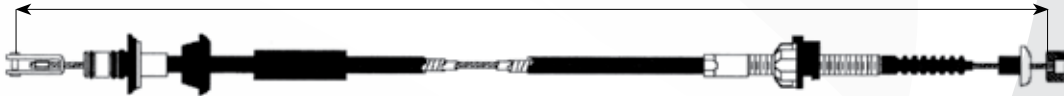

HN-304	22910.657.670	1980-	EMBRAGUE CIVIC 1250	1292
--------	---------------	-------	---------------------	------



HN-305	22910.SA5.672	1985	EMBRAGUE ACCORD (Exc. SEI)	1820
HN-308	22910.SB2.672	1980-87	EMBRAGUE CIVIC 1.5/1.6 (22910.SH3.A01)	1541



HN-306	22910.SH3.A05	1988-90	EMBRAGUE CIVIC	1562
--------	---------------	---------	----------------	------



HN-307	22910.SA4.670/1	1982-84	EMBRAGUE ACCORD	1587
--------	-----------------	---------	-----------------	------

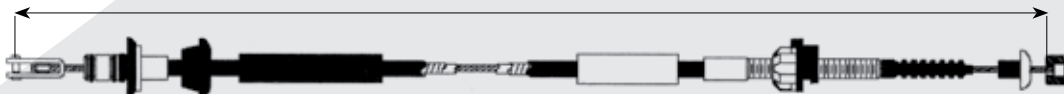

"Importante: La información indicada en esta publicación, ha sido obtenida por fuentes confiables y oficiales, consideramos que es correcta, sin embargo no asumimos ninguna responsabilidad por errores, cambios, omisiones o daños que resultaran de estos".

NUMERO DE PARTE PART NUMBER	NUMERO DE CLIENTE CUSTOMER NUMBER	AÑO / YEAR	VEHICULO / VEHICLE	LONG. A
HY-300	415 1024000	90-94	EMBRAGUE HYUNDAI EXCEL PONY LS	1410



HY-301	415 1024003	90-94	EMBRAGUE EXCEL	1405
HY-302	415 1021002	86-90	EMBRAGUE EXCEL	1273

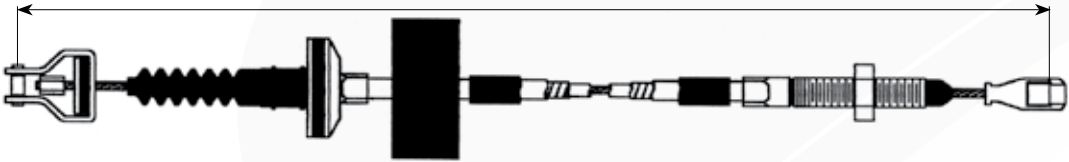

HY-303	4151002010	2000	EMBRAGUE ATOS MOTOR 1.1 (5071234AA)	820
--------	------------	------	-------------------------------------	-----

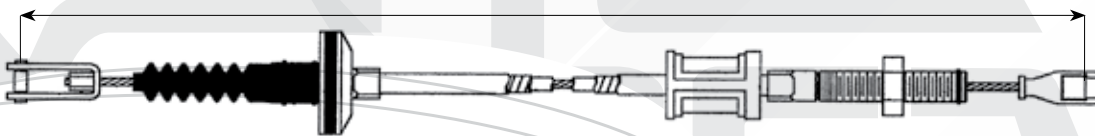

NUMERO DE PARTE PART NUMBER	NUMERO DE CLIENTE CUSTOMER NUMBER	AÑO / YEAR	VEHICULO / VEHICLE	LONG. A
IS-300	8.94460.504.2	1987-90	EMBRAGUE ISUZU TROOPER GAS 2254cc HASTA 2788cc, 4&6 CIL.	1645

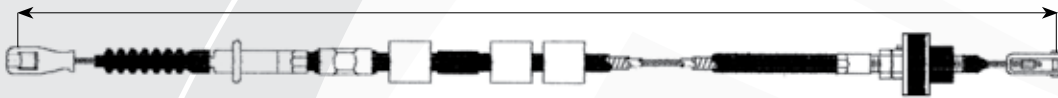

IS-301	8.94467.571.4	1990-	EMBRAGUE ISUZU STORM, ISUZU IMPULSE TURBO	930
IS-303	8.94322.759.1	1985-1989	EMBRAGUE ISUZU/GEO, I-MARK 1.5L EXCEPTO TURBO, 1 CAM 1471cc 4 CIL.	870

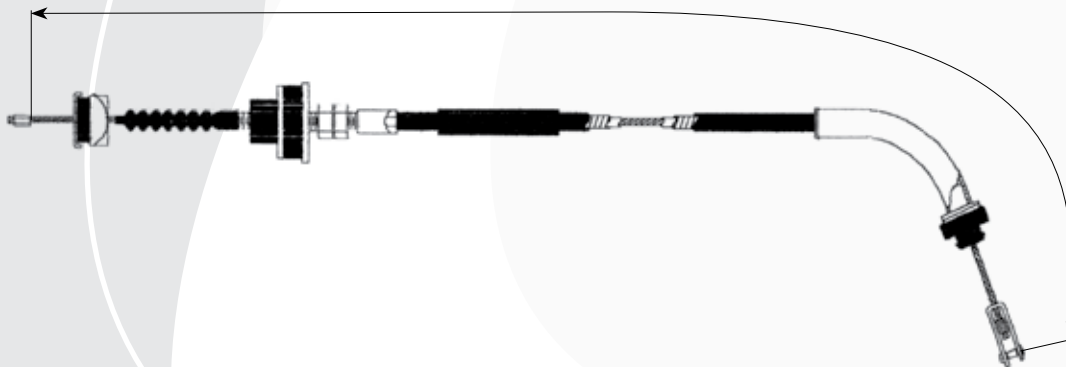

"Importante: La información indicada en esta publicación, ha sido obtenida por fuentes confiables y oficiales, consideramos que es correcta, sin embargo no asumimos ninguna responsabilidad por errores, cambios, omisiones o daños que resulten de estos."

Cables de Embrague / Clutch Cable

NUMERO DE PARTE PART NUMBER	NUMERO DE CLIENTE CUSTOMER NUMBER	AÑO / YEAR	VEHICULO / VEHICLE	LONG. A
IS-302	531425 013 0		EMBRAGUE ISUZU	1360



IS-304	940271 92		EMBRAGUE LUV (94028795)	1542
--------	-----------	--	-------------------------	------

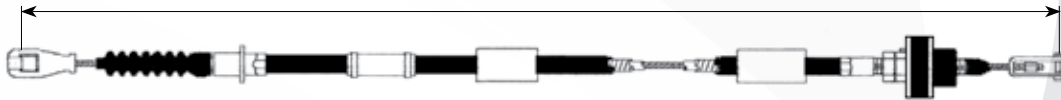

IS-305	8.94207.129.2	1981-84	EMBRAGUE ISUZU I-MARK (GAS) 1.8L 4CIL.	1278
--------	---------------	---------	--	------



IS-306	8.94251.468.1/2 84-11/87	81-82	EMBRAGUE ISUZU, PICK UP & LUV PICK UP GAS ENG PWG STEERING EMBRAGUE GM / GEO LUV P/U DIESEL	1658
--------	-----------------------------	-------	--	------



IS-307	8.942511851	1984-87	EMBRAGUE ISUZU PICK UP GASOL WITHOUT POWER STEERING	1581
--------	-------------	---------	---	------

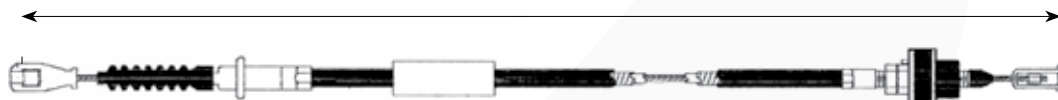

IS-308	8.94334.082.0	88-90	EMBRAGUE ISUZU PICK UP AMIGO 2.3L 2254cc & ENG. CODE 4ZD1 & 2W D 4 CIL	1650
--------	---------------	-------	--	------



IS-309	531425 013 0	-75,89-	EMBRAGUE LUV	1552
--------	--------------	---------	--------------	------



"Importante: La información indicada en esta publicación, ha sido obtenida por fuentes confiables y oficiales, consideramos que es correcta, sin embargo no asumimos ninguna responsabilidad por errores, cambios, omisiones o daños que resultaran de estos".

Cables de Embrague / Clutch Cable



**KIA MOTORS**

# Cables de Embrague / Clutch Cable



NUMERO DE PARTE PART NUMBER	NUMERO DE CLIENTE CUSTOMER NUMBER	AÑO / YEAR	VEHICULO / VEHICLE	LONG. A
KI-300	41510-07120	TODOS	C. DE EMBRAGUE KIA PICANTO	840

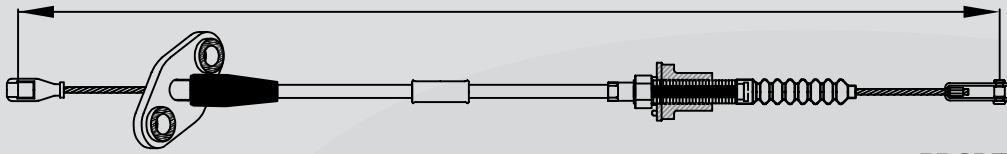

**PRODUCTO NUEVO**

KI-301	KDA0141150F	89-	C. DE EMBRAGUE KIA	687
--------	-------------	-----	--------------------	-----

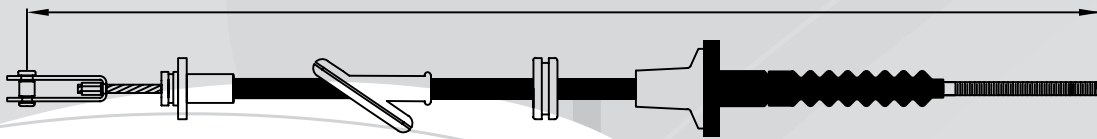

**PRODUCTO NUEVO**

## KODIAK

NUMERO DE PARTE PART NUMBER	NUMERO DE CLIENTE CUSTOMER NUMBER	AÑO / YEAR	VEHICULO / VEHICLE	LONG. A
KD-300	15959 451		EMBRAGUE KODIAK CHEV. 89" y TOP KNICK	2270
KD-302			EMBRAGUE KODIAK CHEVROLET DE 124"	3140
KD-303			CABLE DE EMBRAGUE KODIAK Chev 128"	3255

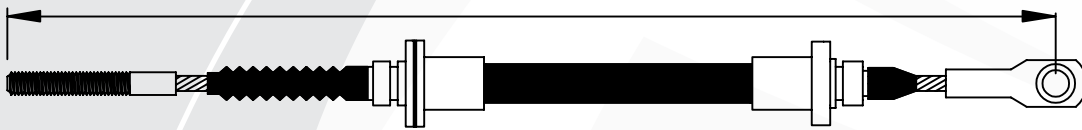

KD-301	15959 453		EMBRAGUE KODIAK CHEV. 101" Y TOP KNICK	2573
--------	-----------	--	--	------



Importante: La información indicada en esta publicación, ha sido obtenida por fuentes confiables y oficiales, consideramos que es correcta, sin embargo no asumimos ninguna responsabilidad por errores, cambios, omisiones o daños que resulten de estos.

Cables de Embrague / Clutch Cable

NUMERO DE PARTE PART NUMBER	NUMERO DE CLIENTE CUSTOMER NUMBER	AÑO / YEAR	VEHICULO / VEHICLE	LONG. A
MZ-300	BF67.41150C	86-89	EMBRAGUE TURBO MERCURY	762
		88-89	EMBRAGUE 323 L4 1.6L 2ND.1586cc-1490cc	



MI-301	GA97.41150D	83-87	EMBRAGUE 626 1979cc HASTA 2000 cc 4 CIL	760
--------	-------------	-------	---	-----

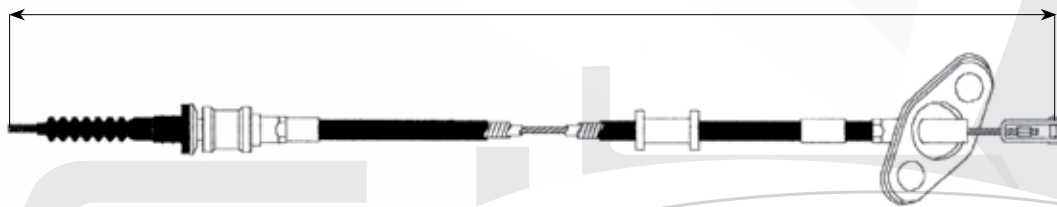

NUMERO DE PARTE PART NUMBER	NUMERO DE CLIENTE CUSTOMER NUMBER	AÑO / YEAR	VEHICULO / VEHICLE	LONG. A
MI-300	MB598411 527073	87-93	EMBRAGUE MITSUBISHI & PLYMOUTH PICK UP	870



MI-301	MB527467	85-88	EMBRAGUE MITSUBISHI TURBO	1392
MI-302	4151021010	86-90	EMBRAGUE EXCEL	1269
		87-89	EMBRAGUE PRECIS L4 1.5L	

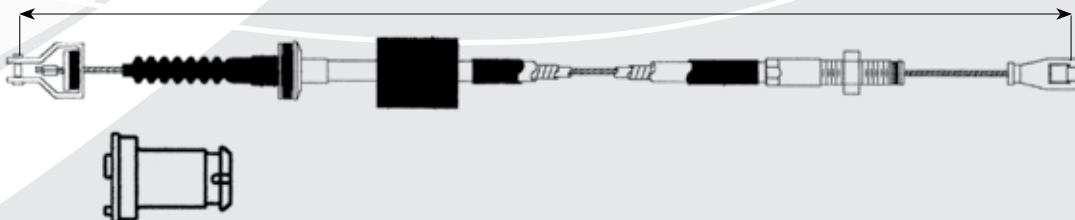

"Importante: La información incluida en esta publicación, ha sido obtenida por fuentes confiables y oficiales, consideramos que es correcta, sin embargo no asumimos ninguna responsabilidad por errores, cambios, omisiones o daños que resultaran de estos".

NUMERO DE PARTE PART NUMBER	NUMERO DE CLIENTE CUSTOMER NUMBER	AÑO / YEAR	VEHICULO / VEHICLE	LONG. A
MI-303	MB012475	1983-86	EMBRAGUE RAM 50& POWER RAM 50, PICK UP W/4WD, EXC DIESEL L4 2.6L ENG 1997cc HASTA 2555cc.	797
MI-307	MB011942	73-78	EMBRAGUE MITSUBISHI LANCER, COLT SEDAN COUPE W/RWD	824



MI-304	MB012460	79-86	EMBRAGUE ARROW & D50 TRANS MANUAL, W/FWD, RAM 50 & POWER RAM 50 TRANS MANUAL, W/RWD, EXC DIESEL PICK UP W/2WD L4, 2.0L 2.6L 1997cc HASTA 2555cc.	825
--------	----------	-------	--	-----

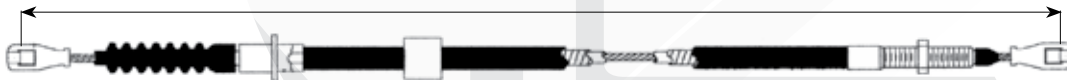

MI-305	MB012071	80-84 86-90	EMBRAGUE MITSUBISHI CHAMP TRANS MANUAL, COLT TRANS MANUAL & AUTOM EMBRAGUE MITSUBISHI EXCEL	1390
--------	----------	----------------	--	------



MI-306		80	EMBRAGUE COLT MIRAGE	1361
--------	--	----	----------------------	------



MI-308	MB527334	88- 88-92	EMBRAGUE DELICA EMBRAGUE LANCER	2042
--------	----------	--------------	------------------------------------	------



Importante: La información indicada en esta publicación, ha sido obtenida por fuentes confiables y oficiales, consideramos que es correcta, sin embargo no asumimos ninguna responsabilidad por errores, cambios, omisiones o daños que resulten de estos.

NUMERO DE PARTE PART NUMBER	NUMERO DE CLIENTE CUSTOMER NUMBER	AÑO / YEAR	VEHICULO / VEHICLE	LONG. A
MB-300	561610R91		MERCEDES BENZ	1490



NUMERO DE PARTE PART NUMBER	NUMERO DE CLIENTE CUSTOMER NUMBER	AÑO / YEAR	VEHICULO / VEHICLE	LONG. A
NI-300	30670-0-4A00	82-87	EMBRAGUE TSURU I PULSAR TODOS LOS MODELOS TRANS MANUAL, SENTRA GAS ENGINE L4 MOTOR E15, E16	705
NI-301	30770-60A-R0	88-92	EMBRAGUE TSURU II SENTRA	800



NI-302	3077062Y01	91-93	EMBRAGUE TSURU, TSUBAME 1.6L	752
NI-303	3077064Y01	91-93	EMBRAGUE TSURU GTS DEPORTIVO, SENTRA 2.0L	727
NI-305	30770 1M200	96-98	EMBRAGUE LUCCINO, SENTRA B12, 16V	710



NI-304	30670-D2801	84-86	EMBRAGUE STANZA ALL MODELS MOTOR CA20E, CA20S L4 UP TO 1/86	1000
--------	-------------	-------	---	------



NI-306	30770 9B400	96-98	EMBRAGUE ALTIMA, MAXIMA B14	740
NI-307	30770 2M105	95-96	EMBRAGUE SENTRA, LUCCINO, ALTIMA, MAXIMA MOTOR B14	742
NI-308	30770 74Y01	92-94	EMBRAGUE TSURU, PULSAR, SUNNY MOTOR B13	740
NI-309	30770 1M200	91-	EMBRAGUE TSURU III, SENTRA 200SX 1.6-2.0 L	741

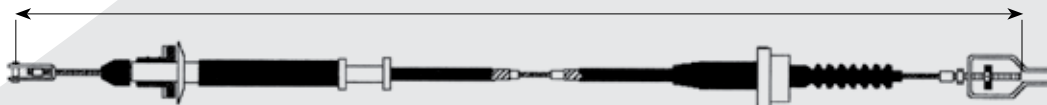

\*Importante: La información indicada en esta publicación, ha sido obtenida por fuentes confiables y oficiales, consideramos que es correcta, sin embargo no asumimos ninguna responsabilidad por errores, cambios, omisiones o daños que resultaran de estos\*.

NUMERO DE PARTE PART NUMBER	NUMERO DE CLIENTE CUSTOMER NUMBER	AÑO / YEAR	VEHICULO / VEHICLE	LONG. A
NI-310		2002-	EMBRAGUE PLATINA STD 1.6L	960

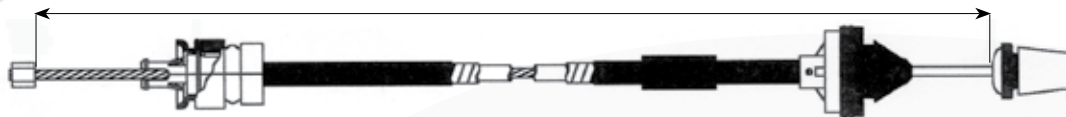

NI-311	30670A03R0	86-88	EMBRAGUE SUNNY TSURU I	700
--------	------------	-------	------------------------	-----



NI-312	30770-F4203	2004-2007	CABLE DE EMBRAGUE TSURU III 16 VALV	752
--------	-------------	-----------	-------------------------------------	-----



NI-350	30670 04A00	82-87	EMBRAGUE TSURU I PULSAR TODOS LOS MODELOS TRANS MANUAL, SENTRA GAS ENGINE L4 MOTOR E15, EIC (EQUIPO ORIGINAL)	705
NI-351	30770 60AR0	88-92	EMBRAGUE TSURU II SENTRA (EQUIPO ORIGINAL)	800



NI-352	30770 62Y01	91-93	EMBRAGUE TSURU, TSUBAME 1.6L (EQUIPO ORIGINAL)	752
NI-353	30776 4Y01	91-93	EMBRAGUE TSURU GTS DEPORTIVO, SENTRA 2.0L (EQUIPO ORIGINAL)	727
NI-354	30770 1M200	96-98	EMBRAGUE SENTRA B12, 16V (EQUIPO ORIGINAL)	710



Importante: La información indicada en esta publicación, ha sido obtenida por fuentes confiables y oficiales, consideramos que es correcta, sin embargo no asumimos ninguna responsabilidad por errores, cambios, omisiones o daños que resulten de estos.

NUMERO DE PARTE PART NUMBER	NUMERO DE CLIENTE CUSTOMER NUMBER	AÑO / YEAR	VEHICULO / VEHICLE	LONG. A
NI-362	30770-F4203	2004-2007	C. EMBRAGUE TSURU III 16- VALV TERMINAL ZAMACK	752



NUMERO DE PARTE PART NUMBER	NUMERO DE CLIENTE CUSTOMER NUMBER	AÑO / YEAR	VEHICULO / VEHICLE	LONG. A
PG-300	2150AX	TODOS	EMBRAGUE PEUGEOT 206	565

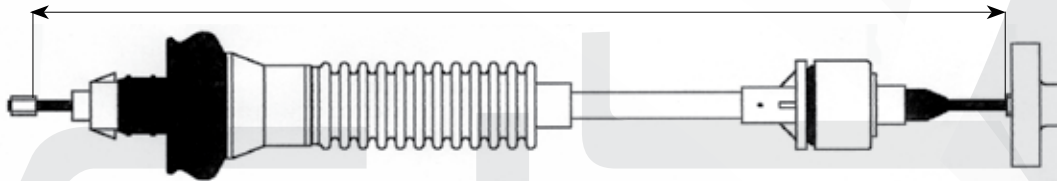

PG-301	2150.CO		EMBRAGUE PEUGEOT 205 GT 1.3L	1275
--------	---------	--	------------------------------	------

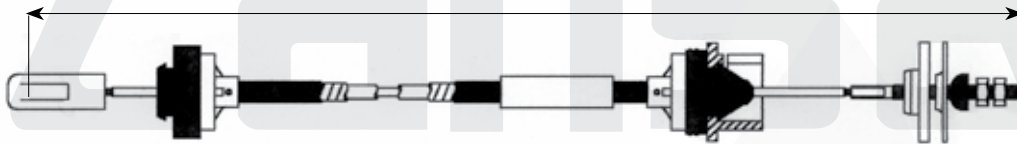

PG-302	2150.79	92-98	EMBRAGUE PEUGEOT 405	1380
--------	---------	-------	----------------------	------

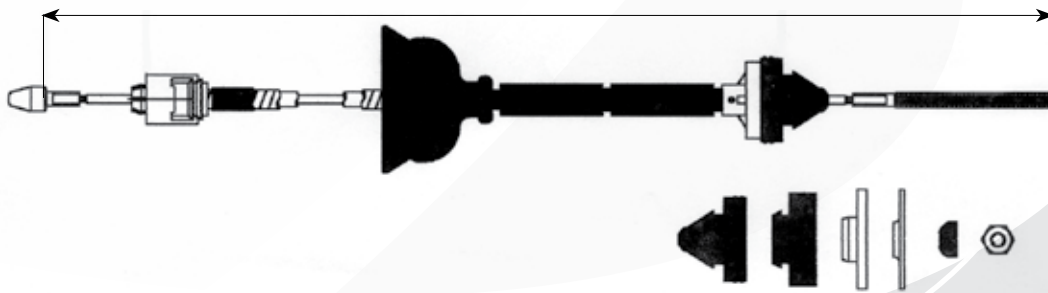

PG-303	2150.CX	TODOS	C. DE EMBRAGUE PEUGEOT PARTNER	898
--------	---------	-------	--------------------------------	-----

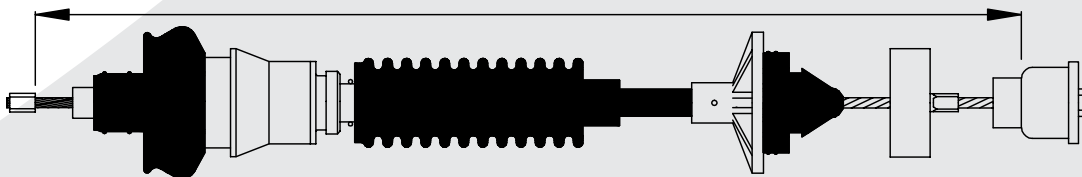

"Importante: La información indicada en esta publicación, ha sido obtenida por fuentes confiables y oficiales, consideramos que es correcta, sin embargo no asumimos ninguna responsabilidad por errores, cambios, omisiones o daños que resultaran de estos".

NUMERO DE PARTE PART NUMBER	NUMERO DE CLIENTE CUSTOMER NUMBER	AÑO / YEAR	VEHICULO / VEHICLE	LONG. A
PG-304	9664708080	TODOS	EMBRAGUE PEUGEOT PARTNER 1.6L	870

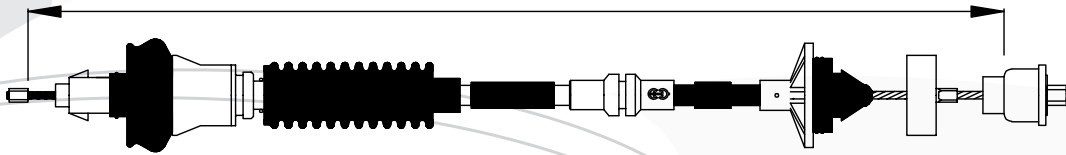

**RENAULT**

NUMERO DE PARTE PART NUMBER	NUMERO DE CLIENTE CUSTOMER NUMBER	AÑO / YEAR	VEHICULO / VEHICLE	LONG. A
RE-300	7700577706		EMBRAGUE R-12 TL (CORTO)	760
RE-301	7701348399		EMBRAGUE R-12 TL (LARGO)	860
RE-308		74-83	EMBRAGUE R-12 TS	620
RE-309	7701348	74-83	EMBRAGUE ROUTIER TL GUAYIN	780



RE-302	7700665849		EMBRAGUE R-5 MIRAGE	620
--------	------------	--	---------------------	-----



RE-303	7700665849		EMBRAGUE R-18	1515
--------	------------	--	---------------	------

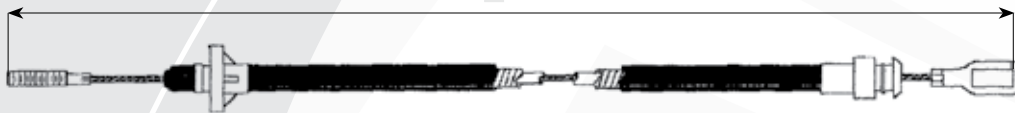

RE-304			EMBRAGUE ESTAFETA	730
--------	--	--	-------------------	-----



RE-305	770053333		EMBRAGUE R-8 R-10	2240
--------	-----------	--	-------------------	------



Importante: La información indicada en esta publicación, ha sido obtenida por fuentes confiables y oficiales, consideramos que es correcta, sin embargo no asumimos ninguna responsabilidad por errores, cambios, omisiones o daños que resulten de estos.

Cables de Embrague / Clutch Cable

NUMERO DE PARTE PART NUMBER	NUMERO DE CLIENTE CUSTOMER NUMBER	AÑO / YEAR	VEHICULO / VEHICLE	LONG. A
RE-306			EMBRAGUE R-4L	1060

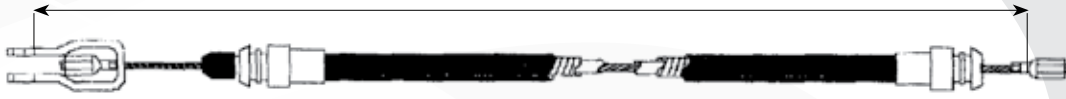

RE-307			EMBRAGUE ALLIANCE	1040	a
RE-312	7700763232A	87	EMBRAGUE R-9, R-11 TT, SUPER 5 EXPRESS 89	1044	

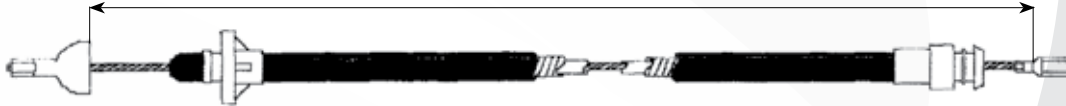

RE-310	7700761086		EMBRAGUE R-5, SUPER CINQUE EXPRESS R-9, R-11	1047	
RE-313	7700787470	1988	EMBRAGUE R-19 TT	1014	
	7700811013		EMBRAGUE ECLAIRE		



RE-311	7700620231		EMBRAGUE R-4 PLUS	651	
--------	------------	--	-------------------	-----	--



RE-314		2000-2007	CABLE DE EMBRAGUE CLIO STD 1.6 L	960	
--------	--	-----------	----------------------------------	-----	--

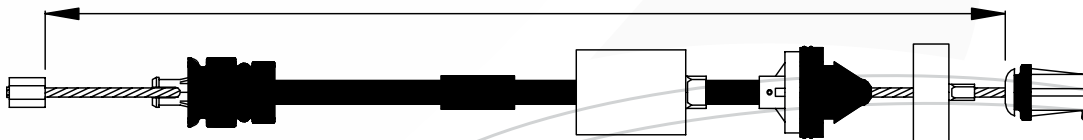

NUMERO DE PARTE PART NUMBER	NUMERO DE CLIENTE CUSTOMER NUMBER	AÑO / YEAR	VEHICULO / VEHICLE	LONG. A
--------------------------------	--------------------------------------	------------	--------------------	---------

SU-300	7370, 26011/12	79-84	EMBRAGUE 2D, 3D, 4D SW 4CIL 1189cc-1781cc; 1600, STD, DL 4 CIL 1595cc; HATCH 4CIL 1595cc-1781cc, TODOS LOS MODELOS W/2 DR, 4DR, HARD TOP & STATION WAGON L4 1600cc	640
--------	----------------	-------	--	-----



\*Importante: La información indicada en esta publicación, ha sido obtenida por fuentes confiables y oficiales, consideramos que es correcta, sin embargo no asumimos ninguna responsabilidad por errores, cambios, omisiones o daños que resultaran de estos.\*

**SUBARU**

# Cables de Embrague / Clutch Cable



NUMERO DE PARTE PART NUMBER	NUMERO DE CLIENTE CUSTOMER NUMBER	AÑO / YEAR	VEHICULO / VEHICLE	LONG. A
SU-301	6371, 20163/20164	72-80	EMBRAGUE 2D, 3D, 4D, SW 4CIL 1189cc-1781cc; BRAT 4CIL 1595cc; DL/GL 1.4 & 1.6	605



SU-302	73702.6033	84-89	EMBRAGUE 1800, GL, DL, GL-4WD 4CIL 1781cc	916
--------	------------	-------	---	-----



SU-303	7370.26032	81-83	EMBRAGUE 1800, GL, DL, GL-4WD 4CIL 1781cc	913
--------	------------	-------	---	-----



SU-304	37026.GA100	85-89	EMBRAGUE 1800 GL, DL, GL-2WD 4CIL 1781cc; DL 1,3 & 1,6	910
--------	-------------	-------	--	-----

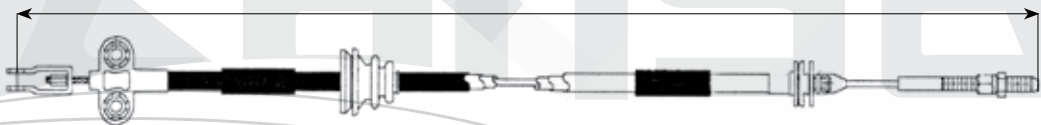

NUMERO DE PARTE PART NUMBER	NUMERO DE CLIENTE CUSTOMER NUMBER	AÑO / YEAR	VEHICULO / VEHICLE	LONG. A
SZ-300	23710,83023/21	86-89	EMBRAGUE SANTANA SJ413 (CANADA), SAMURAI 1298cc-1324cc 4 CIL	1910



SZ-301	23710.82064A	87-90	EMBRAGUE SPRINT, SWIFT 1.3	624
--------	--------------	-------	----------------------------	-----



Importante: La información indicada en esta publicación, ha sido obtenida por fuentes confiables y oficiales, consideramos que es correcta, sin embargo no asumimos ninguna responsabilidad por errores, cambios, omisiones o daños que resulten de estos.

Cables de Embrague / Clutch Cable

NUMERO DE PARTE PART NUMBER	NUMERO DE CLIENTE CUSTOMER NUMBER	AÑO / YEAR	VEHICULO / VEHICLE	LONG. A
SZ-302	23710.63B10	89-93	EMBRAGUE SWIFT (TAXI) 1.3 (1298cc-1324cc) 4CIL	580
SZ-303	23710.60B10	93	EMBRAGUE SWIFT 1.0, SPRINT	650
SZ-304	23710.60B10A		EMBRAGUE SWIFT CHEVETAXI 1.3	658
SZ-308	2371060G21/20	96-98	EMBRAGUE BALENO	628



SZ-305	23710.85232		EMBRAGUE SUZUKI FURGON 1000	2086
--------	-------------	--	-----------------------------	------

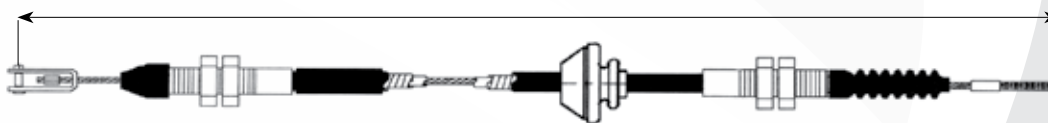

SZ-306	23710 60A11	-98	EMBRAGUE SUZUKI SIDEKICK 8 VALVULAS	1880
--------	-------------	-----	-------------------------------------	------



SZ-307	2371057B12 237105B12 237105B10 23710 7B11 237107B12	92-98	EMBRAGUE SUZUKI SIDEKICK 2X90 16 VALVULAS X90 JAPÓN & CANADÁ, L4 1600cc	1876
--------	---	-------	--	------



SZ-309	23710-84161	96-98	EMBRAGUE MARUTTI	530
--------	-------------	-------	------------------	-----



SZ-310	2371085231		EMBRAGUE SUZUKI CARRY	2086
--------	------------	--	-----------------------	------

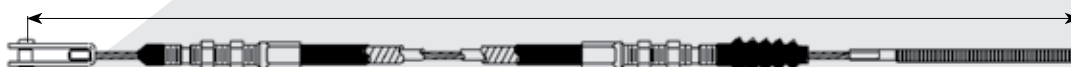

"Importante: La información indicada en esta publicación, ha sido obtenida por fuentes confiables y oficiales, consideramos que es correcta, sin embargo no asumimos ninguna responsabilidad por errores, cambios, omisiones o daños que resultaran de estos".

NUMERO DE PARTE PART NUMBER	NUMERO DE CLIENTE CUSTOMER NUMBER	AÑO / YEAR	VEHICULO / VEHICLE	LONG. A
TY-300	3134016110	83-88	EMBRAGUE PICK UP LARGA TERCEL ENG. 1452cc L4	978

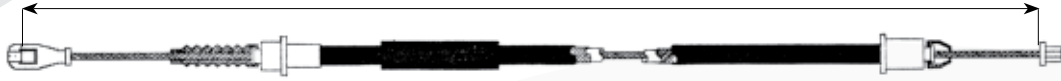

TY-301	8942511851		EMBRAGUE TOYOTA	1558
--------	------------	--	-----------------	------



TY-302	8941343970		EMBRAGUE TOYOTA	1130
--------	------------	--	-----------------	------



TY-304	3134016070	80-82	EMBRAGUE TERCEL AJ 11, TODOS LOS MODELOS ENG. 1452cc L4	1005
--------	------------	-------	---	------

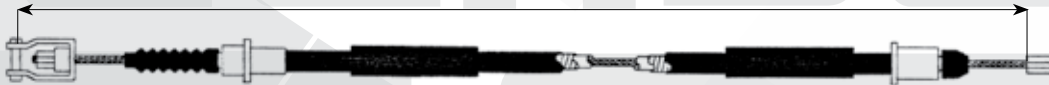

TY-305	3134019155	75-79	EMBRAGUE COROLLA KE 30, TODOS LOS MODELOS CON TRANS MANUAL ENG 1166cc-1200cc L4	1778
--------	------------	-------	--	------

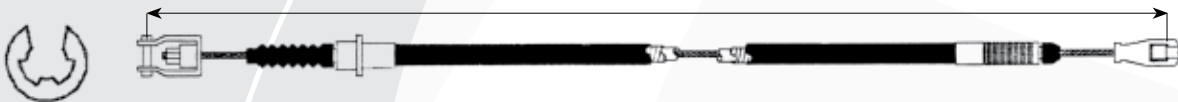

TY-306	3134087625	90	EMBRAGUE CHARADE ROCKY	2235
--------	------------	----	------------------------	------

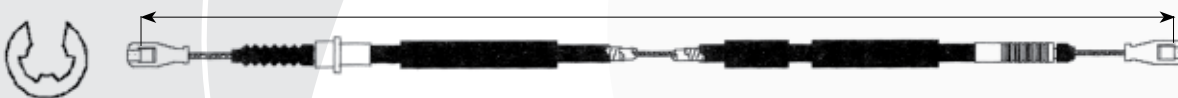

Importante: La información indicada en esta publicación, ha sido obtenida por fuentes confiables y oficiales, consideramos que es correcta, sin embargo no asumimos ninguna responsabilidad por errores, cambios, omisiones o daños que resulten de estos.

NUMERO DE PARTE PART NUMBER	NUMERO DE CLIENTE CUSTOMER NUMBER	AÑO / YEAR	VEHICULO / VEHICLE	LONG. A
TY-307	3134019086		EMBRAGUE TOYOTA 1000	1550
TY-308	3134019085	69-70	EMBRAGUE TOYOTA KP-30 2K	1559



TY-309	3134019225	80-	EMBRAGUE TOYOTA COROLLA KE-70	1705
--------	------------	-----	-------------------------------	------

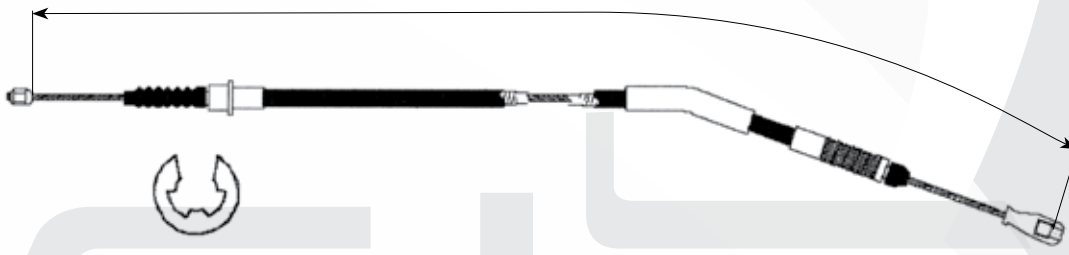

TY-310	3134029085		EMBRAGUE TOYOTA COROLLA 4K L-ACE	2490
--------	------------	--	----------------------------------	------

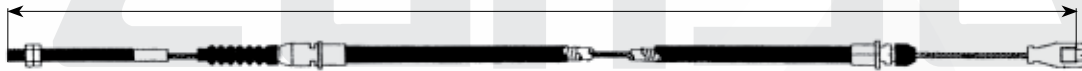

TY-311	3134027121		EMBRAGUE TOYOTA KM36/37 L-ACE	2377
--------	------------	--	-------------------------------	------



TY-312	3134019196	78-	EMBRAGUE TOYOTA STARLET	1581
--------	------------	-----	-------------------------	------

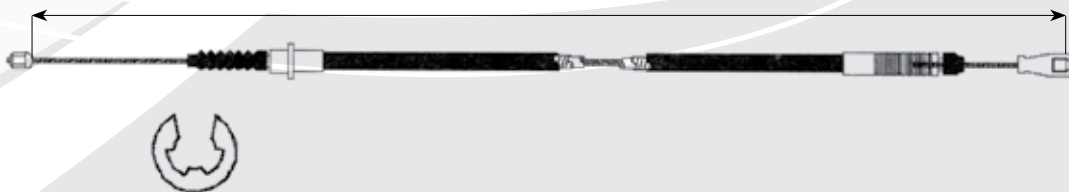

"Importante: La información indicada en esta publicación, ha sido obtenida por fuentes confiables y oficiales, consideramos que es correcta, sin embargo no asumimos ninguna responsabilidad por errores, cambios, omisiones o daños que resultaran de estos".



# Cables de Embrague / Clutch Cable



NUMERO DE PARTE PART NUMBER	NUMERO DE CLIENTE CUSTOMER NUMBER	AÑO / YEAR	VEHICULO / VEHICLE	LONG. A
VL-300	MP710730		EMBRAGUE AUTOBUS VOLVO C11 MOTOR CUMMINS ISB TRANS. SPICER	2210

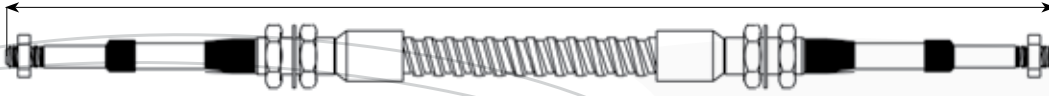

NUMERO DE PARTE PART NUMBER	NUMERO DE CLIENTE CUSTOMER NUMBER	AÑO / YEAR	VEHICULO / VEHICLE	LONG. A
VW-300	113721335Z		EMBRAGUE SEDAN 1200 1500	2182
VW-301	111721335C		EMBRAGUE SEDAN 1600 & SAFARI	2210
VW-302	311721335A		EMBRAGUE BRASILIA	2260
VW-304	BAC721335		EMBRAGUE HORMIGA	1547
VW-350	113721355Z		EMBRAGUE REFORZADO SEDAN 1200/1500	2182
VW-351	111721335C		EMBRAGUE REFORZADO SEDAN 1600 & SAFARI	2210
VW-352	311721335A		EMBRAGUE REFORZADO BRASILIA	2260

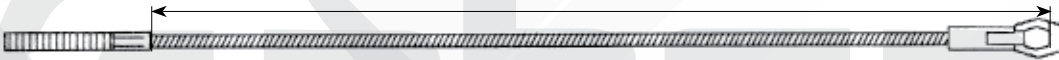

VW-300 AC	113721335AC	65-	EMBRAGUE BEETLE SEDAN GHIA & TIPO I	2262
VW-301 A	111721335A	60-61	EMBRAGUE SEDAN 1200 Y GHIA	2247
VW-301 E	111721335E	74-79	EMBRAGUE SEDAN TIPO I	2282
VW-302 A	311721335A	66-73	EMBRAGUE TIPO II	2327
VW-322	111 721 335E	94-04	EMBRAGUE SENCILLO VW SEDAN 1600 i	2267
VW-357	111 721 335E	94-04	EMBRAGUE REFORZADO VW SEDAN 1600 i	2267



VW-301 C	111721335C	72-74	EMBRAGUE TIPO II	2284
----------	------------	-------	------------------	------



VW-303	311721335J	-87	EMBRAGUE COMBI	3131
VW-353	311721335J	-87	EMBRAGUE REFORZADO COMBI	3131
VW-354		89-90	EMBRAGUE REFORZADO COMBI	3100
VW-355		87-89	EMBRAGUE REFORZADO COMBI	3140
VW-321	2377213351		EMBRAGUE COMBI (CORTO) 3mt.	3082



Importante: La información indicada en esta publicación, ha sido obtenida por fuentes confiables y oficiales, consideramos que es correcta, sin embargo no asumimos ninguna responsabilidad por errores, cambios, omisiones o daños que resulten de estos.

Cables de Embrague / Clutch Cable

NUMERO DE PARTE PART NUMBER	NUMERO DE CLIENTE CUSTOMER NUMBER	AÑO / YEAR	VEHICULO / VEHICLE	LONG. A
VW-303 B	211721335B	3/55-59 62-67	EMBRAGUE TIPO II TRANSPORTER 1.21L & BUS	3116
VW-303 C	211721335C	60-61	EMBRAGUE TRANSPORTER 1.21L TYPE II	3115
VW-303 J	211721335J	71-79	EMBRAGUE TRANSPORTER 1.21L TYPE II	3215



VW-303 E	211721335E	67-71	EMBRAGUE TRANSPORTER 1.21L & TYPE II	3168
VW-317	211751335I	76	EMBRAGUE COMBI (EXPORTACION)	3100
VW-356	211721335J	72-79	EMBRAGUE COMBI PANEL 1600 TYPE II	3210

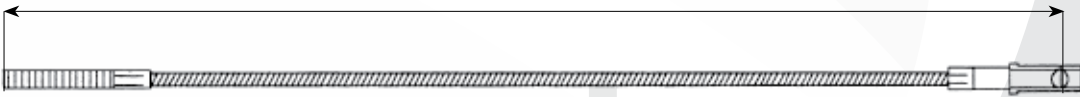

VW-305	171721335E	81-87	EMBRAGUE CARIBE/ATLANTIC, JETTA, STD. 4CIL	800
VW-305 C	531721335C	76-92	EMBRAGUE SCIROCCO (EXC. 16V)	880
VW-305 E	171721335E/D	79-89	EMBRAGUE JETTA, RABBIT, PICK UP, RABBIT CONVERTIBLE, CABRIOLET TRANS MANUAL 4CIL 1780cc	800

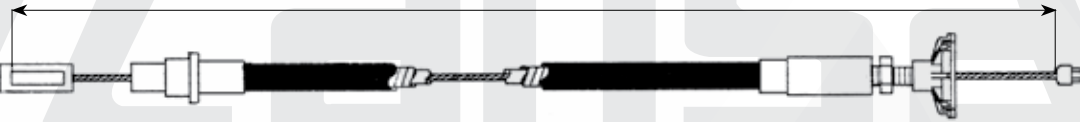

VW-306	191721335M	87-92	EMBRAGUE GOLF STD. (EXP: RABBIT GTI JETTA-GAS)	810
VW-310	191721335M	87-92	EMBRAGUE JETTA STD.	810



VW-307	321721335H	84-87	EMBRAGUE CORSAR STD.	950
--------	------------	-------	----------------------	-----

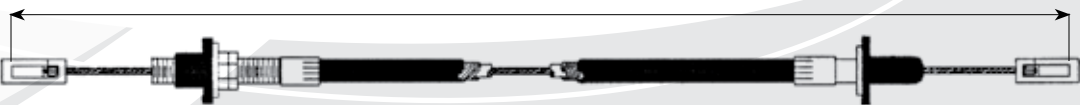

"Importante: La información indicada en esta publicación, ha sido obtenida por fuentes confiables y oficiales, consideramos que es correcta, sin embargo no asumimos ninguna responsabilidad por errores, cambios, omisiones o daños que resultaran de estos".



# Cables de Embrague / Clutch Cable



NUMERO DE PARTE PART NUMBER	NUMERO DE CLIENTE CUSTOMER NUMBER	AÑO / YEAR	VEHICULO / VEHICLE	LONG. A
VW-308	171721335E	81-87	EMBRAGUE CARIBE/ATLANTIC STD. (TERM. DE METAL)	795



VW-312	3077213352	87-90	EMBRAGUE VOLSWAGEN FOX	985
--------	------------	-------	------------------------	-----

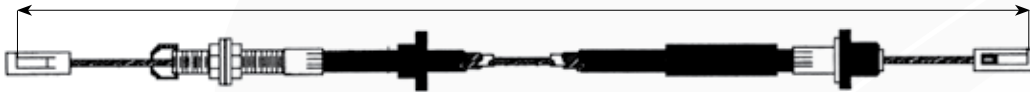

VW-313	1H1721335A	93-2000	EMBRAGUE GOLF GTI, JETTA, JETTA III, CABRIO, DERBY MOD. A3 & S4 2000cc L4	820
--------	------------	---------	---	-----



VW-314	191721344AB	93-2000	EMBRAGUE GOLF JETTA DERBY MOD. A3 & S4 (EXPORTACION)	799
--------	-------------	---------	--	-----

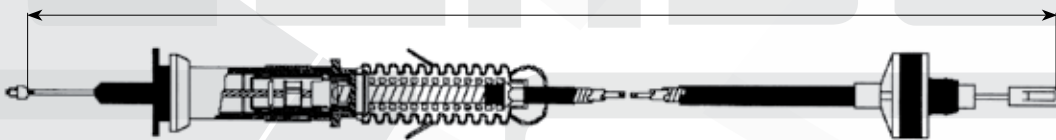

VW-315	377721335	98-2001	EMBRAGUE POINTER	977
--------	-----------	---------	------------------	-----



VW-316	7D1721335	2000-2004	EMBRAGUE EUROVAN 1.8L	1250
--------	-----------	-----------	-----------------------	------

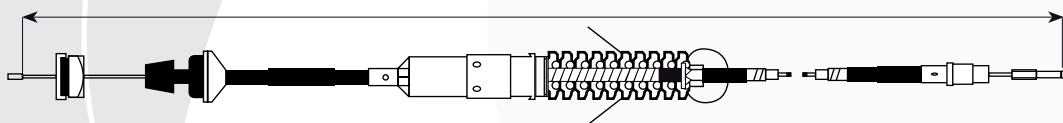

Importante: La información indicada en esta publicación, ha sido obtenida por fuentes confiables y oficiales, consideramos que es correcta, sin embargo no asumimos ninguna responsabilidad por errores, cambios, omisiones o daños que resulten de estos.

Cables de Embrague / Clutch Cable

NUMERO DE PARTE PART NUMBER	NUMERO DE CLIENTE CUSTOMER NUMBER	AÑO / YEAR	VEHICULO / VEHICLE	LONG. A
VW-318	307 721 335 6		EMBRAGUE GOL/SAVEIRO/VOYAGE/PARATI AP 1.6/1.8	905



VW-319	303 721 331 1		EMBRAGUE GOL/SAVEIRO/VOYAGE/PARATI AP 1.6/1.8 (ENF AGUA)	1055
--------	---------------	--	--	------



VW-320	6K1-721-335 C	95-00	EMBRAGUE DERBY	855
--------	---------------	-------	----------------	-----

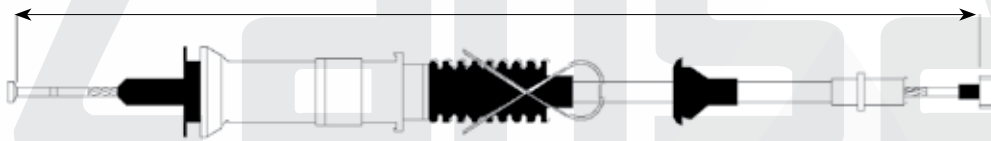

VW-323	377721335	97-99	CABLE DE EMBRAGUE POINTER 1.8 L	1005
--------	-----------	-------	---------------------------------	------



VW-324	701721335	00-05	C. EMB. EUROVAN IMPORT SOLO P/GASOLINA AJASTE MANUAL	1300
--------	-----------	-------	--	------

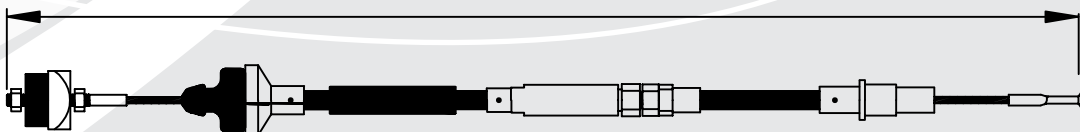

\*Importante: La información indicada en esta publicación, ha sido obtenida por fuentes confiables y oficiales, consideramos que es correcta, sin embargo no asumimos ninguna responsabilidad por errores, cambios, omisiones o daños que resultaran de estos\*.



# Cables de Embrague / Clutch Cable



NUMERO DE PARTE PART NUMBER	NUMERO DE CLIENTE CUSTOMER NUMBER	AÑO / YEAR	VEHICULO / VEHICLE	LONG. A
VW-325	1H1721335-A	1993-	C. EMB. GOLF, JETTA, DERBY MOD A3 Y S4 AJUSTE MANUAL	820

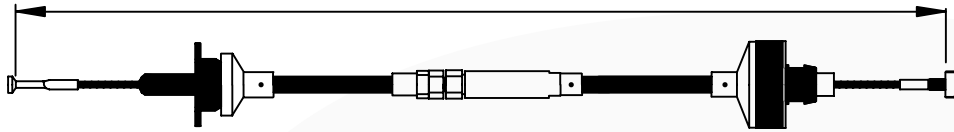

VW-326	191721335AB	1993-	C. EMB. GOLF, JETTA, DERBY MOD A3 Y S4 (EXP) AJUSTE MANUAL	799
--------	-------------	-------	--	-----

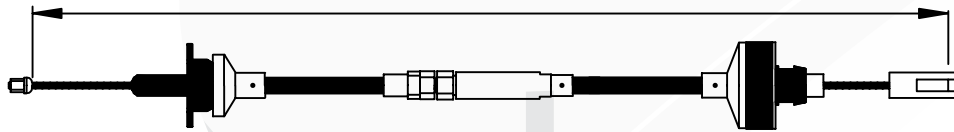

VW-327	6K1721335-C	95-00	CABLE DE EMBRAGUE DERBY AJUSTE MANUAL	855
--------	-------------	-------	---------------------------------------	-----

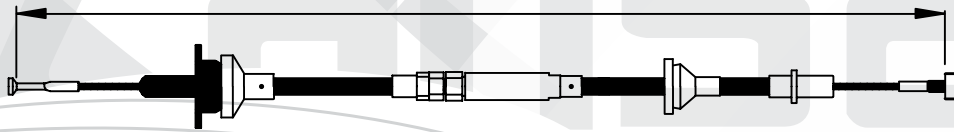

## YUGO



NUMERO DE PARTE PART NUMBER	NUMERO DE CLIENTE CUSTOMER NUMBER	AÑO / YEAR	VEHICULO / VEHICLE	LONG. A
YU-300	46625514 46623277	87-	YUGO 45	507



Importante: La información indicada en esta publicación, ha sido obtenida por fuentes confiables y oficiales, consideramos que es correcta, sin embargo no asumimos ninguna responsabilidad por errores, cambios, omisiones o daños que resulten de estos.

Cables de Embrague / Clutch Cable

NUMERO DE PARTE PART NUMBER	NUMERO DE CLIENTE CUSTOMER NUMBER	AÑO / YEAR	VEHICULO / VEHICLE	LONG. A
CH-400		77-82	VEL. CHRYSLER ADAPTADOR TROMPO	1900



CH-401		77-82	VEL. CHRYSLER ADAPTADOR PERNO	1915
--------	--	-------	-------------------------------	------



CH-402		68-74	VEL. DART VALIANT ADAPTADOR TROMPO	1630
--------	--	-------	------------------------------------	------



CH-403		75-76	VEL. DART VALIANT SNAP ON TUERCA	1590
--------	--	-------	----------------------------------	------



CH-404			VEL. CHRYSLER K SUPERIOR	1120
--------	--	--	--------------------------	------



CH-405			VEL. CHRYSLER K SUPERIOR INFERIOR	1685
--------	--	--	-----------------------------------	------

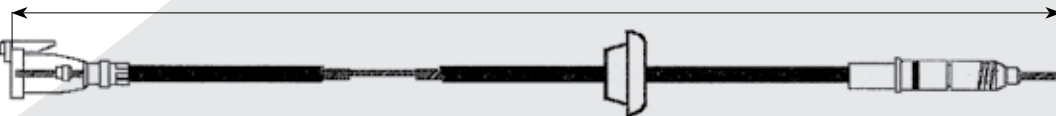

"Importante: La información indicada en esta publicación, ha sido obtenida por fuentes confiables y oficiales, consideramos que es correcta, sin embargo no asumimos ninguna responsabilidad por errores, cambios, omisiones o daños que resultaran de estos".

NUMERO DE PARTE PART NUMBER	NUMERO DE CLIENTE CUSTOMER NUMBER	AÑO / YEAR	VEHICULO / VEHICLE	LONG. A
CH-406		78-84	VEL. CHRYSLER CORDOBA LEBARON 8 CIL.	1680



CH-407			VEL. DART K INF. (COMPLEMENTO CH-404)	650
--------	--	--	---------------------------------------	-----

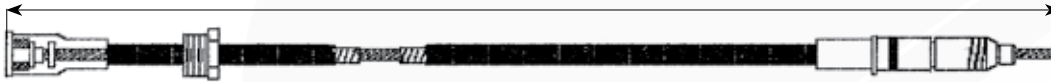

CH-408		91	VEL. CAMION DODGE 350	1555
--------	--	----	-----------------------	------



CH-409		82-	VEL. MODELOS K TRANS. AUT	1355
--------	--	-----	---------------------------	------



CH-410	3591189	77-79	VEL. CHRYSLER ASPEN MODELO	1580
--------	---------	-------	----------------------------	------



CH-411		84-88	VEL. MAGNUM K MOTOR 2.5L TURBO FASE1 S/INTERCOOLER & FASE2 C/INTERCOOLER TRANS MANUAL 5 VEL.	565
		85	VEL. INFERIOR MAGNUM TURBO 5 VEL.	

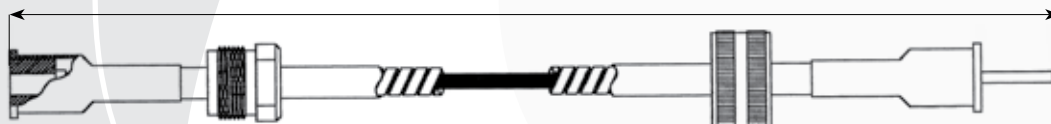

\*Importante: La información indicada en esta publicación, ha sido obtenida por fuentes confiables y oficiales, consideramos que es correcta, sin embargo no asumimos ninguna responsabilidad por errores, cambios, omisiones o daños que resulten de estos.

Cables de Velocímetro / Speedometer Cables

NUMERO DE PARTE PART NUMBER	NUMERO DE CLIENTE CUSTOMER NUMBER	AÑO / YEAR	VEHICULO / VEHICLE	LONG. A
CU-450			TACOMETRO AUTOBUS MASA SOMEX CUMMINS	1030

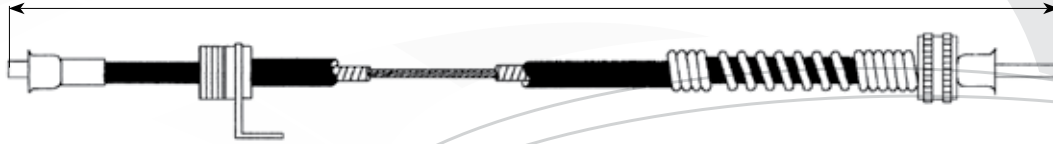

NUMERO DE PARTE PART NUMBER	NUMERO DE CLIENTE CUSTOMER NUMBER	AÑO / YEAR	VEHICULO / VEHICLE	LONG. A
DW-400	96186180		VEL. DAEWOO	930

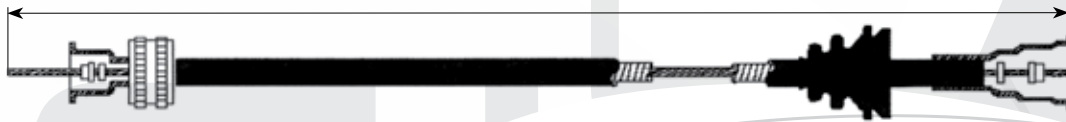

NUMERO DE PARTE PART NUMBER	NUMERO DE CLIENTE CUSTOMER NUMBER	AÑO / YEAR	VEHICULO / VEHICLE	LONG. A
DI-450			TACOMETRO DINA 531/631 G1, D532 G2 J1 ENTRADA V.D.O. M18	1065



DI-451	A1118312		TACOMETRO DINA D531/631 G1, DS32G2 JATGEO ENTRADA S.W.	1155
DI-453	A28183A12		TACOMETRO DINA D861K1 TRACTOCAMION	1440
DI-454	A10183-12		VELOCIMETRO DINA 533G3	3030
DI-455			VELOCIMETRO DINA TRACTOCAMION 861K1	2845
DI-456	A2183-12		VELOCIMETRO DINA CAMION ESPIGA GRUESA	1750
DI-460			TACOMETRO DINA	1150
DI-463			VELOCIMETRO CAMION SW 5/8"	1680



"Importante: La información indicada en esta publicación, ha sido obtenida por fuentes confiables y oficiales, consideramos que es correcta, sin embargo no asumimos ninguna responsabilidad por errores, cambios, omisiones o daños que resultaran de estos".

NUMERO DE PARTE PART NUMBER	NUMERO DE CLIENTE CUSTOMER NUMBER	AÑO / YEAR	VEHICULO / VEHICLE	LONG. A
DI-452	A-2234140		TACOMETRO DINA 604 & AUTOBUS DELFIN	865



DI-457			VEL. DINA CAMION ESPIGA DELGADA	1685
--------	--	--	---------------------------------	------

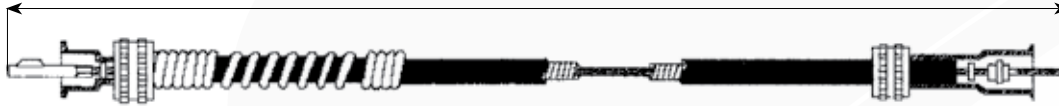

DI-461			TACOMETRO TRACTOCAMION 861 PERNO MEDIANO	2845
--------	--	--	--	------



DI-462			VEL. DINA MOTOR CUMMINS ENTRADA V.D.O.	1560
--------	--	--	--	------

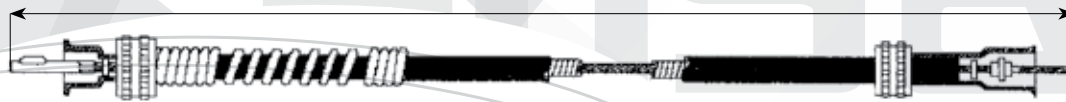

**FAMSA**

NUMERO DE PARTE PART NUMBER	NUMERO DE CLIENTE CUSTOMER NUMBER	AÑO / YEAR	VEHICULO / VEHICLE	LONG. A
FA-402			VELOCIMETRO FAMSA TRACTOCAMION MOTOR INTERNATIONAL	2551
FA-451			TACOMETRO FAMSA MOTOR PERKINS	1531

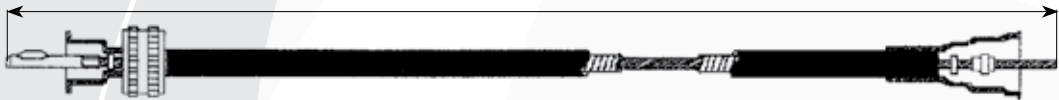

FA-450			TACOMETRO CAMION FAMSA TRACTOCAMION MOTOR INTERNATIONAL	1411
--------	--	--	---	------

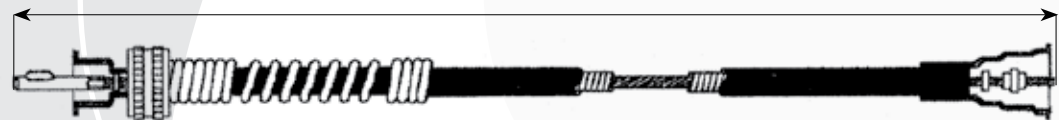

"Importante: La información indicada en esta publicación, ha sido obtenida por fuentes confiables y oficiales, consideramos que es correcta, sin embargo no asumimos ninguna responsabilidad por errores, cambios, omisiones o daños que resulten de estos."

Cables de Velocímetro / Speedometer Cables

NUMERO DE PARTE PART NUMBER	NUMERO DE CLIENTE CUSTOMER NUMBER	AÑO / YEAR	VEHICULO / VEHICLE	LONG. A
--------------------------------	--------------------------------------	------------	--------------------	---------

FO-400

VEL. CAMION FORD F100/F350/F600

1750

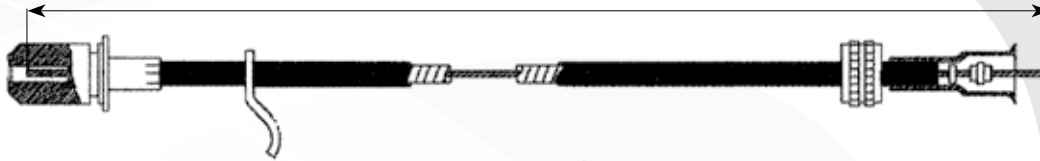

FO-401

VEL. LTD, GRAND MARQUIS, FAIRMONT CROWN VICTORIA

1880

FO-402

-1991

VEL. MICROBUS FORD

3200

FO-404

83TK17260AA

1972-91

VEL. CAMION F-350

1890

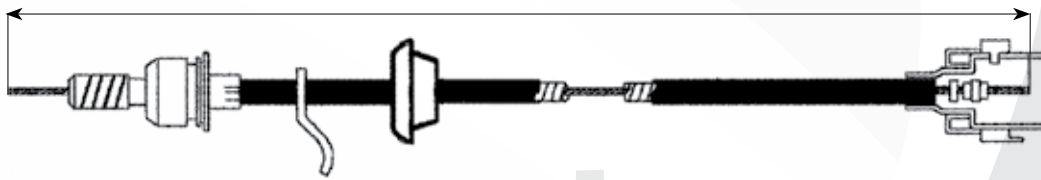

FO-403

1988-91

VEL. TOPAZ, GHIA

D9BZ-9A820A

1980-85

VEL. BRONCO, BRONCO II 4 SPD W/CRUISE (SUPERIOR) AT Y MT

918

D9ZZ-9A820A

1980-85

VEL. F100/150 W/ CRUISE (SUPERIOR) AT. Y MT F250, 350

E0SZ-9A820A

1969-71

VEL. LINCOLN CONTINENTAL, TOWN CAR

E0TZ-9A820F

1978-99

VEL. LINCOLN CONTINENTAL, TOWN CAR W/CRUISE (SUPERIOR)

E1FZ-9A820C

1979-82

VEL. MERCURY CAPRI 4 VEL. W/CRUISE (SUPERIOR)

E1FZ9A820E

1971-73

VEL. MERCURY COLONI PARK, GRAND MARQUIS, MONT CLAIR MONTEREY

E2FZ-9A820A

1979-82

VEL. MERCURY COMET, CYCLONE, MONTERO, ZEPHYR MT

E2SZ-9A820D

1980-82

VEL. COUGAR XR7, W/C4 TRANS, W/CRUISE, XR7 W/200 ENG, 230 ENG, AT, MT

1981-83

VEL. LN-7, LYNX 4 M 8 CILV

FO-405

1988-91

VEL. TOPAZ CON TACOMETRO S.W. (TUERCA GRANDE)

918

FO-407

F23Z17255B

1990-92

VEL. TOPAZ GHIA

920



FO-406

96FB17260CC

1998-

VEL. FIESTA

830

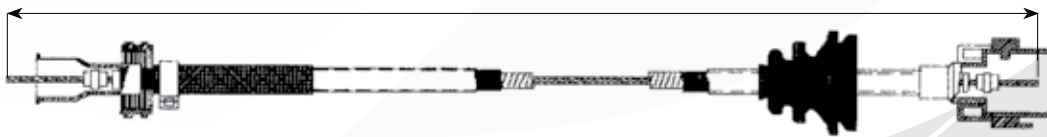

FO-408

87HU17260AA

C. DE VELOCIMETRO FORD FO 1622/4030/283

3540

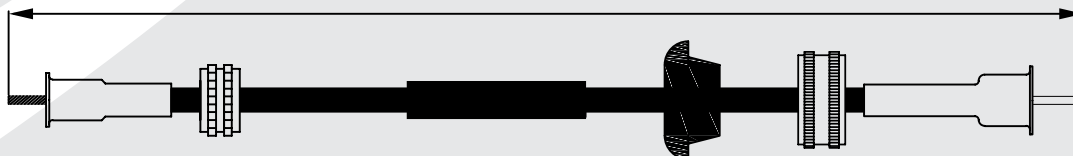

\*Importante: La información indicada en esta publicación, ha sido obtenida por fuentes confiables y oficiales, consideramos que es correcta, sin embargo no asumimos ninguna responsabilidad por errores, omisiones o daños que resultaran de estos.\*



# Cables de Velocímetro / Speedometer Cables



NUMERO DE PARTE PART NUMBER	NUMERO DE CLIENTE CUSTOMER NUMBER	AÑO / YEAR	VEHICULO / VEHICLE	LONG. A
FO-409	TNJ957805		C. DE VELOCIMETRO FORD FO 2425/3530/2422	3980

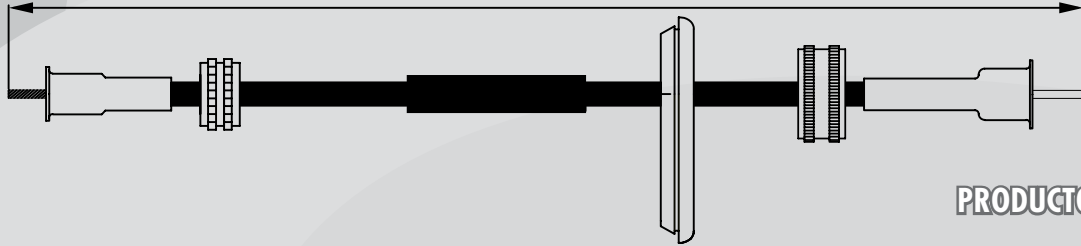

PRODUCTO NUEVO

FO-410	2UH957805		C. DE VELOCIMETRO FO 814/915	3122
--------	-----------	--	------------------------------	------

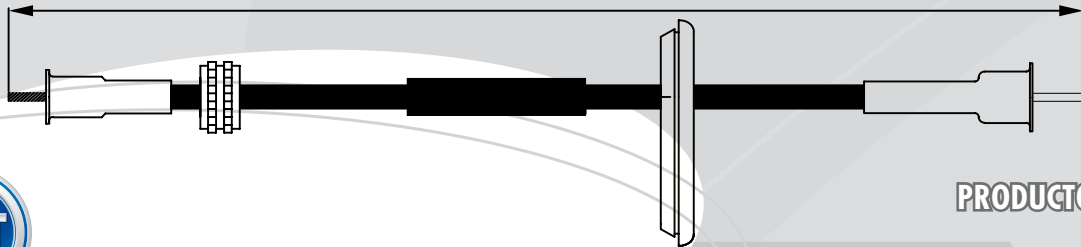

PRODUCTO NUEVO



NUMERO DE PARTE PART NUMBER	NUMERO DE CLIENTE CUSTOMER NUMBER	AÑO / YEAR	VEHICULO / VEHICLE	LONG. A
FT-400	7515883	91-92	VEL. UNO/PREMIO/ELBA/FIORINO	1102
FT-402	5960711			



FT-401	4399459		VEL. 127 DIESEL	875
--------	---------	--	-----------------	-----



FT-403	5980997/4338		VEL. 131 TT 5m-131 AUTOMATICO	1775
--------	--------------	--	-------------------------------	------



FT-404	4383351/5981		VEL. RITMO TODOS EXC. TD REGATA	1280
--------	--------------	--	---------------------------------	------



Importante: La información indicada en esta publicación, ha sido obtenida por fuentes confiables y oficiales, consideramos que es correcta, sin embargo no asumimos ninguna responsabilidad por errores, cambios, omisiones o daños que resulten de estos.

Cables de Velocímetro / Speedometer Cables

NUMERO DE PARTE PART NUMBER	NUMERO DE CLIENTE CUSTOMER NUMBER	AÑO / YEAR	VEHICULO / VEHICLE	LONG. A
GM-400	2778343	75-78	VEL. CHEVY NOVA 4 VEL.	1426

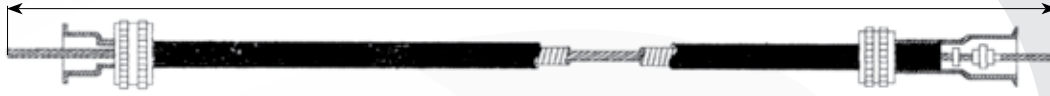

GM-401	93405919	79-83	VEL. CHEVELLE MALIBU STD. 3 & 4 VEL.	2211
GM-402	93403849	77-82	VEL. CAPRICE, CUTLASS, CAVALIER, MALIBU AUT (80)	1801
GM-403		82-84	VEL. CITATION CELEBRITY STD.	1071

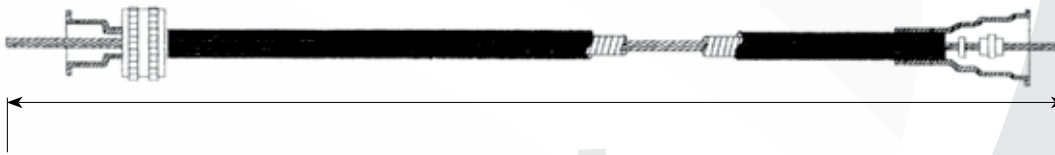

GM-404	94423497	96-2000	VELOCIMETRO CHEVY CORSA	854
GM-405	94654204	86-91	VEL. CHEVROLET CHEVETTE AUT. 73	1861



## HONDA

NUMERO DE PARTE PART NUMBER	NUMERO DE CLIENTE CUSTOMER NUMBER	AÑO / YEAR	VEHICULO / VEHICLE	LONG. A
HN-400	78410SH9A01	1986-89	VELOCIMETRO ACCORD	1548
		1981-82	VELOCIMETRO CIVIC	
		1979-82	VELOCIMETRO PRELUDE	

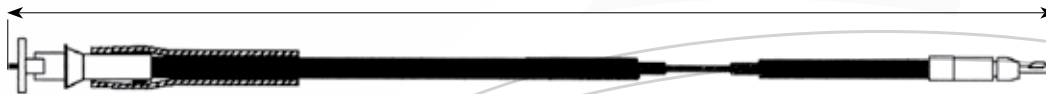

## HYUNDAI

NUMERO DE PARTE PART NUMBER	NUMERO DE CLIENTE CUSTOMER NUMBER	AÑO / YEAR	VEHICULO / VEHICLE	LONG. A
HY-400	943 1043602		VEL. HYUNDAI	3410



\*Importante: La información indicada en esta publicación, ha sido obtenida por fuentes confiables y oficiales, consideramos que es correcta, sin embargo no asumimos ninguna responsabilidad por errores, cambios, omisiones o daños que resultaran de estos\*.

Cables de Velocímetro / Speedometer Cables

NUMERO DE PARTE PART NUMBER	NUMERO DE CLIENTE CUSTOMER NUMBER	AÑO / YEAR	VEHICULO / VEHICLE	LONG. A
HY-401	5071848 AA	2000-	C. VELOCIMETRO ATOS MOTOR 1.1L	880

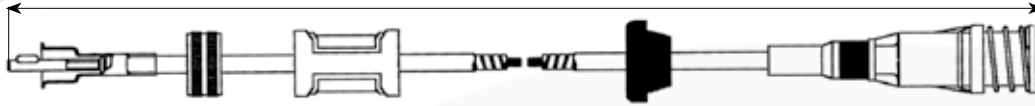

HY-402		1994-	VELOCIMETRO EXCEL & ELANTRA	913
--------	--	-------	-----------------------------	-----

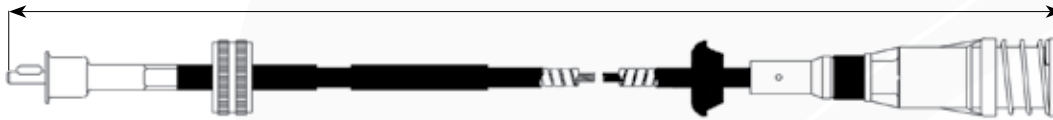

HY-403		1994-	VELOCIMETRO PORTER	3500
--------	--	-------	--------------------	------



## ISUZU

NUMERO DE PARTE PART NUMBER	NUMERO DE CLIENTE CUSTOMER NUMBER	AÑO / YEAR	VEHICULO / VEHICLE	LONG. A
IS-400	894434 484	89-	VEL. PICKUP LUV	2387
IS-401	894222 983 0	76-88	VEL. PICKUP LUV	2321

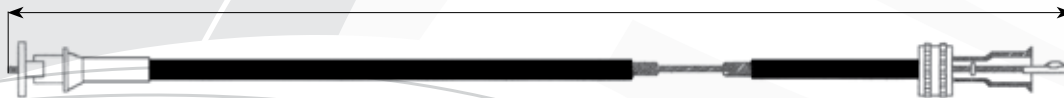

## KIA MOTORS

NUMERO DE PARTE PART NUMBER	NUMERO DE CLIENTE CUSTOMER NUMBER	AÑO / YEAR	VEHICULO / VEHICLE	LONG. A
KI-400	KK198 60070C		C. DE VELOCIMETRO KIA POP 1.1 MOBIS	800

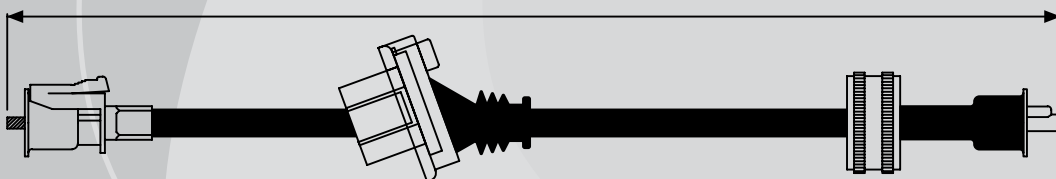

**PRODUCTO NUEVO**

"Importante: La información indicada en esta publicación, ha sido obtenida por fuentes confiables y oficiales, consideramos que es correcta, sin embargo no asumimos ninguna responsabilidad por errores, omisiones o daños que resulten de estos".

NUMERO DE PARTE PART NUMBER	NUMERO DE CLIENTE CUSTOMER NUMBER	AÑO / YEAR	VEHICULO / VEHICLE	LONG. A
MA-450			TACOMETRO AUTOBUS MOTOR G.M.C. MASA	880

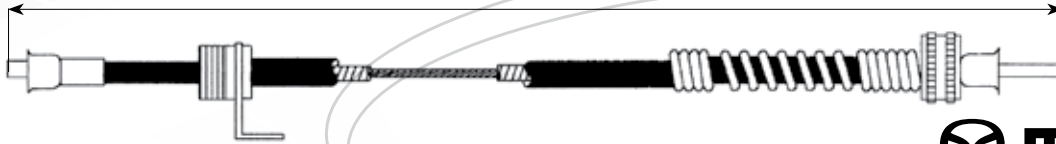

NUMERO DE PARTE PART NUMBER	NUMERO DE CLIENTE CUSTOMER NUMBER	AÑO / YEAR	VEHICULO / VEHICLE	LONG. A
MZ-400	8F6760070	86-87	VEL. MAZDA 323 NX	1020

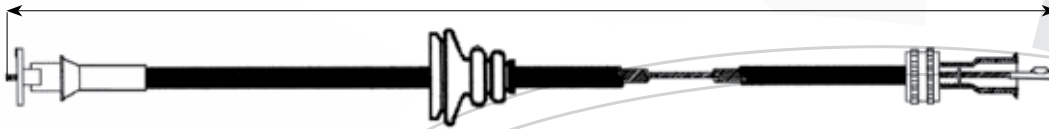

NUMERO DE PARTE PART NUMBER	NUMERO DE CLIENTE CUSTOMER NUMBER	AÑO / YEAR	VEHICULO / VEHICLE	LONG. A
NI-400	2505013000 2505020600 2505077700 2505041602 B505022000	1965-78	VEL. DATSUN SEDAN 1600, 510 4 VEL 11200 (B210) 610, 310	1550

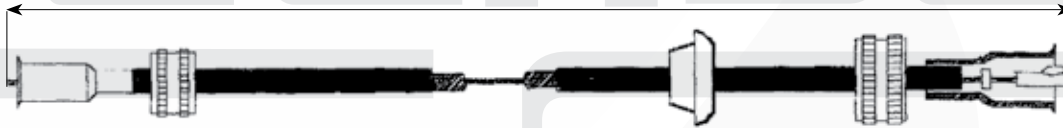

NI-401	B505003W00	79-84	VEL. DATSUN	1415
NI-403	2505033W00	80-88	VEL. PICK UP 720 & 2WD (A 6/81)	1850
NI-417	25050W5610	79-84	C. VEL. DATSUN SEDAN A10 STANDARD	2048

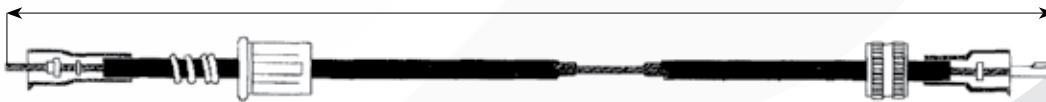

NI-402	24820F4285	92-93	VEL. TSURU III GST	830
NI-404	2505065Y00	-93	VEL. TSUBAME	830
NI-407		1990-	VEL. ICHI-VAN STD.	3226
NI-409	25050F4200	94-2000	VEL. TSURU III SENTRA SUNNY V16, B14	830
NI-416	2505002A05	84-87	C. VELOCIMETRO TSURU I	873

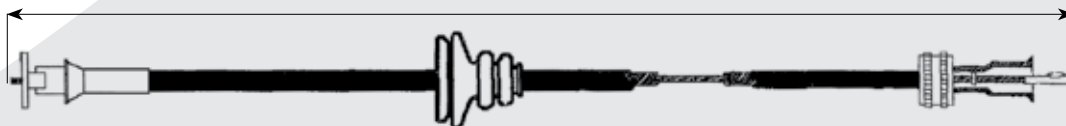

\*Importante: La información indicada en esta publicación, ha sido obtenida por fuentes confiables y oficiales, consideramos que es correcta, sin embargo no asumimos ninguna responsabilidad por errores, cambios, omisiones o daños que resultaran de estos\*.

Cables de Velocímetro / Speedometer Cables



# Cables de Velocímetro / Speedometer Cables



NUMERO DE PARTE PART NUMBER	NUMERO DE CLIENTE CUSTOMER NUMBER	AÑO / YEAR	VEHICULO / VEHICLE	LONG. A
NI-405	2505001Y05	88-92	VELOCIMETRO SENTRA TSURU II	855
NI-415	5KS00IGI11716	-92	VELOCIMETRO PICK UP AMERICANA 6CIL.	1140



NI-406	2505034W00/01 250504BW05/06/07	1981-83	VELOCIMETRO CAMIONETAS NISSAN/DATSUN 2WD (7/81 A9/81), 4WD (10/81 A 10/82), 2WD W/SD22 ENG. (10/81) M.T	1605
--------	-----------------------------------	---------	---	------

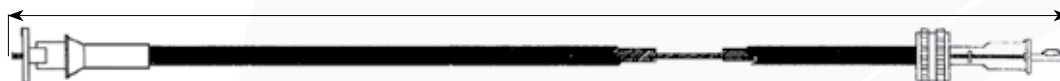

NI-408			TAXIMETRO TSURU (SIN TROQUELAR)	375
--------	--	--	---------------------------------	-----



NI-410	25050-60A04	87-	VELOCIMETRO SENTRA B12	1873
--------	-------------	-----	------------------------	------



NI-411		82-92	VELOCIMETRO TSURU I & II AUTOMATICO	2078
--------	--	-------	-------------------------------------	------

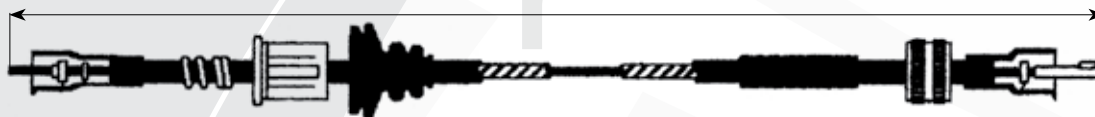

NI-412	2505060A04	88-92	VEL. TSURU II SENTRA	836
--------	------------	-------	----------------------	-----



NI-413		00-	VELOCIMETRO CAMIONETA URVAN STD 2.4 TWIN CAM	2956
--------	--	-----	--	------



\*Importante: La información indicada en esta publicación, ha sido obtenida por fuentes confiables y oficiales, consideramos que es correcta, sin embargo no asumimos ninguna responsabilidad por errores, cambios, omisiones o daños que resulten de estos.

NUMERO DE PARTE PART NUMBER	NUMERO DE CLIENTE CUSTOMER NUMBER	AÑO / YEAR	VEHICULO / VEHICLE	LONG. A
NI-414	2505055G00	96-	VEL. CAMIONETAS PICKUP-MOTOR D21 EGI 2.4L	1311

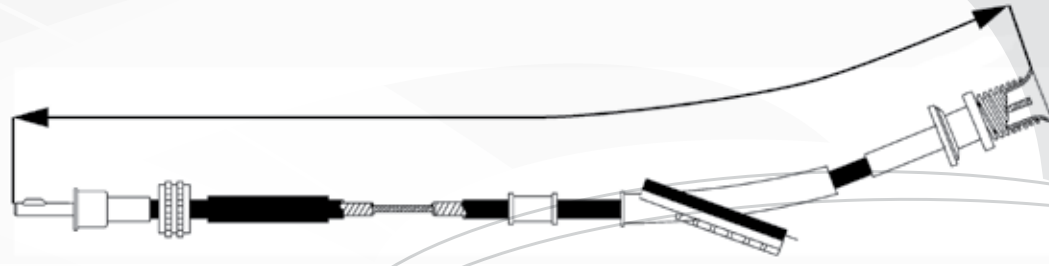

NUMERO DE PARTE PART NUMBER	NUMERO DE CLIENTE CUSTOMER NUMBER	AÑO / YEAR	VEHICULO / VEHICLE	LONG. A
PK-450			TACOMETRO PERKINS KENWORTH S.W.	1684
PK-452			TACOMETRO KW CHATO	3040



PK-451			TACOMETRO PERKINS V.D.O	1684
--------	--	--	-------------------------	------



PK-453			TACOMETRO ESPECIAL PERKINS KW (DOBLE RESORTE)	1682
--------	--	--	---	------



NUMERO DE PARTE PART NUMBER	NUMERO DE CLIENTE CUSTOMER NUMBER	AÑO / YEAR	VEHICULO / VEHICLE	LONG. A
PG-400		85-	VELOCIMETRO PEUGEOT 205, 309, 405 GT	900

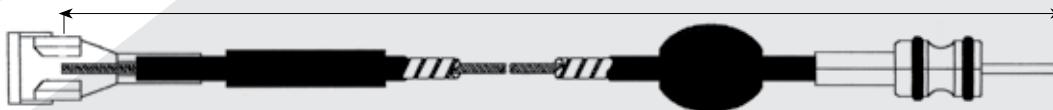

"Importante: La información indicada en esta publicación, ha sido obtenida por fuentes confiables y oficiales, consideramos que es correcta, sin embargo no asumimos ninguna responsabilidad por errores, cambios, omisiones o daños que resultaran de estos".

Cables de Velocímetro / Speedometer Cables



RENAULT

# Cables de Velocímetro / Speedometer Cables



NUMERO DE PARTE PART NUMBER	NUMERO DE CLIENTE CUSTOMER NUMBER	AÑO / YEAR	VEHICULO / VEHICLE	LONG. A
RE-400	7700535669		VEL. R12 ENTRADA DE TUERCA	1575
RE-401	8538730		VEL. R-8 R-10 (8557834)	2825



RE-403			VEL. RENAULT R5/R12/R18 ROUTIER CONECTOR AL VELOCIMETRO	1465
--------	--	--	---	------

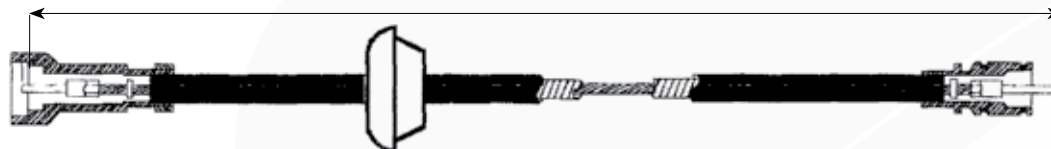

RE-404	8933001007		VEL. RENAULT ENCORE ALLIANCE	1026
--------	------------	--	------------------------------	------



SCANIA

NUMERO DE PARTE PART NUMBER	NUMERO DE CLIENTE CUSTOMER NUMBER	AÑO / YEAR	VEHICULO / VEHICLE	LONG. A
SC-400	312 625E	-	C. DE VEL. CAMION T112 / T 142 / R 112 / R 142	3595

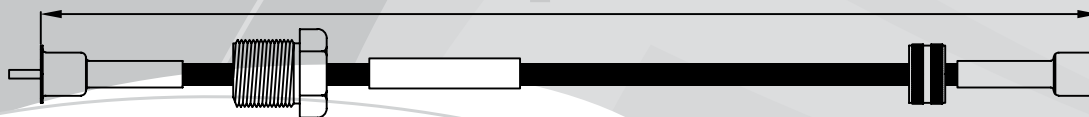

PRODUCTO NUEVO



NUMERO DE PARTE PART NUMBER	NUMERO DE CLIENTE CUSTOMER NUMBER	AÑO / YEAR	VEHICULO / VEHICLE	LONG. A
SZ-400	34910-85001		VELOCIMETRO SUZUKI CARRY	2775

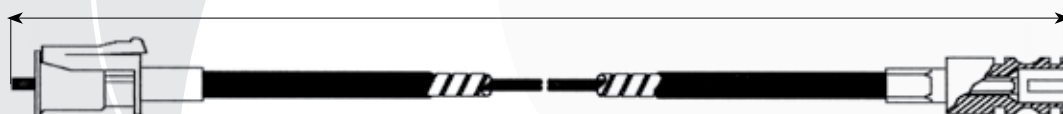

Importante: La información indicada en esta publicación, ha sido obtenida por fuentes confiables y oficiales, consideramos que es correcta, sin embargo no asumimos ninguna responsabilidad por errores, cambios, omisiones o daños que resulten de estos.

NUMERO DE PARTE PART NUMBER	NUMERO DE CLIENTE CUSTOMER NUMBER	AÑO / YEAR	VEHICULO / VEHICLE	LONG. A
TY-400	8371069106		VEL. FJ 40 L	2103
	8371012210	1968-72	VEL. CROWN	
	8371019216	1972-74	VEL. CORONA, MARK II DESDE 1/72	
	8371029186	1972-82	VEL. CORONA	
	8371014320	1973-75	VEL. CAMIONETAS LANDCRUISER WGN (HASTA 1/75) A.T.	
	8371019236	75-81	VEL. CELICA	
	8371029228	1975-83	VEL. COROLLA	
	8371014330	78-80	VEL. CRESSDA A.T.	
	8371019515	82-83	VEL. SUPRA, (83) CRESSIDA W/DIGITAL INST. PANEL	
	8371029235	1975-80	VEL. CAMIONETA HILUX CON 4 VEL M.T. Y A.T. PICK UP W4 VEL (M.T.)	
	8371014520			
	8371019516			
	8371029245			
	83710116011			
	8371010220			
	8371029345			
	8371012640			
	837102355			
	8371012650			
	837102555			

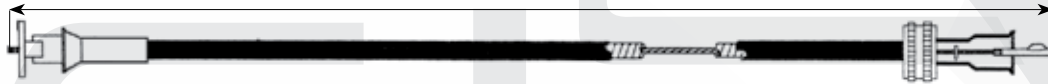

TY401	1989	C. VEL. TOYOTA AUTOMATICA 4c KING CAB 4x4	2051
-------	------	---	------

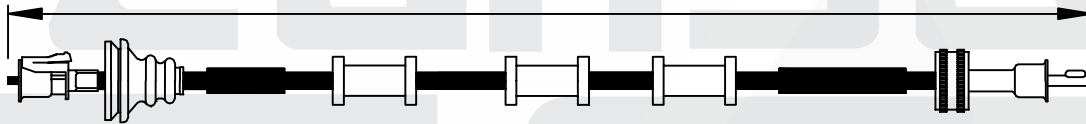

TY402	1987	C. VEL. TOYOTA 22-R 4c STD 2WD	1263
-------	------	--------------------------------	------

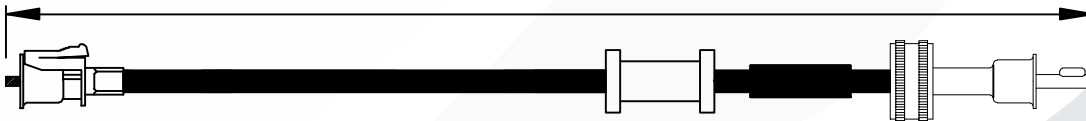

TY-403	93-99	C. DE VELOCIMETRO TOYOTA TERCEL LH	839
TY-404	89-97	C. DE VELOCIMETRO TOYOTA HILUX 4 WD 4Y / 22RE	2052

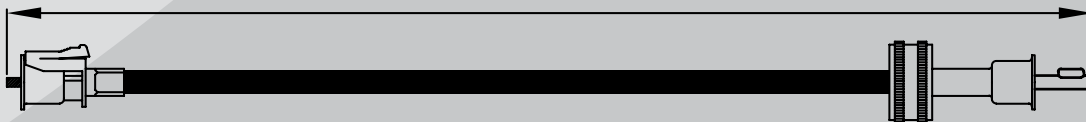

**PRODUCTO NUEVO**

"Importante: La información indicada en esta publicación, ha sido obtenida por fuentes confiables y oficiales, consideramos que es correcta, sin embargo no asumimos ninguna responsabilidad por errores, cambios, omisiones o daños que resultaran de estos".

Cables de Velocímetro / Speedometer Cables

NUMERO DE PARTE PART NUMBER	NUMERO DE CLIENTE CUSTOMER NUMBER	AÑO / YEAR	VEHICULO / VEHICLE	LONG. A
VA-400		67-73	VEL. RAMBLER AMERICAN GREMLIN ADAPTADOR TROMPO	1670

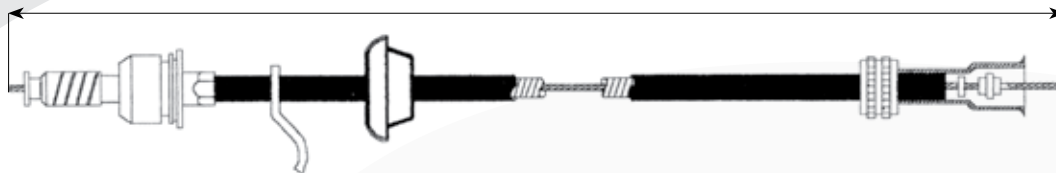

VA-401			VEL. RAMBLER AMERICAN GREMLIN ADAPTADOR PERNO	1695
--------	--	--	---	------

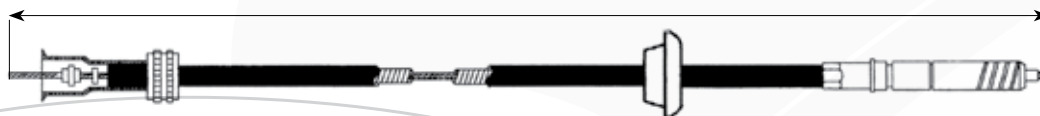

NUMERO DE PARTE PART NUMBER	NUMERO DE CLIENTE CUSTOMER NUMBER	AÑO / YEAR	VEHICULO / VEHICLE	LONG. A
VW-400	111957801F/J		VEL. SEDAN 1200/1500/1600	1230
VW-401	211957801F		VEL. TRANSPORTER COMBI	2460
VW-402	102957801I		VEL. BRASILIA	1075
VW-408	113957801A		VEL. SEDAN 1302/1302S LHD	1400
VW-409	111957801K		VEL. SEDAN 1200A/1200/1300/1300A/150LHD	1190



VW-403	171957803A/D	84-88	VEL. CARIBE ATLANTIC AUT.	1115
--------	--------------	-------	---------------------------	------



VW-404	171957803	84-88	VEL. GOLF LS & S1500 CARIBE, ATLANTIC STD.	986
--------	-----------	-------	--	-----

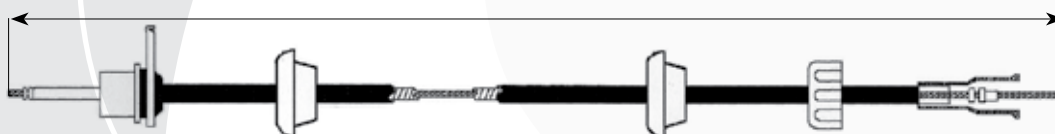

Importante: La información indicada en esta publicación, ha sido obtenida por fuentes confiables y oficiales, consideramos que es correcta, sin embargo no asumimos ninguna responsabilidad por errores, cambios, omisiones o daños que resulten de estos.

NUMERO DE PARTE PART NUMBER	NUMERO DE CLIENTE CUSTOMER NUMBER	AÑO / YEAR	VEHICULO / VEHICLE	LONG. A
VW-405	BAC957031	90-92	VEL. COMBI	2250



VW-406	BAT957031C	89-92	VEL. GOLF JETTA STD	987
--------	------------	-------	---------------------	-----



VW-407		-93	VEL. JETTA TRANSMISION AUTOMATICA	1105
VW-410	321957031AA	-87	VEL. CORSAR	1495
VW-413	171957861		VELOCIMETRO CORSAR STD. 4 CIL	1260

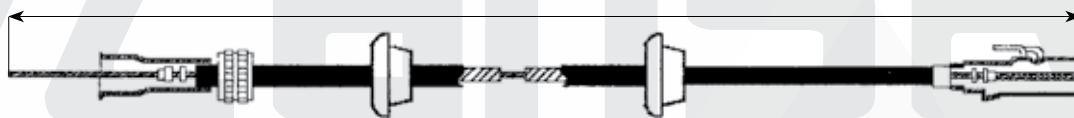

VW-411		-94	TAXIMETRO SEDAN 1200/1500/1600	1230
VW-412		94-	TAXIMETRO SEDAN 1600/1600i	1230



VW-414	300957801.1		VELOCIMETRO GOL SAVEIRO AGUA ATE 90 VOYAGER/PARATI 88	1020
VW-415	305957803.A		VELOCIMETRO SAV/GOL	1060

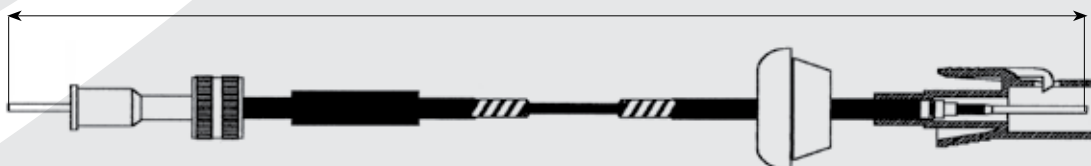

"Importante: La información indicada en esta publicación, ha sido obtenida por fuentes confiables y oficiales, consideramos que es correcta, sin embargo no asumimos ninguna responsabilidad por errores, cambios, omisiones o daños que resultaran de estos".



# Cables de Velocímetro / Speedometer Cables



NUMERO DE PARTE PART NUMBER	NUMERO DE CLIENTE CUSTOMER NUMBER	AÑO / YEAR	VEHICULO / VEHICLE	LONG. A
VW-416	377957801A	98-01	CABLE VELOCIMETRO POINTER	1106

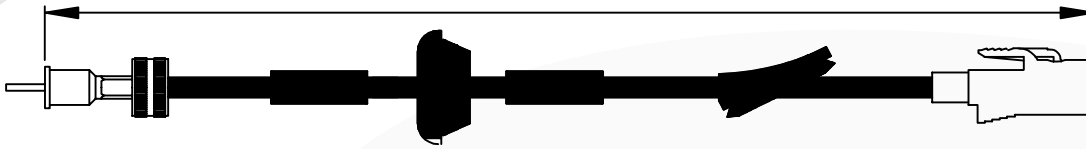

VW-417	TMJ957805	95-00	C. DE VEL. VW35 300 / 24 220 / 24 250	4145
--------	-----------	-------	---------------------------------------	------

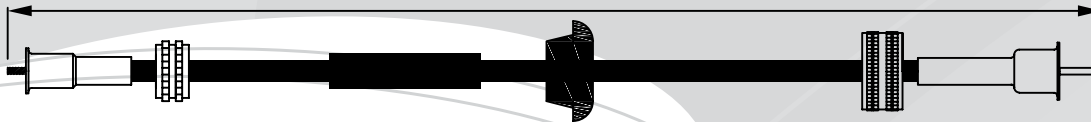

PRODUCTO NUEVO

## UNIVERSALES



NUMERO DE PARTE PART NUMBER	NUMERO DE CLIENTE CUSTOMER NUMBER	AÑO / YEAR	VEHICULO / VEHICLE	LONG. A
UN-400			VEL. UNIVERSAL DE 1.80M APROVECHABLE	1826



# Fundas de Acelerador / Accelerator Sleeves

NUMERO DE PARTE PART NUMBER	NUMERO DE CLIENTE CUSTOMER NUMBER	AÑO / YEAR	VEHICULO / VEHICLE	LONG. A
VW-502	131721551		FUNDA ACELERADOR SEDAN	615

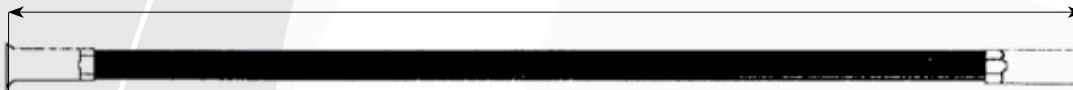

VW-503	211721551		FUNDA ACELERADOR COMBI PANEL	570
--------	-----------	--	------------------------------	-----

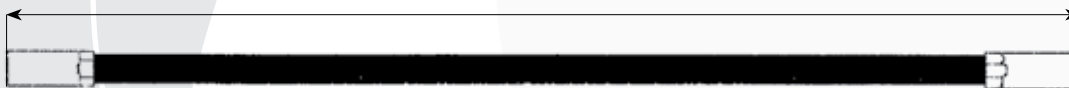

Importante: La información indicada en esta publicación, ha sido obtenida por fuentes confiables y oficiales, consideramos que es correcta, sin embargo no asumimos ninguna responsabilidad por errores, cambios, omisiones o daños que resulten de estos.

NUMERO DE PARTE PART NUMBER	NUMERO DE CLIENTE CUSTOMER NUMBER	AÑO / YEAR	VEHICULO / VEHICLE	LONG. A
VW-525			FUNDA DE EMBRAGUE HORMIGA	1500
VW-526	211721361A		FUNDA DE EMBRAGUE SEDAN 1200/1500 TERM. METAL	300
VW-527	311721361D		FUNDA DE EMBRAGUE SEDAN 1600 COMBI TERM METAL	320

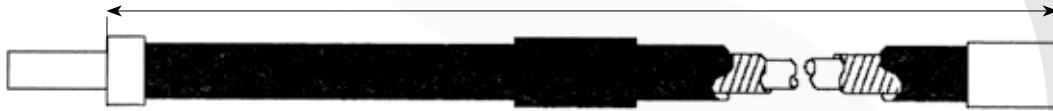

VW-528	211721361D		FUNDA DE EMBRAGUE COMBI TIPO I/ TIPO II	317
VW-529	111721361E	76-78/93	FUNDA DE EMBRAGUE SEDAN	320

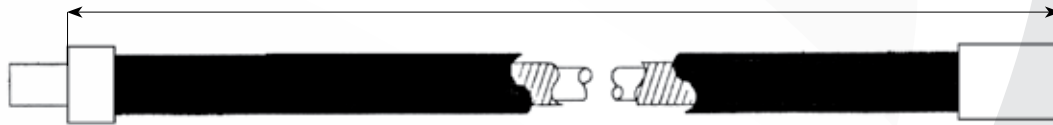

VW-532	211721361A		FUNDA DE EMBRAGUE SEDAN 1200/1500 TERM. NYLON	300
VW-533	311721361D		FUNDA DE EMBRAGUE SEDAN 1600 COMBI TERM. NYLON	320

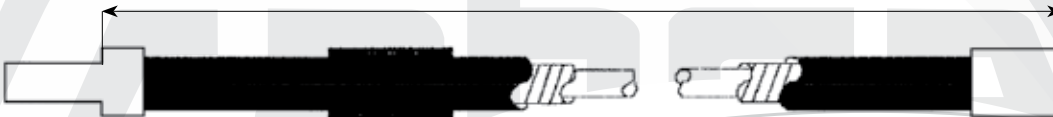

## Freno de Mano / Hand Brake



NUMERO DE PARTE PART NUMBER	NUMERO DE CLIENTE CUSTOMER NUMBER	AÑO / YEAR	VEHICULO / VEHICLE	LONG. A
CH-600	52008463	98-01	FRENO DE MANO (MEDIO) RAM 3500	864
CH-601	52009768AA	99-01	FRENO DE MANO (MEDIO) RAM 4000	1193
CH-602	52010077AA	99-01	FRENO DE MANO (MEDIO) QUAD CAB 2500	445



CH-604	4753020	94-01	FRENO DE MANO TRAS. DERECHO RAM Y PICK UP CORTA	2543
--------	---------	-------	---	------

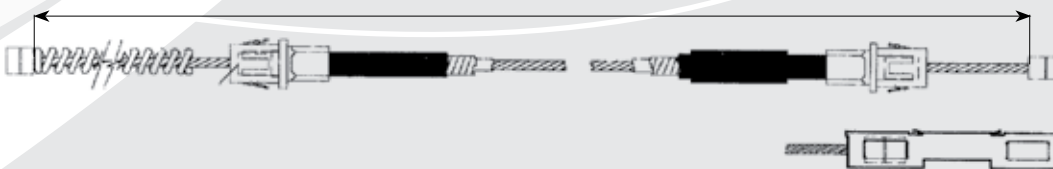

"Importante: La información indicada en esta publicación, ha sido obtenida por fuentes confiables y oficiales, consideramos que es correcta, sin embargo no asumimos ninguna responsabilidad por errores, cambios, omisiones o daños que resultaran de estos".

Fundas de Embrague / Clutch Sleeves

NUMERO DE PARTE PART NUMBER	NUMERO DE CLIENTE CUSTOMER NUMBER	AÑO /YEAR	VEHICULO /VEHICLE	LONG. A
--------------------------------	--------------------------------------	-----------	-------------------	---------

CH-605	4753021	94-01	FRENO DE MANO TRAS. IZQ. RAM Y PICK UP CORTA	920
--------	---------	-------	--	-----

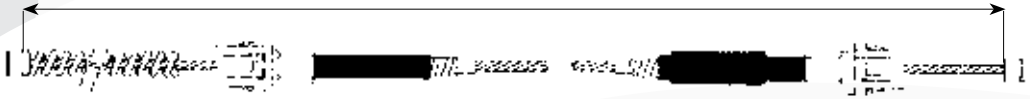

CH-606	52007523	93-	FRENO DE MANO TRAS. IZQ. JEEP WRANGLER 4 CIL.	975
--------	----------	-----	---	-----

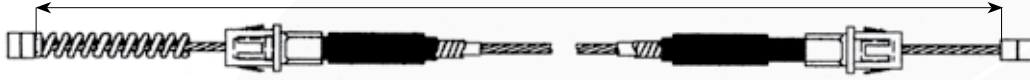

CH-607	52007522	93-	FRENO DE MANO TRAS. DERECHO JEEP WRANGLER 4 CIL.	1797
--------	----------	-----	--	------



CH-608	52008232	93-00	FRENO DE MANO TRAS. IZQ. GRAN CHEROKEE MOTOR 8 CIL.	573
--------	----------	-------	---	-----



CH-609	52007588	93-00	FRENO DE MANO TRAS. DERECHO GRAN CHEROKEE MOTOR 8 CIL.	1145
--------	----------	-------	--	------

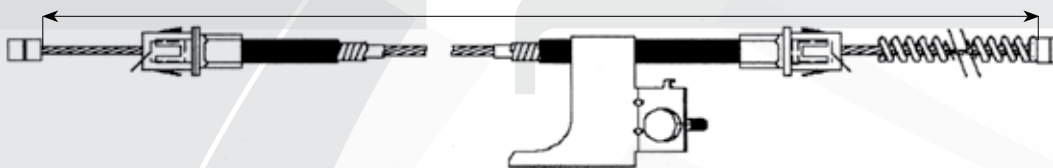

CH-610	04713350	93-00	CABLE AJUSTE AUT. P/FRENO GRAN CHEROKEE 8 CIL.	267
--------	----------	-------	--	-----

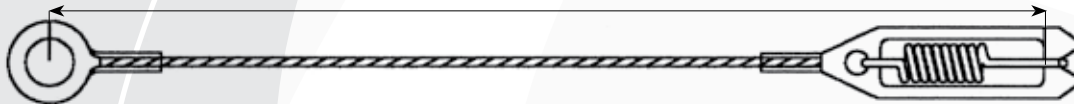

CH-611		02-07	C. FRENO TRASERO DERECHO PT CRUISER	1685
--------	--	-------	-------------------------------------	------

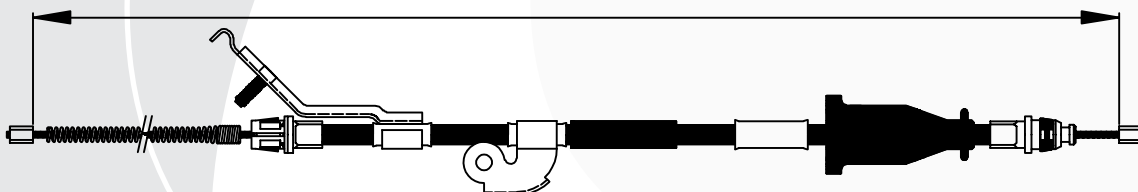

Importante: La información indicada en esta publicación, ha sido obtenida por fuentes confiables y oficiales, consideramos que es correcta, sin embargo no asumimos ninguna responsabilidad por errores, cambios, omisiones o daños que resulten de estos.

Freno de Mano /Hand Brake

NUMERO DE PARTE PART NUMBER	NUMERO DE CLIENTE CUSTOMER NUMBER	AÑO /YEAR	VEHICULO /VEHICLE	LONG. A
CH-612		02-07	C. FRENO IZQUIERDO DERECHO PT CRUISER	1718

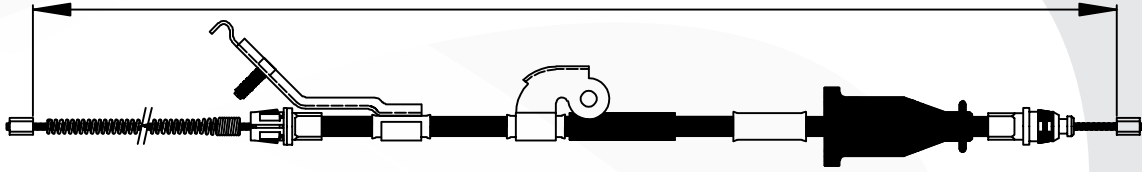

HY-600	05069943AA	2000-	FRENO DERECHO ATOS MOT 1.1	1515
--------	------------	-------	----------------------------	------

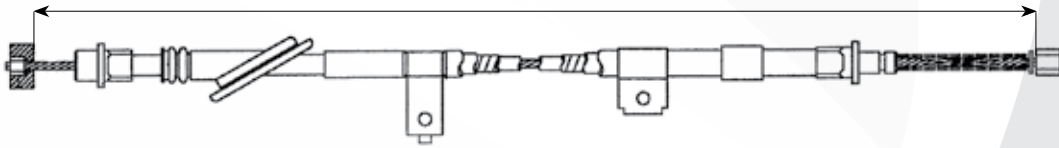

HY-601	5976002020	2000-	FRENO IZQUIERDO ATOS MOT. 1.1 (05069941AA)	1500
--------	------------	-------	--	------

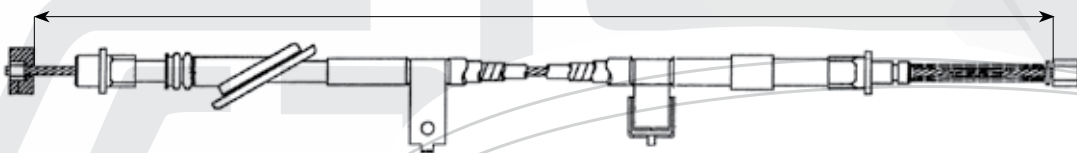

NUMERO DE PARTE PART NUMBER	NUMERO DE CLIENTE CUSTOMER NUMBER	AÑO /YEAR	VEHICULO /VEHICLE	LONG. A
FO-600		2000	TIRANTE PARA MECANISMO FRENO CAMIONETAS PICK UP LOBO & SERIES F350	277

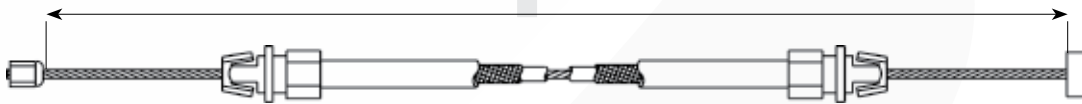

FO-601		2003	FRENO DELANTERO IKON	320
--------	--	------	----------------------	-----

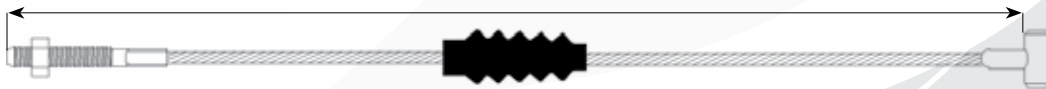

FO-602		2003	FRENO TRASERO DERECHO IKON	1630
FO-603	XS61-2A603-AG	2003	FRENO TRASERO IZQUIERDO IKON	1657



\*Importante: La información indicada en esta publicación, ha sido obtenida por fuentes confiables y oficiales, consideramos que es correcta, sin embargo no asumimos ninguna responsabilidad por errores, cambios, omisiones o daños que resultaran de estos\*.

Freno de Mano /Hand Brake



# Freno de Mano /Hand Brake



NUMERO DE PARTE PART NUMBER	NUMERO DE CLIENTE CUSTOMER NUMBER	AÑO /YEAR	VEHICULO /VEHICLE	LONG. A
FO-604	15674855	77-80	FRENO DELANTERO MERCURY: MONARCH V8 5.0L (77-79), 5.8L (77), L6 3.3L (77), 4.1L (77-79) FRENO DELANTERO MONARCH GHIA: V8 D35 5.0L, 5.8L, L6 4.1L FRENO DELANTERO FORD:GRANADA V8 5.0L (77-80), 5.8L (77), 4.2L, L6 3.3L 77, 4.1L (77-80) GRANADA GHIA V8 5.0L, 5.8L, L6 4.1L, 3.3L (1977) (EXPORTACIÓN)	1520
FO-607		98-07	C. FRENO DELANTERO FORD F350 (LOBO)	1226
FO-608		98-07	C. FRENO DELANTERO FORD F150/250 (LOBO)	1645

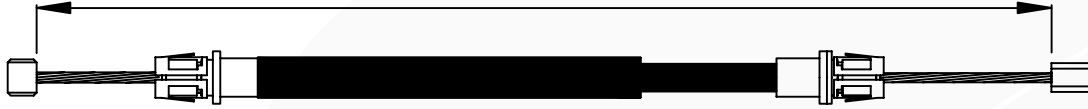

FO-605		1991	C. FNO TRAS IZQ PICK UP CABINA Y MEDIA 4.9 L 6L LARIANT F150 AMERICANA	1505
FO-609		1989	C. FRENO TRASERO DERECHO RANGER	1715

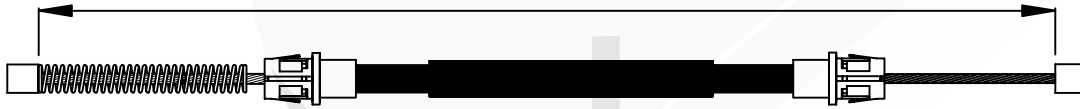

FO-606		1989	C. FRENO TRASERO IZQ FORD PICK UP RANGER	1226
--------	--	------	--	------



NUMERO DE PARTE PART NUMBER	NUMERO DE CLIENTE CUSTOMER NUMBER	AÑO /YEAR	VEHICULO /VEHICLE	LONG. A
FT-600	5969735	88-	FRENO DE MANO UNO CS-FIORINO/PREMIO/ELBA TODOS, DUNA TODOS	2835
FT-604	4328812	64-	FRENO DE MANO 131	2830



FT-601	4362077	81-	FRENO DE MANO 147/SPAZZIO/OGGO TODOS; 127,FIORINO (BRASIL) DIESEL	2306
FT-602	ARTFA2.119	-81	FRENO TRASERO FIAT 127 BRASIL PANORAMA	2307



FT-603	ARTFA2.154		FRENO TRASERO UNO/PREMIO/ELBA	2876
--------	------------	--	-------------------------------	------



Importante: La información indicada en esta publicación, ha sido obtenida por fuentes confiables y oficiales, consideramos que es correcta, sin embargo no nos asumimos ninguna responsabilidad por errores, cambios, precisiones o daños que resulten de estos.

Freno de Mano /Hand Brake







NUMERO DE PARTE PART NUMBER	NUMERO DE CLIENTE CUSTOMER NUMBER	AÑO /YEAR	VEHICULO /VEHICLE	LONG. A
GM-600	90445985	-96	FRENO DE MANO TRASERO IZQ. CHEVY CORSA	1375
GM-601	90445986	-96	FRENO DE MANO TRASERO DER. CHEVY CORSA	1076
GM-602		1989	FRENO TRASERO DERECHO LUV 1600 L. DERECHO	1680
GM-603		1989	FRENO TRASERO IZQUIERDO LUV 1600 L. IZQ.	1600
GM-604	8943667702	88-	FRENO TRASERO IZQ. M2300	1605
GM-605		2000	FRENO TRASERO CAVALIER	652
GM-606	15592925	84-91	FRENO INTERMEDIO S15 JIMMY MOT. V6 2.8L Y 4.3L, L4 1.9L,2.0L, 2.5L S10 BLAZER MOT. V6 2.8L, 4.3L, L4 1.9L,2.0L,2.2L Y 2.5L LLV (POSTAL VEHICLE) L4 2.5L (1987-1991) BRAVADA V6 4.3L (A) (EXPORTACIÓN)	143
GM607	15568341	87-91	FRENO TRASERO DERECHO CHEVROLET LLV (POSTAL VEHICLE) L4 2.5L 2474CC, 151CID, GAS FUEL INJ. MOT. E(87-91), A(91) (EXPORTACIÓN)	2160
GM608	15568342	87-95	FRENO TRASERO IZQUIERDO CHEVROLET LLV (POSTAL VEHICLE) L4 2.5L 2474CC, 151CID, GAS FUEL INJ. MOT. E(87-91), A(91-93), 4(94-95) (EXPORTACIÓN)	2040

\*Importante: La información indicada en esta publicación, ha sido obtenida por fuentes confiables y oficiales, consideramos que es correcta, sin embargo no asumimos ninguna responsabilidad por errores, cambios, omisiones o daños que resultaran de estos\*.

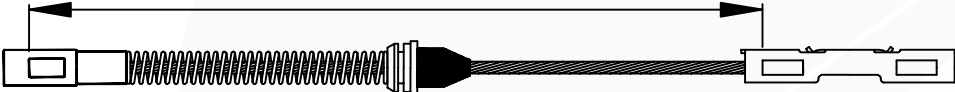

# Freno de Mano /Hand Brake

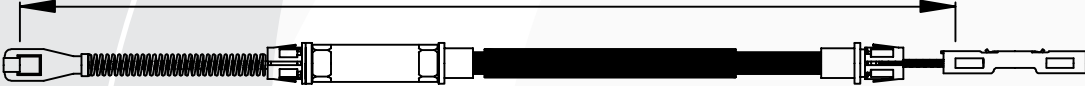

NUMERO DE PARTE PART NUMBER	NUMERO DE CLIENTE CUSTOMER NUMBER	AÑO /YEAR	VEHICULO /VEHICLE	LONG. A
GM610	14700947	76-79	FRENO DELANTERO CHEVROLET CHEVETTE L4 1.6L (76-79), L4 1.4L (76-77), CHEVETTE SCOOTER L4 1.4L (76), L4 1.6L (76-79).	2340
				
GM611		03-09	C. EXTENSION FRENO FRENO TRASERO IZQ Y DER CORSA, MERIVA Y TORNADO 1.8L	210
				
GM612		03-09	C. FRENO FRENO TRASERO DER CORSA, MERIVA Y TORNADO 1.8L	811
				
GM613	93372940	03-09	C. FRENO FRENO TRASERO IZQ CORSA, MERIVA Y TORNADO 1.8L	1085
				
GM614	10097609		C. FNO TRAS DER CHEV, CORSICA 87-89 L4 2.0L Y V6 2.8L CORSICA LT/LTZ 90-94 L4 2.2L Y V6 3.1L, CAVALIER RS/VL 92-94, L4 2.2L, CAVALIER RS/Z24 92-94 V6 3.1L PONTIAC: TEMPEST 87-89 L4 2.0L T V6 2.8L, TEMPEST 90-92 L4 2.2L y V6 3.1L, L4 2.3L (1991), SUNBIRD 92-94, L4 2.0L Y V6 3.1 L	675
				
GM615	10097610		C. FNO TRAS IZQ CHEV, CORSICA 87-89 L4 2.0L Y V6 2.8L CORSICA LT/LTZ 90-94 L4 2.2L Y V6 3.1L, CAVALIER RS/VL 92-94, L4 2.2L, CAVALIER RS/Z24 92-94 V6 3.1L PONTIAC: TEMPEST 87-89 L4 2.0 y V6 2.8L, TEMPEST 90-92 L4 2.2L y V6 3.1L, L4 2.3L (1991), SUNBIRD 92-94, L4 2.0L Y V6 3.1 L	530
				
GM616	22651234		C. FNO TRAS CHEV, CAVALIER LS/Z24, L4 2.2L/2.3L /2.4L 95-02 PONTIAC: SUNFIRE SE/GT L4 2.2L/2.3L/2.4L, 95-2002, GRAND AM SE/GT L4 2.3L Y V6 3.1L 95-98 OLDSMOBILE: ACHIEVA S/SL/SC L4 2.3L y V6 3.1L 95-98, BUICK SKYLARK CUSTOM/ LIMITED/ GRAND SPORT L4 2.3L/2.4L y V6 3.1L 95-98	653
				

"Impresión: La información indicada en esta publicación, ha sido obtenida por fuentes confiables y oficiales, consideramos que es correcta, sin embargo no asumimos ninguna responsabilidad por errores, cambios, omisiones o daños que resulten de estos."

Freno de Mano /Hand Brake

NUMERO DE PARTE PART NUMBER	NUMERO DE CLIENTE CUSTOMER NUMBER	AÑO /YEAR	VEHICULO /VEHICLE	LONG. A
GM617	93425464	95-02	C. FRENO TRAS DER CHEV, CAVALIER LS/Z24, L4 2.2L/2.3L /2.4L 95-02 PONTIAC: SUNFIRE SE/GT L4 2.2L/2.3L/2.4L, 95-2002, GRAND AM SE/GT L4 2.3L Y V6 3.1L 95-98 OLDSMOBILE: ACHIEVA S/SL/SC L4 2.3L y V6 3.1L 95-98, BUICK SKYLARK CUSTOM/ LIMITED/ GRAND SPORT L4 2.3L/2.4L y V6 3.1L 95-98	2397



GM618	C101237		C. FNO TRAS GM PASSENGER CORTO 60-70 BRAKE CONVERSION	920
GM619	C101241		C. FNO TRAS GM PASSENGER LARGO 60-70 BRAKE CONVERSION	1010

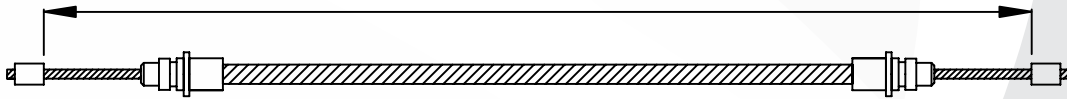

GM620		2004	C. FNO TRAS TRASERO DERECHO GRAND AM 3.4L	735
-------	--	------	---	-----



GM621		05-08	C. FNO TRASERO IZQUIERDO EQUINOX	2112
GM622		05-08	C. FNO TRASERO DERECHO EQUINOX	2175

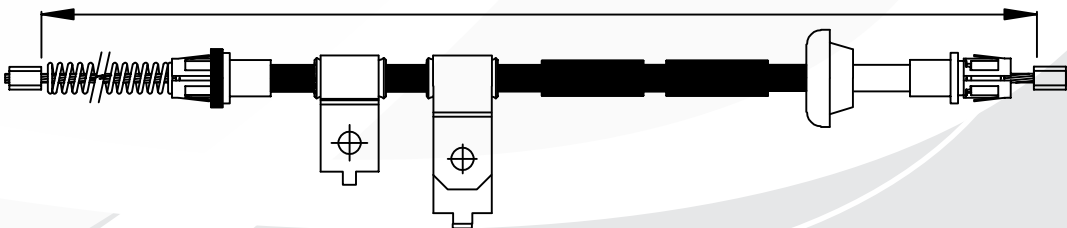

GM623	GM 1107		C. DISCO BRAKE CABLE - LONGER (EXPORTACION)	1651
GM624	GM 1108		C. DISCO BRAKE CABLE - SHORT (EXPORTACION)	1397

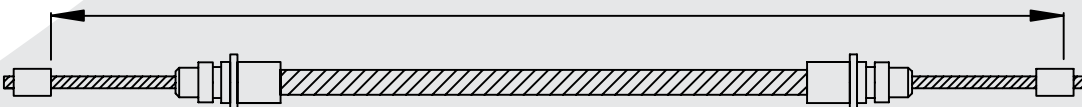

\*Importante: La información indicada en esta publicación, ha sido obtenida por fuentes confiables y oficiales, consideramos que es correcta, sin embargo no asumimos ninguna responsabilidad por errores, cambios, omisiones o daños que resultaran de estos\*.



# Freno de Mano /Hand Brake



NUMERO DE PARTE PART NUMBER	NUMERO DE CLIENTE CUSTOMER NUMBER	AÑO /YEAR	VEHICULO /VEHICLE	LONG. A
--------------------------------	--------------------------------------	-----------	-------------------	---------

GM-625	TODOS	C. FRENO DELANTERO LUV mot ISUZU	290
--------	-------	----------------------------------	-----

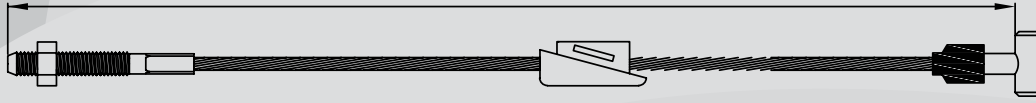

PRODUCTO NUEVO

GM-626	TODOS	LIB. FRENO DELANTERO SILVERADO, SUBURBAN PICK UP SERIE C/K 6Y 8 CIL.	350
--------	-------	---	-----

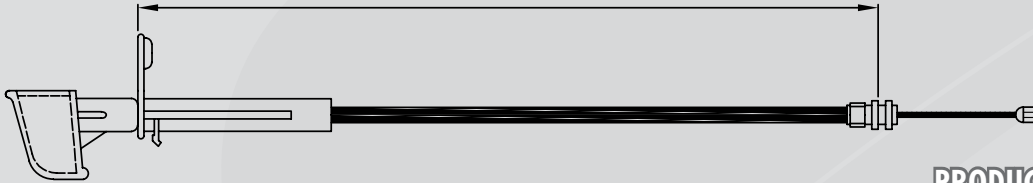

PRODUCTO NUEVO

GM-627	2011-	C. FRENO TRASERO DER. SPARK 1.2 L	1443
--------	-------	-----------------------------------	------

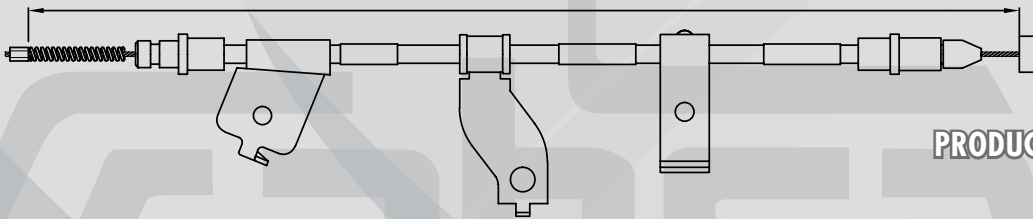

PRODUCTO NUEVO

GM-628	2011-	C. FRENO TRASERO IZQ. SPARK 1.2 L	1443
--------	-------	-----------------------------------	------

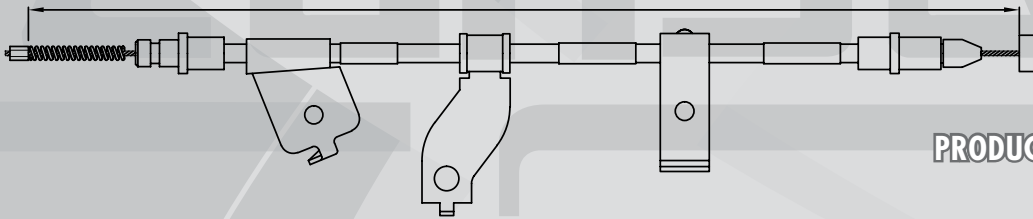

PRODUCTO NUEVO

GM-629	2011-	C. FRENO DELANTERO SPARK 1.2 L	330
--------	-------	--------------------------------	-----

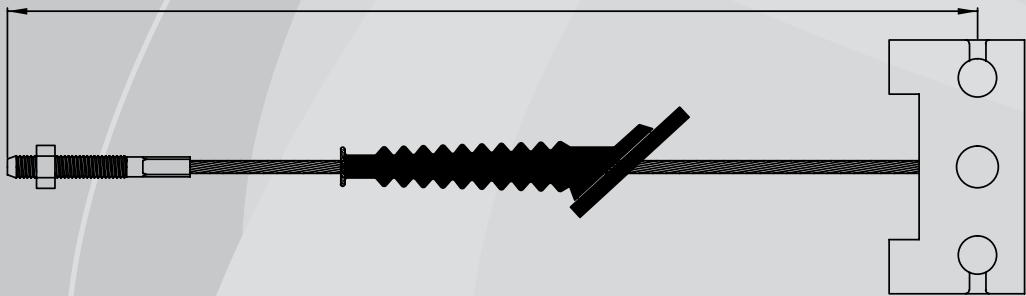

PRODUCTO NUEVO

GM-630	89-	C. DE FRENO TRASERO CHEVROLET LUV 2.3L DER.	1685
GM-631	89-	C. DE FRENO TRASERO CHEVROLET LUV 2.3L IZQ.	1700

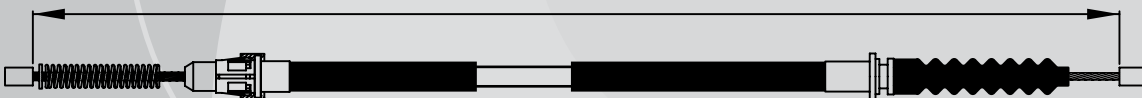

PRODUCTO NUEVO

Importante: La información indicada en esta publicación, ha sido obtenida por fuentes confiables y oficiales, consideramos que es correcta, sin embargo no asumimos ninguna responsabilidad por errores, omisiones o daños que resulten de estos.

Freno de Mano /Hand Brake

NUMERO DE PARTE PART NUMBER	NUMERO DE CLIENTE CUSTOMER NUMBER	AÑO / YEAR	VEHICULO / VEHICLE	LONG. A
HY-600	05069943AA	2000-	FRENO DERECHO ATOS MOT 1.1	1515



HY-601	5976002020	2000-	FRENO IZQUIERDO ATOS MOT. 1.1 (05069941AA)	1500
--------	------------	-------	--	------

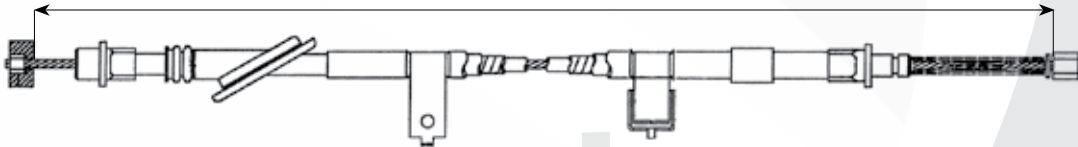

HY-602	59911-43450		C. FNO TRAS IZQ - GRACE (EXTRA LONG-15 PASAJEROS)	2037
--------	-------------	--	---	------

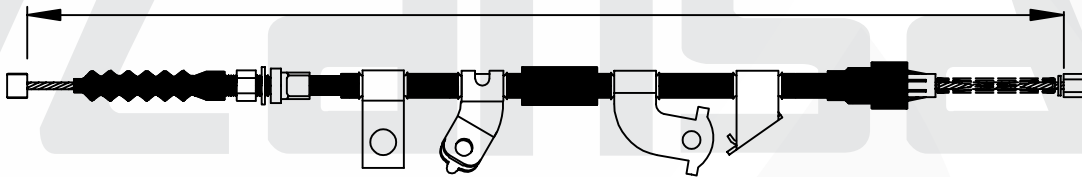

HY-603	59912-43450		C. FNO TRAS DER - GRACE (EXTRA LONG-15 PASAJEROS)	2630
--------	-------------	--	---	------

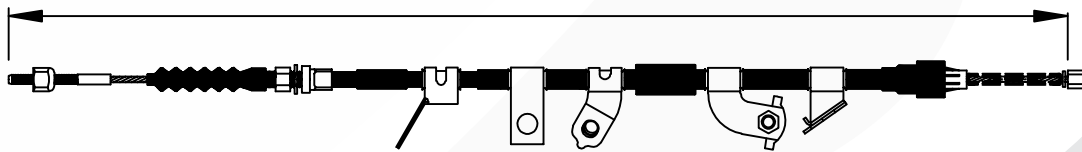

HY-604	5991148164	2003-	C. FNO TRASERO CAMIONETA H100	3975
--------	------------	-------	-------------------------------	------

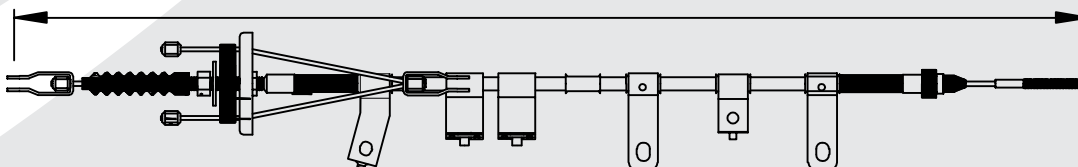

"Importante: La información indicada en esta publicación, ha sido obtenida por fuentes confiables y oficiales, consideramos que es correcta, sin embargo no asumimos ninguna responsabilidad por errores, cambios, omisiones o daños que resultaran de estos".

NUMERO DE PARTE PART NUMBER	NUMERO DE CLIENTE CUSTOMER NUMBER	AÑO /YEAR	VEHICULO /VEHICLE	LONG. A
MZ-600	8L2B44203B		FRENO DE MANO TRAS. IZQUIERDO 323 NX C/RESORTE	1528



MZ-601	8L2B44007A		FRENO DE MANO TRAS. DERECHO 323 NX S/RESORTE	1435
--------	------------	--	--	------

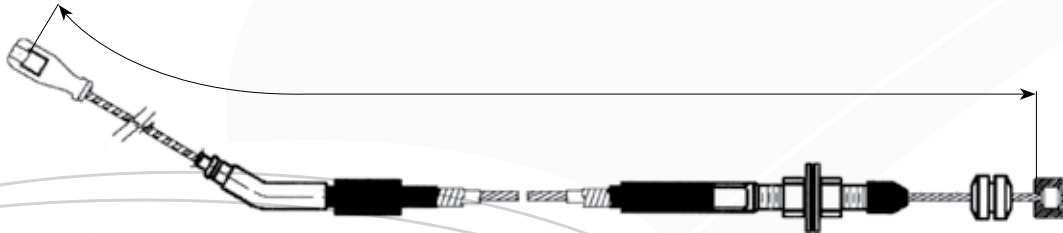

NUMERO DE PARTE PART NUMBER	NUMERO DE CLIENTE CUSTOMER NUMBER	AÑO /YEAR	VEHICULO /VEHICLE	LONG. A
NI-600	36530 01A01	84-88	FRENO DE MANO DERECHO TRASERO TSURU I	890



NI-601	36531 01A01	84-88	FRENO DE MANO IZQUIERDO TRASERO TSURU I	1090
--------	-------------	-------	---	------

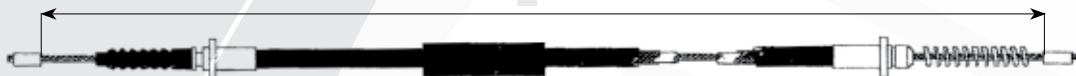

NI-602	36402 01A00	84-88	FRENO DE MANO DELANTERO TSURU I	544
--------	-------------	-------	---------------------------------	-----

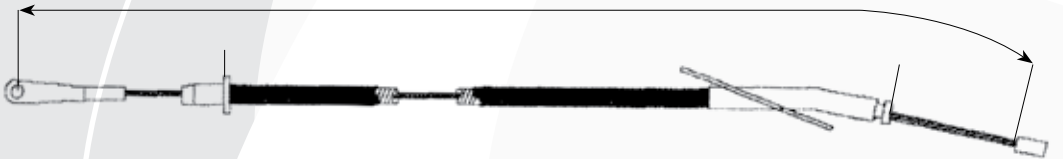

NI-603	36530 50M01	88-92	FRENO DE MANO TRASERO DERECHO TSURU II	1442
NI-604	36531 50M01	88-92	FRENO TRASERO IZQUIERDO TSURU II	1442



Importante: La información indicada en esta publicación, ha sido obtenida por fuentes confiables y oficiales, consideramos que es correcta, sin embargo no asumimos ninguna responsabilidad por errores, cambios, omisiones o daños que resulten de estos.

Freno de Mano /Hand Brake

NUMERO DE PARTE PART NUMBER	NUMERO DE CLIENTE CUSTOMER NUMBER	AÑO / YEAR	VEHICULO / VEHICLE	LONG. A
NI-605	36402 51E00	88-92	FRENO DE MANO DELANTERO TSURU II	320

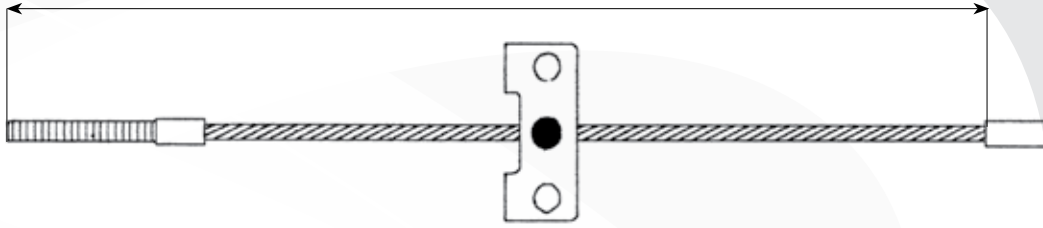

NI-606	36530-50Y10	93-	FRENO TRASERO DERECHO TSURU III, TSURU V16 LE SUNNY PULSAR 1.4/1.6 DS	1410
--------	-------------	-----	---	------

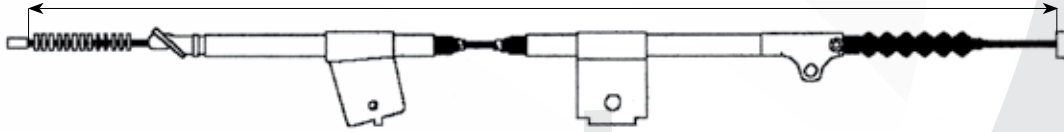

NI-607	36531-50Y10	93-	FRENO TRASERO IZQUIERDO TSURU III, TSURU V16 LE SUNNY PULSAR 1.4/1.6 DS	1410
--------	-------------	-----	---	------

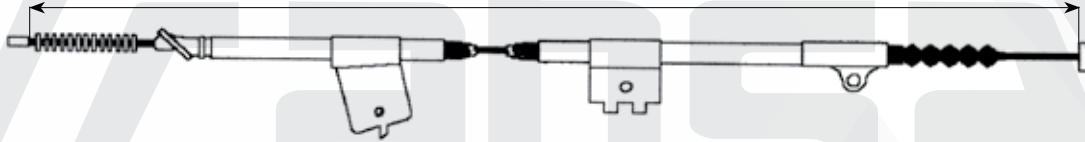

NI-608	36402 50J10	93-	FRENO DE MANO DELANTERO TSURU III, TSURU VI LT SUNNY PULSAR 1.4/1.6 D-S	248
--------	-------------	-----	---	-----



NI-609	36530 04W00	-94	FRENO DE MANO TRASERO DERECHO PICK UP (CORTA)	1453
NI-612	36530 04W10	-94	FRENO DE MANO TRASERO DERECHO PICK UP (LARGA)	1682

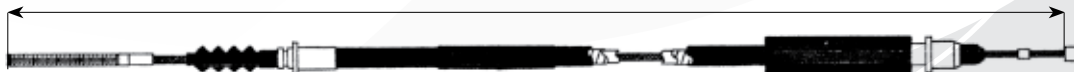

NI-610	36531 04W00	-94	FRENO DE MANO TRASERO IZQUIERDO PICK UP (CORTA)	1244
--------	-------------	-----	---	------

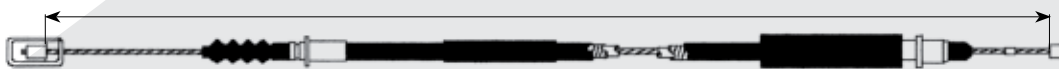

\*Importante: La información indicada en esta publicación, ha sido obtenida por fuentes confiables y oficiales, consideramos que es correcta, sin embargo no asumimos ninguna responsabilidad por errores, cambios, omisiones o daños que resultaran de estos\*.

Freno de Mano / Hand Brake

NUMERO DE PARTE PART NUMBER	NUMERO DE CLIENTE CUSTOMER NUMBER	AÑO /YEAR	VEHICULO /VEHICLE	LONG. A
NI-611	36400-04W01	-94	FRENO DE MANO DELANTERO PICK UP (LARGA Y CORTA)	2228



NI-613	36531 04W10	-94	FRENO DE MANO TRASERO IZQUIERDO PICK UP (LARGA)	1476
--------	-------------	-----	---	------

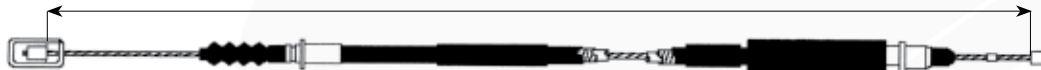

NI-614	36402 W5000	79-83	FRENO DE MANO DATSUN SEDAN	669
--------	-------------	-------	----------------------------	-----



NI-615	36400 W5801	79-83	FRENO DELANTERO DATSUN SEDAN	1240
--------	-------------	-------	------------------------------	------

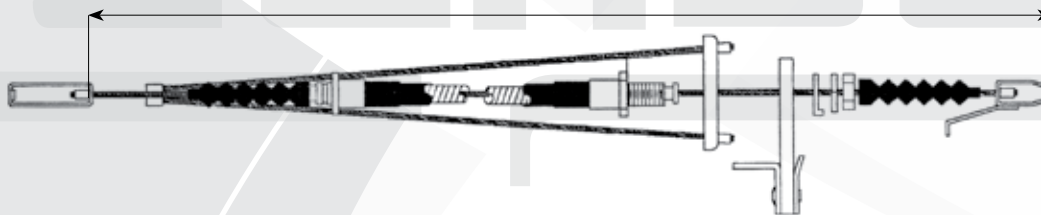

NI-616	36402 04C01	87-89	FRENO DE MANO DELANTERO ICHI-VAN	2807
--------	-------------	-------	----------------------------------	------



NI-617	36531 08G10	86-91	FRENO TRASERO IZQUIERDO PICK UP D21 2WD	2323
--------	-------------	-------	---	------

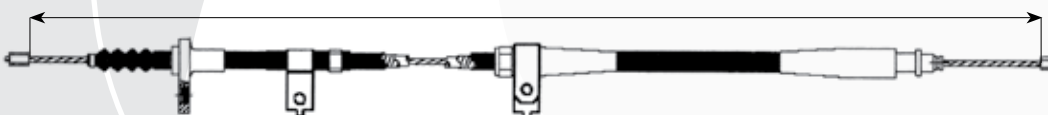

Importante: La información indicada en esta publicación, ha sido obtenida por fuentes confiables y oficiales, consideramos que es correcta, sin embargo no asumimos ninguna responsabilidad por errores, cambios, omisiones o daños que resulten de estos.

Freno de Mano /Hand Brake

NUMERO DE PARTE PART NUMBER	NUMERO DE CLIENTE CUSTOMER NUMBER	AÑO /YEAR	VEHICULO /VEHICLE	LONG. A
NI-618	36402 08G00	86-91	FRENO DE MANO DELANTERO PICK UP D21 LD	1192

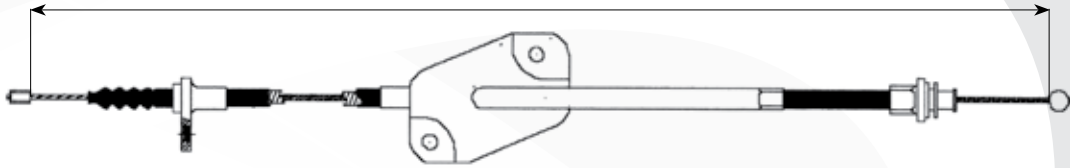

NI-619	36530 08G00	86-91	FRENO TRASERO DERECHO PICK UP D21 2WD LE	1244
--------	-------------	-------	--	------

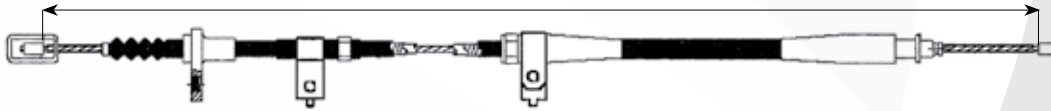

NI-620	36402 07C10	-90	FRENO DE MANO DELANTERO ICHIVAN C-110 4 CIL.	3140
--------	-------------	-----	--	------



NI-621	36400 04C00	-90	FRENO DE MANO TRASERO ICHIVAN C110 4 CIL	1872
--------	-------------	-----	--	------

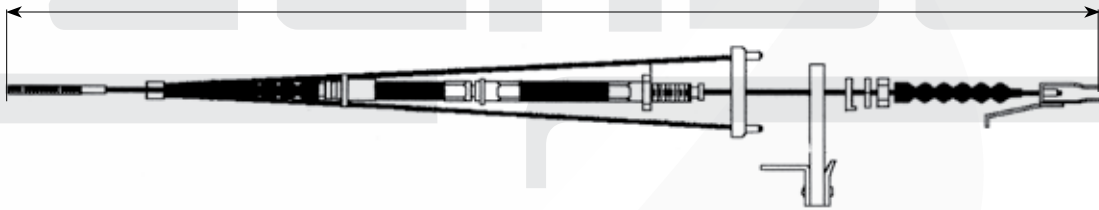

NI-622		2000-	FRENO DELANTERO CAMIONETA URVAN STD 2.4 TWIN CAM	1280
--------	--	-------	--	------

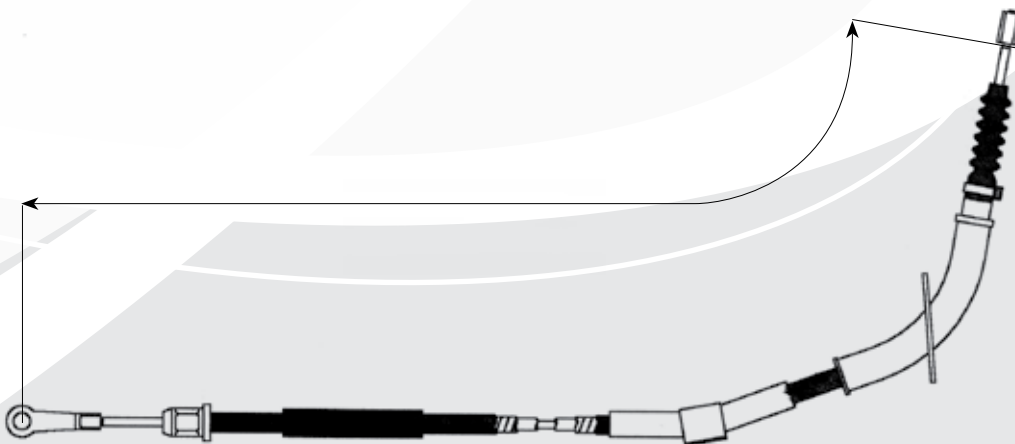

"Importante: La información indicada en esta publicación, ha sido obtenida por fuentes confiables y oficiales, consideramos que es correcta, sin embargo no asumimos ninguna responsabilidad por errores, cambios, omisiones o daños que resultaran de estos".

NUMERO DE PARTE PART NUMBER	NUMERO DE CLIENTE CUSTOMER NUMBER	AÑO / YEAR	VEHICULO / VEHICLE	LONG. A
NI-623	3640443N05	2000-	FRENO INTERMEDIO CAMIONETA URVAN STD 2.4 TWIN CAM	2148



NI-624	3653005N00	2000-	FRENO TRAS. DER. URVAN STD 2.4 TWIN CAM	1240
--------	------------	-------	---	------

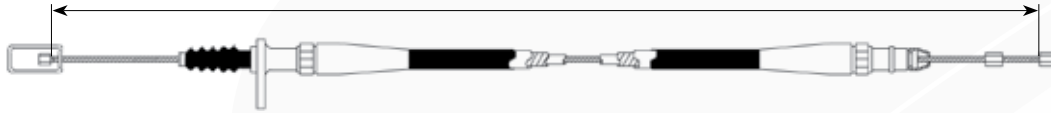

NI-625	3653145N00	2000-	FRENO TRAS IZQ CAMIONETA URVAN STD 2.4 TWIN CAM	915
--------	------------	-------	---	-----



NI-626	36531 00 QAA	2000-	FRENO TRASERO IZQ. PLATINA STD 1.6L	1335
NI-627	36530 00 QAA	2000-	FRENO TRASERO DER. PLATINA STD 1.6L	1417

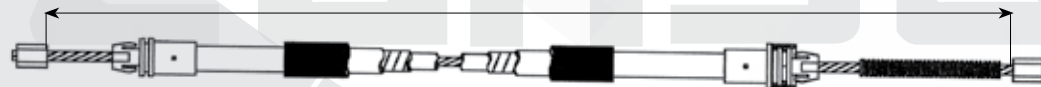

NI-628	36530-08G10	93,96-03	FRENO TRASERO DERECHO PICK UP D21 CABINA LARGA	1727
--------	-------------	----------	--	------

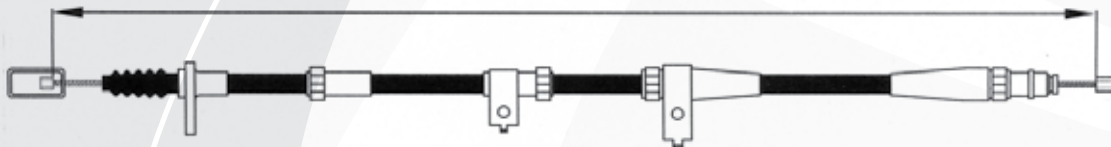

NI-629	36531-08G00	94-01	C. FNO TRAS IZQ PICK UP D21 CABINA CORTA	2030
--------	-------------	-------	--	------

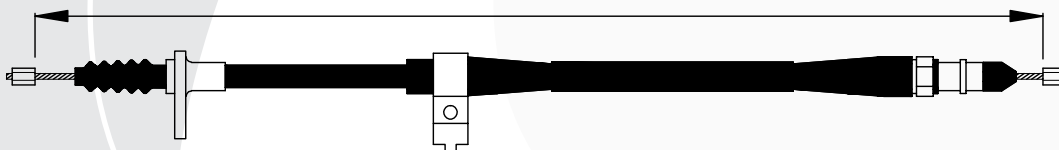

Importante: La información indicada en esta publicación, ha sido obtenida por fuentes confiables y oficiales, consideramos que es correcta, sin embargo no asumimos ninguna responsabilidad por errores, cambios, omisiones o daños que resulten de estos.

NUMERO DE PARTE PART NUMBER	NUMERO DE CLIENTE CUSTOMER NUMBER	AÑO /YEAR	VEHICULO /VEHICLE	LONG. A
NI-630	36530-4B005	96-00	C. FNO TRASERO DERECHO DERECHO SENTRA B-14	1657

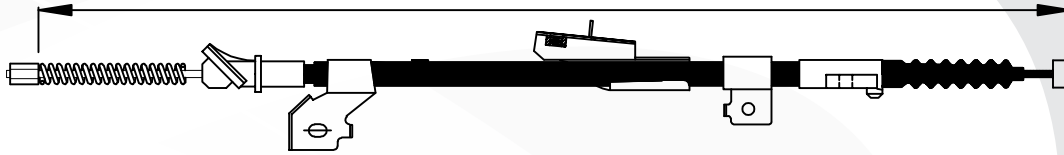

NI-631	36531-4B005	96-00	C. FNO TRASERO IZQUIERDO SENTRA B-14	1657
--------	-------------	-------	--------------------------------------	------

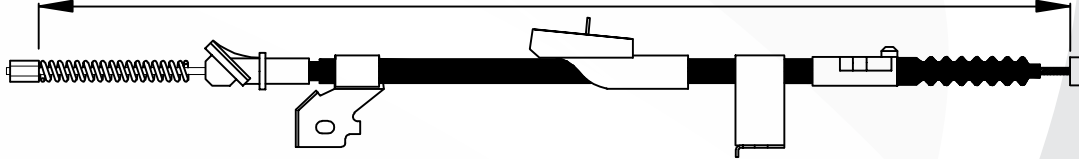

NI-632	36402-EM10A	2006-	C. FNO DELANTERO NISSAN TIIDA 1.8L	217
--------	-------------	-------	------------------------------------	-----

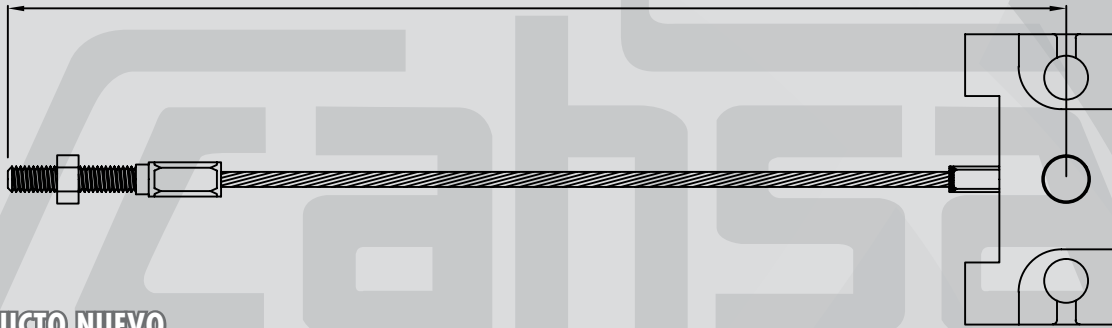

**PRODUCTO NUEVO**

NI-633	36530-EL000	2006-	C. FNO TRAS DERECHO TIIDA 1.8L	1783
--------	-------------	-------	--------------------------------	------

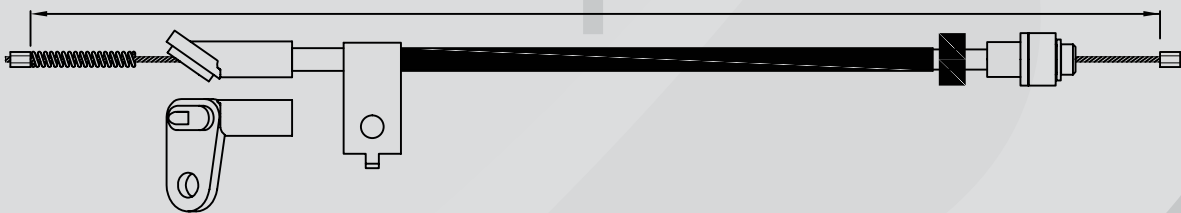

**PRODUCTO NUEVO**

NI-634	36531-EL000	2006-	C. FNO TRAS IZQUIERDO TIIDA 1.8L	1695
--------	-------------	-------	----------------------------------	------

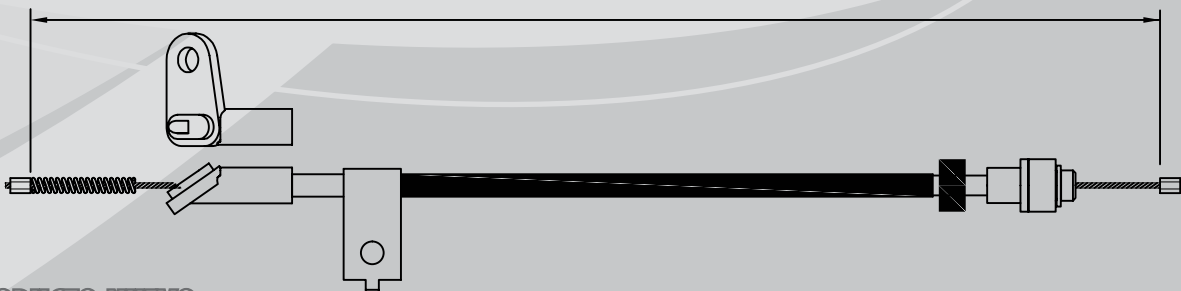

**PRODUCTO NUEVO**

"Importante: La información indicada en esta publicación, ha sido obtenida por fuentes confiables y oficiales, consideramos que es correcta, sin embargo no asumimos ninguna responsabilidad por errores, cambios, omisiones o daños que resultaran de estos".

NUMERO DE PARTE PART NUMBER	NUMERO DE CLIENTE CUSTOMER NUMBER	AÑO /YEAR	VEHICULO /VEHICLE	LONG. A
NV-600	593352C91		FRENO DE MANO NAVISTAR	1600
NV-601	593352C91 (55")		FRENO DE MANO NAVISTAR	1397

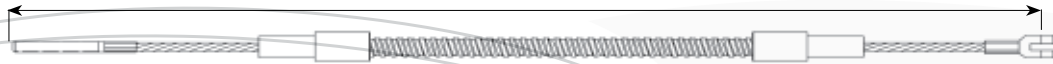

**PEUGEOT**

NUMERO DE PARTE PART NUMBER	NUMERO DE CLIENTE CUSTOMER NUMBER	AÑO /YEAR	VEHICULO /VEHICLE	LONG. A
PG-600	4745T3		FRENO DE ESTACIONAMIENTO PEUGEOT 307	2035

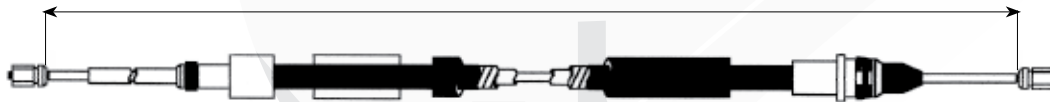

PG-601	4745N4	2001-	FRENO PEUGEOT 206	1635
--------	--------	-------	-------------------	------



PG-602		TODOS	C. FRENO TRASERO IZQUIERDO PEUGEOT 206	1745
PG-603		TODOS	C. FRENO TRASERO DERECHO PEUGEOT 206	1850

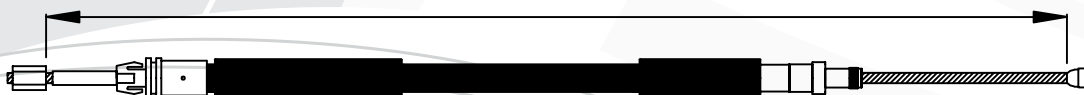

**RENAULT**

NUMERO DE PARTE PART NUMBER	NUMERO DE CLIENTE CUSTOMER NUMBER	AÑO /YEAR	VEHICULO /VEHICLE	LONG. A
RE-600		72-73	FRENO DE MANO R-12 TL	2025
RE-601			FRENO DE MANO R-12 TL ROUTIER	2180



Importante: La información indicada en esta publicación, ha sido obtenida por fuentes confiables y oficiales, consideramos que es correcta, sin embargo no asumimos ninguna responsabilidad por errores, cambios, omisiones o daños que resulten de estos.

NUMERO DE PARTE PART NUMBER	NUMERO DE CLIENTE CUSTOMER NUMBER	AÑO /YEAR	VEHICULO /VEHICLE	LONG. A
SZ600	5464070A00000		C. FRENO TRAS IZQ LARGO SAMURAI (VERSION AMERICANA)	1663



NUMERO DE PARTE PART NUMBER	NUMERO DE CLIENTE CUSTOMER NUMBER	AÑO /YEAR	VEHICULO /VEHICLE	LONG. A
TY-600	4641060320	75	FRENO DE MANO FJ/BJ/HJ	2386



TY-601	4641035500	80-85	FRENO DE MANO DELANTERO TOYOTA LN/YN	1181
--------	------------	-------	--------------------------------------	------



TY-602	4641035250	85	FRENO DE MANO TRASERO TOYOTA RN/LN	2019
--------	------------	----	------------------------------------	------



TY-603	46430 35210		FRENO TRASERO LN50/51/YN	1711
--------	-------------	--	--------------------------	------

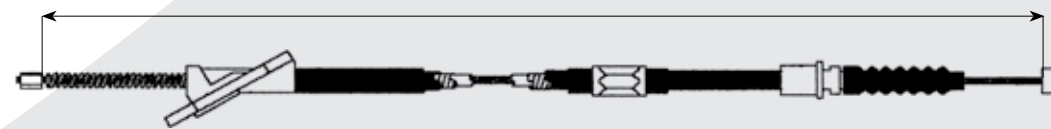

"Importante: La información indicada en esta publicación, ha sido obtenida por fuentes confiables y oficiales, consideramos que es correcta, sin embargo no asumimos ninguna responsabilidad por errores, cambios, omisiones o daños que resultaran de estos".

Freno de Mano /Hand Brake

NUMERO DE PARTE PART NUMBER	NUMERO DE CLIENTE CUSTOMER NUMBER	AÑO /YEAR	VEHICULO /VEHICLE	LONG. A
TY-604	46410 35570	89-94	FRENO DELANTERO TOYOTA PICK UP KING CAB 4x4	2400
TY-605		89-94	FRENO DELANTERO TOYOTA PICK UP 4x4	2190
TY-608		90-06	C. FRENO	1432
TY-609	4641035580	88-	C. FRENO TRASERO HILUX LN111	2393



TY-606		03-05	C. FRENO DELANTERO RAV4 4 CIL 2.4L	410
--------	--	-------	------------------------------------	-----

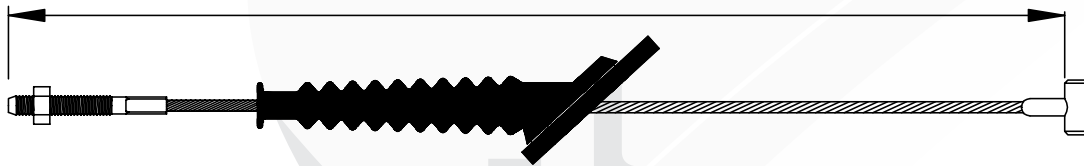

TY-607	4641035151	78-83	C. FRENO DELANTERO HILUX RN30-LN30	1212
--------	------------	-------	------------------------------------	------



TY-610		95-00	C. FRENO MANO TOYOTA TACOMA 4 CIL. 2.7L 4x4 KING CAB 2820	2820
--------	--	-------	---	------

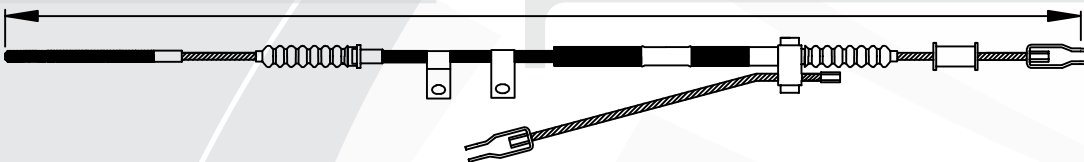

TY-611		1991	C. FRENO TRASERO TOYOTA 4X4 KING CAB	2300
--------	--	------	--------------------------------------	------

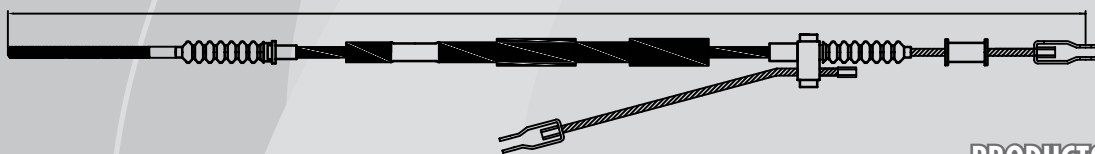

**PRODUCTO NUEVO**

TY-612		95-99	C. DE FRENO TRASERO IZQUIERDO TOYOTA TERCEL	1680
--------	--	-------	---	------

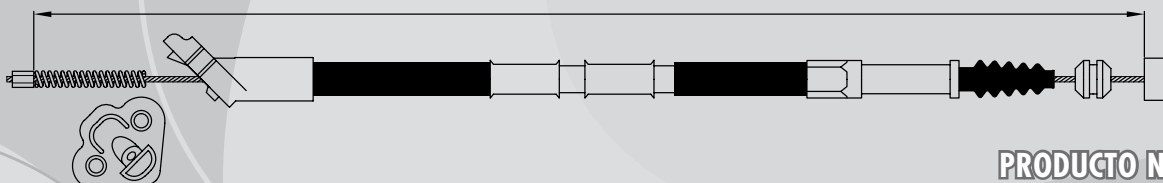

**PRODUCTO NUEVO**

Importante: La informacion indicada en esta publicacion, ha sido obtenida por fuentes confiables y oficiales, consideramos que es correcta, sin embargo no nos asumimos ninguna responsabilidad por errores, cambios, omisiones o daños que resulten de estos.

Freno de Mano /Hand Brake

NUMERO DE PARTE PART NUMBER	NUMERO DE CLIENTE CUSTOMER NUMBER	AÑO /YEAR	VEHICULO /VEHICLE	LONG. A
UN-600			FRENO TRASERO AMC CHRYSLER, FORD, GM, DODGE, AUTOS, CAMIONES Y CAMIONETAS (370100)	3060



UN-601			FRENO INTERMEDIO CAMIONETAS Y CAMIONES DODGE, FORD & CHRYSLER (370106)	2730
--------	--	--	--	------

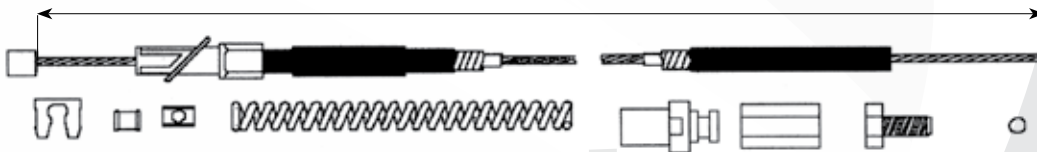

UN-602			FRENO TRASERO CAMIONETA AMERICANA AMC CHRYSLER, FORD, GM, DODGE, AUTOS, CAMIONES Y CAMIONETAS (370400)	2710
--------	--	--	--	------



UN-603			FRENO INTERMEDIO AUTOS FORD; CAMIONES Y CAMIONETAS DODGE, FORD, GM	4100
--------	--	--	--	------

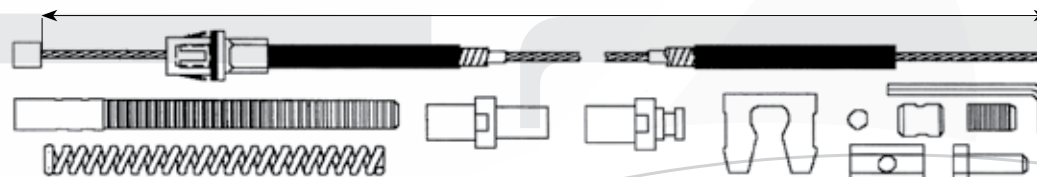

NUMERO DE PARTE PART NUMBER	NUMERO DE CLIENTE CUSTOMER NUMBER	AÑO /YEAR	VEHICULO /VEHICLE	LONG. A
VW-600	113609721F		FRENO DE MANO SEDAN 1200-1500	1790
VW-603	133609721		FRENO DE MANO SEDAN 1600	1750

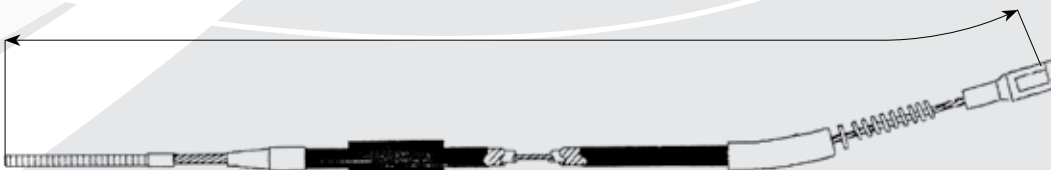

"Importante: La información indicada en esta publicación, ha sido obtenida por fuentes confiables y oficiales, consideramos que es correcta, sin embargo no asumimos ninguna responsabilidad por errores, cambios, omisiones o daños que resultaran de estos".

Freno de Mano /Hand Brake



# Freno de Mano /Hand Brake



NUMERO DE PARTE PART NUMBER	NUMERO DE CLIENTE CUSTOMER NUMBER	AÑO /YEAR	VEHICULO /VEHICLE	LONG. A
--------------------------------	--------------------------------------	-----------	-------------------	---------

VW-601	211609701Q		FRENO DE MANO COMBI	2950
--------	------------	--	---------------------	------



VW-601F	211609701F	63-67	FRENO DE MANO TIPO II	3453
---------	------------	-------	-----------------------	------



VW-602	171609721B		FRENO DE MANO CARIBE ATLANTIC	1695
VW-602C	171609721C	76-84	FRENO DE MANO CARIBE SCIROCCO JETTA	1635



VW-604	113609721B		FRENO DE MANO SEDAN 1200	1915
VW-610	311609721	61-65	FRENO DE MANO 1500 N/S VARIANT GHIA	1690
VW-616	113609721L	64-72	FRENO DE MANO VW SEDAN MOTOR 1200, 1300, 1500 & GHIA 1302/1325	1779
VW-617	113609721M	67-72	FRENO DE MANO VW SEDAN MOTOR 1200, 1300, 1500 TYPE I	1773



VW-605	191609721E	88-92	FRENO DE MANO JETTA/GOLF EXPORTACION (16M609721E)	1535
VW-606	191609721	88-92	FRENO DE MANO GOLF	1735
VW-609	175609721	79-87	FRENO DE MANO CARIBE (USA) JETTA/ SCIROCCO CABRIOLET	1635

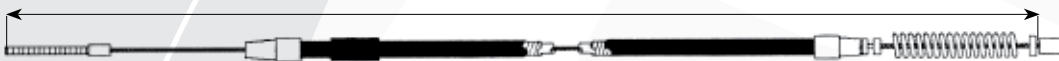

VW-613	211609701T	8/87-	FRENO DE MANO COMBI 1.7L	2960
--------	------------	-------	--------------------------	------



VW-614	211609701L		FRENO DE MANO COMBI 1.2, 1.5, 1.6 L VAN, CAMIONET, BUS, OMNIBUS	3433
--------	------------	--	---	------



Importante: La información indicada en esta publicación, ha sido obtenida por fuentes confiables y oficiales, consideramos que es correcta, sin embargo no asumimos ninguna responsabilidad por errores, cambios, omisiones o daños que resulten de estos.

Freno de Mano /Hand Brake

NUMERO DE PARTE PART NUMBER	NUMERO DE CLIENTE CUSTOMER NUMBER	AÑO /YEAR	VEHICULO /VEHICLE	LONG. A
VW-615	191609721D	6/87-	FRENO DE MANO GOLF GTI/JETTA GLI	1835
VW-618	179609721	9/83	FRENO DE MANO CADDY II	2018
VW-619	3056097211		FRENO DE MANO SANTANA CORSAR ATLANTIC	2562
VW-620	179609721	-95	FRENO DE MANO DERBY S4	1510
VW-621	1HM609721A	93-2000	FRENO GOLF JETTA A3	1613
VW-622	3776097221	98-2000	FRENO POINTER	2945
VW623	7DI609555	2001-	FRENO EUROVAN MOTOR 1,8L	940
VW624	1HO 609 721E	93-99 99-02	FRENO GOLF, JETTA 93-99 GOLF, JETTA A4, CABRIO	1613

"Importante: La información indicada en esta publicación, ha sido obtenida por fuentes confiables y oficiales, consideramos que es correcta, sin embargo no asumimos ninguna responsabilidad por errores, cambios, omisiones o daños que resultaran de estos".



# Freno de Mano /Hand Brake



NUMERO DE PARTE PART NUMBER	NUMERO DE CLIENTE CUSTOMER NUMBER	AÑO /YEAR	VEHICULO /VEHICLE	LONG. A
VW625	1J0 609 721 AD	98-04	FRENO NEW BEETLE, BORA (1J2)	1695
	1J0 609 721K		JETTA A4, NEW BEETLE	
	1J0 609 721E		JETTA A4, NEW BEETLE 1.9 TDI 2.0 BORA (1J2)	
VW-627	6Q0-609-721F	02-	FRENO TRASERO POLO	1642



VW-626	1H0-609-721	1993	FRENO TRASERO GOLF (CON RESORTE)	1560
--------	-------------	------	----------------------------------	------



VW-628	5Z0609721B	2007	C. FNO DE MANO SPORTVAN TRENDLINE 1.6L RSH 74 kW, 4 CIL	1583
--------	------------	------	---	------

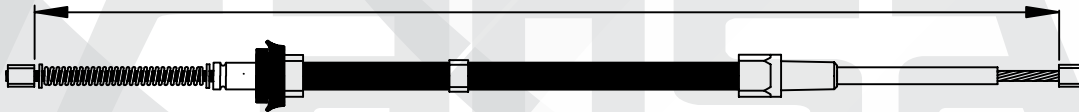

VW-629	1H0609721D		C. FNO DE MANO JETTA Y GOLF 93-98	1510
--------	------------	--	-----------------------------------	------



# Control de Temperatura /Temperature Control

NUMERO DE PARTE PART NUMBER	NUMERO DE CLIENTE CUSTOMER NUMBER	AÑO /YEAR	VEHICULO /VEHICLE	LONG. A
VW-607	11171171A	65-72	CONTROL DE TEMPERATURA VW SEDAN TIPO I	1425
VW-608	133711717	73-74	CONTROL DE TEMPERATURA VW SEDAN TIPO 732I CON VENTILADOR DE AIRE	1365

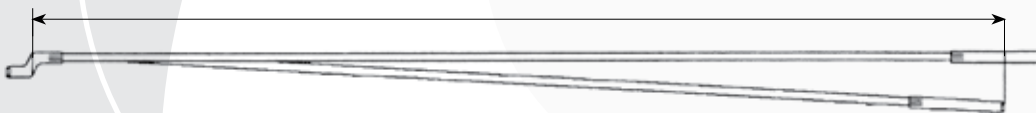

Importante: La información indicada en esta publicación, ha sido obtenida por fuentes confiables y oficiales, consideramos que es correcta, sin embargo no asumimos ninguna responsabilidad por errores, cambios, omisiones o daños que resulten de estos.

Freno de Mano y Control de Temperatura /Hand Brake and Temperature Control

NUMERO DE PARTE PART NUMBER	NUMERO DE CLIENTE CUSTOMER NUMBER	AÑO / YEAR	VEHICULO / VEHICLE	LONG. A
CH-700	55024942		LIBERADOR DE COFRE CAMIONETA PICK UP	2165

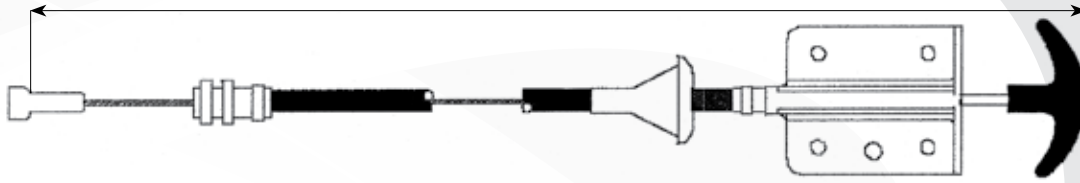

CH-701	55076109 55030118	93-00	LIBERADOR DE COFRE GRAN CHEROKEE MOTOR 8 CIL.	1877
--------	----------------------	-------	---	------

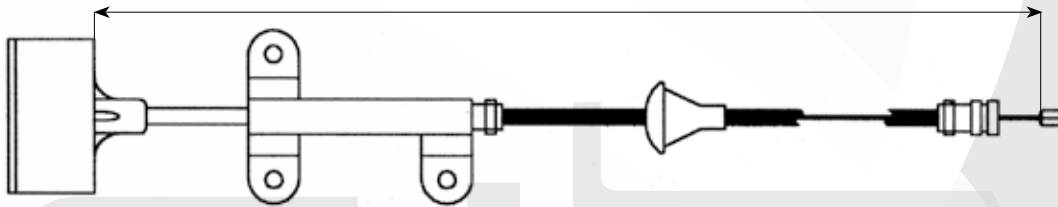

CH-702	04673097 0453401	93-00	LIBERADOR DE COFRE SK TODOS, VOYAGER 1993, VOYAGER SL I MADERA, SD VOYAGER 2-TONOD, SY VOYAGER TOWN & COUNTRY & SM VOYAGER SPORT	2000
--------	---------------------	-------	--	------



HY-700	8119002000	2000-	LIBERADOR DE COFRE HYUNDAI ATOS (05072079AA)	1395
--------	------------	-------	--	------

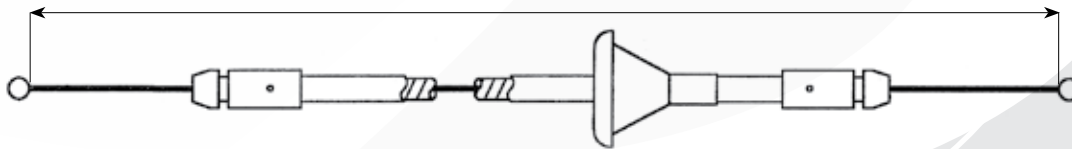

HY-701	8128006000	2000-	LIBERADOR DE CAJUELA HYUNDAI ATOS (05072084AA)	2677
--------	------------	-------	--	------

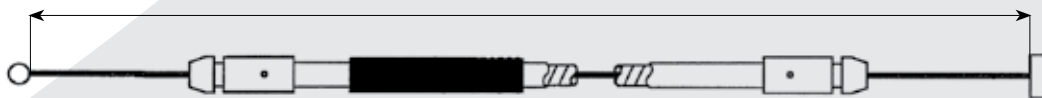

"Importante: La información indicada en esta publicación, ha sido obtenida por fuentes confiables y oficiales, consideramos que es correcta, sin embargo no asumimos ninguna responsabilidad por errores, cambios, omisiones o daños que resultaran de estos".

Tirantes de Cofre / Hood Cable



**GM DAEWOO**  
A General Motors Company

# Tirantes de Cofre / Hood Cable



NUMERO DE PARTE PART NUMBER	NUMERO DE CLIENTE CUSTOMER NUMBER	AÑO / YEAR	VEHICULO / VEHICLE	LONG. A
DW-700	96156491		TIRANTE DE COFRE DAEWOO	1650

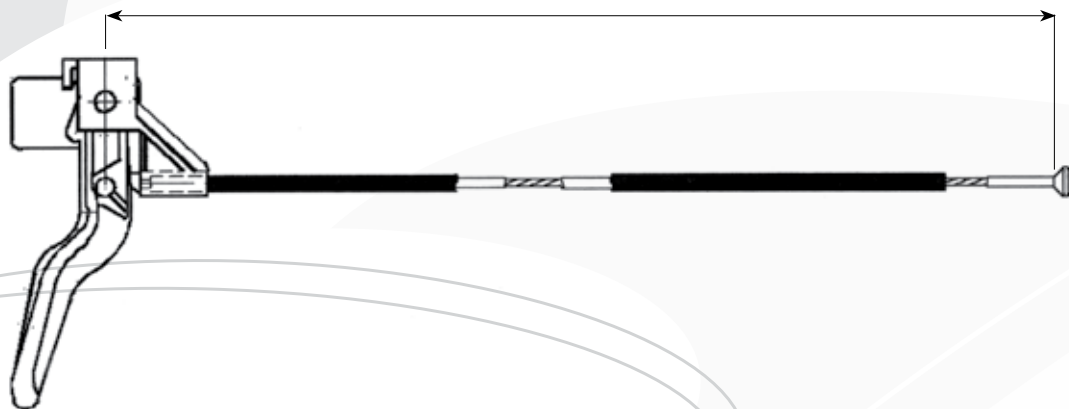

NUMERO DE PARTE PART NUMBER	NUMERO DE CLIENTE CUSTOMER NUMBER	AÑO / YEAR	VEHICULO / VEHICLE	LONG. A
DI-700			TIRANTE DE COFRE DINA LARGO	735
DI-701	A-21863		TIRANTE DE COFRE DI-600 4 CIL. CORTO	630



DI-702	2508040010		TANQUE AIRE DINA 09011 NAVISTAR	559
DI-703	2508040020		TANQUE AIRE DINA 09012 NAVISTAR	635
DI-704	2508040050		TANQUE AIRE DINA 09015 NAVISTAR	546
DI-705	2508040040		TANQUE AIRE DINA 09016 NAVISTAR	1120
DI-706	2508040060		TANQUE AIRE DINA 09018 NAVISTAR	790

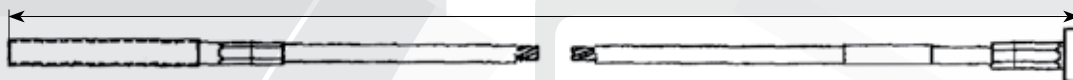

DI-707	250G010028		TRAMO DE RETEN PERNO DE ARRASTRE 09013 DINA NAVISTAR	711
--------	------------	--	--	-----

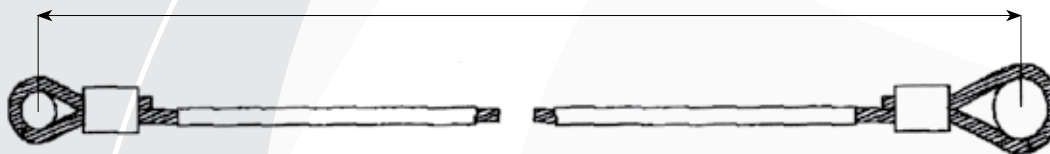

DI-708	764E09001A		COFRE DINA NAVISTAR (09014)	720
--------	------------	--	-----------------------------	-----



Importante: La información indicada en esta publicación, ha sido obtenida por fuentes confiables y oficiales, consideramos que es correcta, sin embargo no asumimos ninguna responsabilidad por errores, cambios, omisiones o daños que resulten de estos.

NUMERO DE PARTE PART NUMBER	NUMERO DE CLIENTE CUSTOMER NUMBER	AÑO / YEAR	VEHICULO / VEHICLE	LONG. A
DI-709	250A090010		CABLE PARA COFRE CLASE 6, 7 (09017)	200



DI-710	250A010060		CABLE ROSCADO COFRE (09034)	564
--------	------------	--	-----------------------------	-----

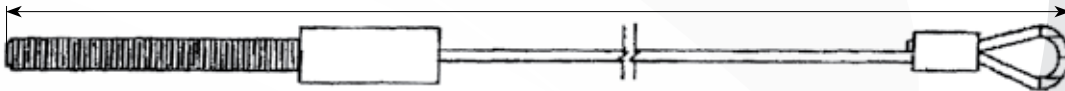

DI-711	250A010020	TODOS	CABLE TENSOR DE ACERO F-12	461
--------	------------	-------	----------------------------	-----

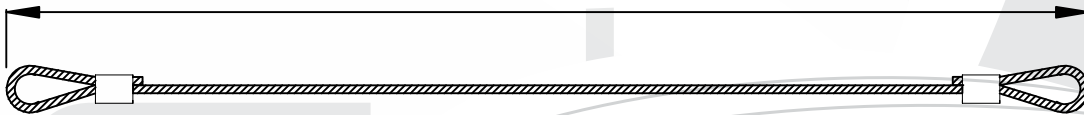

NUMERO DE PARTE PART NUMBER	NUMERO DE CLIENTE CUSTOMER NUMBER	AÑO / YEAR	VEHICULO / VEHICLE	LONG. A
FO-700		99-2001	LIBERADOR DE COFRE FIESTA	1881



FO-701		99-2001	LIBERADOR DE COFRE CONTOUR	1860
--------	--	---------	----------------------------	------



NUMERO DE PARTE PART NUMBER	NUMERO DE CLIENTE CUSTOMER NUMBER	AÑO / YEAR	VEHICULO / VEHICLE	LONG. A
FT-700	4405267/4237700		COFRE 147-127 (BRASIL)	2135



\*Importante: La información indicada en esta publicación, ha sido obtenida por fuentes confiables y oficiales, consideramos que es correcta, sin embargo no asumimos ninguna responsabilidad por errores, cambios, omisiones o daños que resultaran de estos\*.

Tirantes de Cofre / Hood Cable



# Tirantes de Cofre / Hood Cable



NUMERO DE PARTE PART NUMBER	NUMERO DE CLIENTE CUSTOMER NUMBER	AÑO / YEAR	VEHICULO / VEHICLE	LONG. A
FT-701	7663094		COFRE TEMPRA TT	1895

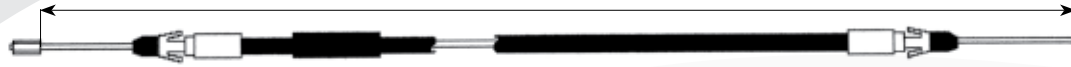

FT-702	43401268/4352898	87-90	COFRE 131 TT	1895
FT-703	5973151	88	COFRE UNO CS/DUNA/FIORINO	1900

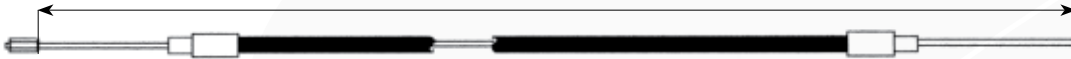

FT-704	6081317		COFRE UNO/PREMIO/ELBA/FIORINO	1597
--------	---------	--	-------------------------------	------

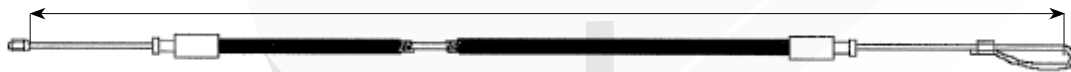

FT-705	4237700		COFRE 147/SPAZZIO/OGGI	825
--------	---------	--	------------------------	-----



NUMERO DE PARTE PART NUMBER	NUMERO DE CLIENTE CUSTOMER NUMBER	AÑO / YEAR	VEHICULO / VEHICLE	LONG. A
GM-700	15728525	97	COFRE SUBURBAN	2143



GM-701	90482081	90-	COFRE CHEVY & CHEVY MONZA	1482
--------	----------	-----	---------------------------	------

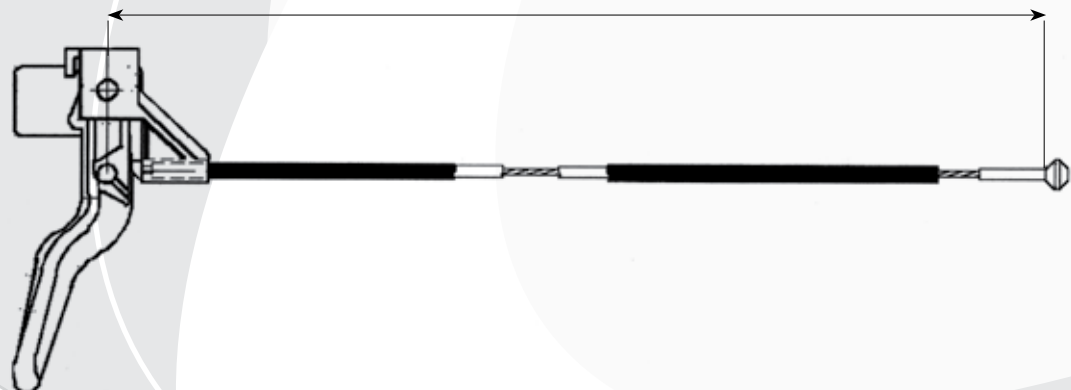

Importante: La información indicada en esta publicación, ha sido obtenida por fuentes confiables y oficiales, consideramos que es correcta, sin embargo no asumimos ninguna responsabilidad por errores, cambios, omisiones o daños que resulten de estos.

Tirantes de Cofre / Hood Cable

NUMERO DE PARTE PART NUMBER	NUMERO DE CLIENTE CUSTOMER NUMBER	AÑO / YEAR	VEHICULO / VEHICLE	LONG. A
GM-702		2002-2007	C. LIBERADOR COFRE CORSA 1.8L	1705

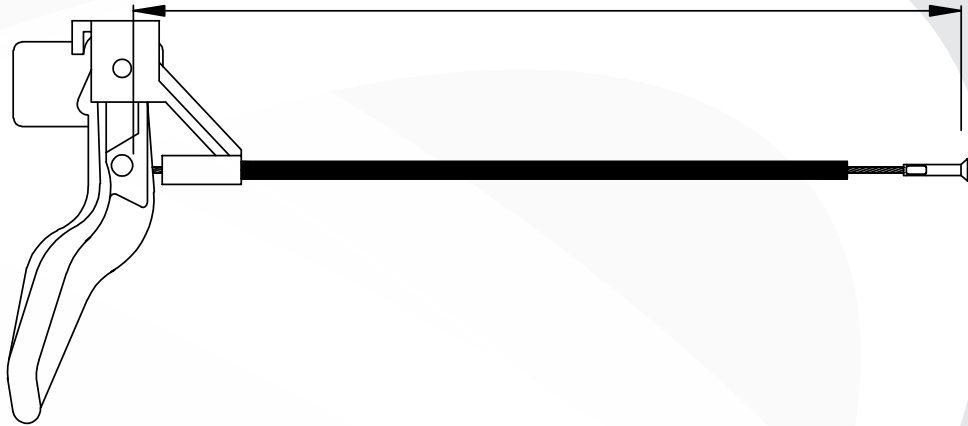

GM-703	22584242	90-94	C. LIBERADOR COFRE CAVALIER	2007
--------	----------	-------	-----------------------------	------

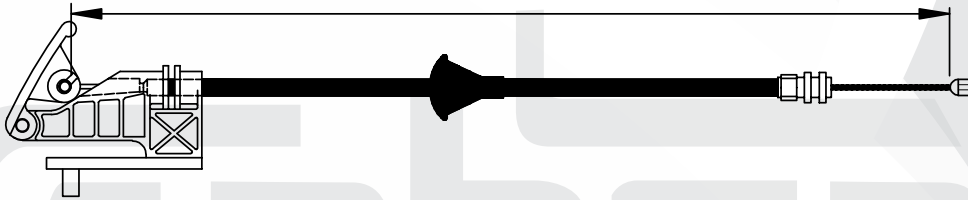

GM-704	22652156	96-03	C. LIBERADOR COFRE CAVALIER L4	1814
--------	----------	-------	--------------------------------	------

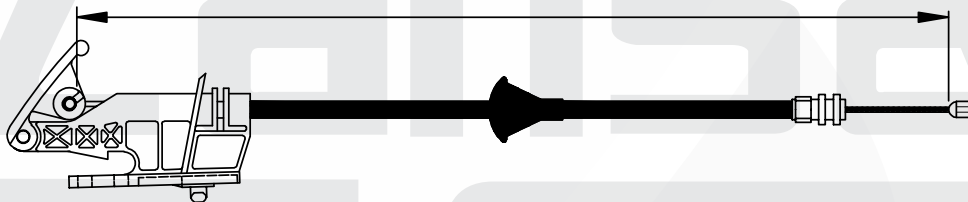

GM-705	15627455	91-94	CABLE LIBERADOR COFRE BLAZER	1844
--------	----------	-------	------------------------------	------



GM-706		1996	C. LIBERADOR COFRE S10 4-6 CIL	1844
--------	--	------	--------------------------------	------

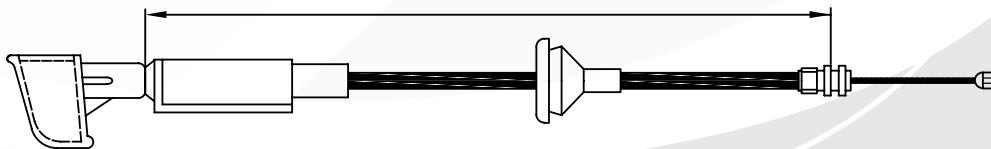

GM-707		2011-	C. LIBERADOR COFRE SPARK 1.2 L	1844
--------	--	-------	--------------------------------	------

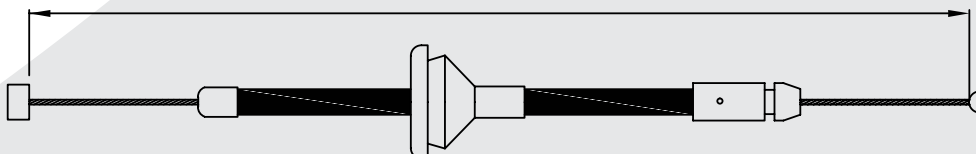

\*Importante: La información indicada en esta publicación, ha sido obtenida por fuentes confiables y oficiales, consideramos que es correcta, sin embargo no asumimos ninguna responsabilidad por errores, cambios, omisiones o daños que resultaran de estos\*.

Tirantes de Cofre / Hood Cable

NUMERO DE PARTE PART NUMBER	NUMERO DE CLIENTE CUSTOMER NUMBER	AÑO / YEAR	VEHICULO / VEHICLE	LONG. A
HY-700	8119002000	2000-	LIBERADOR DE COFRE HYUNDAI ATOS (05072079AA)	1395

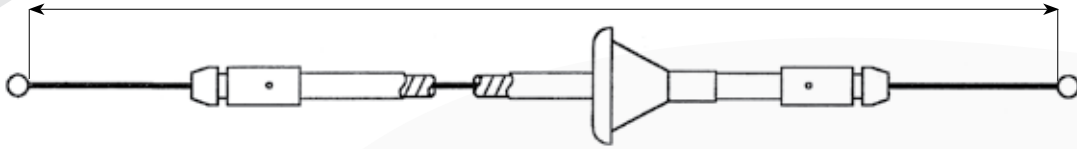

HY-701	8128006000	2000-	LIBERADOR DE CAJUELA HYUNDAI ATOS (05072084AA)	2677
--------	------------	-------	--	------

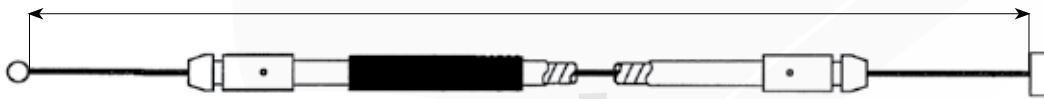

## NAVISTAR®

NUMERO DE PARTE PART NUMBER	NUMERO DE CLIENTE CUSTOMER NUMBER	AÑO / YEAR	VEHICULO / VEHICLE	LONG. A
NV-700	500827C1		SUJETADOR CAPOT NAVISTAR	545

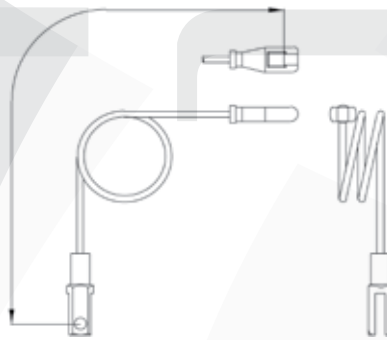

NV-701	1677457C1		SUJETADOR CAPOT NAVISTAR	1358
--------	-----------	--	--------------------------	------



Importante: La información indicada en esta publicación, ha sido obtenida por fuentes confiables y oficiales, consideramos que es correcta, sin embargo no asumimos ninguna responsabilidad por errores, cambios, omisiones o daños que resulten de estos.

NUMERO DE PARTE PART NUMBER	NUMERO DE CLIENTE CUSTOMER NUMBER	AÑO / YEAR	VEHICULO / VEHICLE	LONG. A
NI-700	65620-F4200	94-08	C. LIBERADOR DE COFRE TSURU III	1765
NI-701	65620-F4010	94-08	C. LIBERADOR DE COFRE PICK UP	1740



NUMERO DE PARTE PART NUMBER	NUMERO DE CLIENTE CUSTOMER NUMBER	AÑO / YEAR	VEHICULO / VEHICLE	LONG. A
PG-700	7937F2		LIBERADOR DE COFRE PEUGEOT 206	1775

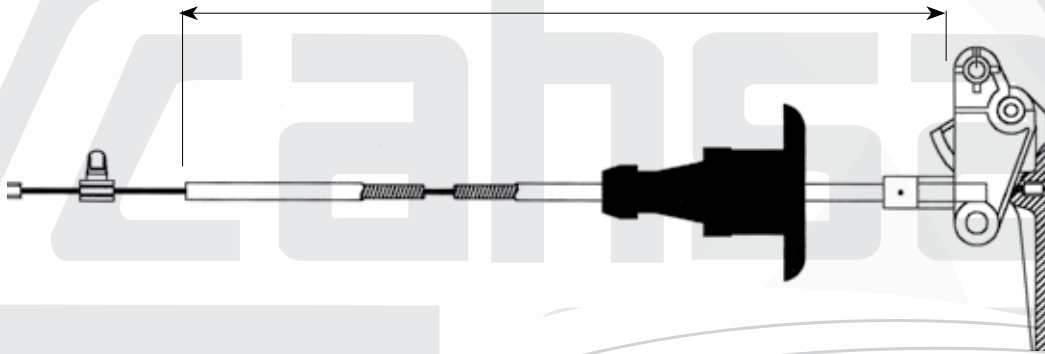

NUMERO DE PARTE PART NUMBER	NUMERO DE CLIENTE CUSTOMER NUMBER	AÑO / YEAR	VEHICULO / VEHICLE	LONG. A
TY-700		05-	CABLE LIBERADOR DE COFRE RAV4 4 CIL 2.4L	1793



"Importante: La información indicada en esta publicación, ha sido obtenida por fuentes confiables y oficiales, consideramos que es correcta, sin embargo no asumimos ninguna responsabilidad por errores, cambios, omisiones o daños que resultaran de estos".

Tirantes de Cofre / Hood Cable



# Tirantes de Cofre /Hood Cable



NUMERO DE PARTE PART NUMBER	NUMERO DE CLIENTE CUSTOMER NUMBER	AÑO /YEAR	VEHICULO /VEHICLE	LONG. A
VW-700	171823531G		COFRE SEDAN 1500/1600	2085



VW-701	171823531		COFRE CARIBE	1715
VW-703	321823531D		COFRE CORSAR	2115
VW-709	377823531A	98-2000	COFRE POINTER 2000	1760
VW-711	5Z0823531B		C. LIB. DE COFRE SPORTVAN TRENDLINE 1.6L RSH DE 74 Kw-GASOLINA	1725

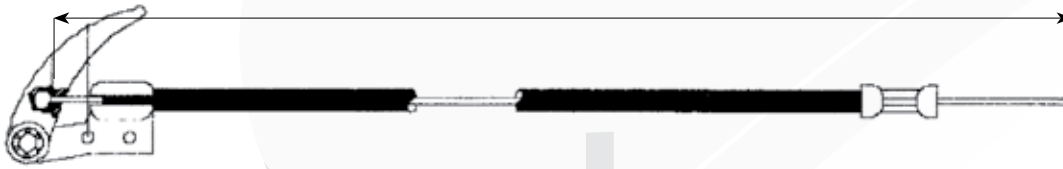

VW-702	8935002733		JUEGO DE TIRANTES DE ASIENTO CORTO	580
VW-704	192823531	-94	JUEGO DE TIRANTES DE ASIENTO GOLF	694



VW-705	192823531	88-92	TIRANTE DE COFRE GOLF JETTA	1725
VW-706	1H1823531	-93	TIRANTE DE COFRE GOLF JETTA DERBY (1HM823531)	1795
VW-707	191823531	9/83-87	TIRANTE DE COFRE GOLF IIª SERIE	1730



VW-708		93	TIRANTE DE ASIENTO VW SEDAN (LARGO)	724
--------	--	----	-------------------------------------	-----



Importante: La información indicada en esta publicación, ha sido obtenida por fuentes confiables y oficiales, consideramos que es correcta, sin embargo no asumimos ninguna responsabilidad por errores, cambios, omisiones o daños que resulten de estos.

Tirantes de Cofre /Hood Cable

NUMERO DE PARTE PART NUMBER	NUMERO DE CLIENTE CUSTOMER NUMBER	AÑO / YEAR	VEHICULO / VEHICLE	LONG. A
VW-710	321823531A		C. LIBERADOR DE COFRE PASSAT	1457



## Ahogadores y Paro de Motor / Choke Cables



NUMERO DE PARTE PART NUMBER	NUMERO DE CLIENTE CUSTOMER NUMBER	AÑO / YEAR	VEHICULO / VEHICLE	LONG. A
NI-920	18410-B65201	79-84	AHOGADOR PICK UP	1010
NI-921	18410-W-581-C	79-84	AHOGADOR DATSUN SEDAN	795
NI-924		-88	AHOGADOR UNIVERSAL	1530

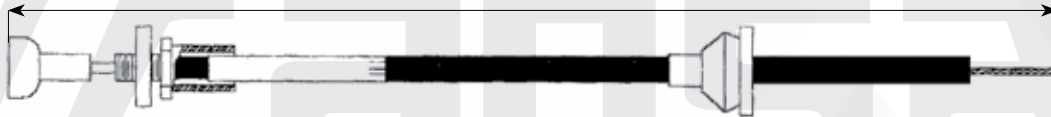

NI-922	18410-W-64R0	-88	AHOGADOR PICK UP	1230
NI-923			AHOGADOR TSURU ESPECIAL	1720

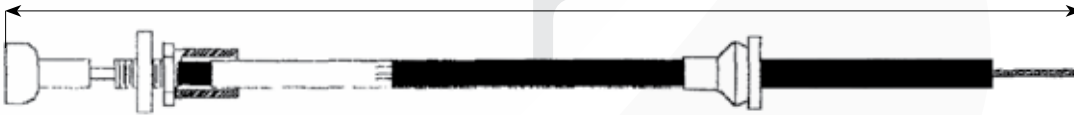

NI-925	18411A47R5	-88	AHOGADOR SAMURAI TSURU I NINJA	1570
--------	------------	-----	--------------------------------	------

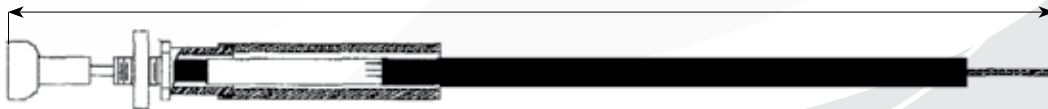

NI-926	18410P05G0	88-92	AHOGADOR TSURU I TURBO PICK UP	1560
--------	------------	-------	--------------------------------	------

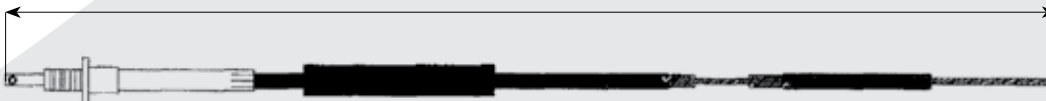

\*Importante: La información indicada en esta publicación, ha sido obtenida por fuentes confiables y oficiales, consideramos que es correcta, sin embargo no asumimos ninguna responsabilidad por errores, cambios, omisiones o daños que resultaran de estos.



# Ahogadores y Paro de Motor / Choke Cables



NUMERO DE PARTE PART NUMBER	NUMERO DE CLIENTE CUSTOMER NUMBER	AÑO / YEAR	VEHICULO / VEHICLE	LONG. A
NI-927	18411P03G0	88-92	AHOGADOR PICK UP	940
NI-928	18411A47R0	82-86	AHOGADOR SAMURAI TSURU I Y II VAGONETA, NINJA	1345



NUMERO DE PARTE PART NUMBER	NUMERO DE CLIENTE CUSTOMER NUMBER	AÑO / YEAR	VEHICULO / VEHICLE	LONG. A
RE-920			REPUESTO AHOGADOR	1470

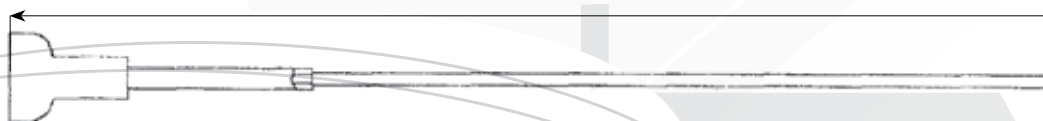

NUMERO DE PARTE PART NUMBER	NUMERO DE CLIENTE CUSTOMER NUMBER	AÑO / YEAR	VEHICULO / VEHICLE	LONG. A
SC-900	13634B		C. PARO DE MOTOR - SCANIA CAMINHAO L140/LK140/L141/LK141 COMPLETO SC2415	3340

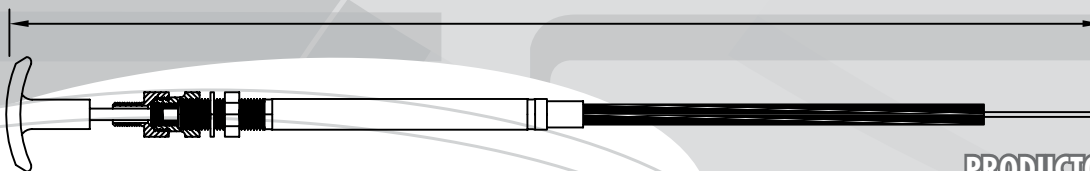

PRODUCTO NUEVO

## UNIVERSALES

NUMERO DE PARTE PART NUMBER	NUMERO DE CLIENTE CUSTOMER NUMBER	AÑO / YEAR	VEHICULO / VEHICLE	LONG. A
UN-202			AHOGADOR UNIVERSAL	2085



Importante: La información indicada en esta publicación, ha sido obtenida por fuentes confiables y oficiales, consideramos que es correcta, sin embargo no asumimos ninguna responsabilidad por errores, cambios, omisiones o daños que resulten de estos.

Ahogadores y Paro de Motor / Choke Cables

NUMERO DE PARTE PART NUMBER	NUMERO DE CLIENTE CUSTOMER NUMBER	AÑO /YEAR	VEHICULO /VEHICLE	LONG. A
VR-900	2362127		PARO DE MOTOR 1.50 MTS.	1905
VR-901	236217-HD		PARO DE MOTOR 2.00 MTS.	2380
VR-902			CABLE CONTROL DE VELOCIDADES CAMIONES KENWORTH	4380

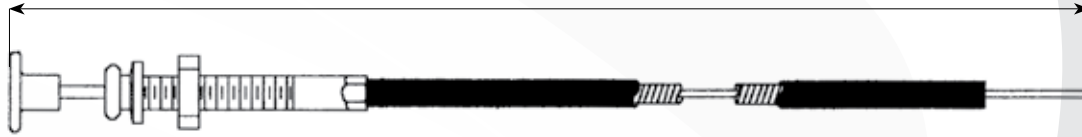

VR-903			CONTROL DE VELOCIDADES KENWORTH	2280
--------	--	--	---------------------------------	------

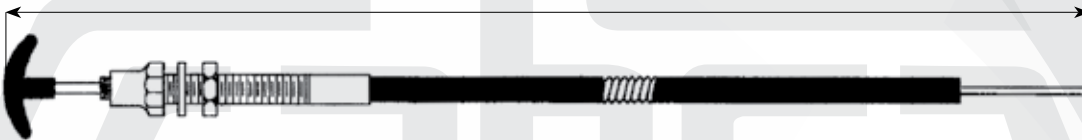



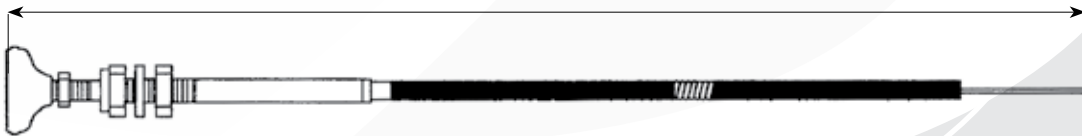



VR-904			CONTROL DE VELOCIDADES II TT, TOMA DE FUERZA 9FT.	3210
VR-905			CONTROL DE VELOCIDADES II TT, TOMA DE FUERZA 18FT.	6000
VR-906			CONTROL DE VELOCIDADES II TT, TOMA DE FUERZA 12FT.	3300
VR-907			CONTROL DE VELOCIDADES II TT, TOMA DE FUERZA 15FT.	4860
VR-908			CONTROL DE VELOCIDADES II TT, TOMA DE FUERZA 21FT.	6684



"Importante: La información indicada en esta publicación, ha sido obtenida por fuentes confiables y oficiales, consideramos que es correcta, sin embargo no asumimos ninguna responsabilidad por errores, cambios, omisiones o daños que resultaran de estos".

## Cables Selector de Velocidades /Transhift Cables

	<b>CHRYSLER</b>	<b>PAG129-134</b>
	<b>FORD</b>	<b>PAG 135-136</b>
	<b>GENERAL MOTORS</b>	<b>PAG 136-145</b>
	<b>HYUNDAI</b>	<b>PAG 145-146</b>
	<b>HONDA</b>	<b>PAG 146</b>
	<b>KIA MOTORS</b>	<b>PAG 146</b>
<b>NAVISTAR®</b>	<b>NAVISTAR</b>	<b>PAG 146</b>
	<b>NISSAN</b>	<b>PAG 147-148</b>
	<b>PEUGEOT</b>	<b>PAG 148</b>
	<b>TOYOTA</b>	<b>PAG 148</b>
	<b>VOLKSWAGEN</b>	<b>PAG 149-150</b>

®

## Con terminal del conduit Acanalada (G) o Roscada (T)

Código

Ejemplo del No. de parte:

173-MTG-2-90

### Construcción

- 173 - Con pernos de acero inoxidable
- 174 - Con pernos, tubos de soporte y cable interno de acero inoxidable
- 183 - Con superficies de nylon y teflón y pernos de acero inoxidable
- 184 - Con superficies de nylon y teflón, pernos y tubos de soporte de acero inoxidable y cubierta de teflón en el cable interno

### Capacidad de carga

Disponibles en: V (very light duty), L (light duty), M (medium duty), H (heavy duty), Se determina por la carga o por el  $\phi$  del perno, ver la tabla A mostrada abajo

### Terminales del conduit

TT (ambas terminales roscadas), GG (ambas terminales acanaladas), TG (una terminal roscada y otra acanalada), ver tabla A y diagrama B abajo para las dimensiones

### Longitud de viaje

De 1 a 6 pulgadas, determinelo de la tabla A y el diagrama C de abajo

### Longitud total (en pulgadas)

Longitud total (en pulgadas)

## Capacidades de carga y longitud de viaje

Tabla A

Todos los cables					Terminales del conduit roscadas						Terminales del conduit acanaladas												
Número de parte básico	Cuerda "F"	Radio min en pulgs	Capacidad de carga de jalón en libras todos los viajes	Capacidad de carga de empuje para viajes mostrados en libras					Cuerda "W"	Dimensión "A" para los viajes mostrados en pulgadas													
				1"	2"	3"	4"	5"		6"	Dimensión del acanalado		Dimensión "A" para los viajes mostrados en pulgadas										
				1"	2"	3"	4"	5"	6"	1"	2"	3"	4"	5"	6"	Radio pulgs	Diam. pulgs	1"	2"	3"	4"	5"	6"
V	10-32 X 0.89"	2	120	80	70	60	45	30	7/16"-20h X 1.12"	4.38"	5.87"	7.38"	8.87"	10.38"	11.87"	.13 ancho	.25	3.69"	5.19"	6.69"	8.19"	9.69"	11.13"
L	1/4"-28h X 1.00"	3	230	150	125	100	75	50	5/8"-18h X 1.50"	4.62"	6.12"	7.62"	9.12"	10.62"	12.12"	.17	.41	4.00"	5.50"	7.00"	8.50"	10.00"	11.50"
M	5/16"-24h X 1.19"	5	400	250	210	170	130	100	11/16"-16h X 1.75"	5.06"	6.56"	8.06"	9.56"	11.06"	12.56"	.17	.47	4.33"	5.87"	7.38"	8.87"	10.38"	11.87"
H	3/8"-24h X 1.38"	6	1,000	700	600	500	400	300	7/8"-14h X 2.00"	5.69"	7.19"	8.69"	10.19"	11.69"	13.19"	.20	.50	5.19"	6.69"	8.19"	9.69"	11.19"	12.69"

Conversiones mm: 1 pulg = 25.4 mm. V = M 5 X .8 L = M 6 X 1.0 M = M 8 X 1.25 H = 10 X 1.5

## Terminales del conduit

### Tipo T

Terminal roscada para montaje de mamparo

### Tipo G

Terminal acanalada para montaje con frenos en U o agarres

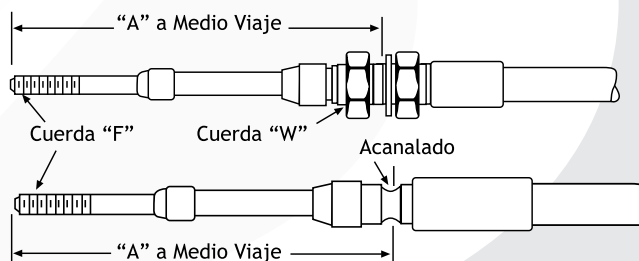

## Longitud total y viaje en pulgadas

### Para reemplazar un cable

- A. Quitar el viejo cable
- B. Medir la longitud como se muestra abajo en pulgadas
- C. Medir la longitud del viaje, de 1 a 6 pulgadas
- D. Determina el tamaño de la cuerda "F" selecciona el número de parte básico de la tabla anterior



### Para cables de nuevos

- A. Determina la longitud total
- B. Mide el viaje requerido, agrega 1/4" y entonces giralo hacia arriba para acercarlo a la pulgada siguiente
- C. Determina las cargas y selecciona el número de parte básico de la tabla A. Así como el método para ordenar un cable de control

# Método para ordenar cables de control con perilla

## Con cable interno flexible

Ordena la perilla de la carta de abajo

Diametro de Cuerda p/ perilla  
 Utilitario/Baja Fricción  
 VLD 1/4" - 28 UNF  
 LD 5/16" - 18 UNC  
 Comercial  
 VLD 1/4" - 20 UNC

Diametro del agujero para el montaje  
 Utilitario/Baja Fricción  
 VLD 7/16" diam.  
 LD 5/8" diam.  
 Comercial 3/8" diam.

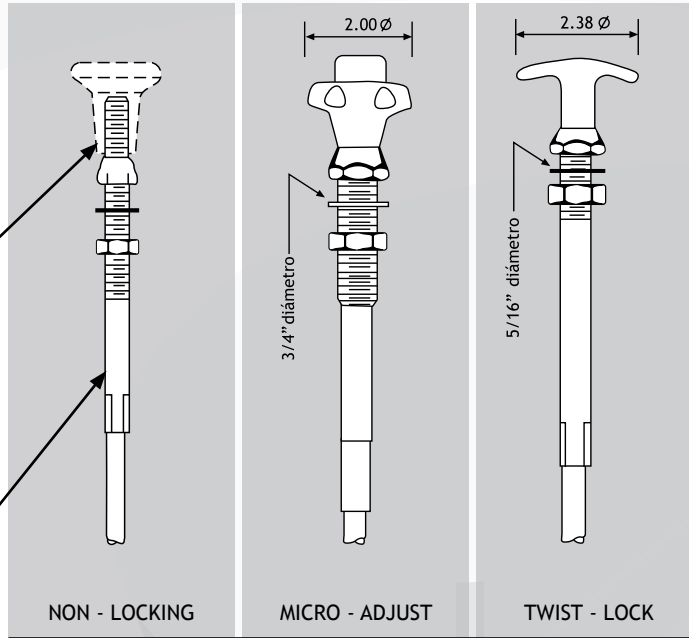

## Utilitario y baja fricción

1" 2" y 3" viaje  
 2" min. radio en VLD  
 3" min. radio en LD  
 60 lb. rango de carga

## Como Ordenar

1. Selecciona el número de parte básico
2. Indica el viaje conforme al ejem. de abajo
3. Indica la long. en pulgadas

## Ejemplo del Código

56V02 - 3 - 120  
 Longitud en pulgadas  
 1" 2" o 3" viaje  
 No. de parte básico (ejemplo en twist lock con terminal roscada)

V - very light duty (VLD)  
 L - light duty (LD)

## Opciones del extremo externo

	VLD	LD	VLD	LD	VLD	LD	
<b>Utilitario</b>	86V02	96L02	26V02	26L02	56V02	56L02	Terminal de conduit roscada 
<b>Baja fricción</b>	83V02	93L02	23V02	23L02	53V02	53L02	
<b>Utilitario</b>	86V03	96L03	26V03	26L03	56V03	56L03	Terminal de conduit acanalada 
<b>Baja fricción</b>	83V03	93L03	23V03	23L03	53V03	53L03	

	NON - LOCKING		MICRO - ADJUST		TWIST - LOCK		
	VLD	LD	VLD	LD	VLD	LD	Terminal twist-on
<b>Comercial</b>							
Cables de control con perilla con alambre de acero inoxidable hasta 3" de viaje 5" min. radio 20 lb. rango de carga de jalón	79V00		29V00		59V00		
	79V04		29V04		59V04		
	79V05		29V05		59V05		

## Perillas opcionales para controles non-locking

	Utilitario VLD	Baja fricción LD	Comercial
Longitud de cuerdas	1/4 - 28 UNF	5/16 - 18 UNC	1/4 - 20 UNC
1" redondo	165-172-308	SIN	165-172-306
2.4" Tipo - T	165-172-014	165-172-013	165-172-005
2" Hongo	165-103-001	165-103-006	165-103-002
2" Toma de fuerza (PTO)	165-183-001	165-183-003	165-183-002

## Friction Lock

Para ordenar, agrega el sufijo "F" a los No. de parte de micro ajuste. por ejemplo: 26V02F indicará un friction lock con un cable utilitario y una terminal roscada (debe agregarse previo al ensamble)

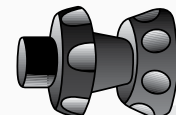

NUMERO DE PARTE PART NUMBER	NUMERO DE CLIENTE CUSTOMER NUMBER	AÑO / YEAR	VEHICULO / VEHICLE	LONG. A
CH800	4369592	84-86	C. TRANSVERSAL DE VEL DART K, VOLARE TRANS STD	1035
CH801	4369591	84-86	C. SELECTOR DE VEL DART K, VOLARE TRANS STD	920
CH808		84-90	C. SELECTOR DE VEL MAGNUM TRANS STD	1212
CH810	4377303	86-88	C. SELECTOR DE VEL DART K, VOLARE TRANS STD (LARGO)	1065
CH811	4412669	84-90	C. TRANSVERSAL DE VEL DART K, VOLARE TRANS STD (LARGO)	1195
CH814	4446878	85-89	C. TRANSVERSAL SHADOW, CARAVAN TRANS STD	1110
CH816		TODOS	C. SELECTOR DE VEL MAGNUM TURBO Y VOYAGER TRANS STD	1269
CH817	4435619	1986	C. TRANSVERSAL SHADOW, CARAVAN, MAGNUM 5 VEL TRANS STD	1015
CH819		1984	C. TRANSVERSAL DODGE DAYTONA 4 CIL 2.2L TRANS STD	1207
CH820	4431268	1986	C. TRANSVERSAL DE VEL MAGNUM TRANS STD	1205
CH821		1987	C. SELECTOR PHANTOM TURBO 6 CIL TRANS STD	1287
CH822	4317321	86-88	C.SELECTOR DART Y VOLARE K TRANS STD	1230
CH823	4377303	86-88	C.SELECTOR DART Y VOLARE K EUROPA TRANS STD	1260

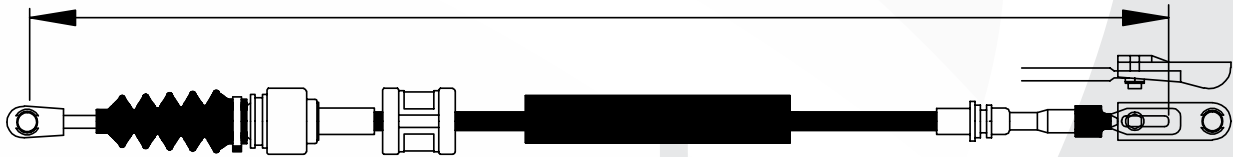

CH802	4269896	82-88	C.SELECTOR DART K DODGE DART CURVO 2.2L TRANS AUT	1080
CH834		82-86	C. SELECTOR DODGE CAMIONETA DART K TRANS AUT	1143

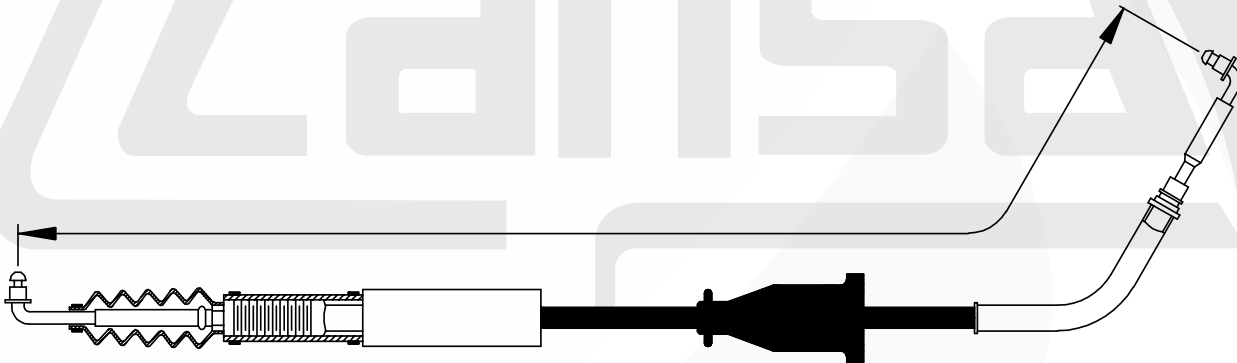

CH804	4412652	89-91	C. SELECTOR SPIRIT SHADOW Y LEBARON 2.5L, 2.2L, TURBO V6	1425
	4412653	86-90	3.0L, ARIES RELIANT, LEBARON, TOWN COUNTRY, 600 TRANS AUTOMATICA AL PISO EXCEPTO CONVERTIBLE	
	4377303	87-90	TRANS SHADOW SUNDANCE C/ TRANS AL PISO ARIES, SPIRIT C/ TRANSMISION AL PISO	
CH826	4377302	1988	C. SELECTOR PHANTOM, TRANSMISION AUT AL PISO	1505
CH827		1982	C. SELECTOR DODGE DART K TRANSMISION AUT AL PISO	985

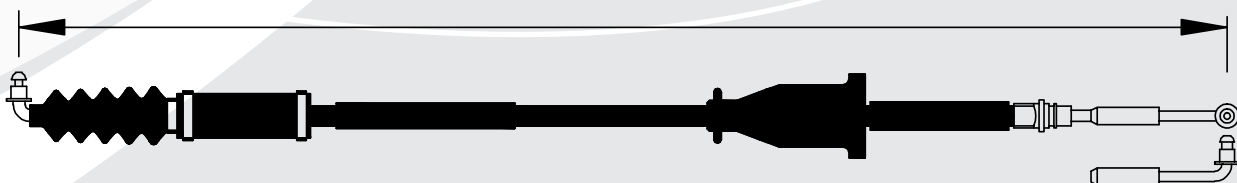

"Importante: La información indicada en esta publicación, ha sido obtenida por fuentes confiables y oficiales, consideramos que es correcta, sin embargo no asumimos ninguna responsabilidad por errores, cambios, omisiones o daños que resultaran de estos".

NUMERO DE PARTE PART NUMBER	NUMERO DE CLIENTE CUSTOMER NUMBER	AÑO / YEAR	VEHICULO / VEHICLE	LONG. A
CH805	4377317	82-90	C. SELECTOR DE VELOCIDADES DODGE CODIGO K TRANS AUT	755

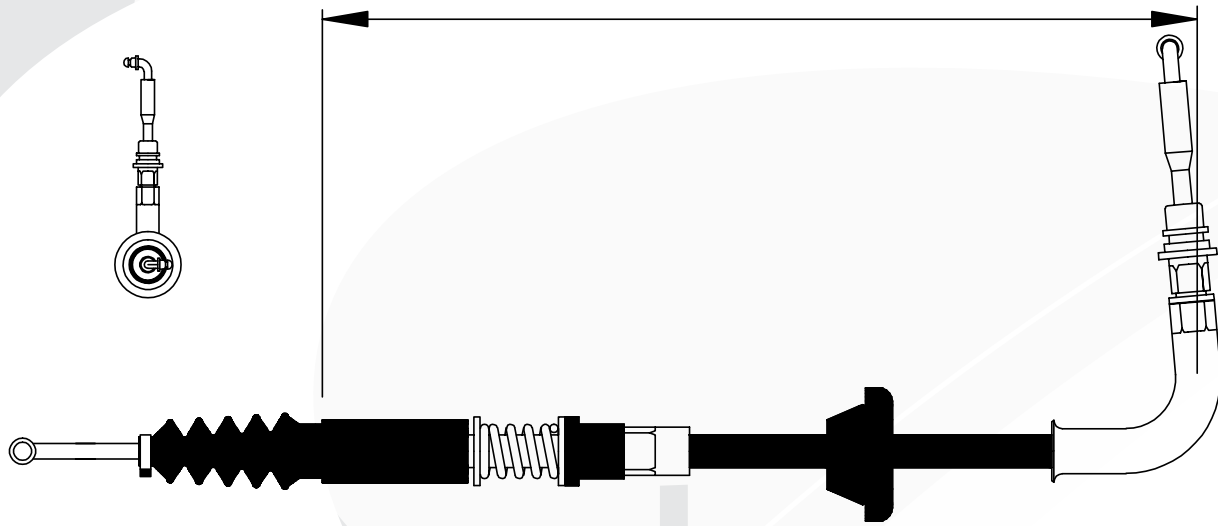

CH806	04670135 0464101	93-00	C. SELECTOR DE VELOCIDADES SK TODOS, VOYAGER 1993, SL VOYAGER 1-MADERA, VOYAGER 2-TONOD, SY VOYAGER TOWN COUNTRY & SM SPORT, TRANSMISION AUTOMATICA	735
-------	---------------------	-------	---	-----

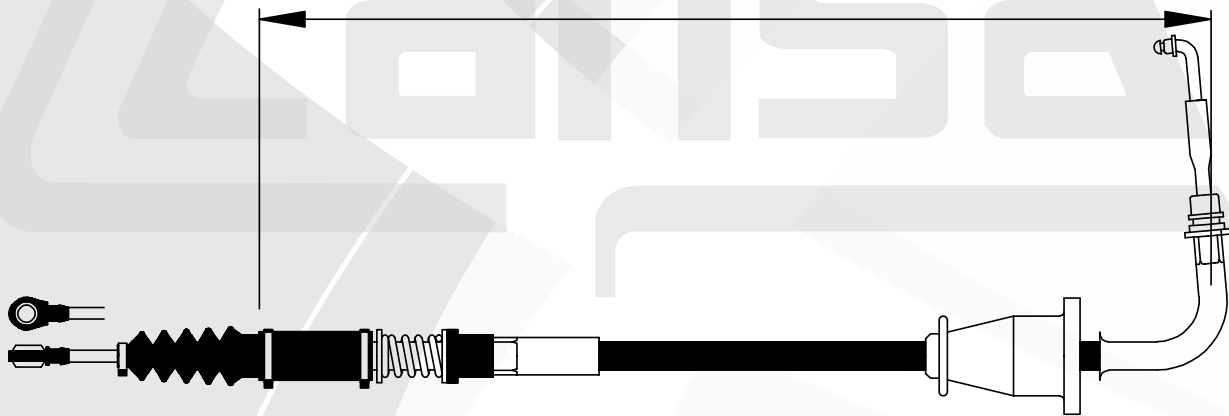

CH807	47650019	93-00	C. SELECTOR DE VEL STRATUS TRANS AUTOMATICA MEX	1426
CH830	4593781	1994	C. SELECTOR INTREPID CONCORDE STD MEX	1840

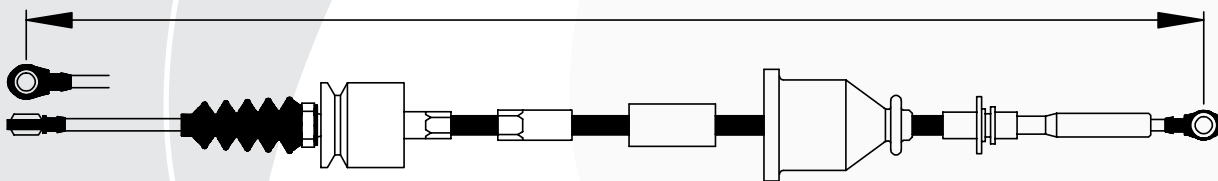

\*Importante: La información indicada en esta publicación, ha sido obtenida por fuentes confiables y oficiales, consideramos que es correcta, sin embargo no asumimos ninguna responsabilidad por errores, cambios, omisiones o daños que resulten de estos.\*

Cables Selector de Velocidades / Transhift Cables

NUMERO DE PARTE PART NUMBER	NUMERO DE CLIENTE CUSTOMER NUMBER	AÑO / YEAR	VEHICULO / VEHICLE	LONG. A
CH809	4543042	90-94	C. SELECTOR SPIRIT TRANS AUT AL PISO NACIONAL	1429
	4641011	90-94	SHADOW, SPIRIT Y LEBARON (CON OJILLO) TRANS AUT. MEX	
CH832	4641010	92-93	C. SELECTOR PHANTOM TURBO, TRANS AUT AL PISO	1505

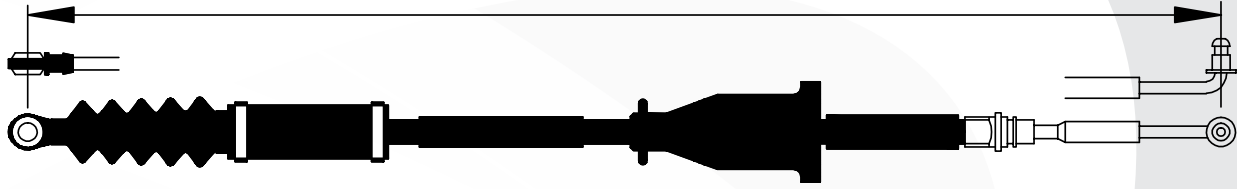

CH812	4446854	85-89	C. SELECTOR DE VEL. SHADOW, CARAVAN (USA) TRANS STD	1295
CH813		85-89	C. SELECTOR DE VELOCIDADES SHADOW, CARAVAN	1300
CH828		1987	C. SELECTOR DE VEL. PHANTOM TURBO 6 CIL 2.8L STD	1345
CH829	4377320		C. SELECTOR DE VELOCIDADES CARAVAN TRANS STD	1280

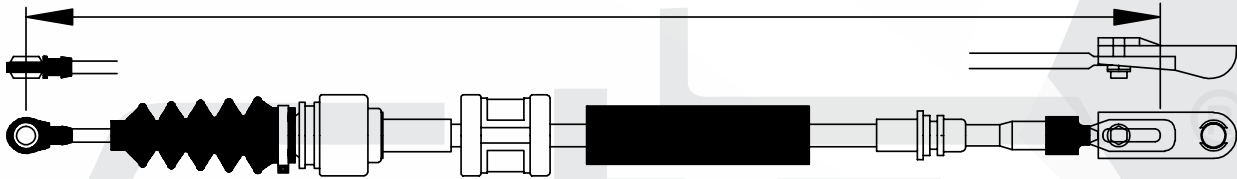

CH815	4641435	95-00	C. SELECTOR DE VEL. NEON TRANSMISION STD	1223
CH824	4593381	95-00	C. SELECTOR DE VELOCIDADES STRATUS TRANSMISION STD	1235



CH818	4543046	1991	C. SEL DE VEL SPIRIT, SHADOW, LEBARON, VOYAGER U.S.A. T. AUT	750
-------	---------	------	--	-----

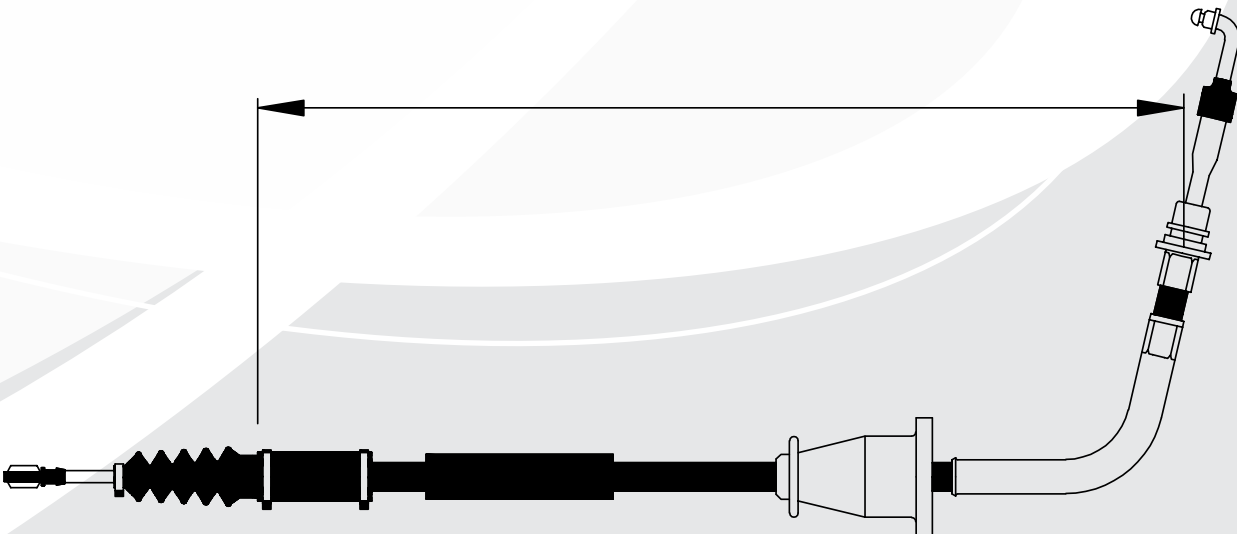

"Importante: La información indicada en esta publicación, ha sido obtenida por fuentes confiables y oficiales, consideramos que es correcta, sin embargo no asumimos ninguna responsabilidad por errores, cambios, omisiones o daños que resultaran de estos".

NUMERO DE PARTE PART NUMBER	NUMERO DE CLIENTE CUSTOMER NUMBER	AÑO / YEAR	VEHICULO / VEHICLE	LONG. A
CH825	4504342	90-94	C. SELECTOR SHADOW TRANS STD AMERICANO DOBLE OJILLO	1320
CH831	4504341	1995	C. SELECTOR NEON TRANS STD AMERICANO DOBLE OJILLO	1310

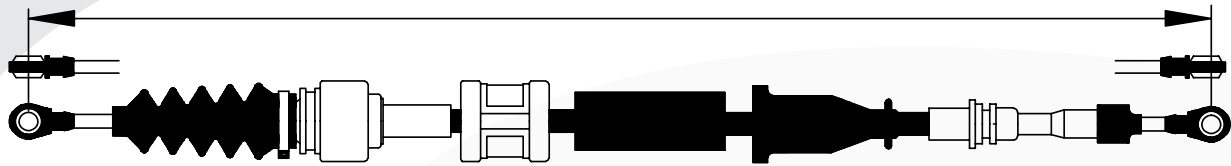

CH833	4593782	97-99	C. SELECTOR DE VEL CONCORDE	1508
-------	---------	-------	-----------------------------	------



CH835	8953004-561	1992	C. SEL GRAND CHEROKEE LAREDO, TRANSMISION AUT (USA)	2300
CH836	210T4H	1998	C. SEL DODGE RAM VAN TRANSMISION AUTOMATICA	1990
CH837	52107676	1998	C. SELECTOR DE VEL DODGE RAM VAN TRANS AUTOMATICA	1875
CH838	52104095	1995	C. SEL GRAND CHEROKEE TRANSMISION AUTOMATICA	1092

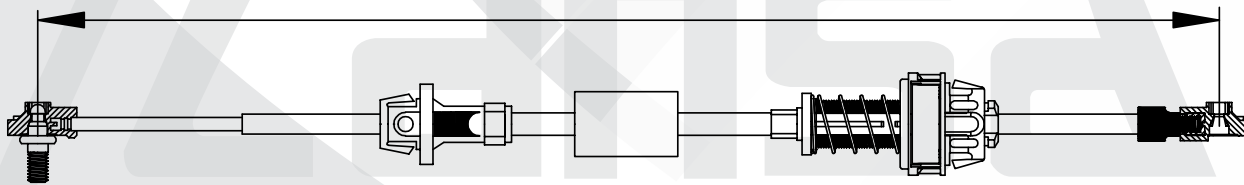

CH840	52104060AC	2000	C. SELECTOR GRAND CHEROKEE (PLASTICO) TRANS AUT	1169
CH841	52107700	94-98	C. SEL PICK UP DAKOTA 6C PALANCA AL VOLANTE T. AUT. (USA)	1524

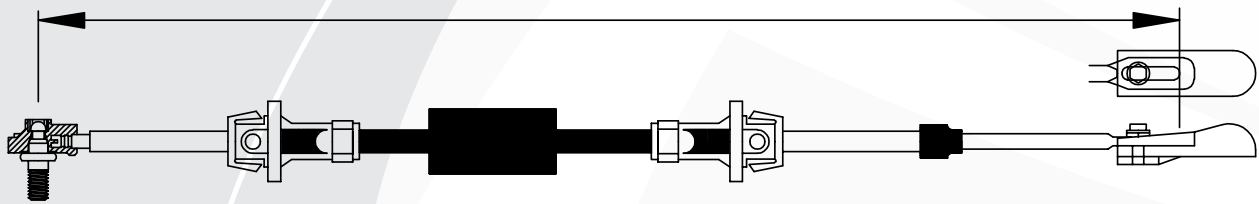

CH842		2000	C. SELECTOR GRAND CHEROKEE, DOBLE TRACCION TRANS AUT	1505
CH843	098T4E		C. SELECTOR GRAND CHEROKEE 4x4, DOBLE TRACCION TRANS AUT	905
CH844		1997	C. SELECTOR DE VELOCIDADES EAGLE TALON 4CIL TRANS STD	1310

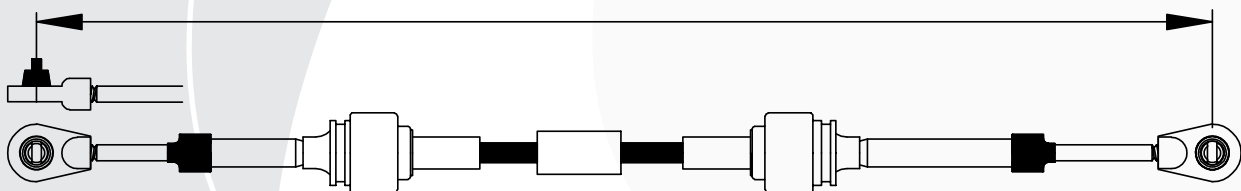

\*Importante: La informacion indicada en esta publicacion, ha sido obtenida por fuentes confiables y oficiales, consideramos que es correcto, sin embargo no asumimos ninguna responsabilidad por errores, cambios, omisiones o daños que resulten de estos.\*

Cables Selector de Velocidades / Transhift Cables

NUMERO DE PARTE PART NUMBER	NUMERO DE CLIENTE CUSTOMER NUMBER	AÑO / YEAR	VEHICULO / VEHICLE	LONG. A
CH845	8354	1997	C. TRANSVERSAL DE VEL EAGLE TALON 4 CIL TRANS STD	1407

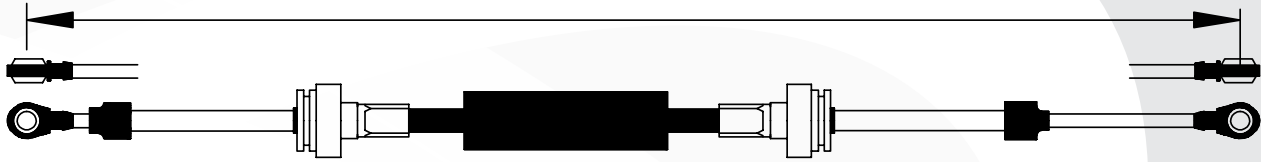

CH846	4446854	88-90	C. TRANSVERSAL DE VEL PHANTOM TRANS STD	1150
CH848		88-90	C. SELECTOR DE VEL PHANTOM TRANS STD	1295
CH849	4641135	95-00	C. SELECTOR DE VEL NEON TRANS STD	1220
CH861	4593381	95-00	C. TRANSVERSAL DE VEL STRATUS TRANS STD	1245

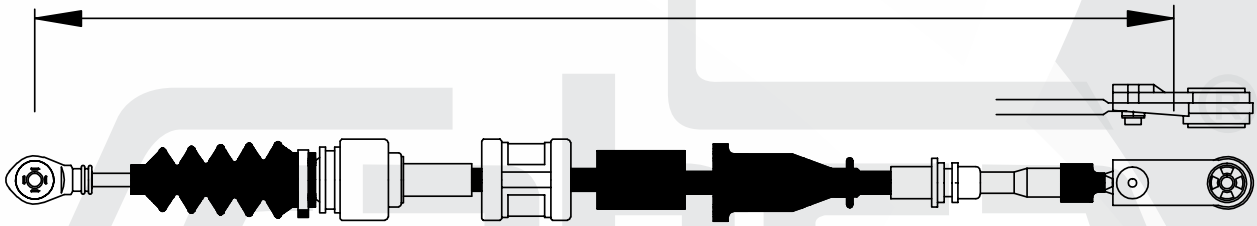

CH847		1990	C. SELECTOR DE VEL SHADOW TRANS STD	1295
-------	--	------	-------------------------------------	------

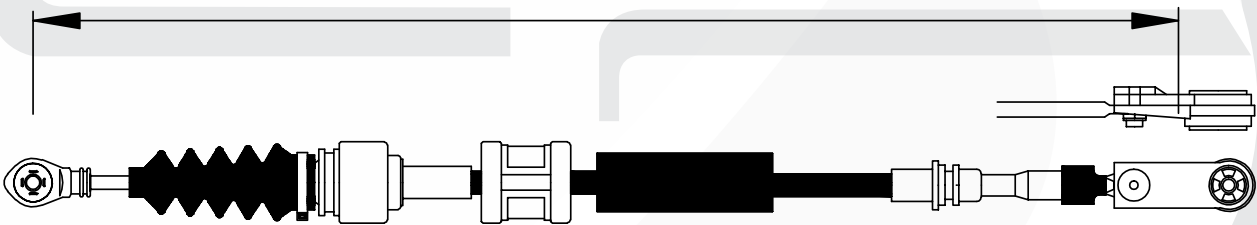

CH862			C. SELECTOR DE VEL PLYMOUTH VOYAGER TRANS AUT	1125
-------	--	--	---	------

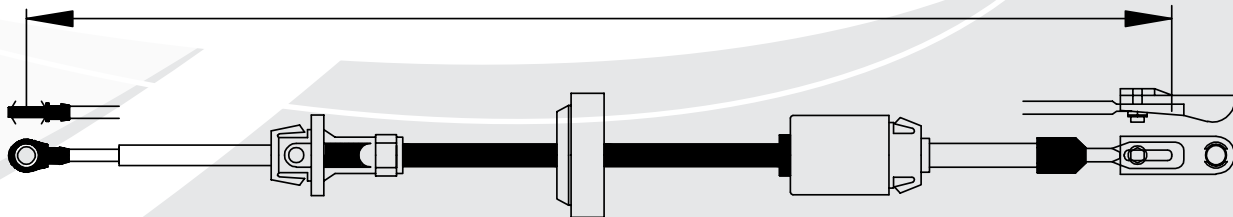

"Importante: La información indicada en esta publicación, ha sido obtenida por fuentes confiables y oficiales, consideramos que es correcta, sin embargo no asumimos ninguna responsabilidad por errores, cambios, omisiones o daños que resultaran de estos".

NUMERO DE PARTE PART NUMBER	NUMERO DE CLIENTE CUSTOMER NUMBER	AÑO / YEAR	VEHICULO / VEHICLE	LONG. A
CH850	4369592	84-86	C. TRANS DE VEL REFORZADO DART K, VOLARE TRANS STD	1035
CH851	4369591	84-86	C. SEL DE VEL REFORZADO DART K, VOLARE TRANS STD	920

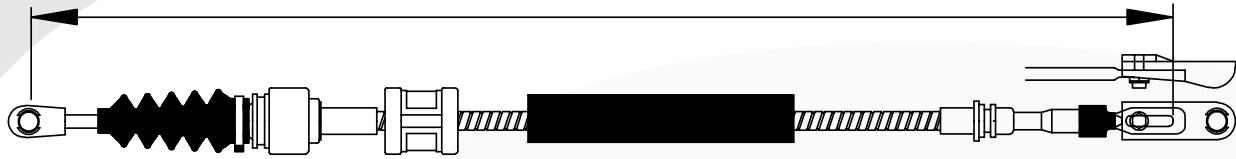

CH852	4269896	1982	C. SECTOR REF DART K DODGE DART CURVO 2.2L TRANS AUT	1080
-------	---------	------	--	------

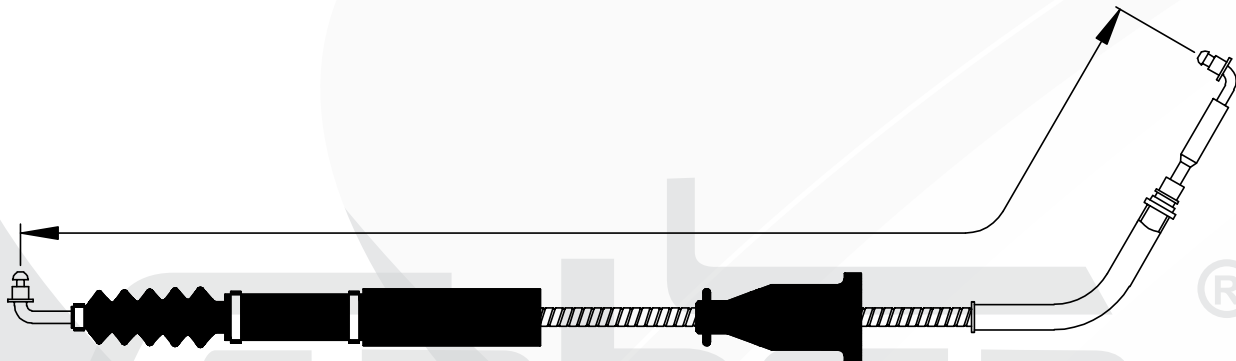

CH854	4412652	89-91	C. SECTOR SPIRIT, SHADOW Y LEBARON 2.5L, 2.2L TURBO V6	1425
	4412653	86-90	3.0L, ARIES RELIANT, LEBARON, TOWN COUNTRY 600 TRANS AUTOMATICA AL PISO EXCEPTO CONVERTIBLE	
	4377303	87-90	TRANS SHADOW, SUNDANCE C/TRANS AL PISO ARIES, SPIRIT C/ TRANSMISION AL PISO	

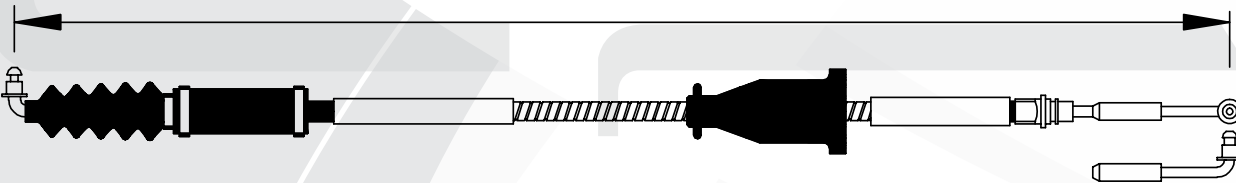

CH856	04670135	93-00	C. SECTOR DE VELOCIDADES SK TODOS, VOYAGER 1993, SL	735
	0464101		VOYAGER 1-MADERA, VOYAGER 2-TONOD, SY VOYAGER TOWN COUNTRY & SM SPORT, TRANSMISION AUTOMATICA	

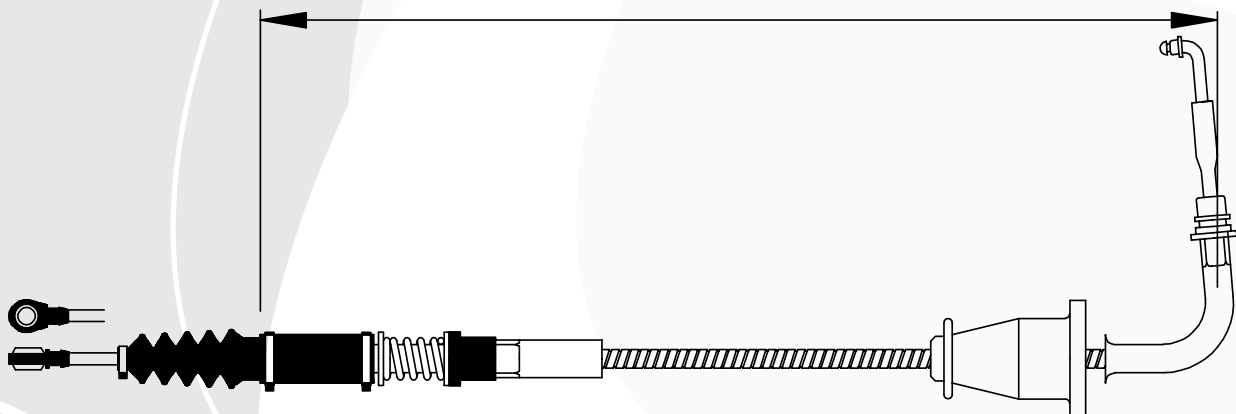

\*Importante: La informacion indicada en esta publicacion, ha sido obtenida por fuentes confiables y oficiales, consideramos que es correcta, sin embargo no asumimos ninguna responsabilidad por errores, cambios, omisiones o daños que resulten de estos.

Cables Selector de Velocidades / Transhift Cables

NUMERO DE PARTE PART NUMBER	NUMERO DE CLIENTE CUSTOMER NUMBER	AÑO / YEAR	VEHICULO / VEHICLE	LONG. A
F0800		84-87	C. SELECTOR DE VELOCIDADES (FUNDA DELGADA) TOPAZ	1073
F0802	843Y-7E395-ZANF	TODOS	C. SELECTOR DE VELOCIDADES TOPAZ	1090
F0803	H843Y-7E395-BA	TODOS	C. TRANSVERSAL DE VELOCIDADES TOPAZ	1070

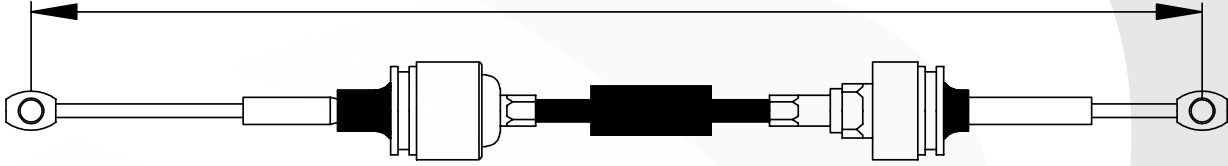

F0804	Y54Z-7E395-BA	2000	JUEGO SELECTOR DE VEL FOCUS TRANSMISION AUT	1590 1770
-------	---------------	------	---	--------------

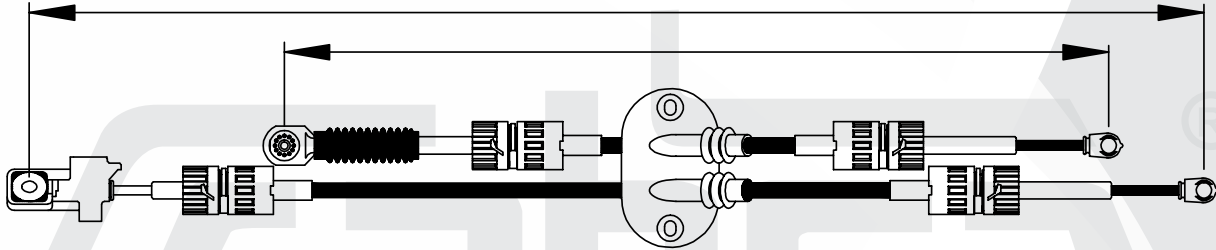

F0805	F292-7E395-B	TODOS	C. SELECTOR DE VELOCIDADES AEROSTAR TRANS AUT	740
F0806		TODOS	C. SEL DE VEL AEROSTAR PALANCA AL PISO TRANS AUT (USA)	693



F0810		90-96	C. SELECTOR DE VEL TAURUS (USA)	970
-------	--	-------	---------------------------------	-----

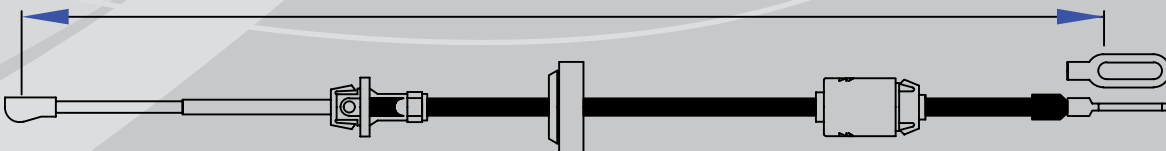

**PRODUCTO NUEVO**

"Importante: La información indicada en esta publicación, ha sido obtenida por fuentes confiables y oficiales, consideramos que es correcta, sin embargo no asumimos ninguna responsabilidad por errores, cambios, omisiones o daños que resultaran de estos".



# Cables Selector de Velocidades / Transhift Cables



NUMERO DE PARTE PART NUMBER	NUMERO DE CLIENTE CUSTOMER NUMBER	AÑO / YEAR	VEHICULO / VEHICLE	LONG. A
F0811	F27A-7E395-JD	95-96	SEL. DE VEL. PICK UP F150 (6 CIL), F250 (8 CIL)	1385
	F2TA-7F395-JD		TRANSMISION AUTOMATICA (AMERICANO)	
F0812	F29A-7E395-EF	93	SEL. DE VEL. AEROSTAR TRANS AUT (USA)	1595
F0813	F5UA-7E459-AA	94	SEL. DE VEL. WINDSTAR Y ECONOLINE TRANS AUT.	1855
F0814	F3TA-7E395-EA	93-96	SEL. DE VEL. FORD PICK UP F250 TRANSMISION AUTOMÁTICA (AMERICANO Y NACIONAL)	1495
F0815	X	92	SEL. DE VEL. ECONOLINE TRANS AUT (USA)	1755
F0816	X	2004	SEL. DE VEL. FORD PICK UP LOBO F250 MOTOR TRITON TRANSMISION AUTOMATICA (MEXICO)	1215
F0817	F77A-7E395-MD	TODOS	SEL. DE VEL. FORD EXPLORER TRANS AUT (USA)	1245
F0818	X	TODOS	SEL. DE VEL. FORD EXPLORER TRANS STD (MEX)	1355
F0819	PMF67A-7E395-HA	97	SEL. DE VEL. FORD EXPLORER Y RANGER TRANSMISION AUTOMÁTICA (AMERICANO)	1295



PRODUCTO NUEVO



NUMERO DE PARTE PART NUMBER	NUMERO DE CLIENTE CUSTOMER NUMBER	AÑO / YEAR	VEHICULO / VEHICLE	LONG. A
GM800	14080703	84-87	C. SELECTOR DE VELOCIDADES CITATION	1295
GM805	14080701	TODOS	C. SELECTOR DE VELOCIDADES CITATION	1337
GM808		82-86	C. TRANSVERSAL DE VELOCIDADES CELEBRITY	1530
GM809			C. SELECTOR DE VELOCIDADES CAVALIER (USA) TRANS STD	1250
GM826	14080704	82-86	C. TRANSVERSAL DE VEL CELEBRITY TRANS STD	1530
GM827		1982	C. SELECTOR DE VELOCIDADES CITATION TRANS STD	1105

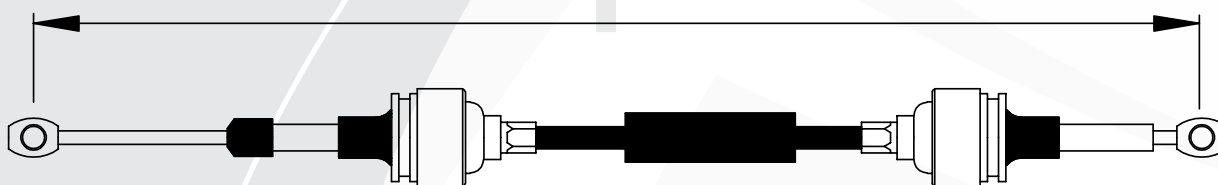

GM801	25537476	84-88	C. SEL TRANSMISION CUTLASS C/CONSOLA & SEL DE RANGO	652
-------	----------	-------	---	-----



"Importante: La información indicada en esta publicación, ha sido obtenida por fuentes confiables y oficiales, consideramos que es correcta, sin embargo no asumimos ninguna responsabilidad por errores, cambios, omisiones o daños que resulten de estos."

NUMERO DE PARTE PART NUMBER	NUMERO DE CLIENTE CUSTOMER NUMBER	AÑO /YEAR	VEHICULO /VEHICLE	LONG. A
GM802	25537476	1993	C. SELECTOR DE VELOCIDADES CAVALIER	1246
	14093397	1986	C. SELECTOR DE VELOCIDADES CAVALIER AMERICANO 4CIL	



GM803	10022405	82-94	C. SELECTOR TRANS SKYHAWK, MALIBU 82-83, CADILLAC CIMARRON/CADET C/SEL DE RANGO 1983, SKYLARK 2.5L C/SEL DE VEL 1985, CAVALIER/CADET W/SELECTOR DE RANGO & CODE 1985-1986, SKYLARK MOTOR 2.5L 1986-1991 CAVALIER/CADET MOTOR 2.2G C/SECTOR DE RANGO 1991 CAVALIER/CADET MOTOR 2.2-4 Y 2.0H C/SEL DE RANGO 92-94	1265
-------	----------	-------	---	------

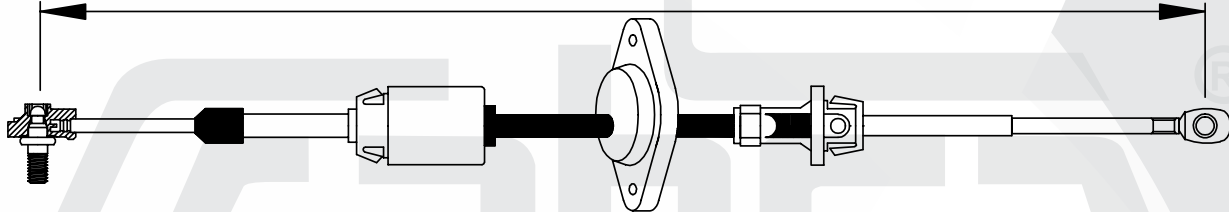

GM804	10037686	84-85	C. CENTURY, CELEBRITY, CIERA, 6000 C/SECTOR DE RANGO EXC. CONSOLE, SKYLARK, CITATION, 6000 W/RANGER SELECT & CRUISE EXC. CONSOLE 2.8-W	1477
GM844			C. SECTOR CELEBRITY TRANS STD	1300
GM845	10041214		C. SEL CELEBRITY CITATION CENTURY CUTLASS TRANS AUT	1380
GM857	10203557		C. SECTOR TRANS AM, CAMARO, FIREBIRD (USA) T. AUT	725
GM858	343-T2H		C. SECTOR DE VEL CAVALIER (MEXICO)	1144

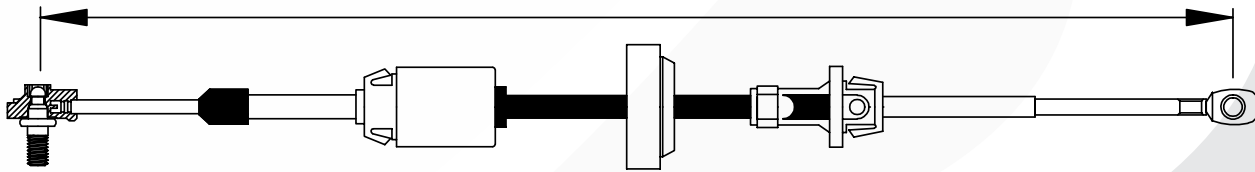

GM806	22539959	86-90	C. SECTOR DE VELOCIDADES CAVALIER (USA) 4CIL	1242
-------	----------	-------	--	------

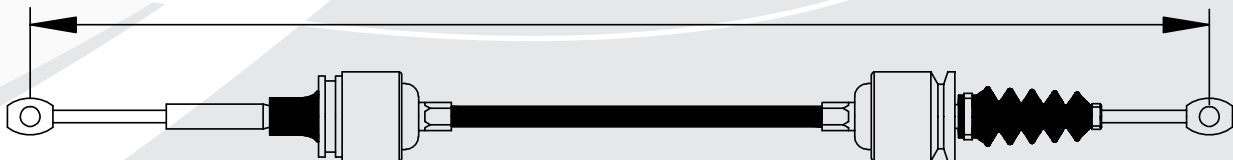

"Importante: La información indicada en esta publicación, ha sido obtenida por fuentes confiables y oficiales, consideramos que es correcta, sin embargo no asumimos ninguna responsabilidad por errores, cambios, omisiones o daños que resultaran de estos".

Cables Selector de Velocidades /Transhift Cables



# Cables Selector de Velocidades / Transhift Cables



NUMERO DE PARTE PART NUMBER	NUMERO DE CLIENTE CUSTOMER NUMBER	AÑO / YEAR	VEHICULO / VEHICLE	LONG. A
GM807	1408072	82-86	C. SECTOR DE VELOCIDADES CELEBRITY	1572
GM824		1981	C. SECTOR DE VELOCIDADES CELEBRITY STD	1350
GM825			C. SECTOR DE VELOCIDADES CELEBRITY (USA) TRANS AUT	1498

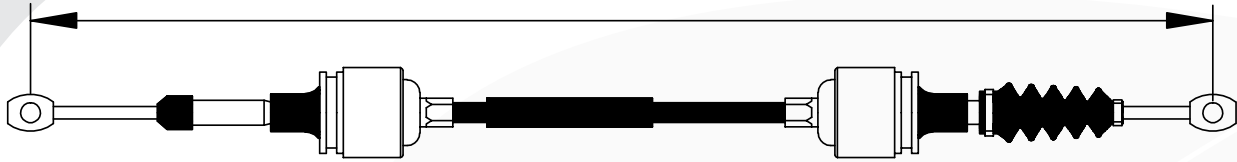

GM810	22578975	1993	C. SECTOR DE VELOCIDADES CAVALIER STD NACIONAL	1245
GM846	22571778	1993	C. SECTOR DE VELOCIDADES CAVALIER 4CIL	1235
GM847	22570006	1993	C. SECTOR DE VELOCIDADES PONTIAC GRAND AM 2.3L (USA)	1280
GM848	22576975	1994	C. TRANSVERSAL DE VELOCIDADES CAVALIER TRANS STD C.G.	1235
GM849	21120173	1995	C. TRANSVERSAL DE VEL SATURNO AMERICANO T. STD	1270



GM811	22535554	86-88	C. SECTOR DE VEL CAVALIER OJILLO CHICO Y GRANDE USA	1250
-------	----------	-------	---	------



GM812		1988	C. SECTOR DE VELOCIDADES CELEBRITY 3.1L	1470
GM815	22539955	1991	C. SEL DE VEL CAVALIER, GRAND AM, CUTLASS 2.4L 5V STD	1306
GM816	10186818	90-91	C. TRANSVERSAL DE VEL CAVALIER BERETTA	1250
GM819		1990	C. SECTOR DE VEL CAVALIER NACIONAL	1143
GM830	22539958	90-94	C. SECTOR DE VEL CAVALIER 6CIL TRANS STD	1266
GM834	10079792	1989	C. SECTOR DE VEL CELEBRITY OJILLO GRANDE 6 CIL	1475
GM836	22539955	1995	C. SECTOR DE VELOCIDADES CAVALIER 4CIL TRANS STD	1310



"Importante: La información indicada en esta publicación, ha sido obtenida por fuentes confiables y oficiales, consideramos que es correcta, sin embargo no asumimos ninguna responsabilidad por errores, cambios, omisiones o daños que resulten de estos."

NUMERO DE PARTE PART NUMBER	NUMERO DE CLIENTE CUSTOMER NUMBER	AÑO / YEAR	VEHICULO / VEHICLE	LONG. A
GM813	22539961	1991	C. SELECTOR DE VELOCIDADES PONTIAC GRAN AM USA	1220
GM814		1989	C. SELECTOR DE VELOCIDADES CELEBRITY 6CIL (MEXICO)	1505
GM837	22539965	1991	C. SELECTOR DE VELOCIDADES CAVALIER TRANS STD	1180

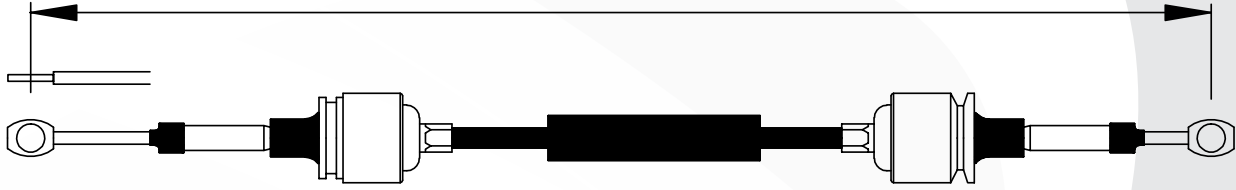

GM817		1991	C. SELECTOR DE VEL CUTLASS EUROSPORT 4 PTAS 6 CIL	1515
-------	--	------	---	------



GM818		1991	C. SELECTOR DE VEL CAVALIER CON CUENCAS (AMERICANO)	1135
GM822			C. TRANSVERSAL DE VELOCIDADES PONTIAC C/CUENCAS	1308
GM842	22535006	1988	C. TRANSVERSAL PONTIAC GRAND AM STD	1225
GM843	14101422	1987	C. TRANSVERSAL DE VEL CUTLASS EUROSPORT 4P 6C STD	1473



GM820		79-81	C. SELECTOR DE VEL MONTECARLO Y MALIBU, SUBURBAN	750
-------	--	-------	--	-----

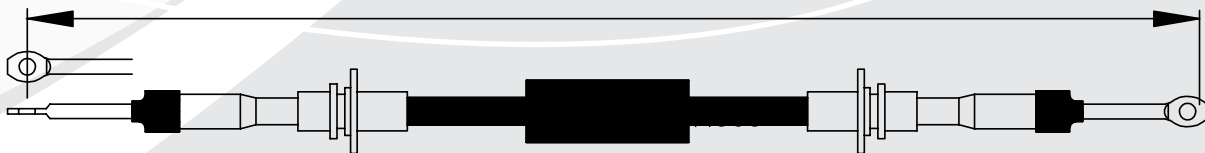

"Importante: La información indicada en esta publicación, ha sido obtenida por fuentes confiables y oficiales, consideramos que es correcta, sin embargo no asumimos ninguna responsabilidad por errores, cambios, omisiones o daños que resultaran de estos".



# Cables Selector de Velocidades / Transhift Cables



NUMERO DE PARTE PART NUMBER	NUMERO DE CLIENTE CUSTOMER NUMBER	AÑO / YEAR	VEHICULO / VEHICLE	LONG. A
GM821	14051052	TODOS	C. TRANSVERSAL DE VELOCIDADES PONTIAC 4CIL	1185
GM840	14072299	1984	C. SELECTOR DE VELOCIDADES BUICK SKYLARK Y PONTIAC	1230
GM841			C. SELECTOR DE VELCAVALIER CUENCAS GRANDES 6C T. STD	1240

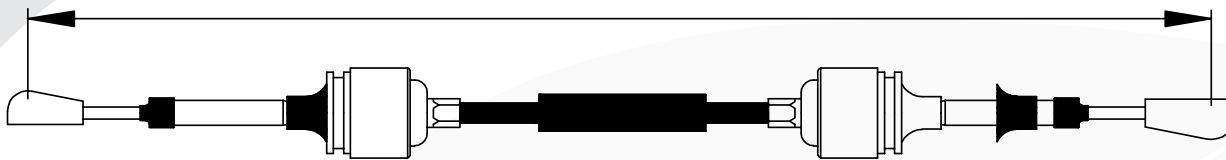

GM823	22650715	95-97	C. TRANSVERSAL DE VEL CAVALIER MOTOR 2.2L FUEL INJ	1460
-------	----------	-------	--	------

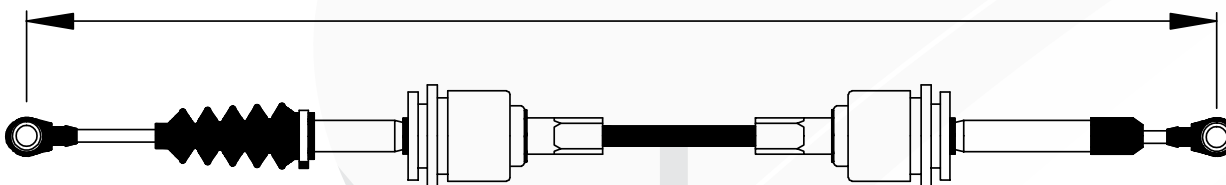

GM828	10079793	1989	C. TRANSVERSAL CELEBRITY 2.8L 6CIL STANDARD	1470
GM829		98-00	C. SEL DE VEL CAVALIER TRANSMISION STD	1245
GM831	10079793		C. TRANSVERSAL DE VEL CUTLASS EUROSPORT 4P 6C T STD	1470
GM832	22539964	90-94	C. SELECTOR DE VEL CAVALIER OJILLO GRANDE 6C T STD	1242
GM833		1989	C. SELECTOR DE VEL CELEBRITY OJILLO GRANDE 6C T STD	1503
GM835	225539964	1991	C. SELECTOR DE VEL CAVALIER OJILLO GRANDE 4C T STD	1245



GM838	22535006	1988	C. SELECTOR DE PONTIAC GRAND AM STANDARD	1240
GM839	14093376	1990	C. SELECTOR PONTIAC GRANADA 5 VEL 4CIL STD	1306

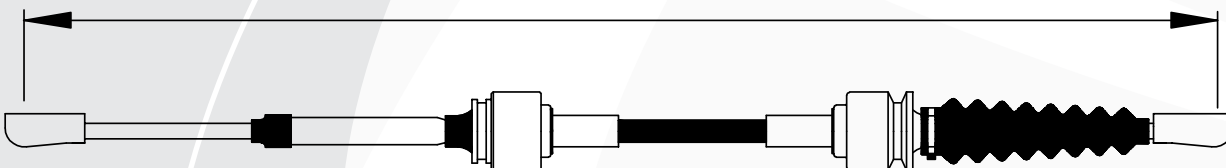

GM850		1981	C. SELECTOR DE VELOCIDADES MALIBU TRANS AUT	610
-------	--	------	---	-----

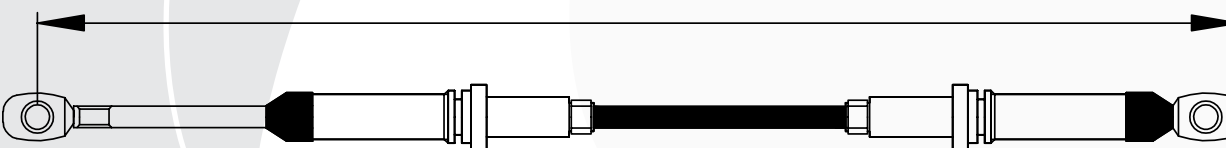

\*Importante: La informacion indicada en esta publicacion, ha sido obtenida por fuentes confiables y oficiales, consideramos que es correcta, sin embargo no asumimos ninguna responsabilidad por errores, cambios, omisiones o danos que resulten de estos.

NUMERO DE PARTE PART NUMBER	NUMERO DE CLIENTE CUSTOMER NUMBER	AÑO / YEAR	VEHICULO / VEHICLE	LONG. A
--------------------------------	--------------------------------------	------------	--------------------	---------

GM851	22535555	1995	C. SECTOR DE VELOCIDADES CAVALIER TRANS STD	1265
-------	----------	------	---	------

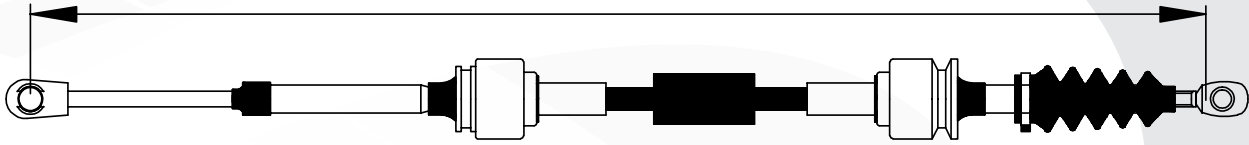

GM852			C. SECTOR DE VEL CAVALIER OJILLO-PALETA TRANS STD	1235
-------	--	--	---	------

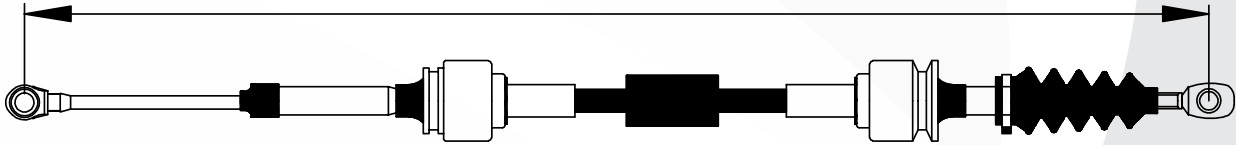

GM853			C. SECTOR DE VEL BERETTA AMERICANO TRANS STD	1284
GM854			C. SECTOR DE VEL BERETTA CUENCA Y OJILLO GRANDE T STD	1295
GM855	10066459	1986	C. SECTOR DE VEL CUTLASS EUROSPORT 4 PTAS 6CIL T STD	1480

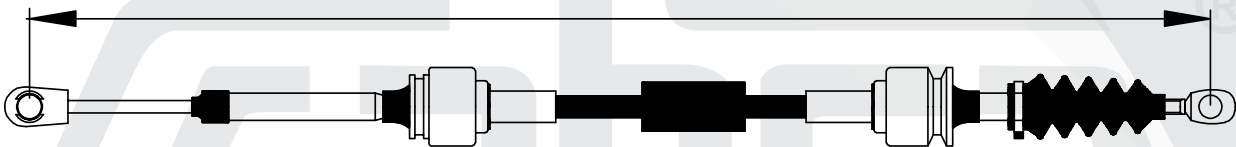

GM856	10027422		C. SEL DE VEL CELEBRITY, CITATION, CENTURY, CUTLASS, T AUT	1265
GM861		1986	C. SEL DE VEL CENTURY, TRANS AUT (MEXICO)	1380

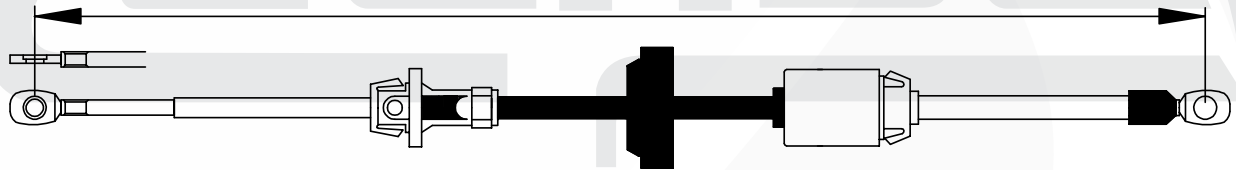

GM859		2001	C. SEL DE VEL CAVALIER FUEL INJECTION, TRANS STD	1515
-------	--	------	--	------

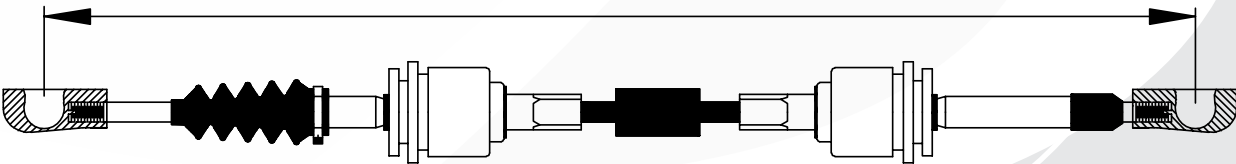

GM860	21120173	1995	C. SEL DE VELOCIDADES SATURN CUENCA Y OJILLO	1270
-------	----------	------	--	------



"Importante: La información indicada en esta publicación, ha sido obtenida por fuentes confiables y oficiales, consideramos que es correcta, sin embargo no asumimos ninguna responsabilidad por errores, cambios, omisiones o daños que resultaran de estos".



# Cables Selector de Velocidades / Transhift Cables



NUMERO DE PARTE PART NUMBER	NUMERO DE CLIENTE CUSTOMER NUMBER	AÑO / YEAR	VEHICULO / VEHICLE	LONG. A
GM862	22588370	1995	C. SEL DE VEL CAVALIER PALANCA AL PISO T AUT (MEXICO)	1335
GM863	22737100	97-99	C. SEL DE VEL PONTIAC SUNFIRE PALANCA AL PISO T AUT	1290
GM864	15713353		C. SEL DE VEL JIMMY BRAVADA (USA) TRANS AUT	2805
GM865	15730543	1997	C. SEL DE VEL BLAZER PALANCA AL PISO (USA) TRANS AUT	2385
GM866		1990	C. SEL DE VEL LUMINA MINIVAN TRANS AUT	1675
GM867	322-U3	1994	C. SEL DE VEL SILHOUETTE TRANS AUT	1675
GM868			C.SEL CUTLASS, CELEBRITY, CENTURY, CITATION T AUT	1400
GM869	15721261	1996	C. SELECTOR DE VELOCIDADES BLAZER (USA) TRANS AUT	2575
GM870	15996434	1995	C. SELECTOR DE VEL BLAZER 4.3L 6C (USA) TRANS AUT	2535
GM871	15996435	1995	C. SELECTOR DE VEL BLAZER (USA) TRANS AUT	2140
GM872	12558518	1997	C. SELECTOR DE VEL VENTURE 6CIL TRANS AUT	1555
GM889	15733420	1996	C. SELECTOR DE VEL CHEVROLET ASTRO 6CIL 4.3L T AUT	2935



GM873	22616589	1998	C. SELECTOR DE VEL PONTIAC GRAND AM (MEXICO) T AUT	2830
GM874		1994	C. SELECTOR DE VEL BERETTA Z26 (USA) TRANS AUT	2280
GM875	22615277	2000	C. SELECTOR DE VEL MALIBU 6CIL (MEXICO) TRANS AUT	2708
GM876	313-T4B	1995	C. SELECTOR DE VEL CUTLASS EUROSPOUT TRANS AUT	2575
GM877	3284TD	1995	C. SELECTOR DE VEL PONTIAC TRANS AM (USA) TRANS AUT	725
GM878	046T6B	1998	C. SELECTOR DEVEL PONTIAC GRAND AM (MEXICO) T AUT	2240



GM879		2000	C. SELECTOR DE VELOCIDADES CORVETTE	1010
GM880		95-98	C. SELECTOR DE VEL SILVERADO, SIERRA, TAHOE 4x4 T AUT	2779
GM881		2001	C. SELECTOR DE VEL CAN EXPRESS 2500 (MEXICO) T AUT	3525

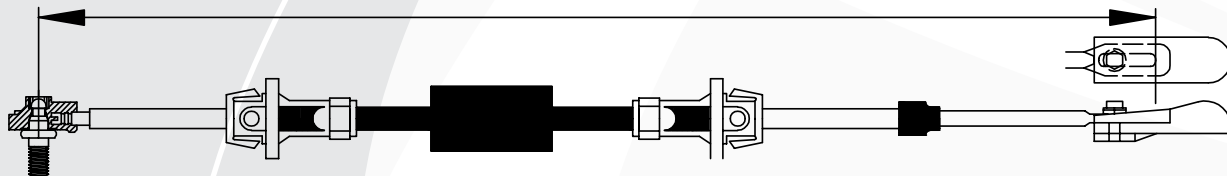

GM882		96-99	C. SEL DE VEL CHEVROLET S10, BLAZER 4x4 (DOBLE TRACCION)	825
-------	--	-------	--	-----



\*Importante: La informacion indicada en esta publicacion, ha sido obtenida por fuentes confiables y oficiales, consideramos que es correcta, sin embargo no asumimos ninguna responsabilidad por errores, cambios, omisiones o daños que resulten de estos.

NUMERO DE PARTE PART NUMBER	NUMERO DE CLIENTE CUSTOMER NUMBER	AÑO / YEAR	VEHICULO / VEHICLE	LONG. A
GM883		96-98	C. TRANSVERSAL CAVALIER PONTIAC SUNFIRE 5VEL FUEL INJ	1510
GM884		95-98	C. SELECTOR DE VEL SUNFIRE 5 VEL, CAVALIER FUEL INJ	1515
GM885	134W9B	96-98	C. SELECTOR DE VEL CAVALIER Z24 FUEL INJ	1470
GM886	155W7B	96-97	C. SELECTOR DE VEL PONTIAC GRAND AM 4CIL 5VEL	1310
GM887		95-98	C. SELECTOR DE VEL CAVALIER FUEL INJ AMERICANO	1470
GM888		2004	C. TRANSVERSAL ASTRA 4 CILINDROS TRANS STD	1205
GM890	12T5B	1994	C. SEL DE VEL PONTIAC GRAND AM TRANS AUT AL PISO USA	2012
GM891		2003-AD	C. TRANSVERSAL PONTIAC MATIZ 4CIL TRANS STD	970

\*Importante: La información indicada en esta publicación, ha sido obtenida por fuentes confiables y oficiales, consideramos que es correcta, sin embargo no asumimos ninguna responsabilidad por errores, cambios, omisiones o daños que resultaran de estos.



# Cables Selector de Velocidades / Transhift Cables



NUMERO DE PARTE PART NUMBER	NUMERO DE CLIENTE CUSTOMER NUMBER	AÑO / YEAR	VEHICULO / VEHICLE	LONG. A
GM892		2003-AD	C. SELECTOR DE VEL PONTIAC MATIZ 4 CIL TRANS STD	1030

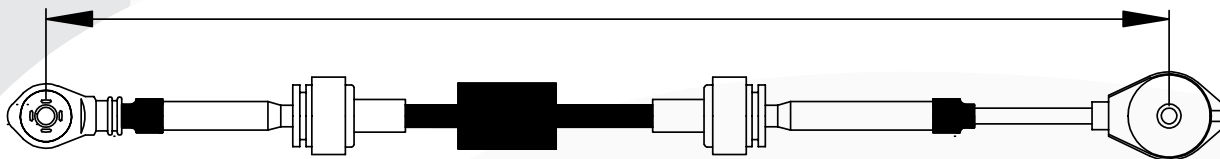

GM893	22575723	1994	C. TRANSVERSAL PONTIAC GRAND AM 2.3L 4CIL T STD	1195
GM894	22578976	93-94	C. TRANSVERSAL CAVALIER TRANS STD	1238

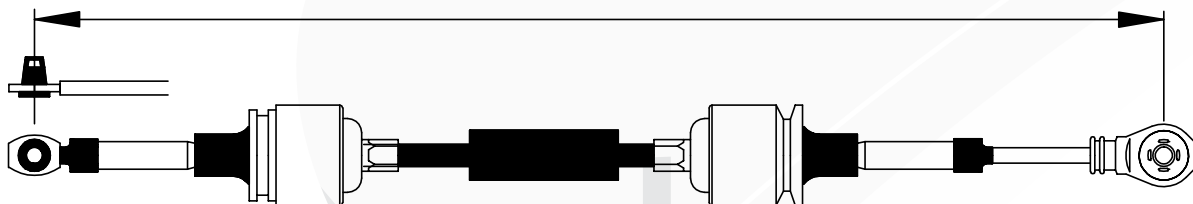

GM895	22575723	1981	C. SEL DE VEL CHEVROLET MALIBU 6CIL TRANS AUT	610
GM896		1978	C. SEL DE VEL CAMARO, TRANS AM, FIREBIRD TRANS AUT	805



GM897	183T5B	96-98	C. TRANSVERSAL CAVALIER Z24 FUEL INJ TRANS STD (MEX)	1466
GM898		1993	C. TRANSVERSAL CAVALIER FUEL INJ TRANS STD (USA)	1510

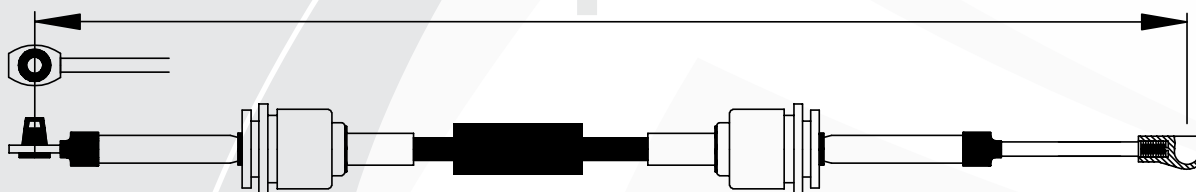

GM899	10066457	1983	C. SEL DE VEL BUICK, CENTURY AMERICANO	1120
GM8100	10079793	1989	C. SEL DE VEL CAVALIER, CELEBRITY 2.8L (USA) TRANS STD	1465
GM8101			C. SEL DE VEL CELEBRITY TRANS STD	1215
GM8102		1988	C. SEL DE VEL CITATION AMERICANO TRANSMISION STD	1268



\*Importante: La información indicada en esta publicación, ha sido obtenida por fuentes confiables y oficiales, consideramos que es correcta, sin embargo no asumimos ninguna responsabilidad por errores, cambios, omisiones o daños que resulten de estos.

NUMERO DE PARTE PART NUMBER	NUMERO DE CLIENTE CUSTOMER NUMBER	AÑO / YEAR	VEHICULO / VEHICLE	LONG. A
GM8103		90-96	C. SECTOR DE VEL SILVERADO, SIERRA TAHOE 4X4 TRANSMISION AUTOMATICA	2779

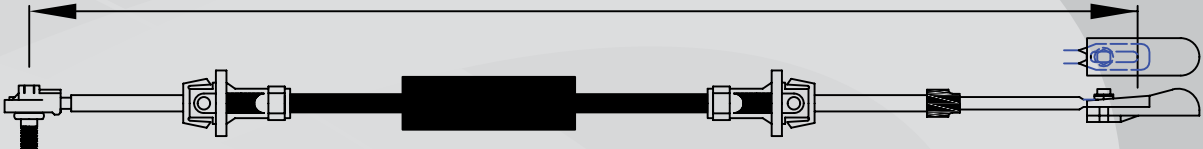

**PRODUCTO NUEVO**

GM8104		1996	C. SECTOR DE VEL PONTIAC SUNFIRE	2012
--------	--	------	----------------------------------	------

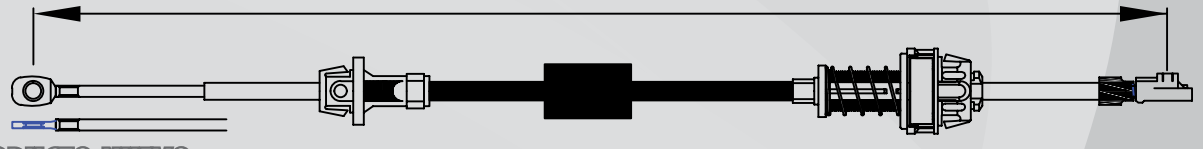

**PRODUCTO NUEVO**

GM8106		1995	C. SECTOR DE VEL CAMARO T. AUT.	725
--------	--	------	---------------------------------	-----



**PRODUCTO NUEVO**



NUMERO DE PARTE PART NUMBER	NUMERO DE CLIENTE CUSTOMER NUMBER	AÑO / YEAR	VEHICULO / VEHICLE	LONG. A
HY800		TODOS	JUEGO DE CABLES SECTOR DE VEL HYUNDAI H100	1770 1865

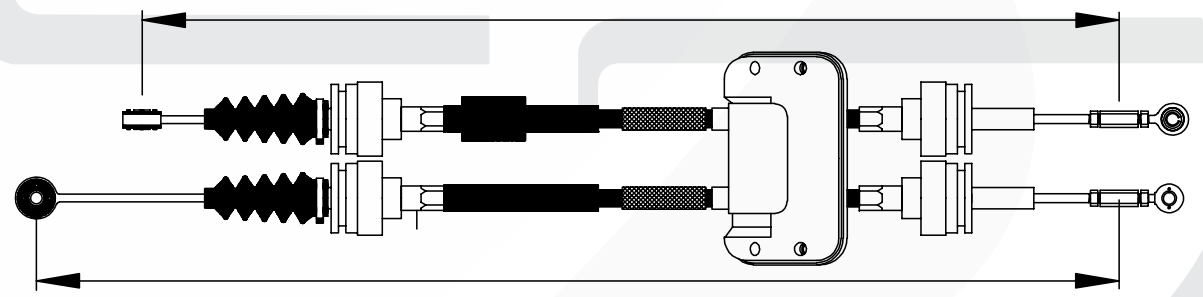

HY801		TODOS	JUEGO DE CABLES SECTOR DE VEL HYUNDAI ACCENT	1172 1145
HY803	43794-22010	94-99	C. CAJA DE VELOCIDADES HYUNDAI ACCENT	1115/1150
HY804	43794-29010	96-00	C. CAJA DE VELOCIDADES HYUNDAI ELANTRA	1188/1227
HY805	43794-28007	92-95	C. CAJA DE VELOCIDADES HYUNDAI ELANTRA	1303/1316

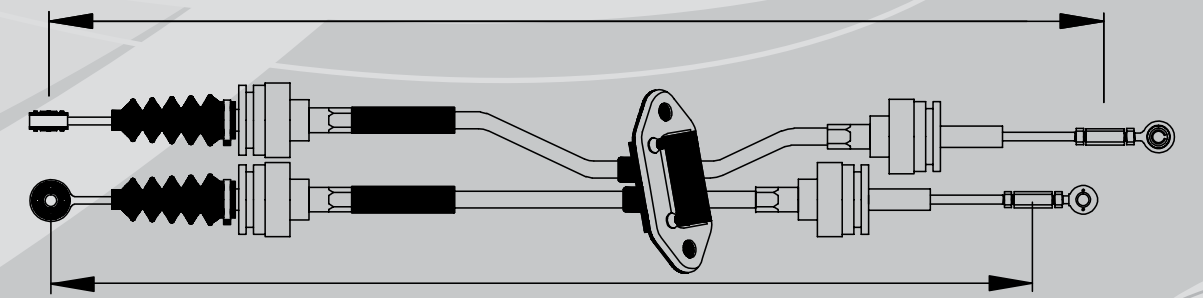

**PRODUCTO NUEVO**

"Importante: La información indicada en esta publicación, ha sido obtenida por fuentes confiables y oficiales, consideramos que es correcta, sin embargo no asumimos ninguna responsabilidad por errores, cambios, omisiones o daños que resultaran de estos".

NUMERO DE PARTE PART NUMBER	NUMERO DE CLIENTE CUSTOMER NUMBER	AÑO / YEAR	VEHICULO / VEHICLE	LONG. A
HY802	43770-4B100	1997	JUEGO DE CABLES SELECTOR DE VEL HYUNDAI HY-PORTER	1645 / 1780
HY807	43770-4B300	98-	CABLE SEL DE VEL HY PORTER	1659 / 1796

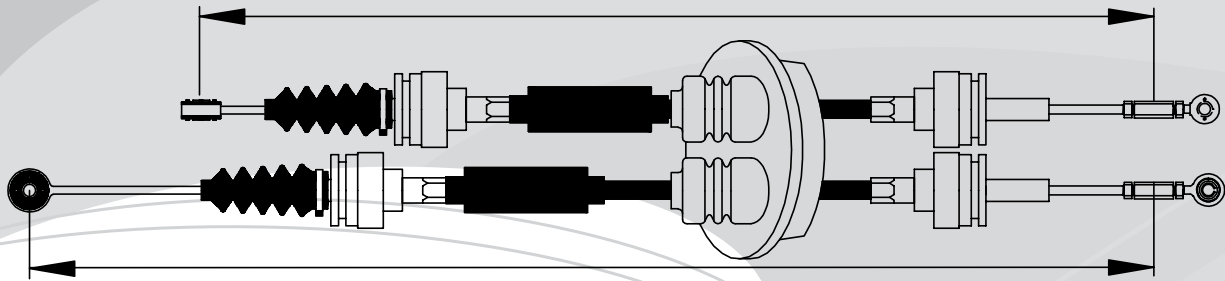

**PRODUCTO NUEVO**

NUMERO DE PARTE PART NUMBER	NUMERO DE CLIENTE CUSTOMER NUMBER	AÑO / YEAR	VEHICULO / VEHICLE	LONG. A
HN800		95-97	C. SELECTOR DE VEL HONDA ACCORD 4 CIL TRANS STD	1415
HN801		95-97	C. TRANSVERSAL DE VEL HONDA ACCORD 4 CIL TRANS STD	1310



## KIA MOTORS

NUMERO DE PARTE PART NUMBER	NUMERO DE CLIENTE CUSTOMER NUMBER	AÑO / YEAR	VEHICULO / VEHICLE	LONG. A
KI-800	K801080	98-	CABLE DE SEL. VEL. KIA PREGIO 2.7	2227
KI-801	OK65J-46-600C		CABLE DE SEL. VEL. KIA K400 WIDE 95 / 79	2108

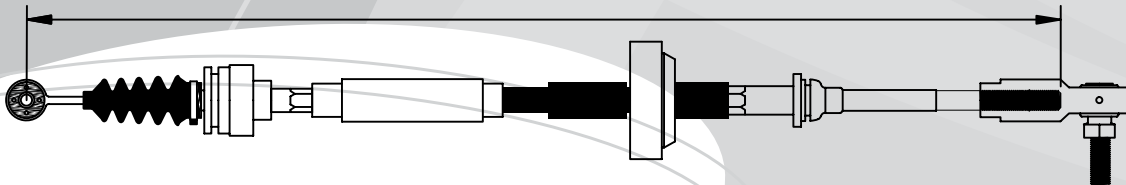

**PRODUCTO NUEVO**

NUMERO DE PARTE PART NUMBER	NUMERO DE CLIENTE CUSTOMER NUMBER	AÑO / YEAR	VEHICULO / VEHICLE	LONG. A
NV800	871301C1	1994	C. SELECTOR MOT 466 NAVISTAR 4700, PASSINGER TRANS AUT	3632

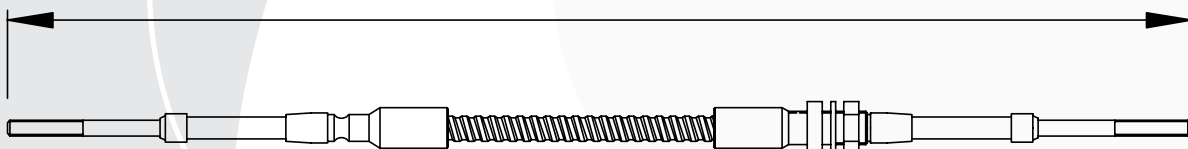

"Importante: La información indicada en esta publicación, ha sido obtenida por fuentes confiables y oficiales, consideramos que es correcta, sin embargo no asumimos ninguna responsabilidad por errores, cambios, omisiones o daños que resulten de estos."

NUMERO DE PARTE PART NUMBER	NUMERO DE CLIENTE CUSTOMER NUMBER	AÑO / YEAR	VEHICULO / VEHICLE	LONG. A
NI800	94935-51A00	89-92	C. SEL DE VEL NISSAN TSURU II TRANS AUTOMATICA	1208
NI801		TODOS	C. SEL DE VEL NISSAN SENTRA AMERICANO TRANS AUT	1233
NI806	508J31A	87-91	C. SECTOR DE VEL NISSAN ICHIVAN TRANS AUT	1804
NI807		98-99	C. SEL DE VEL MAXIMA (AMERICANO) PALANCA AL PISO T. AUT	945



NI802			C. SECTOR DE VELOCIDADES TSURU III TRANS AUT	1567
NI804	34935-92Y15	1993	C. SECTOR DE VEL NISSAN TSUBAME TRANS AUT (MEXICO)	1582
NI805		1995	C. SECTOR DE VELOCIDADES NISSAN SENTRA TRANS AUT (MEX)	1705

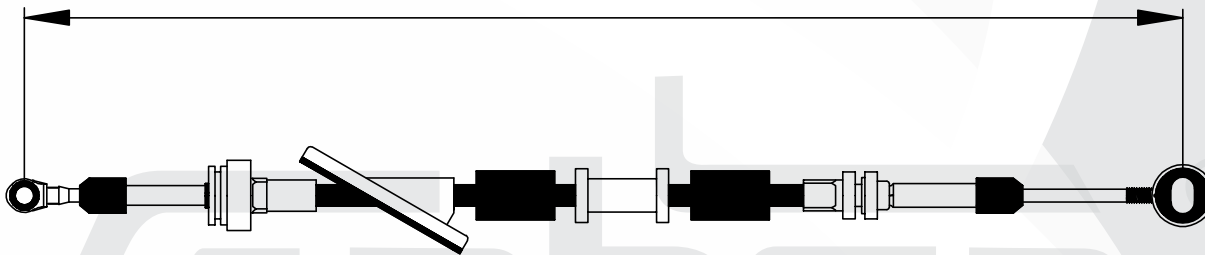

NI803		86-88	C. SECTOR DE VELOCIDADES NISSAN TSURU I TRANS AUT	1573
-------	--	-------	---	------

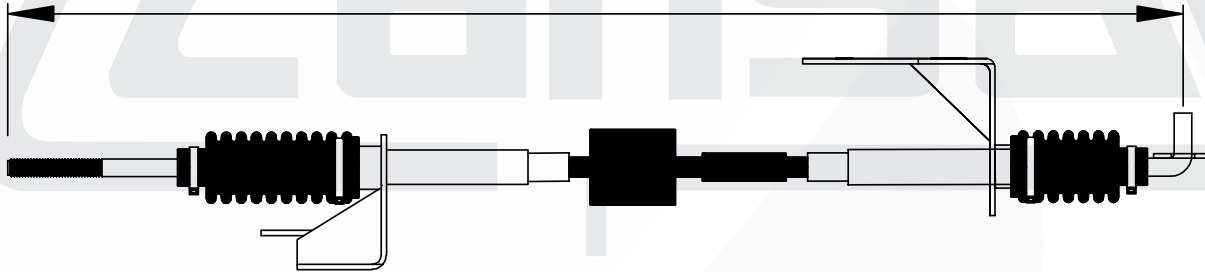

NI808		1993	C. SEL DE VEL PICK UP TRANS PALANCA AL PISO (USA) T AUT	1395
-------	--	------	---	------

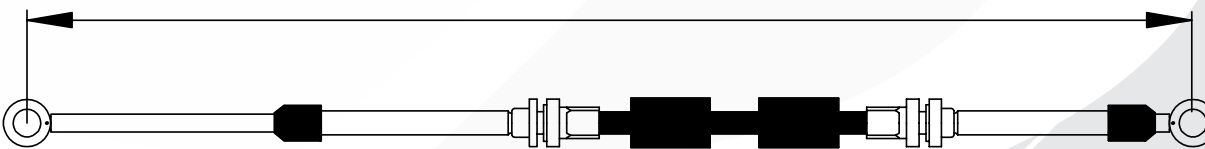

NI809		2006	C. SECTOR DE VEL NISSAN ALTIMA TRANS AUT	1915
-------	--	------	--	------

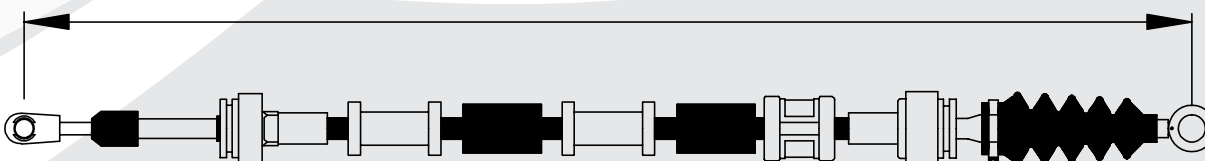

"Importante: La información indicada en esta publicación, ha sido obtenida por fuentes confiables y oficiales, consideramos que es correcta, sin embargo no asumimos ninguna responsabilidad por errores, cambios, omisiones o daños que resultaran de estos".

Cables Selector de Velocidades / Transhift Cables



# Cables Selector de Velocidades / Transhift Cables



NUMERO DE PARTE PART NUMBER	NUMERO DE CLIENTE CUSTOMER NUMBER	AÑO / YEAR	VEHICULO / VEHICLE	LONG. A
NI810		2004	C. SELECTOR DE VEL. NISSAN MURANO V6 35L 24V TRANS AUT	1912
NI811		99-02	C. SELECTOR DE VEL. NISSAN FRONTIER TRANS AUT	2095

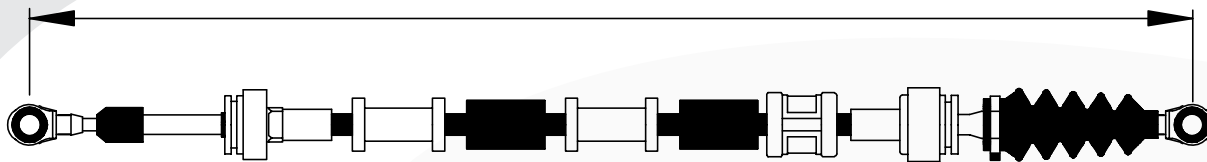

NUMERO DE PARTE PART NUMBER	NUMERO DE CLIENTE CUSTOMER NUMBER	AÑO / YEAR	VEHICULO / VEHICLE	LONG. A
NI813	34935-EM30A	2006-	C. SELECTOR DE VEL. NISSAN TIIDA TRASN. AUT.	1732

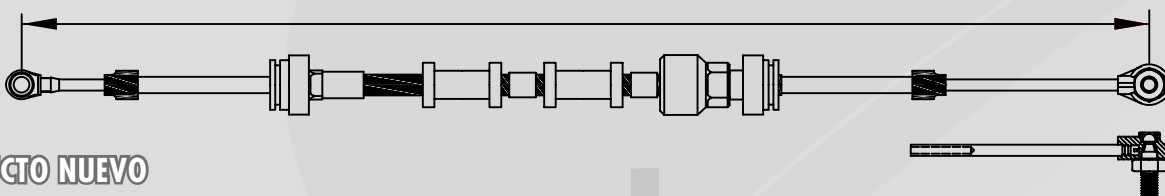

**PRODUCTO NUEVO**

NUMERO DE PARTE PART NUMBER	NUMERO DE CLIENTE CUSTOMER NUMBER	AÑO / YEAR	VEHICULO / VEHICLE	LONG. A
NI815	34445-EM32A	2006-	C. SELECTOR DE VEL. NISSAN TIIDA TRASN. STD.	1095

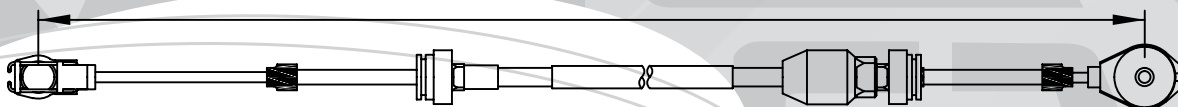

**PRODUCTO NUEVO**

## PEUGEOT

NUMERO DE PARTE PART NUMBER	NUMERO DE CLIENTE CUSTOMER NUMBER	AÑO / YEAR	VEHICULO / VEHICLE	LONG. A
PG800		00-02	C. SELECTOR DE VEL. PEUGEOT 307	995



## TOYOTA

NUMERO DE PARTE PART NUMBER	NUMERO DE CLIENTE CUSTOMER NUMBER	AÑO / YEAR	VEHICULO / VEHICLE	LONG. A
TY800		93-94	C. SELECTOR DE VEL. TOYOTA PICK UP TERCEL TRANS AUT	1600

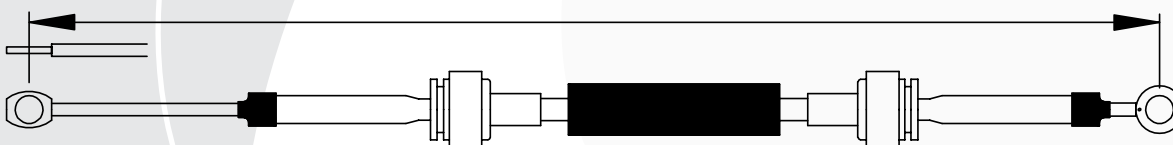

"Importante: La información indicada en esta publicación, ha sido obtenida por fuentes confiables y oficiales, consideramos que es correcta, sin embargo no asumimos ninguna responsabilidad por errores, cambios, omisiones o daños que resulten de estos."

NUMERO DE PARTE PART NUMBER	NUMERO DE CLIENTE CUSTOMER NUMBER	AÑO / YEAR	VEHICULO / VEHICLE	LONG. A
VW800	171713565C		C. SELECTOR VW CARIBE TRANS AUT DE LA PALANCA A LA CAJA	1535
VW801	171713565D		C. SELECTOR VW JETTA TRANS DE LA PALANCA A LA CAJA	1630

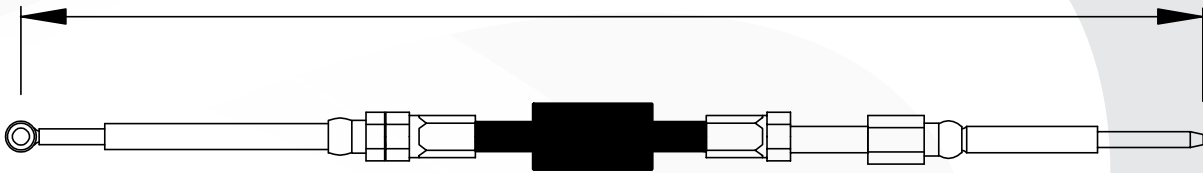

VW802	811713265	TODOS	C. SELECTOR VW CORSAR	632
-------	-----------	-------	-----------------------	-----

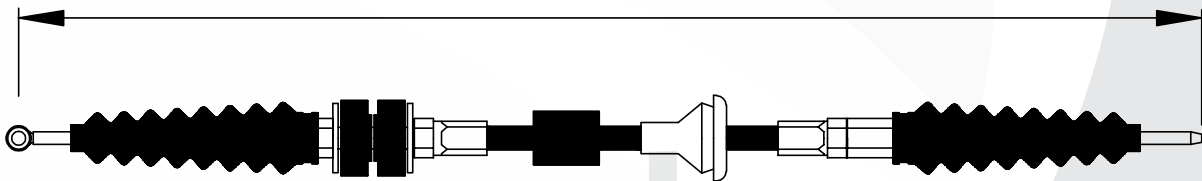

VW803	6Q0711266K	02-AD	C. SELECTOR DE VELOCIDADES VW POLO (CORTO) MEXICO	1101
-------	------------	-------	---	------

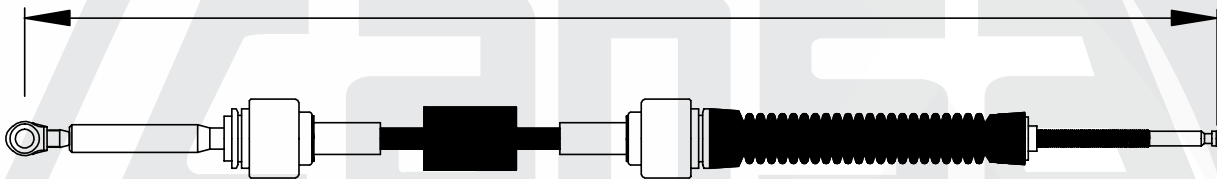

VW804	6Q0711265AL	02-AD	C. SELECTOR DE VELOCIDADES VW POLO (LARGO) MEXICO	1223
-------	-------------	-------	---	------

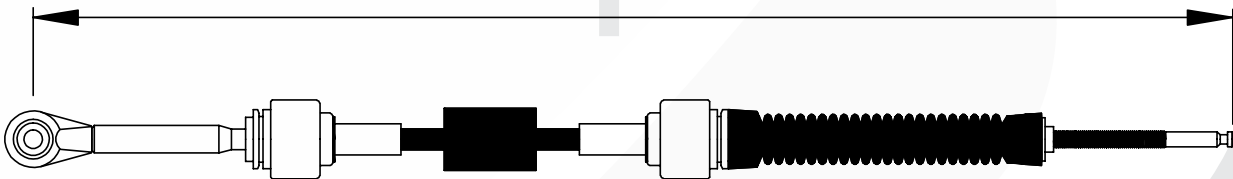

VW805		93-98	C. SELECTOR DE VEL VW JETTA A3	1225
-------	--	-------	--------------------------------	------



"Importante: La información indicada en esta publicación, ha sido obtenida por fuentes confiables y oficiales, consideramos que es correcta, sin embargo no asumimos ninguna responsabilidad por errores, cambios, omisiones o daños que resultaran de estos".



# Cables Selector de Velocidades / Transhift Cables



NUMERO DE PARTE PART NUMBER	NUMERO DE CLIENTE CUSTOMER NUMBER	AÑO / YEAR	VEHICULO / VEHICLE	LONG. A
VW806		93-98	C. SELECTOR DE VEL VW PASSAT, JETTA (AMERICANO) T. STD	1185

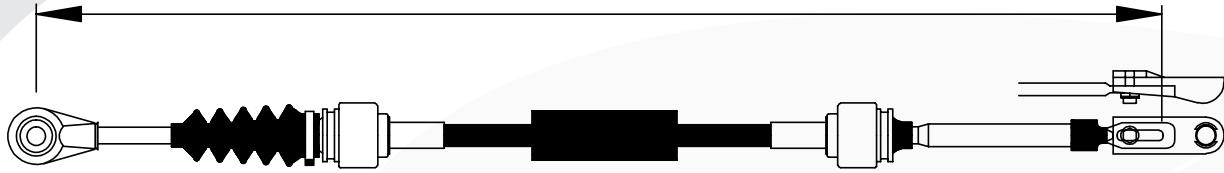

VW807	6Q0 711 266H	95-AD	C. SELECTOR DE VEL. VW DERBY	1120
-------	--------------	-------	------------------------------	------



PRODUCTO NUEVO

VW808	6Q0 711 266H	95-AD	C. TRANSVERSAL DE VEL. VW DERBY	1273
-------	--------------	-------	---------------------------------	------

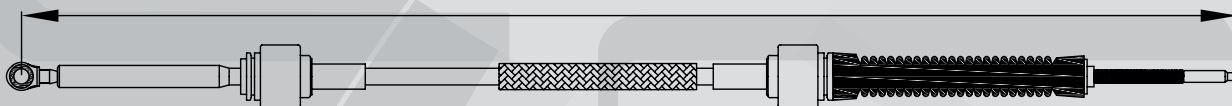

PRODUCTO NUEVO

VL800	MP710120	TODOS	CABLE SELECTOR DE VELOCIDADES VOLVO C11	2261
-------	----------	-------	---	------

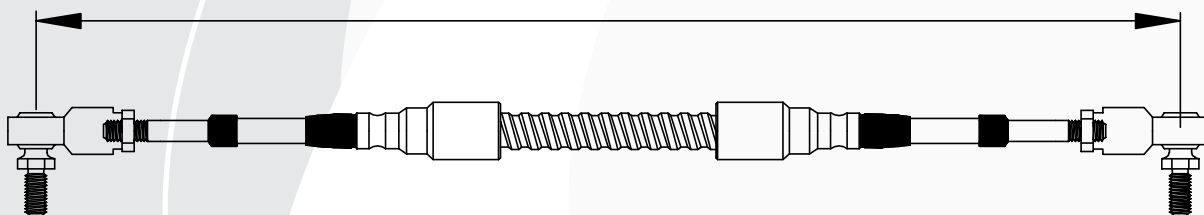

"Importante: La información indicada en esta publicación, ha sido obtenida por fuentes confiables y oficiales, consideramos que es correcta, sin embargo no asumimos ninguna responsabilidad por errores, cambios, omisiones o daños que resulten de estos."

Cables Selector de Velocidades / Transhift Cables



The page features a large, semi-transparent watermark of the Cahnsa logo. The logo consists of a stylized, rounded 'C' shape on the left, followed by the word 'cahnsa' in a bold, lowercase, sans-serif font. A registered trademark symbol (®) is located to the right of the word. The watermark is centered horizontally and vertically on the page, overlaid on the lined writing area.

**“Los productos mexicanos, a pesar de lo que se pueda pensar, tienen una gran aceptación en el mundo y es nuestra responsabilidad mantener y hacer crecer esa reputación, garantizando nuestras exportaciones con la mas alta calidad y un excelente servicio”.**

**“Y esa misma actitud es la que debemos asumir en el mercado nacional, fabricar productos de alta calidad que hagan renacer o que refuercen la confianza de los mexicanos en los productos hechos en el país, porque no importa que los fabricantes tengan o no grandes recursos económicos, lo verdaderamente fundamental es que TU, como fabricante, como distribuidor, como usuario final, asumas una actitud positiva, creciendo día con día, mejorando continuamente para demostrar que ser MEXICANO, ES UN ORGULLO”.**

## **NUESTRA MISIÓN**

**Lograr el grado más alto de EXCELENCIA en nuestros campos de acción, que significa sobresalir en lo hacemos de aquellos con quienes competimos, hacer mejor las cosas que los demás.**

**Para lograrlo tenemos que sentir el propósito y el rumbo que perseguimos, así como tener un profundo entendimiento de los valores fundamentales que motivan a nuestra organización.**

**Nuestra misión y valores fundamentales son guía permanentes para reforzar nuestras relaciones con empleados, clientes, proveedores, autoridades y accionistas.**

**LA EXCELENCIA EMPIEZA CON LA ACTITUD.**

**HUMBERTO CRUZ BADILLO**  
**Director General grupo ENEJH**

# **México a la vanguardia**



# cahsa<sup>®</sup>

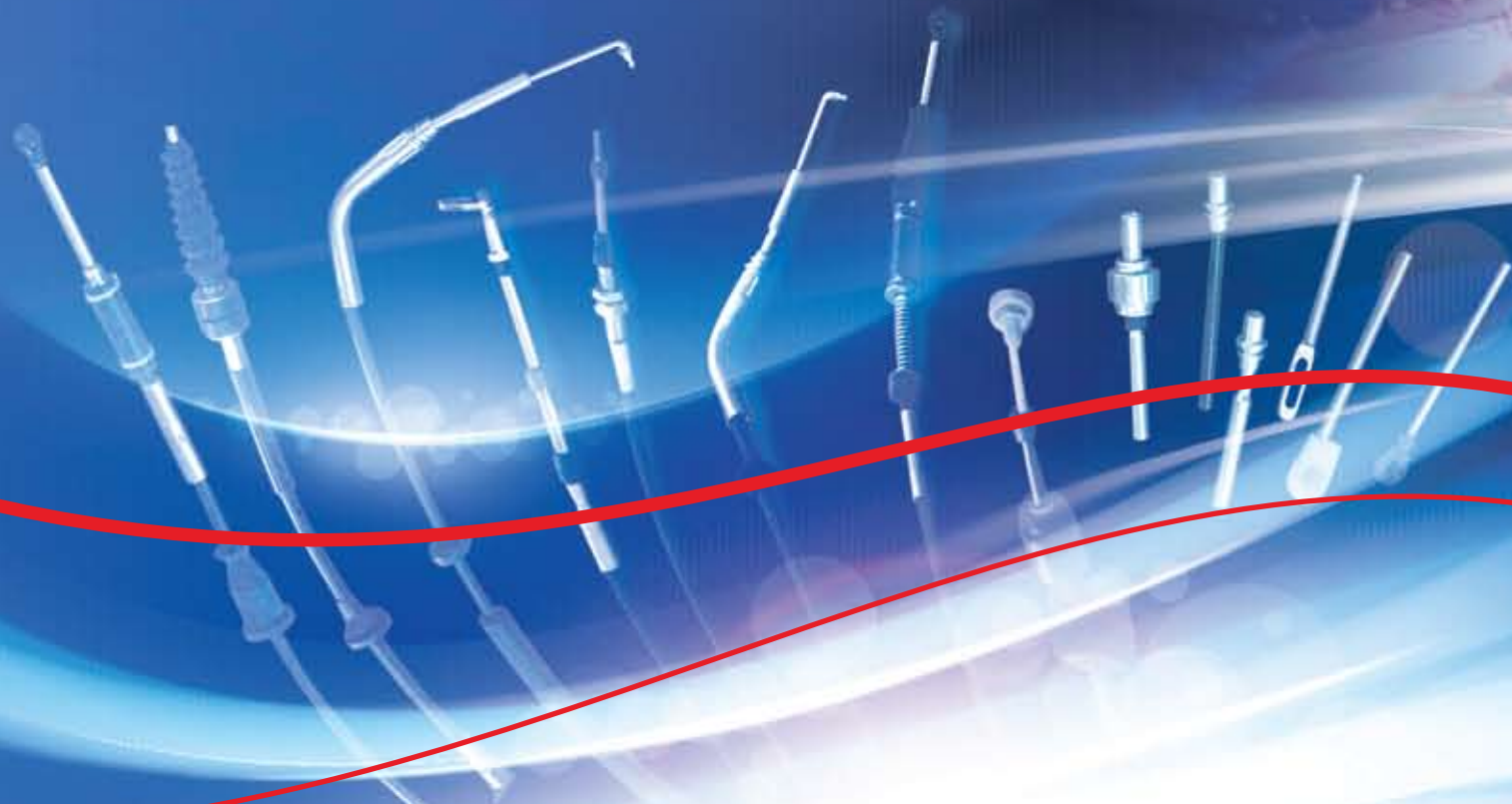

**2011 Copyright Derechos Reservados.**  
**Cables Automotrices de Hidalgo S.A. de C.V.**  
Calle 8 de Blvd. a Querétaro 9,  
Col. Viveros del Valle Tlalnepantla,  
Edo. de Méx, C.P. 54060, México  
Tel: + 52(55) 5362 6270  
Fax: + 52(55) 5365 7627



[www.enejh.com](http://www.enejh.com)  
[pedidos@enejh.com](mailto:pedidos@enejh.com)