



BÖKER

MANUFAKTUR SOLINGEN

YOUR KNIFE

OUTDOOR & COLLECTION 1-2013

INNOVATIVE SPORTING KNIVES

VALUABLE COLLECTORS PIECES

TACTICAL KNIVES FOR PROFESSIONALS

THE BOKER PLUS
COLLECTION 2013
See page 61.



Become a fan on Facebook by scanning the QR code with your smart phone!

THE BOKER PLUS MANARO: *See page 55.*



THE BOKER 2013 ANNUAL DAMASCUS COLLECTORS KNIFE: *See page 6.*



BOKER USA, INC. • OUTDOOR & COLLECTION 1-2013

THE BOKER KNIFE MANUFACTORY IN SOLINGEN, GERMANY... TRUSTED SINCE 1869.

Dan Weidner, President of Boker USA, Inc.



Greetings from Colorado! Is it just me, or are you asking the same question - where did 2012 go? Maybe someone out there can figure out a way to slow things down a bit. But until then, we're all on the train together.

Reading over a cover letter from 2008, we had a presidential campaign that seemed to last forever. We had floods here and

droughts there. We had turmoil in the Middle East and tragic happenings here on our own soil. Maybe a common resolution for 2013 would be for all of us to come together in an attempt to make this world a better and safer place to live.

Despite all the distractions, the outdoor industry that we all enjoy is healthy. Statistics show

that Americans will spend over \$600 billion on outdoor interests this year. Sales of hunting licenses are up. As part of the industry, Boker, in turn, continues to see healthy and profitable growth - thanks to all of you who support us.

Once again, our new catalog is chock full of new and exciting product, in every category - hunting, tactical, collectibles, camping, or just general everyday carry knives. The front cover is graced with the 2013 Boker Plus Collectors knife, a design by E. Scott McGhee of North Carolina. New collaborations with Sal Manaro, Davis Curtiss, Jeremy Marsh, Mickey Yurco and Jared Price add to our team of esteemed custom designers and knifemakers. Jens Ansø and Chad Nichols team up to present the annual Solingen Damascus Collectors knife. Simply stunning is the best way to describe this piece.

Our Magnum brand offers everything from hunting to tactical, at a price point for quick

and steady turnover. Back by popular demand are the Boker Plus series of flashlights, featuring new and innovative designs that offer phenomenal performance at a very attractive price. Simply compare to the others out there and you will see.

In short, there is something for everyone in this catalog. Take a few minutes and check it out. Also, review the 2013 pricing as there is a modest price increase on most items. Once again, all of us at Boker USA want to thank you for your support. We look forward to increased growth and a healthy and prosperous 2013.

Best regards,

Dan Weidner, President
BOKER USA, INC.



The Boker Manufactory in Solingen, Germany

BOKER MANUFACTORY SOLINGEN



The Premium Brand: Since 1869, only the very best in sporting and collectible knives are made in the Boker manufacturing plant in Germany.

- ▶ Damascus & collector's knives 6-17, 156
- ▶ Hunting & outdoor knives 18-27, 30,32-35
- ▶ Tactical knives 19-23, 28-29
- ▶ Classic pocket knives 31, 36-45
- ▶ Cinch® 46-47

▶ Page 4

BOKER MANUFACTORY SOLINGEN

BOKER ARBOLITO



Tradition: Since 1983 the BOKER subsidiary produces high quality hunting and kitchen knives. In Spanish speaking areas of North and South America, ARBOLITO has a great reputation.

- ▶ Hunting & outdoor knives 48-53

▶ Page 48

BOKER ARBOLITO

BOKER PLUS



Innovation: Outstanding, innovative knife concepts for every mission. Designed in cooperation with knife experts worldwide. German engineering, manufactured in Taiwan and China.

- ▶ Tactical knives 55-67, 70-73, 76-94
- ▶ Collector's knives 61, 76-77, 90-91
- ▶ Outdoor knives 58-60, 68-75, 94-97
- ▶ Damascus knives 95
- ▶ Pocket knives 98-99

▶ Page 54

BOKER PLUS

MAGNUM BY BOKER



Affordable Performance: Well known brand with attractive designs, impressive quality and an outstanding price-performance ratio. Manufactured in Taiwan and China.

- ▶ Hunting & outdoor knives 111, 116-123, 136
- ▶ Damascus knives 102-103, 124-125
- ▶ Classic folding knives 112-113, 116-117
- ▶ Tactical knives 101, 104-109, 114-115, 126-135
- ▶ Throwing knives 137
- ▶ Swords 138-139

▶ Page 100

MAGNUM BY BOKER

ACCESSORIES



Equipment: The details that make life easier.

- ▶ Tactical pens 141
- ▶ Pocket sticks 145
- ▶ Flashlights 142-143
- ▶ Weatherproof notebooks 144
- ▶ Sharpeners 146-148
- ▶ Sheaths 152-153
- ▶ Tool kits 149
- ▶ Lanyards 150
- ▶ Survival bracelets 151
- ▶ Boker merchandising 154-155
- ▶ Letter openers 156

▶ Page 140

ACCESSORIES



BOKER
MANUFAKTUR SOLINGEN

The Premium Brand:

Since 1869, only the very best in sporting and collectible knives are made in the Boker manufacturing plant in Germany.

[Pages 4-47]





1 BOKER MINOS. A new dimension titanium frame lock! Designed by Jens Ansø with maximum stability, the Minos convinces with solid 4mm titanium plates and a 5mm thick blade, made of N690BO steel. To emphasize the construction, the pocket clip, spacer and thumb rest are also milled of titanium. In order to effectively prevent any torsion inside the handle, additional screws were added to the scales, eliminating any potential weak points. If you are looking for a stable pocket knife, this is it! The deep milled grooves offer a high level of grip, and guarantee safe handling. Due to the slight hollow grind, the bellied blade provides excellent cutting capabilities. Whether it is used for outdoor, everyday use, professional or hunting purposes - with the Minos you are perfectly equipped. The special blade finish harmonizes with the anodized titanium handle, and provides a unique appearance. All in all, an uncompromising tool that will never let you down. Blade length: 3 1/8". Overall length: 7 3/8". Weight: 6.5 oz. Item No. 110629 \$ 429.00



Titanium frame lock and titanium pocket clip.

1
Boker Minos.
\$ 429.00

2 BOKER MINOS II. The classic version of the original Minos (model 110629) convinces as a hunting knife as well as a solid pocket knife. Working with the Minos II is even more comfortable, due to a reduced thickness of the handle, which is equipped with stainless steel bolsters on a massive steel liner. The scales are crafted of handsome Grenadill wood, and the N690BO stainless steel blade locks with the sturdy liner lock mechanism. Includes removable pocket clip (tip-down). Blade length: 3 1/8". Overall length: 7 3/8". Weight: 8.1 oz. Item No. 111629 \$ 219.00



Production
Prototype
Picture

2
Boker Minos II.
\$ 219.00

3 BOKER ARCTOS. The first true hunting pocket knife by Jens Ansø. The round bodied and solid blade is made of N690BO stainless steel. Its compact dimensions offer effective and secure use. The handle scales are made of brushed canvas Micarta, and offer a strong and secure grip, even with wet hands. Also features titanium liners and a solid liner lock mechanism. Blade length: 2 7/8". Overall length: 6 3/4". Weight: 4.8 oz. Item No. 110632 \$ 259.00



Production
Prototype
Picture

3
Boker Arctos.
\$ 259.00

4 BOKER ARCTOS 42. The elegant version of the Arctos (model 110632) by Jens Ansø impresses with its slim profile and grained olive wood handle scales, set off by the brushed stainless steel bolsters. The solid steel liners house the sturdy liner lock mechanism. The satin finished blade is crafted of N690BO stainless steel and features a nail nick for added functionality. Blade length: 2 7/8". Overall length: 6 3/4". Weight: 5.9 oz. Item No. 111632 \$ 195.00



Production
Prototype
Picture

4
Boker Arctos 42.
\$ 195.00



BÖKER
MANUFATUR SOLINGEN

Classic and collectible.

NEW

2013 ANNUAL
DAMASCUS
COLLECTORS PIECE



1 Boker 2013 Annual Damascus Collectors Knife. \$ 519.00



2 Boker 2011 Annual Damascus Collectors Knife. \$ 619.00

3 Boker 2012 Annual Damascus Collectors Knife. \$ 579.00



W.C. Davis

1 BOKER 2013 ANNUAL DAMASCUS COLLECTORS KNIFE. This year's annual Damascus collector's knife is based on one of Jens Anso's new models, the Solo. To make this a real collectible piece, we chose handsome desert ironwood for the handle, which is accented with the brushed stainless steel bolsters and solid stainless steel liners. Chad Nichols' stainless "Riptide Damascus" provides an attractive contrast and unique appearance. This valuable collector's piece is handmade in

Solingen, Germany and is strictly limited to just 999 pieces worldwide. Comes in an attractive wooden presentation box with a certificate of authenticity. Blade length: 2 $\frac{7}{8}$ ". Overall length: 6 $\frac{1}{2}$ ". Weight: 5.4 oz. Item No. 1132013DAM \$ 519.00

2 BOKER 2011 ANNUAL DAMASCUS COLLECTORS KNIFE. The annual Boker Damascus Collectors piece breaks new ground. The 2011 model is based on the custom design "Thorn" from Mississippi

knifemaker Jim Burke, whose designs so far have been more on the tactical side of knifemaking. The Thorn inherits elements of this, but is nevertheless a real gentleman's knife with elegant, flowing lines. The blade, with a thickness of more than $\frac{1}{8}$ ", is made of hand forged stainless Damascus (300 layers), showing the "Raindrop pattern," forged by Damascus forger Chad Nichols. The elegant brushed stainless steel bolsters blend perfectly with the Damascus blade, and the desert ironwood scales provide a most appealing look. The blade is opened with the characteristic nail nick and

locks with a liner lock. With lanyard hole (no pocket clip). Limited to just 999 pieces worldwide. Blade length: 2 $\frac{7}{8}$ ". Overall length: 6 $\frac{1}{4}$ ". Weight: 3.6 oz. Item No. 1132011DAM \$ 619.00

3 BOKER 2012 ANNUAL DAMASCUS COLLECTORS KNIFE. This Damascus Annual Collector's knife is based on the Classic Hunter design by W.C. Davis, and offers, with its ageless design, not only an extraordinary collector's piece, but also a high grade user's knife for everyday carry. The stainless Damascus, forged by hand from Chad



4
Boker Haddock
Damascus.
\$ 825.00



5
Boker Merlin
Damascus.
\$ 619.00



6
Boker Merlin.
\$ 329.00



Gorski's Interlock System

Nichols from Mississippi, offers not only a stunning "Ladder" pattern, but also gives superior cutting capability and outstanding edge retention with its hollow grind. The clear and even design lines and the traditional style combine amazingly with the polished stainless steel bolsters and the white Micarta handle scales, where black spacers provide a beautiful contrast. Also features a sturdy lockback mechanism and lanyard hole. Handmade in the Boker Manufactory in Solingen, Germany, and strictly limited to just 999 pieces worldwide. Comes in a presentation box with a certificate of authenticity. Blade length: 3½". Overall length: 8¾". Weight: 5.3 oz. Item No. 1132012DAM \$ 579.00

4 BOKER HADDOCK DAMASCUS. This design, by Denmark's Jens Anso, takes on a very special twist with a striking stainless Damascus pattern named the "Bjork Man Twist," a unique torsion Damascus (160 layers). The handle material is contoured G-10, and the titanium frame and clip are satin finished, adding to the stunning appearance. Titanium frame lock. Includes collector's box and certificate of authenticity. Blade length: 3¾". Overall length: 7¾". Weight: 3.7 oz. Item No. 110617DAM \$ 825.00

5 BOKER MERLIN DAMASCUS. The Merlin pocketknife inspired our Damascus forger to present an elegant yet uncluttered and fascinating

design. A stainless Damascus blade (160 layers) forged by Chad Nichols makes this gentleman's folding knife a collector's dream. The "Ladder" pattern draws very fine contrasts and harmonizes perfectly with the appearance of the Grenadill wood insets and stainless steel body. Does not have a pocket clip. Comes with a high quality collector's box and certificate of authenticity. Blade length: 2½". Overall length: 6¾". Weight: 2.9 oz. Item No. 110621DAM \$ 619.00

6 BOKER MERLIN. The Solingen knife maker Wilfried Gorski, a member of the German Knifemaker's Guild, not only impressed us with his technical and elegant designs, but also with his engineering ingenuity. We are

delighted to present Merlin, a typical Gorski design. Most interesting is his patented interlock system, which provides a simple and effective means of disengaging the blade. The high polished stainless steel handles are complemented with an attractive rosewood inset. To set this gem off, we have selected the premium steel N690B0, topped off with a satin finish. This gentleman's knife provides the best to the collector, user, or tech savvy individual. Does not have a pocket clip. Blade length: 2½". Overall length: 6¾". Weight: 2.9 oz. Item No. 110621 \$ 329.00



BOKER
MANUFACTORY SOLINGEN

Treasured Discoveries.



1
Boker Mammut I.
\$ 619.00

HANDLES MADE
OF GENUINE
MAMMOTH TOOTH



2
Boker Mammut II.
\$ 495.00

BOKER MAMMUT. Roughly four million years ago, large herds of mammoths inhabited parts of our prehistoric earth. It was about four thousand years ago these gigantic creatures became extinct. In recent times, fully preserved mammoths were discovered in the frozen fields of Siberia. Some challenging tests proved that the teeth of the mammoth provided a truly unique structure - an artistic appearance unlike anything else. The intricate handwork required and sheer age of these handle scales make for an extremely valuable collectors knife to add to your collection. Available in two popular patterns, each with a certificate of authenticity.

1 BOKER MAMMUT I. This classic folder features a 440C stainless steel blade and sturdy lockback mechanism. Blade length: 3 1/8". Overall length: 6 7/8". Weight: 4.3 oz. Item No. 110146 \$ 619.00

2 BOKER MAMMUT II. This gentleman's knife features a 4034 stainless steel blade and sturdy lockback mechanism. Blade length: 2". Overall length: 4 1/2". Weight: 1.5 oz. Item No. 111009 \$ 495.00

BOKER DINO. Antiquity is something that seems to fascinate everyone. Americans are in awe of relics from the colonial days. Europeans remain in awe of their ancient castles and the Roman ruins. The Boker Dinosaur Collectible gives you the opportunity to own and treasure something a bit older. Actually, a lot older - 130 million years old!

The handle scales of these collectibles are actually a section of petrified bone from a Sauropod, immense creatures with elephant-size feet and long necks and tails - commonly known as the Brontosaurus. During the Age of

the Dinosaurs, these creatures roamed the Mesozoic Southwest. These particular fossils were discovered in the Four Corners region of northwestern New Mexico. For unknown reasons, some of these specimens were quickly covered by mud and sand after death, causing them to become fossilized, or transformed into rock. The bone marrow in the cell cavities was replaced by fine particles, which then agatized to form the extremely unique coloring pattern that you see in the handle. A very limited amount of this bone is available for our use. Please accept it as a tangible reminder of the mysterious creatures that ruled the world at the dawn of time. Available in four models:

3 BOKER DINO DAMASCUS I. The traditional art of forging has existed for thousands of years (the blink of an eye in this context!). This exquisite

piece features an elaborately forged Damascus blade and sturdy lockback mechanism. Blade length: 3 1/8". Overall length: 7 1/4". Weight: 5.7 oz. Item No. 112028DAM \$ 1,075.00

4 BOKER DINO DAMASCUS II. The traditional art of forging has existed for thousands of years (the blink of an eye in this context!). This compact gentleman's knife features an elaborately forged Damascus blade and sturdy lockback mechanism. Blade length: 2". Overall length: 4 1/2". Weight: 1.7 oz. Item No. 111002DAM \$ 569.00

5 BOKER DINO I. This exclusive model features a 440C stainless steel blade and sturdy lockback mechanism. Blade length: 3 1/8". Overall length: 7 1/4". Weight: 5.7 oz. Item No. 112028 \$ 839.00

6 BOKER DINO II. This compact gentleman's knife features a 4034 stainless steel blade and sturdy lockback mechanism. Blade length: 2". Overall length: 4 1/2". Weight: 1.7 oz. Item No. 111002 \$ 419.00

3
Boker Dino
Damascus I.
\$ 1,075.00



4
Boker Dino
Damascus II.
\$ 569.00



HANDLES MADE
OF GENUINE
DINOSAUR BONES

5
Boker Dino I.
\$ 839.00



6
Boker Dino II.
\$ 419.00



A Sauropod/Brontosaurus bone. Only the best pieces are used for the scales on the Dinosaur Collectible knives.



BÖKER
MANUFATUR SOLINGEN

NEW

1
Boker Medallion
Titan.
\$ 59.95



NEW

2
Boker Medallion
Pearl.
\$ 104.95



NEW

3
Boker Medallion
Cocobolo.
\$ 64.95



4
Boker Damascus
Medallion.
\$ 154.95



BOKER MEDALLION. Due to the overwhelming success of our Damascus Medallion (model 111059DAM), we decided to expand on this concept. We are proud to present three new medallions, each with its own look. Whether it's modern, classic or elegant - you're sure to find your style.

1 BOKER MEDALLION TITAN. This piece is both modern and technical, with its mirror polished 4034 stainless steel blade and matte finish titanium handle. Easy to carry and virtually weightless! Blade length: 1 1/4". Overall length: 2 7/8". Weight: 0.4 oz. Item No. 111060 \$ 59.95

2 BOKER MEDALLION PEARL. Mother-of-Pearl - an incomparable material, which has been used for thousands of years for jewelry and decor. This unique medallion features a mirror polished 4034 stainless steel blade and a gleaming pearl handle. Classic and elegant! Blade length: 1 1/4". Overall length: 2 7/8". Weight: 0.4 oz. Item No. 111061 \$ 104.95

3 BOKER MEDALLION COCOBOLO. Cocobolo is a traditional wood for handle scales on hunting and pocket knives. The hardness and the handsome reddish-brown tones give this medallion a traditional appearance, and characterizes its owner as a true knife aficionado! The blade is mirror polished 4034 stainless steel. Blade length: 1 1/4". Overall length: 2 7/8". Weight: 0.4 oz. Item No. 111062 \$ 64.95

4 BOKER DAMASCUS MEDALLION. Damascus meets Bonsai! Like the famous Japanese miniature trees that grow in laborious and extensive care to small works of art, so does our Damascus offering. Although greatly reduced, it remains a thoroughly original and elaborate miniature version of a Damascus pocket knife. The blade and scales are made entirely of stainless Damascus, so that the term "gem" can be taken quite literally. With a total thickness of 1/4" and a closed length of 1 3/4", this piece can be worn as a pendant on a necklace. Handmade in the Boker factory in Solingen. Blade length: 1 1/4". Overall length: 2 7/8". Weight: 0.5 oz. Item No. 111059DAM \$ 154.95

Damascus steel blades are hand-forged in the painstaking tradition perfected over 2,000 years ago. It is a process that reaches perfection in the talented hands of BOKER's master craftsman, whose keen eye and sharp skill give birth to blades of exquisite metallic artistry, each composed of steel hundreds of layers thick, each as unique as a fingerprint. An attractive presentation box is included.

5 BOKER DAMASCUS AFRICAN THUYA. The 2" drop point blade is a work of art, consisting of 300 separate layers of Damascus steel. Handles are African thuya wood. Closed length: 2 1/2". Weight: 1.3 oz. Item No. 111004DAM \$ 249.00

6 BOKER DAMASCUS AMBOINA. This hunter style lock blade Damascus piece has luxurious Amboina wood handles. The 3 1/8" blade is made of hand-forged 300-layer Damascus steel. Closed length: 4 1/8". Weight: 5.9 oz. Item No. 112022DAM \$ 409.00

7 BOKER DAMASCUS AFRICAN EBONY. A unique collectible knife for those who appreciate the best in

cutlery. This lock blade hunter features handsome African ebony handles polished to a lustrous sheen. The 3 1/8" blade of 300-layer Damascus steel is crafted in the time-honored process, completely hand-forged. A masterpiece! Closed length: 4 1/8". Weight: 5.9 oz. Item No. 112023DAM \$ 379.00

8 BOKER DAMASCUS STAG. In the midst of our exclusive Damascus knives, stag horn definitely deserves a place! In response to numerous customer requests, we bring you this new classic. The hand-forged Damascus blade, complemented by the genuine stag handle, is sure to make this a sought-after collector's piece. Blade length: 3 1/8". Closed length: 4 1/8". Weight: 5.7 oz. Item No. 112016DAM \$ 469.00

9 BOKER DAMASCUS OAK. Collectors who know Boker quality will appreciate this special Damascus lock back. The 3 1/8" Damascus steel blade (300 layers) is hand-forged while the handles are crafted of 3,000-year-old oak. Overall open length: 7 3/8". Weight: 4.4 oz. Item No. 110100DAM \$ 389.00



5
Boker Damascus
African Thuya.
\$ 249.00



6
Boker Damascus
Amboina.
\$ 409.00



7
Boker Damascus
African Ebony.
\$ 379.00



8
Boker Damascus
Stag.
\$ 469.00



9
Boker Damascus
Oak.
\$ 389.00



BÖKER
MANUFATUR SOLINGEN

For the collector.

NEW

1
Boker
Eurofighter
Damascus Bottle
Opener.
\$ 64.95

Production
Prototype
Picture

2
Boker Leopard
Damascus I.
\$ 619.00

3
Boker Leopard
Damascus II.
\$ 619.00



The Tirpitz, the largest battleship of the German Navy.

4
Boker Tirpitz
Damascus.
\$ 889.00

ORIGINAL TIRPITZ Steel.
An original piece of the famous
Tirpitz steel, retrieved by
Norwegian divers
exclusively for Boker.

1 BOKER EUROFIGHTER DAMASCUS BOTTLE OPENER. This elegant new bottle opener, made of hand forged Damascus, allows you to open your bottles with superior style! The drilled hole in the handle allows you to keep it close at hand - attach it to your keychain or gear. Overall length: 5 1/8". Weight: 1.3 oz. Item No. 150001 \$ 64.95

2 BOKER LEOPARD DAMASCUS I. The Leopard Damascus is forged out of the German battle tank Leopard I. This specialty steel is not available to the market because it was only used for the military. Our Damascus forger was fortunate to acquire some for Boker exclusively. A chromium-manganese and vanadium tool steel alloy was added to this extremely wear-resistant barrel steel. The result is a remarkably high hardness

for Damascus steel (60-61° HRC). The pattern provided on the 300-layer blade is labeled "Small Pyramid." Handle material is 6061-T6 aluminum and features Ziracote wood inlays. Includes certificate of authenticity and gift box. Serialized. Blade length: 3 3/8". Overall length: 7 3/8". Weight: 4.4 oz. Item No. 110084DAM \$ 619.00

3 BOKER LEOPARD DAMASCUS II. The successor of our first knife with a Damascus blade forged out of the barrel of the German battle tank Leopard I. The edge holding ability is much higher compared to what other steel can achieve. A hardness of 60-61° HRC gives you an indication what to expect. Our forger's capabilities are proven by his Damascus pattern: "Large Pyramid." Handle material is hardcoated 6061-T6 aluminum with Ziracote wood inserts.

The clip can be switched for tip-up or tip-down carry. The knife includes a certificate of authenticity and a wooden presentation box. Blade length: 3 3/4". Overall length: 8 1/8". Weight: 5.5 oz. Item No. 111054DAM \$ 619.00

4 BOKER TIRPITZ DAMASCUS. A piece of history comes alive. The Tirpitz, sister ship of the legendary Bismarck, was the largest battleship ever built for the German Navy. On November 12, 1944, the British Royal Air Force attacked the Tirpitz with special tallboy bombs, settling it near the shore in the shallow water. Shortly after the war, a Norwegian specialty company took interest in the specially alloyed steel of the Tirpitz, and retrieved parts of the special armor of the Tirpitz, from the Fjord. These pieces of living history are being exclusively

forged by our Damascus forger to an extraordinary Damascus steel with an exciting background. The pattern "Great Pyramids," with more than 300 layers, adorns the mighty 4" blade, and makes this piece the highlight of any collection. The combination of the Tirpitz steel and carbon tool steels also creates an extremely rugged Damascus steel, which has a hardness of 61° HRC, and can handle any cutting task with ease. The handle, made of high strength AlMgSi1 aluminum (with Silicium, making it a much higher quality than standard AlMg3), is hardcoat anodized and provides a firm and secure grip. The reversible clip allows for tip-up or tip-down carry. For the handle inlay we chose domestic walnut, which has a long history as shaft wood for German rifles due to its superior characteristics. This eye-catching inlay

THE ORIGINAL
LEOPARD DAMASCUS STEEL
IS EXCLUSIVELY AVAILABLE
ONLY FROM BOKER!

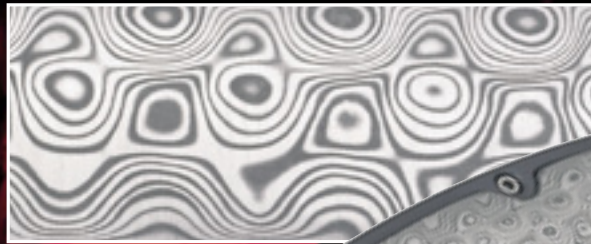

Inset made of stainless steel
Damascus (180 Layers)

5
Boker Leopard
Damascus
Collector.
\$ 825.00

6
Boker Leopard
Damascus III.
\$ 719.00

7
Boker Leopard
Damascus III 42.
\$ 719.00

SLIP JOINT DESIGN

also features the original Tirpitz crest. This knife combines history, tradition and modern technology in a more than unique way, and is handmade in the Boker manufacturing facility in Solingen, Germany. Comes complete in a wooden presentation box with a certificate of authenticity, and is serial numbered. Overall length: 9". Blade length: 3 7/8". Liner thickness: 1/16". Weight: 5.9 oz.
Item No. 110190DAM \$ 889.00

5 BOKER LEOPARD DAMASCUS COLLECTOR. Leopard Damascus, the legendary blade steel from Boker, is embraced by knife enthusiasts

worldwide. The Damascus blades from the barrel of the battle tank Leopard, are truly a piece of jewelry in every knife collection. All three of the Leopard Damascus models offer precious wooden insets set into the CNC milled, hardcoat anodized aircraft aluminum handles. The Leopard Damascus collection model is once again refined with inlays made of corrosion-free Damascus steel (180 layers), which is artistically set into the handle by hand. This knife boasts a completely new appearance with its powder Damascus insets, which harmonize perfectly with the hand forged 300-layer Damascus. This piece is a must-have for the expert of Leopard Damascus knives. This

collectors knife is serial numbered and strictly limited to 999 pieces worldwide. Includes reversible pocket clip for tip-up or tip-down carry. Comes in a wooden presentation box with a certificate of authenticity. Blade length: 3 7/8". Overall length: 8 7/8". Weight: 5.9 oz.
Item No. 110139DAM \$ 825.00

6 BOKER LEOPARD DAMASCUS III. The third generation of the high performance Damascus steel forged out of the barrel of the German battle tank Leopard I. For the first time our Damascus forger welds two more steels with the battle tank steel. The extremely hard to treat material is welded with over 300 layers to create these unique blades. The result is a hardness of 60-61° HRC and superior cutting capabilities.

The handle is made of CNC machined AlMgSi1 aluminum and is hardcoat-anodized, contrasting nicely with the Grenadill wood insets. The clip can be reversed for tip-up or tip-down carry. Comes gift boxed with a certificate of authenticity. Blade length: 3 7/8". Overall length: 8 7/8". Weight: 5.5 oz.
Item No. 110130DAM \$ 719.00

7 BOKER LEOPARD DAMASCUS III 42. All the same impressive features as model 110130DAM (above), but in a slip joint version, with nail nick (no flipper). Blade length: 3 7/8". Overall length: 8 7/8". Weight: 5.5 oz.
Item No. 110129DAM \$ 719.00



BÖKER
MANUFACTORY SOLINGEN

1
Boker Damascus
Ivory Micarta.
\$ 295.00



2
Boker Mokume
Damascus.
\$ 569.00



LIMITED EDITION

3
Boker Classic
Mokume.
\$ 649.00



NEW

LIMITED EDITION

4
Boker
Kalashnikov
Anniversary.
\$ 339.00



1947 ★ (65) ★ 2012

1 BOKER DAMASCUS IVORY MICARTA. The ivory Micarta handle scales make this elegant gentleman's knife a real eye-catcher! The Leopard Damascus blade, with its sleek lines, ensures high versatility in everyday tasks (for information on the exclusive Leopard Damascus, see page 12). Also features polished bolsters and nickel silver plates with Micarta scales, mounted on a black fiber underlay. Manufactured by hand in the Boker Manufactory in Solingen, Germany. A true classic for your pocket! Blade length: 2 3/8". Overall length: 5 1/2". Weight: 2 oz. Item No. 112125DAM \$ 295.00

2 BOKER MOKUME DAMASCUS. A stunning presentation for the collector! Two breathtaking materials from the Thomas Damascus forge, combined with the exotic Imbuia wood handle make this one a must. An extremely delicate forging process results in the 150 layer stainless "typhoon pattern" Damascus, displaying a very fine structure. The bolsters are made of traditional Japanese Mokume, a combination of different non-ferrous metals forged together in a very complex process resulting in a Damascus-like pattern of different colors. The selected Imbuia wood completes this pristine gem. A backlocking mechanism adds security. Comes in a wooden collectors box with a certificate of authenticity. Blade length: 3 1/8". Overall length: 7". Weight: 4.3 oz. Item No. 110144DAM \$ 569.00

3 BOKER CLASSIC MOKUME. This new version of our 2002 Series offers a breathtaking combination of materials. The nickel silver tang is capped with bolsters of Mokume, the traditionally manufactured Damascus-like material of non-ferrous and precious metals. This high quality material is then complemented by



5
Boker JTN.
\$ 309.00



6A
Boker Sheath.
\$ 51.95



6
Boker Damascus
Hunter.
\$ 475.00



7
Boker Minx.
\$ 309.00



polished brown canvas Micarta scales on red fiber inlays. The blade, made of traditionally forged 300-layer Damascus, completes this stunning piece. An incomparable knife, which will be a true eye-catcher in your showcase. Strictly limited to 199 pieces worldwide. Comes in a wooden presentation box with a certificate of authenticity. Blade length: 3 7/8". Overall length: 7". Weight: 4.3 oz. Item No. 112101DAM \$ 649.00

4 BOKER KALASHNIKOV ANNIVERSARY. The technical pioneering spirit of General Kalashnikov and his masterpiece, the construction of the world famous and probably most common assault rifle, the Automat Kalashnikov 47, shows itself in the 65th Anniversary of the legendary weapon. As the official manufacturer of Kalashnikov knives, we honor the success of General Kalashnikov, and dedicate this limited edition to this special occasion. The black anodized aluminum handle features stainless Damascus inlays, and the 440C stainless steel blade boasts a mirror finish and special anniversary logo. Includes pocket clip. Strictly limited to just 199

pieces worldwide. Each piece comes serial numbered, with a certificate. Blade length: 4". Overall length: 9". Weight: 6 oz. Item No. 11KAL47A \$339.00

5 BOKER JTN. The original idea for the JTN (Join the Navy) is based on old Navy survival knives from the time of World War II. This design, by Jesper Voxnaes, translates the compact, sturdy and practical characteristics into a more contemporary approach. The bellied handle scales of the full tang construction consist of green canvas Micarta and are mounted on yellow liners. The special shaping provides excellent ergonomics for any range of application, and the handle end has been designed as a hammer. The chosen blade material is N690BO steel, which has proven its worth and performance in a multitude of other knives in our lineup. Includes a high quality leather sheath. Blade length: 4 1/4". Overall length: 9". Weight: 7.7 oz. Item No. 120635 \$ 309.00

6 BOKER DAMASCUS HUNTER. Hunting knife with 180 layers of stainless Damascus. Our Swedish supplier called this particular knife pattern "Odin's eye." According to the Nordic legend, nothing can be hidden before the eye of Odin. Solid nickel silver cross guard and pommel guarantee a very solid construction. The blade is fastened by a screw at the end of the cap. The handle is made of Ziracote wood from Belize – a firmly structured, water repellent wood. Includes wooden gift box and certificate of authenticity. Overall length: 7 3/8". Weight: 3.4 oz. Item No. 120588DAM \$ 475.00

6A BOKER SHEATH. High quality saddle leather sheath, for item 120588DAM (above), available upon special request. Item No. 129988 \$ 51.95

7 BOKER MINX. With Neil Blackwood, our international Boker design team has a very prominent member. His knives amaze with a most unique and distinctive design, resulting in perfect ergonomics and high versatility. The flowing design lines make his knives most appealing and sought after collector pieces. We are proud to present this design in our production lineup. As blade steel, we chose high performance S35VN steel. The sturdy full tang blade with the recurve edge covers a wide variety of applications, from EDC use to hunting and processing game. The deep index finger choil and the thumb notches offer maximum control regardless of the conditions. Handle scales are made of stabilized beech wood. Includes a high quality leather sheath. Blade length: 2 5/8". Overall length: 6 1/4". Weight: 3.5 oz. Item No. 120617 \$ 309.00



BÖKER
MANUFATUR SOLINGEN

1
Boker Bowie.
\$ 379.00



1 BOKER BOWIE. This massive 7³/₄" 4034 stainless steel blade is 1/4" thick and features a full tang. Beautiful European walnut handle with lanyard hole meets an "S" style brass guard. Made in Solingen. Includes Western-style leather sheath. Overall length: 12³/₈". Weight: 17.5 oz. Item No. 120547 \$ 379.00

2
Boker Trench
Dagger Letter
Opener.
\$ 144.95

2 BOKER TRENCH DAGGER LETTER OPENER. The success of our Trench Knife has inspired us to present an everyday function for this piece. In a scaled down version to two thirds of the original size, it now also adorns your desk as a letter opener. Nevertheless, this piece of history makes an interesting addition to any collection of knives or military history. The blade is 4034 stainless steel, and the scales are made of handsome walnut. Made in the Boker knife manufactory in Solingen, Germany. Blade length: 3⁷/₈". Overall length: 6³/₄". Weight: 1.5 oz. Item No. 140918 \$ 144.95

3 BOKER TRENCH KNIFE. It was 1915 when Heinrich Boker & Co. Solingen received the government order to develop a compact fighting knife that would be especially useful for trench warfare. After 90 years, we are

reproducing the original knife blade out of high carbon steel with 0.75% carbon. The pronounced steel crossguard, the wood forearm handle, (designed for a firm and safe grip), and the official tang stamp are identical to the original – as is the cowhide leather sheath. On the back of the blade, each knife shows its serial number. Blade length: 5⁵/₈". Overall length: 10". Weight: 5.9 oz. Item No. 121918 \$ 196.95

3
Boker Trench
Knife.
\$ 196.95



4 BOKER SWISS DAGGER TWISTED DAMASCUS. Following the tradition of the European Damascus sword smithing art of the Middle Ages, the Boker manufacturing plant in Solingen, Germany is proud to present the Swiss Dagger in an exclusive collector's edition. Four bands/strips of twisted Damascus, consisting of a nickel and manganese tool steel, are forged into a breathtaking blade featuring flawless

symmetry and beauty, which requires a tedious smithing process. Each strip is made of a single Damascus packet, which is first forged by hand and then twisted 15 times. Four of these twisted packets are fire welded and then forged into this historical blade shape. The structure that is achieved with these different layers guarantees not only legendary strength, it also creates a highly unique pattern, which defines "Twisted Damascus." Blades made of twisted Damascus represented the highest class of smithing art in the Middle Ages, and therefore was only available to the people of nobility. This historical and very complex forging process, which can be accomplished by very few Damascus forgers, is now in the hands of Andreas Henrichs, who is performing this great art perfectly and exclusively for Boker. The discreet glimmer of the black, hand selected ebony wood used for the handle builds a perfect unity with the high polished stainless steel handguard and pommel. The sheath for this masterpiece has been custom designed and sewn by hand, underlining its exclusivity. This model is strictly limited to just 500 pieces worldwide, all serial numbered. Presented in a wooden gift box with a certificate of authenticity. Blade length: 8⁵/₈". Overall length: 14¹/₈". Weight: 9.1 oz. Item No. 121551DAM \$ 2,575.00

5 BOKER SWISS DAGGER. The Swiss dagger (often called "Baselard") was a popular weapon with the Swiss pikemen throughout the 15th and 16th centuries. Swiss daggers were not usually issued as ordinance weapons, but purchased privately by soldiers as secondary weapons. The Boker Swiss dagger's characteristic hilt features the same crescent-shaped pommel and crossguard as the original daggers, but now feature rust resistant stainless steel instead of iron. Their curved shape appeared as early as the 13th century and remained unique to Switzerland. This distinctive hilt design can be recognized in many of Hans Holbein's works, which is why the Swiss dagger was sometimes referred to as a "Holbein dagger." The handle on the Boker Swiss dagger is made of hand selected cherry wood, and the high carbon steel dagger style blade has an impressive length of 8⁵/₈" and is satin finished. The blade is marked with the authentic Boker logo, which was used throughout the 1930's in Solingen. The marking "Deutschland" (Germany) and a serial number on the reverse side of the blade guarantee the same high quality on every knife that leaves our factory. The Swiss dagger includes an original metal sheath, which is reminiscent of the 15th and 16th centuries. Overall length: 14¹/₈". Weight: 9.1 oz. Item No. 121550 \$ 369.00



4
Boker Swiss
Dagger Twisted
Damascus.
\$ 2,575.00

5
Boker Swiss
Dagger.
\$ 369.00



Metal Sheath, based on historic models.



Authentic Blade
Marking from the
1930's.



BÖKER
MANUFATUR SOLINGEN

Simply put... outstanding.



7mm blade thickness

1
Boker Pry-Mate.
\$ 309.00



BÖHLER
N690B0



5mm blade thickness

2
Boker Pry-Mini.
\$ 249.00



1 BOKER PRY-MATE. The name says it all. With the unbelievable blade thickness of nearly 7mm, this knife knows no limits. With an overall length of 6½" and a blade length of 3¾", this knife is truly built like a tank. The Danish knifemaker, Jesper Voxnaes, with his label VoxKnives, has provided us with this virtually indestructible piece. The milled Micarta scales and the deep thumb notches provide an extremely secure grip for any kind of task, and the red fiber liner offers an attractive contrast to the mighty blade

spine. The hollow grind guarantees excellent cutting performance, which you would not ordinarily expect from a blade with dimensions like this. The N690B0 blade steel is satin finished and provides high corrosion resistance and edge retention. The hand fitted Kydex sheath offers multiple carry options and is Tek-Lok compatible (Tek-Lok not included). An extreme knife for any situation, that is sure to impress! Weight: 6.3 oz. Item No. 120614

\$ 309.00

2 BOKER PRY-MINI. The little brother of the Pry-Mate by VoxKnives. The 5mm blade thickness makes this piece a rugged and handy companion for any task. The well balanced handle design with deep thumb notches offers a secure and comfortable grip. The ultra compact dimensions even allow for comfortable carry in the pocket. The Tek-Lok compatible Kydex sheath can also be mounted on a belt or on your equipment in various positions (Tek-Lok not included). The blade is made of N690B0 steel, which provides superior corrosion resistance and edge retention. Blade length: 2½". Overall length: 5¼". Weight: 3 oz. Item No. 120615

\$ 249.00

Orca Outdoor Gen 2. The full tang construction, now made of N690B0 steel, provides incredible strength and chopping abilities. The three dimensional contoured handle scales made of blasted green canvas Micarta provide outstanding ergonomics and a very secure grip, even under wet or cold conditions. If one prefers a flat design, the handle scales can be detached, for a look and feel more like the old Beluga model. The U.S. made sheath by Spec-Ops completes this rugged package. Blade length: 5¼". Overall length: 10½". Weight: 12 oz. Item No. 120595

\$ 389.00

3 BOKER ORCA OUTDOOR GEN 2. After many requests for the return of our famous Orca and Beluga, we decided to combine the best features of these two models and create the new

4 BOKER ORCA OUTDOOR GEN 2 PLAIN. Same features and specifications as the original, model 120595, but with a plain edge blade. Blade length: 5¼". Overall length: 10½". Weight: 12 oz. Item No. 120596

\$ 379.00

4
Boker Orca
Outdoor Gen 2
Plain.
\$ 379.00



3
Boker Orca
Outdoor Gen 2.
\$ 389.00

NEW

5
Boker Solo.
\$ 209.00



Production
Prototype
Picture

6
Boker Cox.
\$ 259.00



7
Boker
Haddock.
\$ 289.00



8
Boker Anso 67.
\$ 289.00



5 BOKER SOLO. An exciting new design from Jens Ansø. This folder is designed as a large EDC knife or an all purpose tactical knife. The sturdy scales are CNC machined aluminum, hardcoat anodized. Due to the specially designed texturing, the handles provide a full, secure grip. The blade locks securely with the sturdy steel liner, and is crafted of high performance N690BO stainless steel. Includes a reversible pocket clip for tip-up or tip-down carry. Blade length: 3¾". Overall length: 8⅝". Weight: 6.1 oz. Item No. 110633 \$ 209.00

6 BOKER COX. The overwhelming success of the Haddock (model 110617) prompted designer Jens Ansø to provide a little brother. The difference is not only in size, but the Cox model is a slip joint design, with the blade held open by the tension of the backspring, just like a traditional pocket knife. The clip can be mounted for tip up or tip down carry. The blade steel is N690BO, for its superior edge holding capabilities. The 4mm hollow ground blade unites cutting ability

with outstanding strength. Blade length: 2¾". Overall length: 6⅞". Weight: 4 oz. Item No. 110618 \$ 259.00

7 BOKER HADDOCK. A new member of the international Boker design team is Jens Ansø from Denmark. We are proud to offer this modern piece which features, with its massive dimensions and two-way clip, all the criteria of a true pocket knife and is sure to inspire the ambitious user and collector. The upper scale is made of contoured, CNC machined G-10, and the back liner consists of 3mm of solid titanium. This

construction allows for an excellent feel and grip, and keeps it lightweight. The exotic shaped blade is made of cobalt N690BO steel, is 5mm thick, and features a precise hollow grind that is razor sharp and perfectly balanced. The classic nail nick makes opening easy, and the stonewashed finish on the blade and framelock provides an attractive contrast to the handle. Blade length: 3⅜". Overall length: 7⅝". Weight: 4 oz. Item No. 110617 \$ 289.00

8 BOKER ANSO 67. With the model "67," Jens Ansø presents another successful frame lock design, manufactured by Boker. The layout is similar to the "Haddock," with a

3mm thick titanium liner and a front G-10 scale. The removable thumb stud and the reversible clip (tip-up/ tip-down) make this exclusive design complete, combining ruggedness and a simple construction with a unique and expressive design. The blade is made of high quality N690BO steel. Blade length: 3½". Overall length: 7⅝". Weight: 4.5 oz. Item No. 110620 \$ 289.00



BOKER
MANUFATUR SOLINGEN



1
Boker Turbine.
\$ 279.00

2
Boker Turbine 42.
\$ 279.00

3
Boker Turbine II.
\$ 249.00

4
Boker Turbine II 42.
\$ 249.00

1 BOKER TURBINE. For this model, we chose the name TURBINE, which stands for power and tough reliability. A knife that fulfills the tactical demand without being menacing. The specially milled rosewood inset adds an important contribution. The 4mm thick blade, made of X-15 T.N. steel, locks open with a 1.5mm liner lock that is rock solid. Precise CNC machined AlMgSi1 handle. The finger grooves provide a secure, comfortable grip, and the distinctive handguard at the end of the blade allows for safe handling, as well as fast opening action for the experienced user. The pocket clip allows tip-up or tip-down carry for added convenience. Overall length: 8⁷/₈". Blade length: 3⁷/₈". Weight: 5.5 oz. Item No. 110130 \$ 279.00

2 BOKER TURBINE 42. The two-hand opening version of our successful TURBINE model. The 4mm thick blade, made of Cronidur 30 premium stainless steel, locks open with a 1.5mm liner lock that is rock solid. The precise CNC machined AlMgSi1 handle has finger grooves for a comfortable and secure grip. The pocket clip allows tip-up or tip-down carry for added convenience. Blade length: 3⁷/₈". Overall length: 8⁷/₈". Weight: 5.5 oz. Item No. 110129 \$ 279.00

3 BOKER TURBINE II. The scaled down version of the original Turbine (item 110130), featuring a bead blasted spearpoint blade and olive hardcoat anodized handle. Blade length: 3". Overall length: 7". Weight: 3 oz. Item No. 110131 \$ 249.00

4 BOKER TURBINE II 42. A traditional version of the popular Turbine II, featuring a two-hand operation with nail nick. The blade steel is high performance X-15 stainless. CNC machined aluminum (AlMg3) handles with Palisander wood inlays and a sturdy liner locking mechanism. Blade length: 3". Overall length: 7". Weight: 3 oz. Item No. 110127 \$ 249.00

5 BOKER JIM BURKE THORN. This titanium version of our 2011 Damascus Collectors Knife (below) explodes with beauty and is characterized by classic elegance. The perfection of this design by Jim Burke is evident when comparing the two - each exudes its own

personality. The flat titanium scales are contoured and blend to a stable frame lock. The blade steel is powder metallurgy CPM-154, used by Burke in most of his own custom creations. The matte finish of the handles and blade create a stunning beauty from the Solingen factory. Blade length: 2⁵/₈". Overall length: 6¹/₄". Weight: 3 oz. Item No. 1132011 \$ 339.00

6 BOKER BLACKWOOD PIPSQUEAK. Within our custom collaborations, we are proud to present the first Boker folding knife by Neil Blackwood. The Pipsqueak successfully resists being classified into a particular category. Depending on the point of view, it is either the "smallest big knife" or the "biggest small knife" that we know of. The width of the blade and the handle, as well as the thickness of the material, are characteristic of a tactical folder, whereas the overall length and the proportions of the knife fit into the category of small and compact knives. The solid titanium frame is capped with a green canvas Micarta scale, and the back side forms an extremely sturdy frame lock mechanism. The spacer in the handle is

also made of Micarta, and protrudes like a dorsal fin at the tip of the handle. The beautiful line of the blade is emphasized by the striking two-tone finish. For this masterpiece, we chose the high performance steel S35VN. As an extra feature, the clip reflects the overall outline of this impressive piece. The ultimate knife, based on the design of a legendary knifemaker, which will inspire both the collector and the user. Blade length: 2⁵/₈". Overall length: 6¹/₄". Weight: 4.7 oz. Item No. 110623 \$ 309.00

7 BOKER OBERLAND ARMS EDW. Oberland Arms is a German manufacturer of high quality sporting and tactical weapons of type AR-15, which are characterized by their high precision, and whose objective is to offer only the highest quality. This premise strongly coincides with our philosophy, therefore we suggested a joint venture. We closely collaborated in creating a concept that represents the essence of a tactical knife. The massive titanium plates, with a thickness of 2.5mm, provide outstanding stability. The contoured canvas Micarta handle scales provide excellent grip, even in wet conditions, and feature a drilled center groove which enhances the grip and safety. The RST (Reinforced



5
Boker Jim
Burke Thorn.
\$ 339.00



Spearpoint Tip) offers incomparable stability, due to its special geometry, and underlines the sturdy design of the knife. The resistant stonewash finish of the N690BO blade completes the package. The reversible pocket clip can be adjusted according to the thickness of the pocket hem. This bulky yet compact knife is a reliable, multifunctional tool for any cutting task, whether it be for work or everyday use. Blade length: 3³/₈". Overall length: 7⁷/₈". Weight: 5.1 oz. Item No. 110626 \$ 349.00

6
Boker
Pipsqueak.
\$ 309.00



7
Boker Oberland
Arms EDW.
\$ 349.00

Oberland Arms

8 BOKER TITAN DEFENDER. A professional tactical folder for the highest of demands. Designed by Armin Stütz from Steirer Eisen, Austria, this piece features a massive integrated liner lock made completely of titanium. The lock bar is CNC-milled directly out of the handle slab and is made of Grade 5 Titanium, 2mm thick. This lock will stand up to any operational demands! The bolsters are also made of CNC-milled titanium, for weight reduction. The CNC-milled blade is made of exclusive N690BO steel, which is a high performance special alloy containing cobalt, that was created in cooperation between Böhler and Boker. Even the G-10 handle scales are CNC-milled with an even finish, which provides for a very safe and firm grip. Also features a handy glass-breaker for emergency situations and the newly designed, polished Boker clip for comfortable and convenient carry. Blade thickness: 4mm. Blade length: 3³/₈". Overall length: 8". Weight: 5.9 oz. Item No. 110930 \$ 555.00



8
Boker Titan
Defender.
\$ 555.00



Exclusive Boker Clip

9 BOKER TITAN DEFENDER LIGHTWEIGHT. The lightweight version of our Titan Defender. The use of green canvas Micarta for the full length handle scales reduces the weight and provides a super secure grip, even under extreme conditions. The massive titanium liners guarantee an extraordinary stability to this rugged knife. The stonewash finished blade is made of N690BO steel. Also features a pocket clip and glass-breaker tip for emergency situations. Blade thickness: 4mm. Blade length: 3³/₈". Overall length: 8". Weight: 5.3 oz. Item No. 110931 \$ 349.00



9
Boker Titan Defender
Lightweight.
\$ 349.00



Innovative Excellence.

1
Boker Turbine
Forum.
\$ 299.00



1 BOKER TURBINE FORUM. This model was created due to high demand from the German Internet Bladeforums. We were asked for a version of the Turbine with both the versatility of the tactical model handle (with its glass-breaker and G-10 high grip inlay), and the bead blasted spearpoint blade. Now we are proud to present this model to satisfy the needs of our customers. Same specifications as the 110130 (shown on page 20). Overall length: 8⁷/₈". Blade length: 3⁷/₈". Weight: 5.5 oz. Item No. 110132 \$ 299.00

GLOW
in the
DARK

2
Boker
Illumination
Top Lock.
\$ 185.95



2 BOKER ILLUMINATION TOP LOCK. Our famous Top Lock model gets a new look! The unique contrast of the glow-coated aluminum scales and the dramatic black inlays and blade create an exciting effect. Blade steel is 4034 stainless. Handmade by Boker in Solingen, Germany. Non-automatic. A knife that won't be overlooked, even in the dark! Includes Cordura sheath. Blade length: 3¹/₄". Overall length: 7⁷/₈". Weight: 4 oz. Item No. 110018 \$ 185.95

NON-AUTOMATIC

3
Boker Law
Enforcement Top
Lock II.
\$ 93.95



3 BOKER LAW ENFORCEMENT TOP LOCK II. Our famous Top Lock II (non-automatic), featuring black coated aluminum handle and black coated, plain edge blade of Solingen 4034 stainless steel. Black Kraton insets. Includes Cordura sheath. Blade length: 2³/₄". Overall length: 6³/₄". Item No. 117109 \$ 93.95

4
Boker Top Lock
II Thuya.
\$ 93.95



4 BOKER TOP LOCK II THUYA. Our famous Top Lock II (non-automatic), featuring African thuya wood inset and plain edge blade, made of 4034 stainless steel. Includes Cordura sheath. Blade length: 2³/₄". Overall length: 6³/₄". Item No. 117103 \$ 93.95

5 BOKER GEMINI BADGER. This versatile knife can be easily opened and closed with one hand, and features a durable ABS handle with Kraton inset. The blade is rust-proof X-15 T.N. steel, partially serrated. Includes pocket clip for easy carry. Blade length: 3⁵/₈". Closed length: 4³/₄". Overall open length: 8¹/₈". Weight: 3.2 oz. Item No. 110090X \$ 111.95

6 BOKER GEMINI LAW ENFORCEMENT MODEL. This versatile knife can be easily opened and closed with one hand, and features a durable ABS handle with Kraton inset. The blade is black

5
Boker Gemini
Badger.
\$111.95



6
Boker
Gemini Law
Enforcement.
\$ 93.95



coated Solingen 4034 stainless steel, partially serrated. Includes pocket clip for easy carry. Blade length: 3 5/8". Closed length: 4 3/4". Overall open length: 8 1/8". Weight: 3.2 oz. Item No. 110090B \$ 93.95

7
Boker Escrima
Folding Dagger.
\$ 239.00



7 BOKER EFD – ESCRIMA FOLDING DAGGER. You would not believe that it is possible to improve on a knife which has been determined to be of the highest quality and functionality, but it is. This knife has been designed to be the ultimate when it comes to self defense. The integral notched blade guards provide 100% control and safety. The modified handle swell fits naturally in the hand. The black hardcoat anodized handle prevents scratching and slipping, and features a pocket clip for convenient carry. Blade material is 440C stainless steel. Knife pouch included. Overall length: 9 3/8". Blade length: 4". Weight: 6.3 oz. Item No. 112200 \$ 239.00

8
Boker
Kalashnikov BK.
\$ 309.00

8 BOKER KALASHNIKOV BK. A name that is synonymous with genius, strength and reliability and changing the face of modern warfare. Boker was proud to secure the exclusive rights from Mikhail Timofeevich Kalashnikov, the mastermind behind the famed Automat Kalashnikov 47 rifle, for this equally impressive knife. The contour and lines complement the style found in the original Automat Kalashnikov rifle. The finest CNC machine work is incorporated into the anodized 6061-T6 black coated aluminum handles with



handsome cocobolo wood inlays. The blade is made of 440C stainless steel with black PVD coating, and is reminiscent of the bayonet used with the Automat Kalashnikov 47 rifle. Blade length: 4". Overall length: 9". Weight: 6 oz. Item No. 11KAL47B \$ 309.00



Mikhail Timofeevich Kalashnikov



BOKER
MANUFACTUR SOLINGEN

A history of perfection.



1
Boker Todd Begg
Kiridashi.
\$ 144.95



2
Boker Todd Begg
Mach 2.
\$ 222.00

3
Boker Bender.
\$ 209.00

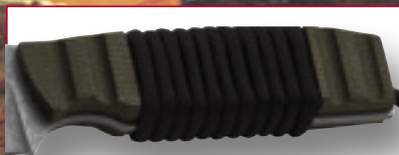

4
Green Micarta Handle Scales
(knife sold separately).
\$ 61.95

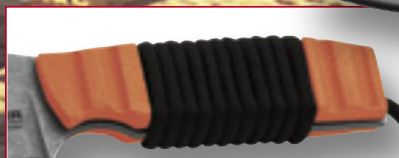

5
Orange Micarta Handle Scales
(knife sold separately).
\$ 82.95



3 BOKER BENDER. German knifemaker Steffen Bender developed an ingenious concept of interchangeable handle scales without the use of any tools. When attached to this stout, sturdy fixed blade, the scales are as secure as a bolted scale. A simple winding of the paracord through pre-set holes in the tang offers you the choice of a black Micarta (included), green canvas Micarta or orange Micarta handle (each sold separately). Modify the look with different color paracord if you like! The blade steel is 440C with a stonewash finish. Includes a Kydex sheath, Tek-Lok compatible (Tek-Lok not included). Blade length: 2¾". Overall length: 7". Weight: 3.5 oz. Item No. 120622 \$ 209.00

1 BOKER TODD BEGG KIRIDASHI. The traditional Japanese Kiridashi knife was originally made for carving or cutting little branches. Todd Begg's modern interpretation of this ancient concept provides tactical applications as well. The polished razor sharp chisel grind edge cuts like a beast and makes it a great utility or back-up knife. A curved handle (stonewash finished) with deep thumb notches provides a super secure grip under all circumstances. The Kydex sheath is suitable for neck carry, or a Tek-Lok (sold separately) can be

attached for belt/gear carry. Superior carrying comfort is achieved by the slim profile. Blade steel of this solid one-piece construction is 440C stainless. Manufactured in Solingen, Germany. Thickness: 3.7mm. Overall length: 5½". Cutting edge length: 1¾". Weight: 2 oz. Item No. 120608 \$ 144.95

2 BOKER TODD BEGG MACH 2. Todd Begg, knifemaker from Washington, sets up more thrilling collaborations with Boker. The Mach 2 is a slim yet very ergonomic fixed blade, typical of a Begg design. Just

grab it, and you'll be surprised how well the contoured handle, with its exclusive desert ironwood scales, fits in your hand. A thumb ramp with grooved notches provides a super secure grip. The spear point blade design provides great versatility, with a slightly recurved edge for very effective work, and a fine satin finish. The leather sheath comes with a clip for various carrying options. The 440C stainless blade steel offers superior edge retention. Manufactured in Solingen, Germany. Blade thickness: 3.8mm. Blade length: 3⅞". Overall length: 7¾". Weight: 3.2 oz. Item No. 120607 \$ 222.00

6
Boker Dozier.
\$ 379.00



7
Boker
Vollintegral
White Micarta.
\$ 415.00



8
Boker
Vollintegral.
\$ 415.00



4 BOKER GREEN CANVAS MICARTA SCALES. Green canvas Micarta handle scales only, for the Boker Bender, model 120622 (knife sold separately). Item No. 129010 \$ 61.95

5 BOKER ORANGE MICARTA SCALES. Orange Micarta handle scales only, for the Boker Bender, model 120622 (knife sold separately). Item No. 129020 \$ 82.95

6 BOKER DOZIER. You need to say no more. His name is synonymous with the classic American design pros. We are fortunate to team up with Bob Dozier to produce this impressive fixed blade that features a 3 3/8" blade of powder metallurgical CPM D2 steel. Handle material is handsome brown Micarta. Includes a high grade leather sheath. Overall length: 8 1/4". Weight: 6.2 oz. Item No. 120611 \$ 379.00

7 BOKER VOLLINTEGRAL WHITE MICARTA. An addition to the premium line of forged hunting knives, this model features striking white Micarta handles. The hollow ground blade is made of high performance 440C stainless steel. Includes a premium black leather sheath. Blade length: 4 3/4". Overall length: 9 1/2". Weight: 8.9 oz. Item No. 120585M \$ 415.00

8 BOKER VOLLINTEGRAL. Designed by U. Look of Germany for maximum strength. This fixed blade hunter has an integral guard and pommel, and the 4 5/8" drop point blade is hot-drop forged of 440C stainless steel. Handles are made of genuine stag.

Overall length: 9 1/2". Includes snapped sheath of light brown British saddle leather. Item No. 120585HH \$ 415.00

9 BOKER VOLLINTEGRAL MICARTA. This solid integral knife is sure to be a classic among premium hunting knives. Presented in a modern version featuring a handle crafted of fine wine Micarta in a dark burgundy tone. The blade is made of high performance 440C stainless steel. Comes complete with a premium black leather sheath. Blade length: 4 5/8". Overall length: 9 1/2". Weight: 9.1 oz. Item No. 120588 \$ 389.00

9
Boker
Vollintegral
Micarta.
\$ 389.00



BOKER
MANUFACTORY SOLINGEN

High class functionality.

1
Boker Solid.
\$ 349.00



2
Boker Solid
Forest.
\$ 279.00



3
Boker Terra
Africa II.
\$ 319.00



1 BOKER SOLID. A rugged and handy outdoor and hunting knife, designed by Swiss knifemaker and forger Thomas Künzi. The hollow ground blade is made of D2 steel and boasts an excellent edge-holding capability. The handle scales are made of carefully selected grained birchwood, and their generous dimensions are designed to provide a comfortable grip, even for extended use. The pommel of the full tang blade doubles as a punch or a hammer, and the notches on the blade spine allow extra control for precise cutting tasks. All in all, a more than "solid" concept which

combines many years of experience in knifemaking and outdoor activities with a very unique piece. Includes lanyard and high quality leather sheath. Blade thickness: 4mm. Blade length: 3 1/4". Overall length: 7 3/8". Weight: 4.2 oz. Item No. 120579 \$ 349.00

2 BOKER SOLID FOREST. The latest edition of the highly acclaimed hunting knife of Switzerland knifemaker Thomas Künzi. This model features green canvas Micarta scales, to fit the needs of not only the hunter, but for every outdoorsman. Even cold or wet hands find a comfortable and secure grip with this piece. The hollow ground

blade is crafted of D2 steel. Includes lanyard and premium black leather sheath. Blade thickness: 4mm. Blade length: 3 1/4". Overall length: 7 3/8". Weight: 4.2 oz. Item No. 120579M \$ 279.00

3 BOKER TERRA AFRICA II. An impressive looking yet extremely useful version of the original Terra Africa. The expressive grain of the Palmira wood handle scales contrasting with the two-toned N690BO steel blade make this a real standout for use or collection. The full tang construction and stainless steel bolsters provide maximum stability. High grade leather sheath included. Blade length: 4 1/4". Overall length: 8 5/8". Weight: 6.5 oz. Item No. 120623 \$ 319.00

4 BOKER GAME HUNTER. Boker knives – the sportsman's authority since 1869. This exciting knife design is intended for those who love hunting, fishing and the great outdoors. The construction of this knife boasts our very best. The flat ground 3 3/8" blade is made of premium high carbon C-75 steel that will hold an edge extremely well. The handle is an exotic African rosewood, called Bubinga, and is hand-shaped and finished, giving the knife its unique appearance and perfect contour. Also featuring a nickel silver guard and pommel. Includes a dark brown custom fitted leather sheath. Overall length: 7 3/8". Weight: 3.4 oz. Item No. 120587 \$ 196.95

5 BOKER AMICO. An elegant companion for every day. This handy three-finger-knife features a very slim

4
Boker Game Hunter.
\$ 196.95



5
Boker Amico.
\$ 249.00



6
Boker Integral Hunter Thuya.
\$ 289.00



7
Boker Savannah.
\$ 415.00



profile, for outstanding carry comfort. The canvas Micarta scales and deep finger choils combined with the notched thumb ramp provide a super secure and comfortable grip, even under wet conditions. This new carry concept allows discreet and practical carry. The handle features a pocket clip on the back side, just like a folding knife, or a Tek-Lok (not included) can be mounted on the sheath for multi-position belt carry. The full tang blade is made of premium N690B0 steel, which provides superior edge retention and corrosion resistance. Blade length: 3 1/8". Overall length: 6 1/2". Weight: 2.5 oz. Item No. 120612 \$ 249.00

6 BOKER INTEGRAL HUNTER THUYA. A fully integral hunting knife forged out of one piece of 440C stainless steel. The drop point blade is ideal for field dressing large game. The handles are rare Thuya wood. Comes complete with a high grade leather sheath. Blade length: 3 3/8". Overall length: 7 3/4". Weight: 6 oz. Item No. 120535TH \$ 289.00

7 BOKER SAVANNAH. This professional hunting and outdoor knife has an impressive blade and elegant flowing lines in its design. The concept of this piece, by Armin Stütz (from the Austrian Knife Forge "Steirer Eisen"), was created due to experiences with big game hunting in Africa and in cooperation with professional rangers, and was approved under these harsh conditions. The massive blade features an attractive two-tone finish, and is made of N690B0 steel, which is a special alloy containing cobalt, exclusively created in a collaboration between Austrian steel manufacturer Böhler and Boker. This high performance steel can handle any cutting task, and the full tang design of this piece provides extraordinary strength and stability. The elaborately grooved canvas Micarta scales provide not only a characteristic look but also an extremely secure grip, even when wearing gloves or in wet conditions. A red fiber underlay enhances its unique design. Stainless

steel bolsters and a lanyard hole complete this high class knife. A reliable and powerful companion for all outdoor activities. High quality leather sheath included. Blade thickness: 3/16". Blade length: 4 5/8". Overall length: 9 3/8". Weight: 7.8 oz. Item No. 120620 \$ 415.00



BÖHLER
N690B0



BÖKER
MANUFATUR SOLINGEN

The legend lives on.

1
Boker A-F
5.5.
\$ 445.00

Features: extended tang/glass-breaker tip, lanyard hole and green canvas Micarta handle... to name a few!



Premium tactical sheath by Spec-Ops Brand (USA)



2
Boker A-F 12.
\$ 209.00



3
Boker A-F 11.
\$ 215.00



4
Boker A-F
EDC.
\$ 309.00



5
Boker A-F 546.
\$ 185.95



1 BOKER A-F 5.5. Few custom knifemakers have had such an influence on the tactical knife scene as William W. "Bill" Harsey. His designs have developed an impeccable reputation in the world of tactical knives. His custom versions are sought out across the globe, and they are difficult to obtain. And now, Boker is grateful and proud to announce a new collaboration with Mr. Harsey, resembling the legendary Applegate-Fairbairn dagger. The Harsey 5.5 is in use with several elite units around the world, and will be enhanced with modern features, to create a highly functional knife concept. The blade length provides the perfect compromise between utility and ease of carry. The expanded width and improved geometry of the double-edged, bead blasted 440C high performance steel

blade immensely improve its cutting capabilities. The extended tang doubles as a glass-breaker, and the CNC machined handles, crafted of green canvas Micarta, are extremely durable and comfortable, providing a secure grip even in wet conditions. This piece comes complete with a foliage green premium tactical sheath, manufactured by Spec-Ops Brand (USA), which can be mounted in various positions and has a pouch on top, for other gear (such as a multi-tool). Blade length: 5 1/2". Overall length: 10 5/8". Weight: 8.5 oz. Item No. 120545 \$ 445.00

2 BOKER A-F 12. Boker's reissue of the Applegate-Fairbairn Fighting Knife uses fiberglass-reinforced Delrin handle, thickened in the center for a sure grip. A lanyard hole adds

convenience. The handle meets a short, forward-bending cross-guard that protects the fingers. Boker achieved the knife's preferred rearward balance by inserting steel weights into the handle - a beautifully ergonomic design. The 6" blade on this 10 3/4" knife has effective reach, with a 1" wide blade that's beefy all the way to the tip. Struck of Solingen 440C stainless steel hardened to a Rockwell of 58, the blade has the signatures of Rex Applegate and W.E. Fairbairn etched into the bead-blasted finish. Includes Kydex sheath and Tek-Lok. Item No. 120543AF \$ 209.00

3 BOKER A-F 11. Boker Applegate-Fairbairn Fighting Knife with partially serrated edge. Includes Kydex sheath and Tek-Lok. Overall length: 10 3/4". All other specifications same as model 120543AF (above). Item No. 120543AFS \$ 215.00

4 BOKER A-F EDC. The latest evolution of the famous Applegate-Fairbairn boot knife. The A-F EDC offers a maximum of versatility and stability for various tasks. The 440C stainless steel blade with a fine satin finish provides excellent corrosion resistance and edge retention. A modified spear point shape with the massive blade spine makes this knife ideal for real heavy duty use, but also handy and comfortable to carry. The CNC-milled canvas Micarta handle combines perfectly with the matte black handguard and provides a firm and secure grip under all conditions. Includes a high quality leather sheath. Blade length: 4 7/8". Overall length: 9". Weight: 7 oz. Item No. 120548 \$ 309.00

5 BOKER A-F 546. Applegate Combat Knife. This fighting knife is 9" overall, but the 4 3/4" dagger blade is big enough to handle real action. It's crafted of 440C stainless steel, hollow-ground on one side and serial numbered. Includes a durable Kydex sheath and Tek-Lok. Item No. 120546 \$ 185.95



6
Boker
Applegate
Besh-
Wedge.
\$ 209.00



6 BOKER APPLAGATE BESH-WEDGE®. Two top tactical features come together for a unique combat knife. The proven Applegate with its well-balanced design guarantees excellent handling, while the ergonomics allow a fast and safe change of the grip position. The blade incorporates the special Besh-Wedge® design, developed by the Canadian knifemaker Brent Beshara, which combines an extraordinary tip strength with maximum penetration capability. The bead blasted blade is made out of 440C stainless steel. A high quality Kydex sheath allows various carry positions. Blade thickness: 4.4mm. Blade length: 6". Overall length: 11". Weight: 9.4 oz.
Item No. 120542 \$ 209.00

7 BOKER A-F 12B. Same as the original A-F 12 model (item 120543AF), but with a black coated blade and black guards. Includes Kydex sheath and Tek-Lok.
Item No. 120543B \$ 249.00

8 BOKER A-F 543DES. Desert Storm. Based on the original Applegate-Fairbairn fighting knife, model 120543AF, this desert version resulted from Operation Desert Storm. All of the features that made the original fighting knife a classic are retained in this desert version, and are enhanced with a black stainless steel cross-guard, black screws and a desert colored handle. The knife is carried securely in the desert tan Kydex sheath (Tek-Lok included). Each knife is serialized. Weighs 8.5 oz.
Item No. 120543DES \$ 209.00

8
Boker A-F
543DES.
\$ 209.00

9 BOKER APPLAGATE PREMIUM. The classic Applegate-Fairbairn dagger, which has proven itself countless times during heavy duty tasks, is now available in this exclusive version for the collector. A perfectly rounded handle, made of specially selected Grenadill wood, will mesh seamlessly in your hand, while the satin ground surface of the 440C stainless steel blade is sure to impress the serious knife enthusiast. The black-coated handguard adds character and charm. This is a must-have for any collection! Each piece is serialized and includes a premium leather sheath. Blade length: 5 7/8". Overall length: 10 3/4". Weight: 9.2 oz.
Item No. 120543W \$ 309.00

9
Boker
Applegate
Premium.
\$ 309.00

10 BOKER APPLAGATE PREMIUM BOOT. Same impressive specifications as model 120543W (above), but in a smaller size. Blade length: 4 7/8". Overall length: 9". Weight: 6 oz.
Item No. 120546W \$ 289.00

10
Boker Applegate
Premium Boot.
\$ 289.00



11
Boker A-F T2.
\$ 20.95

11 BOKER A-F T2. Official Applegate-Fairbairn neoprene training knives can be chalked to verify "scores" on opponent. 11 3/8" overall. Set of two.
Item No. 02B0544 \$ 20.95



BÖKER
MANUFACTORY SOLINGEN

True Classics.

1
Boker Fellow
White Bone.
\$ 112.95



2
Boker Davis
Classic Hunter.
\$ 269.00



W.C. Davis

3
Boker Titan
Worker.
\$ 389.00



4
Boker Titan
Hunter Stag.
\$ 475.00



SELECTED FOR USE IN
SPACE SHUTTLES: THE
EXCLUSIVE CRONIDUR
30 STEEL

1 BOKER FELLOW WHITE BONE. A classic design, featuring an elegant smooth white bone handle and 4034 stainless steel blade. The flat handle design, with a thickness of less than 1/2", makes it convenient to carry, while the handle and blade size allow serious work. A great everyday companion! Blade length: 3 1/4". Overall length: 7 1/2". Weight: 3.6 oz. Item No. 111000 \$ 112.95

2 BOKER DAVIS CLASSIC HUNTER. A premier introduction - already set to be a true classic. The design of Missouri knifemaker, W. C. Davis, stands out with the traditional drop point blade, whose shape has proven successful in the areas of hunting and outdoor use for decades. The stainless steel tang and bolsters carry scales of polished green canvas Micarta, which provides an excellent grip, even under

wet conditions. The red fiber layers create an attractive contrast to the brushed steel. The blade steel is high quality N690B0, with a Rockwell Hardness of 58-60, and offers a most impressive cutting ability. Another special aspect of this piece is its slim-line construction, which allows comfortable carry in the pocket. Blade length: 3 1/2". Overall length: 8 1/2". Weight: 5.3 oz. Item No. 110624 \$ 269.00

3 BOKER TITAN WORKER. The "everyday version" of our exclusive Titan Hunter, with an extraordinary price-performance ratio. The brown canvas Micarta scales provide a comfortable and secure grip, even under cold or wet conditions. The bolsters and the massive liners are made out of titanium for extreme durability, and the 440C stainless steel blade gives outstanding edge retention. The pocket clip and lanyard hole complete this versatile piece. Blade length: 3 1/2". Overall length: 8". Item No. 110172 \$ 389.00

4 BOKER TITAN HUNTER STAG.

The difficulty in hunting big game will always be there, and a successful hunt brings about a feeling of "mission accomplished!" But anyone who has been there realizes that this is when the real work begins. So why use a knife that is awkward, dull and dangerous? Not only is this design a classic hunter that feels good in your hand, the blade steel, Cronidur 30, will perform like no other. Cronidur 30, coming out of the space shuttle program, is one of the latest premium steels, and Boker is the only company to have it available to the sporting knives industry. It was developed for use in the aircraft and aerospace applications, where component durability, reliability and long life are a must. It is also superior in corrosion resistance to 440C stainless steel. Large carbides evident in other high grade steels do not exist in Cronidur 30. Instead, there is a homogenous structure of finely dispersed carbon nitrides. With a Rockwell hardness of 58 and the blade composition needed, these blades will sharpen and hold an edge unlike any other steel currently available. Also features a titanium liner lock and bolsters for weight reduction and durability, and a rugged stag handle. Includes leather sheath. Blade length: 3 1/2". Closed length: 4 1/2". Weight: 3.5 oz. Item No. 110171 \$ 475.00

NEW

6
Boker Pen Knife
Evergreen.
\$ 74.95

NEW

5
Boker Camp
Knife Evergreen.
\$ 149.95

7
Boker Delicate
Evergreen.
\$ 82.95

NEW

8
Boker
Copperhead
Evergreen.
\$ 84.95

NEW

LIMITED TO JUST
250 PIECES OF
EACH MODEL!

BOKER EVERGREEN SERIES. The olive tree has been in cultivation since 2500 B.C., and is even mentioned in the Genesis story of Noah. While Boker Treebrand does not go back quite that far, the combination of the two presents an impressive package. We are producing a very limited run of 500 pieces of our traditional patterns with olive wood handles and stainless steel blades. Only 250 of each pattern will be available to the U.S. market. All knives are serialized and presented in an attractive box. Don't miss out on this very special production run - they will not last long! Available in six patterns:

5 BOKER CAMP KNIFE EVERGREEN.
Closed length: 3 1/2".
Item No. 110185OL \$ 149.95

6 BOKER PEN KNIFE EVERGREEN.
Closed length: 2 3/4".
Item No. 118288OL \$ 74.95

7 BOKER DELICATE EVERGREEN.
Closed length: 4".
Item No. 110093OL \$ 82.95

8 BOKER COPPERHEAD EVERGREEN.
Closed length: 3 3/4".
Item No. 112626OL \$ 84.95

9 BOKER TRAPPER EVERGREEN.
Closed length: 4 1/4".
Item No. 112525OL \$ 89.95

10 BOKER STOCKMAN EVERGREEN.
Closed length: 4".
Item No. 117474OL \$ 99.95

NEW

9
Boker Trapper
Evergreen.
\$ 89.95

NEW

10
Boker Stockman
Evergreen.
\$ 99.95



BÖKER
MANUFATUR SOLINGEN

A step above the rest.

1
Boker Optima
Stag.
\$ 196.95



**INTERCHANGEABLE
BLADE SYSTEM**



To change blades, hold down on the lock and slide the blade out. Reverse process to insert blade.

2
Boker Optima
Green Canvas.
\$ 196.95



3
Boker Optima
Delrin Set.
\$ 196.95



4
Boker Optima
Gutting Blade.
\$ 39.95



5
Boker Optima
Saw Blade.
\$ 41.95

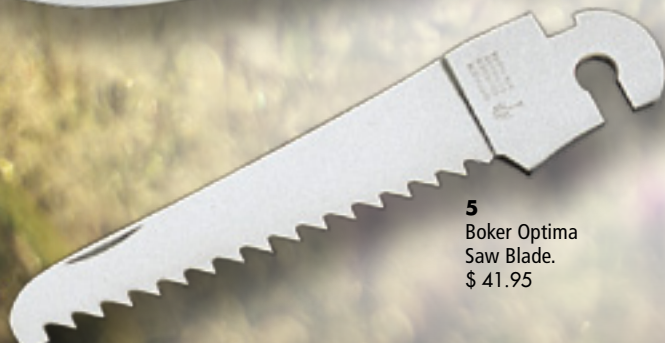

1 BOKER OPTIMA STAG. Staghorn handles are framed by distinctive nickel silver bolsters. 440C stainless steel blade. Extra blades and sheath sold separately (Optima sheaths shown on page 152). Closed length: 4¾". Blade length: 3¾".
Item No. 113004ST \$ 196.95

2 BOKER OPTIMA GREEN CANVAS. Optima gets a new look! The sturdy canvas Micarta handle scales, in classic hunter green, provide an extremely secure grip, even in wet conditions, and are resistant to environmental elements. All in all, the perfect companion for your next hunting trip or outdoor adventure! Extra blades and sheath sold separately (Optima sheaths shown on page 152). Closed length: 4¾". Blade length: 3¾".
Item No. 113005 \$ 196.95

3 BOKER OPTIMA DELRIN SET. A special Optima knife, perfectly packaged for hunters. With two useful blades - a 3⅝" Solingen stainless steel clip point and saw blade. The durable Cordura belt sheath keeps the spare blade handy. Rugged black Delrin handle, satin-finished blades and nickel silver bolsters. Closed length: 4¾". Weight: 7.5 oz. Specially priced set.
Item No. 113103 \$ 196.95

4 BOKER OPTIMA GUTTING BLADE. Interchangeable gutting blade made of stainless steel, engineered for easy re-sharpening. Length: 3½".
Item No. 119013 \$ 39.95

5 BOKER OPTIMA SAW BLADE. Interchangeable Solingen stainless steel saw blade cuts effortlessly both ways. Length: 3½".
Item No. 119012 \$ 41.95

6
Boker Stag Lock
Blade Hunter.
\$ 185.95



7
Boker Rosewood
Hunter.
\$ 165.95



8
Boker Thuya
Wood Lock
Blade Hunter.
\$ 185.95



9
Boker Mother-
of-Pearl Hunter.
\$ 309.00



10
Boker Buffalo
Horn Hunter.
\$ 185.95



BOKER CLASSIC LOCK BLADE HUNTERS. Carefully crafted for comfort and control, BOKER's lock blade hunting knives have all the quality features you've come to expect, artfully executed with rugged beauty. All the knives feature 3 1/8" stainless steel blades that offer years of dependable service. Nickel silver bolsters add a stylish gleam. Handles crafted with finger grooves and palm swell fit the hand perfectly while providing sure control. Overall length: 7 1/4". Weight: 5.6 oz. All knives shown on this page include brown leather sheath, model 090033 (except model 112005).

6 BOKER STAG LOCK BLADE HUNTER. Genuine stag handles complement this lock blade knife with a 440C stainless steel blade.
Item No. 112004ST \$ 185.95

7 BOKER ROSEWOOD HUNTER. Elegant rosewood handles adorn this knife. With Solingen stainless steel blade.
Item No. 112002 \$ 165.95

8 BOKER THUYA WOOD LOCK BLADE HUNTER. Features a 440C stainless steel blade and warm-toned African Thuya wood handles.
Item No. 112002TH \$ 185.95

9 BOKER MOTHER-OF-PEARL HUNTER. Handsome Mother-of-Pearl handles accompany a 440C stainless steel blade. No sheath; includes presentation box. *Limited availability on this item, due to a scarcity of pearl.*
Item No. 112005 \$ 309.00

10 BOKER BUFFALO HORN HUNTER. This knife features a 440C stainless steel blade set in handsome water buffalo horn handles.
Item No. 112007 \$ 185.95



BOKER
MANUFATUR SOLINGEN

For the hunt... with a trusted companion.



1
Boker Stag
Hunter.
\$ 209.00



2
Boker Green
Bone Hunter.
\$ 154.95



3
Boker Stag
Folding Hunter.
\$ 185.95



4
Boker Cronidur
Lockback.
\$ 185.95

SELECTED FOR USE IN
SPACE SHUTTLES: THE
EXCLUSIVE CRONIDUR
30 STEEL

1 BOKER STAG HUNTER. This large, sturdy lock blade knife features a 440C stainless steel blade, solid brass bolsters, and rugged stag handle. Includes a leather belt sheath (model 090032). Blade length: 3 1/4". Closed length: 4 3/4". Overall open length: 8". Weight: 5.3 oz. Item No. 114000 \$ 209.00

2 BOKER GREEN BONE HUNTER. This large, sturdy lock blade knife features a 440C stainless steel blade, solid brass bolsters, and handsome green bone handle. Includes a leather belt sheath (model 090032). Blade length: 3 1/4". Closed length: 4 3/4". Overall open length: 8". Weight: 5.3 oz. Item No. 113000 \$ 154.95

3 BOKER STAG FOLDING HUNTER. A must for the collector of stag. This folding lockback features solid nickel silver bolsters, brass liners and a 440C stainless steel drop point blade. Includes a high quality leather sheath. Blade length: 3". Overall length: 7". Weight: 4.2 oz. Item No. 110135HH \$ 185.95

4 BOKER CRONIDUR LOCKBACK. Boker's classic lockback hunting knife, featuring Cronidur 30 blade steel. Cronidur 30, coming out of the space shuttle program, is one of the latest premium steels, and Boker is the only company to have it available to the sporting knives industry. Cronidur 30 was developed for use in the aircraft and aerospace applications, where

component durability, reliability and long life are a must. Cronidur 30 is superior in corrosion resistance to 440C stainless steel. Large carbides evident in other high grade steels do not exist in Cronidur 30. Instead, there is a homogenous structure of finely dispersed carbon nitrides. With a Rockwell hardness of 58 and the blade composition needed, these



5
Boker Stag
Folding Hunter.
\$ 189.95



6
Boker Rosewood
Folding Hunter.
\$ 103.95



7
Boker Delrin
Folding Hunter.
\$ 98.95



8
Boker Stag
Double Lock
Hunter.
\$ 259.00

blades will sharpen and hold an edge unlike any other steel currently available. This exclusive model also features elegant Grenadill wood handles and nickel silver bolsters. The handles are expertly crafted with finger grooves and palm swell to fit the hand perfectly while providing sure control. Includes leather sheath, model #090033. Blade length: 3 1/8". Overall length: 7 1/4". Weight: 5.6 oz. Item No. 112013 \$ 185.95

5 BOKER STAG FOLDING HUNTER. This sturdy slip joint folder features all the superior qualities of model 112020, but with rugged stag handles. Closed length: 5 1/4". Leather sheath included (model 090034). Item No. 112020HH \$ 189.95

6 BOKER ROSEWOOD FOLDING HUNTER. The hunter's pride. This classic slip joint folder features 4" clip and skinning blades of high carbon steel, and rosewood handles with polished nickel silver bolsters. Closed length: 5 1/4". Leather sheath included (model 090034). Item No. 112020 \$ 103.95

7 BOKER DELRIN FOLDING HUNTER. A practical slip joint knife for the outdoorsman with all the superior qualities of 112020 (above), but with durable Delrin handles. Closed length: 5 1/4". Leather sheath included (model 090034). Item No. 112020DELRIN \$ 98.95

8 BOKER STAG DOUBLE LOCK HUNTER. You'll find so many uses for this knife, you'll wonder how you got along without it. Double lock hunter with attractive stag handles, nickel silver bolsters, a 4" clip point blade of 440C stainless steel, and a stainless steel saw blade (with a separate lock for each blade). Closed length: 5 1/4". Leather sheath included (model 090034). Item No. 1140215 \$ 259.00



BÖKER
MANUFATUR SOLINGEN

The original sportsmen.



1
Boker Camp
Knife Smoked
Oak.
\$ 209.00



2
Boker Camp
Knife Delrin.
\$ 165.95



3
Boker Camp
Knife Stag.
\$ 209.00

1 BOKER CAMP KNIFE SMOKED OAK. The flagship of the Boker Solingen production facility is now offering the famous scout/camp knife in a version featuring smoked oak scales. As a collectible or as a user's knife, this is sure to be a favorite. Features two blades, a can opener, cap lifter, leather punch and reamer, cork screw and flathead screwdriver. Blade steel is 4034 stainless. Includes a high quality leather pouch with chain. Blade length: 2½" and 1¾". Closed length: 3½". Weight: 3.3 oz. Item No. 110183 \$ 209.00

2 BOKER CAMP KNIFE DELRIN. Same features and specifications as model 110183 (above), but with a rugged black Delrin handle and classic frosted etch. Pouch not included. Blade length: 2½" and 1¾". Closed length: 3½". Weight: 3.3 oz. Item No. 110182R \$ 165.95

3 BOKER CAMP KNIFE STAG. This six-piece pocket knife features polished nickel silver bolsters and durable genuine stag handles. Offers two blades, a can opener, cap lifter, leather punch and reamer, cork screw and flathead screwdriver. Blades are made of 4034 stainless steel. A necessary companion in any situation! Blade length: 2½" and 1¾". Closed length: 3½". Weight: 3.5 oz. Item No. 110182HH \$ 209.00

4 BOKER HUNTER'S POCKET KNIFE. Responding to requests from our loyal customers, we are offering this popular European folder with an extremely useful saw blade. The spearpoint blade and cork screw add to this classic, featuring 440C stainless steel and rugged stag handles. Blade length: 3¼". Overall length: 7⅝". Weight: 6 oz. Item No. 110636 \$ 309.00

5 BOKER QUADRO GREEN MICARTA. Due to the tremendous success of our original Hunter's Pocket Knife (model 110636), we now offer it with an additional blade (blunt tip), and a green canvas Micarta handle, which

enhances the grip in wet conditions and offers superior resistance to the elements. The spearpoint blade and cork screw add to this classic, featuring 440C stainless steel. Blade length: 3¼". Overall length: 7⅝". Weight: 6 oz. Item No. 110644 \$ 309.00

Appaloosa – tough, dependable, spirited. This series of traditional folding knives is dedicated to the famous Appaloosa horse. Appaloosa horses were introduced to Mexico by the Spanish in the 1500's, and later spread throughout North America. Over the years,

High quality leather sheath and chain available for our Camp Knives! Sold separately; see page 152.



their name has transformed from "A Palouse Horse" to "Palousey" to "Appalousey" and finally to "Appaloosa."

Characterized by their incredible strength and stamina, these horses can be distinguished by their unique coloring – various shades of brown and white, in the form of irregular spots. This was the inspiration for the beautifully structured bone handles we chose for this series. The dark and light spots on the scales make each knife truly unique. We have also designed a special new Boker shield, exclusively for this premium series. Blades are made of C-75 carbon steel.

6 BOKER COPPERHEAD. 3¾" closed. Item No. 112626AB \$ 74.95

7 BOKER STOCKMAN. 4" closed. Item No. 117474AB \$ 82.95

8 BOKER TRAPPER. 4¼" closed. Item No. 1102525AB \$ 72.95

4
Boker Hunter's
Pocket Knife.
\$ 309.00



5
Boker Quadro
Green
Micarta.
\$ 309.00



6
Boker
Copperhead.
\$ 74.95



8
Boker Trapper.
\$ 72.95



7
Boker
Stockman.
\$ 82.95



BÖKER
MANUFATUR SOLINGEN

From the office to the ranch.

1
Boker Pocket
Lock Blade.
\$ 91.95



2
Boker Pocket
Lock Blade Stag.
\$ 119.95



3
Boker Titan 2.
\$ 93.95



4
Boker
Trapperliner
\$ 98.95



5
Boker
Trapperliner
Stag.
\$ 144.95



BOKER TRAPPERLINERS. Take one of our most traditional patterns, the Trapper, and add the convenience of one-hand open and close. Features Solingen stainless steel blades and nickel silver pins, liners and bolsters. Locking liner and thumb stud allow for easy one-hand operation. Blade length: 3 1/4". Closed length: 4 3/8". Available in two versions:

4 With smooth red bone handle.
Item No. 114711 \$ 98.95

5 With genuine stag handle.
Item No. 114715 \$ 144.95

6 BOKER COPPERLINER STAG. Combine the tradition of a pocket knife with the ease of opening and closing with one hand. Features a genuine stag handle, Solingen stainless steel blade and nickel silver pins, liners and bolsters. Locking liner and thumb stud allow for easy one-hand operation. Blade length: 2 5/8". Closed length: 3 3/4".
Item No. 114610 \$ 103.95

6
Boker
Copperliner
Stag.
\$ 103.95



1 BOKER POCKET LOCK BLADE. With a 2" Solingen stainless steel locking blade, brass liners, nickel silver bolsters and richly finished rosewood handles. Convenient "pocket size." Overall length: 4 1/2".
Item No. 111004 \$ 91.95

2 BOKER POCKET LOCK BLADE. Same specifications as model 111004 (above), but with rugged stag handles.
Item No. 111006 \$ 119.95

3 BOKER TITAN 2. A Boker innovation for those who need a tough knife and want one that's lightweight. This small, thin lock blade knife weighs only 1.5 oz., yet it's strong enough to endure hard work. 2 1/2" Solingen stainless steel blade with pure titanium handles. Overall open length: 5 1/2".
Item No. 112009 \$ 93.95

7
Boker Beer Barrel
Stockman.
\$ 82.95



8
Boker Beer
Barrel Whittler.
\$ 72.95



BOKER BEER BARREL. The oldest evidence that beer was brewed in Germany comes from around 800 B.C. By the second century, beer was being traded commercially in Germany. In 1516, Duke Wilhelm IV of Bavaria enacted the Reinheitsgebot, or the "Purity Law," which regulated the brewing of beer in Germany. The town of Solingen, known as the cutlery center of Germany, also enacted strict laws for the manufacture of knives and shears. While Boker is not quite as "aged" as the brewing industry, the same quality standards apply. To commemorate this common interest, Boker is introducing a series of traditional pocketknives with handles made from genuine German ale/beer barrels, handcrafted in the Solingen factory. Each pattern will include solid nickel silver bolsters, brass liners, carbon steel blades and the resurrected old Tree Brand blade etching. A great item for the collector or everyday user.

9
Boker Beer
Barrel
Copperhead.
\$ 72.95



10
Boker Beer
Barrel Canoe.
\$ 72.95



11
Boker Beer
Barrel Trapper.
\$ 72.95

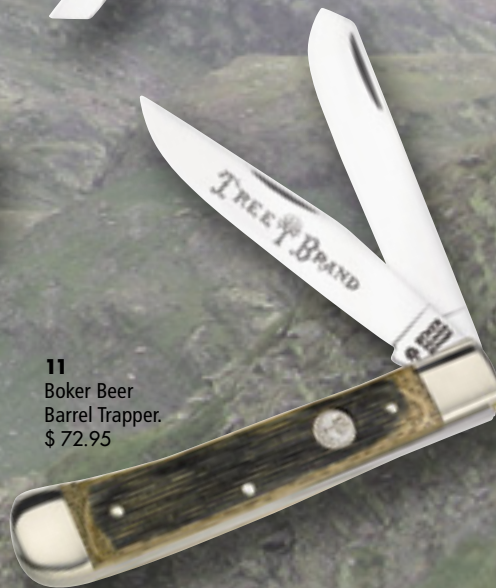

7 BOKER BEER BARREL STOCKMAN.
Closed length: 4".
Item No. 117474BBL \$ 82.95

8 BOKER BEER BARREL WHITTILER.
Closed length: 3½".
Item No. 110280BBL \$ 72.95

9 BOKER BEER BARREL COPPERHEAD.
Closed length: 3¾".
Item No. 112626BBL \$ 72.95

10 BOKER BEER BARREL CANOE.
Closed length: 3⅝".
Item No. 110200BBL \$ 72.95

11 BOKER BEER BARREL TRAPPER.
Closed length: 4¼".
Item No. 112525BBL \$ 72.95

12 BOKER BEER BARREL CONGRESS.
Closed length: 3¾".
Item No. 115464BBL \$ 82.95

12
Boker Beer
Barrel Congress.
\$ 82.95



BÖKER
MANUFATUR SOLINGEN

1
Boker Red Bone
Whittler.
\$ 73.95



2
Boker Stag
Medium
Stockman.
\$ 103.95



3
Boker Stag
Stockman.
\$ 144.95



4
Boker Green
Bone Medium
Stockman.
\$ 72.95

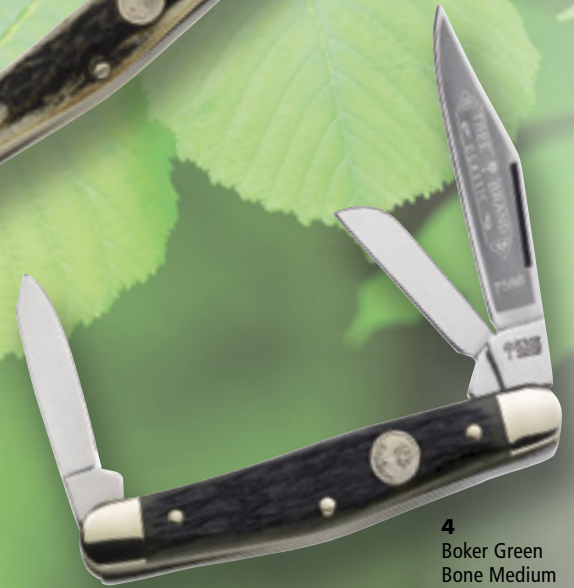

5
Boker Stag
Trapper.
\$ 144.95



6
Boker Red
Bone Premium
Stockman.
\$ 90.95



7
Boker Rosewood
Premium
Stockman.
\$ 77.95



1 BOKER RED BONE WHITTILER. This folding deluxe Whittler with carbon steel clip, pen and coping blades is everything the craftsman wants in a knife, starting with a 2½" master blade. The handles are rich jugged red bone. Closed length: 3½".
Item No. 110280JRB \$ 73.95

2 BOKER STAG MEDIUM STOCKMAN. Handsome medium stockman with rugged stag handles and carbon steel blades. Closed length: 3¼".
Item No. 117588HH \$ 103.95

3 BOKER STAG STOCKMAN. A folding pocket knife with character and beauty. Stag handles and nickel silver bolsters hold 440C stainless steel clip, sheepfoot and spey blades. Closed length: 4".
Item No. 114474 \$ 144.95

4 BOKER GREEN BONE MEDIUM STOCKMAN. A smaller pocket knife – just 3½" closed. Carbon steel clip, sheepfoot and spey blades are set in jugged green bone handles with nickel silver bolsters.
Item No. 117588 \$ 72.95

5 BOKER STAG TRAPPER. A trapper with sturdy stag handles and nickel silver bolsters that's as at home in a suit pocket as it is in denim. Clip and spey blades of 440C stainless steel. Closed length: 4¼".
Item No. 114525 \$ 144.95

6 BOKER RED BONE PREMIUM STOCKMAN. This Stockman knife features Solingen stainless steel clip, sheepfoot and spey blades. Attractive red bone handles with nickel silver bolsters. A treasure! Closed length: 4".
Item No. 117474SS \$ 90.95

7 BOKER ROSEWOOD PREMIUM STOCKMAN. This popular model offers carbon steel clip, sheepfoot and spey blades. Handles are classic rosewood with polished nickel silver bolsters. Without a doubt, a knife anyone would be proud to carry. Closed length: 4".
Item No. 117474 \$ 77.95

8 BOKER ROSEWOOD PEN KNIFE. A mini-masterpiece! This elegant pen knife features carbon steel clip and pen blades, and handsome rosewood handles. Closed length: 2¾".
Item No. 1182881 \$ 72.95

9 BOKER RED BONE PEN KNIFE. A favorite of hunters and fishermen. This red bone beauty is always popular, with its Solingen stainless steel blades, nickel silver bolsters and rich red bone handles. Closed length: 2¾".
Item No. 118288SS \$ 77.95

10 BOKER BIRD KNIFE. The bird hunter's trusted companion. A 3¼" stainless steel blade complements an elongated gut hook for versatile use



8
Boker Rosewood
Pen Knife.
\$ 72.95



9
Boker Red Bone
Pen Knife.
\$ 77.95

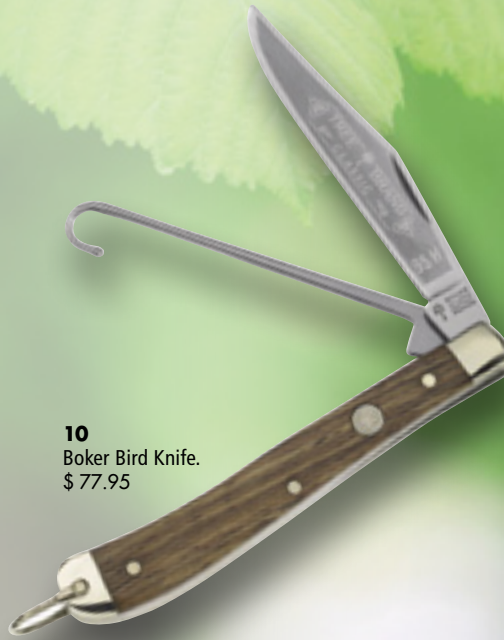

10
Boker Bird Knife.
\$ 77.95



11
Boker Stag Pen
Knife.
\$ 82.95

in the field. Rosewood handles and nickel silver bolsters ensure long and faithful use. Closed length: 4".
Item No. 110093H \$ 77.95

11 BOKER STAG PEN KNIFE. Sometimes the best things come in small packages. This handsome pen knife is a case in point with its stainless steel blades and rustic stag handles. Closed length: 2¾".
Item No. 118288HH \$ 82.95

12 BOKER CARVER'S CONGRESS WHITTILER. Designed by a carver, for carvers. Special blade configuration Congress knife for the carver in the family. Carbon steel sheepfoot, pen, coping and spey blades with rosewood handle. Closed length: 3¾".
Item No. 115465 \$ 82.95



12
Boker Carver's
Congress
Whittler.
\$ 82.95



BÖKER
MANUFATUR SOLINGEN

Traditionally speaking...

1
Boker Medium
Stockman.
\$ 36.95



2
Boker Medium
Stockman.
\$ 36.95



3
Boker
Copperhead.
\$ 36.95



4
Boker
Copperhead.
\$ 36.95



5
Boker Stockman.
\$ 41.95



6
Boker Stockman.
\$ 41.95



BOKER TRADITIONAL SERIES.
This series of traditional pocket knives offers all the best components. Featuring bone scales, nickel silver bolsters, brass linings and high carbon stainless steel blades. For those who don't mind using two hands.

1 BOKER MEDIUM STOCKMAN. With jiggered black bone handle. Closed length: 3½".
Item No. 110728 \$ 36.95

2 BOKER MEDIUM STOCKMAN. With jiggered brown bone handle. Closed length: 3½".
Item No. 110727 \$ 36.95

3 BOKER COPPERHEAD. With jiggered brown bone handle. Closed length: 3¾".
Item No. 110723 \$ 36.95

4 BOKER COPPERHEAD. With smooth red bone handle. Closed length: 3¾".
Item No. 110724 \$ 36.95

5 BOKER STOCKMAN. With jiggered black bone handle. Closed length: 4".
Item No. 110725 \$ 41.95

6 BOKER STOCKMAN. With jiggered brown bone handle. Closed length: 4".
Item No. 110726 \$ 41.95

7 BOKER CONGRESS. With jiggered brown bone handle. Closed length: 3⅝".
Item No. 110721 \$ 41.95

8 BOKER CONGRESS. With jiggered black bone handle. Closed length: 3⅝".
Item No. 110722 \$ 41.95

9 BOKER CONGRESS. With smooth red bone handle. Closed length: 3⅝".
Item No. 110720 \$ 41.95

10 BOKER TRAPPER. With jiggered black bone handle. Closed length: 4¼".
Item No. 110733 \$ 41.95



7
Boker
Congress.
\$ 41.95



8
Boker Congress.
\$ 41.95



9
Boker Congress.
\$ 41.95



10
Boker Trapper.
\$ 41.95



11
Boker Trapper.
\$ 41.95

NEW



12
Boker Trapper.
\$ 79.95



13
Boker Trapper.
\$ 41.95



14
Boker Trapper.
\$ 41.95

11 BOKER TRAPPER. With smooth yellow bone handle. Closed length: 4¼". Item No. 110731 \$ 41.95

12 BOKER TRAPPER. With rugged stag handle. Closed length: 4¼". Item No. 110729 \$ 79.95

13 BOKER TRAPPER. With smooth red bone handle. Closed length: 4¼". Item No. 110730 \$ 41.95

14 BOKER TRAPPER. With jigsawed brown bone handle. Closed length: 4¼". Item No. 110732 \$ 41.95



BÖKER
MANUFATUR SOLINGEN

Upon Request...

1
Boker Stockman.
\$ 41.95

Production
Prototype
Picture



Production
Prototype
Picture



2
Boker Folding
Hunter.
\$ 61.95

3
Boker Trapper.
\$ 41.95



Production
Prototype
Picture

3 BOKER TRAPPER. With faux tortoise handle scales. Closed length: 4 1/4". Item No. 110731T \$ 41.95

4 BOKER SINGLE BLADE SLIM LINE TRAPPER. With jiggled green bone handle scales. Closed length: 4". Item No. 110735 \$ 36.95

5 BOKER GENTLEMAN'S LOCKBACK. With white bone handle scales. Closed length: 3 3/4". Item No. 110250WB \$ 36.95

6 BOKER SLIM LINE TRAPPER. With jiggled green bone handle scales. Closed length: 4". Item No. 110736 \$ 41.95

7 BOKER SINGLE BLADE TRAPPER. With jiggled green bone handle scales. Closed length: 4 1/4". Item No. 110734 \$ 38.95

BOKER TRADITIONAL SERIES.

This new series of traditional pocket knives offers all the best components. Featuring nickel silver bolsters, brass linings and high carbon stainless steel blades. For those who don't mind using two hands.

1 BOKER STOCKMAN. With faux tortoise handle scales. Closed length: 4". Item No. 110726T \$ 41.95

2 BOKER FOLDING HUNTER. With faux tortoise handle scales. Closed length: 5 1/4". Item No. 110273T \$ 61.95

8 BOKER FOLDING HUNTER. With jiggled brown bone handle scales. Closed length: 5 1/4". Item No. 110273BB \$ 61.95

4
Boker Single
Blade Slim Line
Trapper.
\$ 36.95

Production
Prototype
Picture

6
Boker Slim
Line Trapper.
\$ 41.95

Production
Prototype
Picture

Production
Prototype
Picture

5
Boker
Gentleman's
Lockback.
\$ 36.95

Production
Prototype
Picture

7
Boker Single
Blade Trapper.
\$ 38.95

Production
Prototype
Picture

8
Boker Folding
Hunter.
\$ 61.95



BÖKER
MANUFATUR SOLINGEN

A rancher's best friend.

2
Cinch®
Rangebuster Jr.
\$ 31.95



1
Cinch® Stag
Stockman.
\$ 113.95



3
Cinch®
Stockman.
\$ 41.95



4
Cinch®
Trapperliner.
\$ 122.95



5
Cinch®
Trapper.
\$ 41.95

1 CINCH® STAG STOCKMAN. A traditional stock knife featuring clip, spey and sheepfoot blades, with the beauty and character of stag handles. Nickel silver bolsters and solid brass liners. Stainless steel blades. Closed length is 4".
Item No. 11CI7474ST \$ 113.95

2 CINCH® RANGEBUSTER JR. A must for the ranch hand. This basic folding hunter knife is built for rugged everyday work chores. Features a stainless steel blade and yellow polypropylene handle that will hold up against fertilizer, solvents, etc. Closed length: 3 5/8".
Item No. 01CI403Y \$ 31.95

3 CINCH® STOCKMAN. A traditional stock knife featuring clip, spey and sheepfoot blades, with handsome jugged brown bone handles. Nickel silver bolsters and solid brass liners. High carbon stainless steel blades. Closed length is 4".
Item No. 11CI0726 \$ 41.95

4 CINCH® TRAPPERLINER. Combine the tradition of a pocket knife with the ease of one-handed open and close. Genuine stag handles and stainless steel blade. Closed length is 4 1/4".
Item No. 11CI4715 \$ 122.95

5 CINCH® TRAPPER. Heading out without one of these in your pocket is like leaving without your boots on. This knife will do it all and is considered by many to be the rancher's favorite. The yellow bone handles are offset by clip and spey blades. And for those looking for a good edge and one that sharpens up the way that you want, these blades are high carbon stainless steel. Closed length is 4 1/4".
Item No. 11CI0731 \$ 41.95

6 CINCH® GENTLEMAN'S LOCKBACK. An ideal pocket knife for the office or small everyday work chores. Features stag handles and stainless steel blade. Back locking mechanism for safety. Closed length is 2 1/2".
Item No. 11CI1006 \$ 98.95

7 CINCH® CLASSIC FOLDING HUNTER. An ideal hunting knife or for heavy work duties. Stag handles, solid nickel silver bolsters and liners. Carbon steel blade. Closed length is 4 1/8". Comes complete with a high grade leather sheath.
Item No. 11CI2004ST \$ 175.95



6
Cinch® Gentleman's
Lockback.
\$ 98.95



7
Cinch® Classic
Folding Hunter.
\$ 175.95



CINCH® KNIVES

8 CRUEL GIRL® ACTION R. The first under the Cruel Girl® brand. This Action roping knife will perform and look good at the same time. Features a super tough AUS-8 stainless steel blade, partially serrated, and a durable Zytel handle with lanyard hole and pocket clip. Easy one-handed opening with a sturdy backlock mechanism. Blade length: 3". Overall length: 7 1/8". Weight: 1.5 oz.
Item No. 01CI092P \$ 41.95

9 CINCH® ACTION R. Same specifications as model 01CI092P (above), but with a black Zytel handle and Cinch® blade etching.
Item No. 01CI092 \$ 41.95

CINCH® ROPING KNIFE. The workhorse of the Cinch® line of premium cutlery is the Cinch® Roping Knife. Lightning fast deployment puts the knife where you need it at critical times. Stainless steel handles matched with an aggressive partially serrated blade of AUS-8 steel. Pocket clip is reversible for tip-up or tip-down carry. Secure back locking mechanism. Lanyard hole provides additional security. Blade length: 3". Overall length: 7 1/8". Weight: 4 oz. Available in three different versions:

10 CINCH® FASTBACK. The original Fastback roping knife.
Item No. 01CI091 \$ 65.95

11 CINCH® FASTBACK II. Fastback roping knife with western scroll engraving.
Item No. 01CI091E \$ 87.95

12 CINCH® FASTBACK III. Fastback roping knife with western scroll, 24K gold.
Item No. 01CI091EG \$ 128.95

8
Cruel Girl®
Action R.
\$ 41.95

9
Cinch®
Action R.
\$ 41.95

10
Cinch®
Fastback.
\$ 65.95

11
Cinch®
Fastback II.
\$ 87.95

12
Cinch®
Fastback III.
\$ 128.95





BÖKER
ARBOLITO

Tradition:

Since 1983 the BOKER subsidiary produces high quality hunting and kitchen knives. In Spanish speaking areas of North and South America, ARBOLITO has a great reputation.
[Pages 48-53]



From the land of the Gaucho...



1
Boker Arbolito
Relincho
Madera.
\$ 134.95



2
Boker Arbolito
Relincho Cuerno
de Ciervo.
\$ 154.95



3
Boker Arbolito
Venador.
\$ 144.95



4
Boker Arbolito
Skinner Wood.
\$ 159.95

1 BOKER ARBOLITO RELINCHO MADERA. This slim hunter, with its full tang construction, offers an extremely high level of stability. The tapered tang ensures outstanding ergonomics and perfect balance. The beautifully grained Guayacan ebony scales are securely attached to the tang with attractive mosaic pins, and have a red fiber underlay, for a discreet and elegant contrast. The blade is crafted of high performance Böhler N695 steel. Comes complete with a high quality sheath made of selected Argentinean cowhide. Blade length: 5". Overall length: 9½". Weight: 5.7 oz.
Item No. 02BA303G \$ 134.95

2 BOKER ARBOLITO RELINCHO CUERNO DE CIERVO. This slim hunter, with its full tang construction, offers an extremely high level of stability. The tapered tang ensures outstanding ergonomics and perfect balance. The hand picked stag scales have a red fiber underlay, for a discreet and elegant contrast. The blade is crafted of high performance Böhler N695 steel. Comes complete with a high quality sheath made of selected Argentinean cowhide. Blade length: 5". Overall length: 9½". Weight: 6.1 oz.
Item No. 02BA303H \$ 154.95

3 BOKER ARBOLITO VENADOR. This impressive hunting knife is perfectly suited for large game, but is also a great companion for camping and trekking trips. The hollow ground blade is made of premium Böhler N695 steel, and has a fine satin finish. The decorative cutting edge gives this massive knife added appeal. The handle scales, made of hand selected Guayacan ebony wood, are attached to the tapered tang with attractive mosaic pins, with a red fiber underlay. Comes complete with a high grade sheath made of selected Argentinean cowhide. Blade length: 5". Overall length: 10". Weight: 5.7 oz.
Item No. 02BA313G \$ 144.95

4 BOKER ARBOLITO SKINNER WOOD. A conveniently shaped blade made of T6MoV stainless steel, bead blasted, topped off with a Guayacan wood handle. Includes a premium leather sheath. Blade length: 4¼". Overall length: 8⅞". Weight: 6 oz.
Item No. 02BA580GB \$ 159.95



BÖKER
ARBOLITO

Make the hard work an easy task.

1
Boker Arbolito
Pine Creek Stag.
\$ 109.95



Lairson

2
Boker Arbolito
Pine Creek
Wood.
\$ 89.95



3
Boker Arbolito
Timberwolf
Wood.
\$ 129.95



1 BOKER ARBOLITO PINE CREEK STAG. A beefy yet compact hunting and outdoor knife, designed by American knifemaker Jerry Lairson. The additional finger choil allows various grip positions, with maximum control for delicate cutting tasks, when grabbed "short" in forward choil. Notches on the blade spine provide positive control. Select stag scales with a red fiber underlay provide not only an attractive appearance, but also a safe and comfortable grip. The blade is made of high quality T6MoV steel. Includes an embossed leather sheath. Blade length: 3 5/8". Overall length: 7 1/2". Weight: 4.5 oz. Item No. 02BA701H \$ 109.95

2 BOKER ARBOLITO PINE CREEK WOOD. Same specifications as model 02BA701H (above), but with Guayacan ebony wood handle scales, fastened with mosaic pins. Item No. 02BA701G \$ 89.95

3 BOKER ARBOLITO TIMBERWOLF WOOD. Without a doubt, this knife characterizes the talent of knife smithing expert Armin Stütz, from Steirer Eisen, Austria, reflecting his sense for clean lines and functionality. The blade is made of high performance 440C stainless steel, flat ground for optimum cutting performance, and molded into a tried and true shape - all topped off with a satin finish. Especially

attractive and highly demanding in the manufacturing process is the massive stainless steel handguard, combined with the black fiber spacer. This piece is not only ideal for hunting and outdoor use, but also for the demanding knife enthusiast looking for something special and unique. The handle is crafted of sturdy cocobolo wood, contrasting perfectly with the stainless steel handguard. Includes a premium leather sheath. Blade length: 5 1/4". Overall length: 9 1/2". Weight: 6.8 oz. Item No. 02BA572 \$ 129.95

4 BOKER ARBOLITO STAG HUNTER. This knife is a blend of the best characteristics of some of our older models, but with added features. The 3 1/2" blade, made of N695 stainless steel, features a notched thumb ramp

for stability and control under adverse conditions. Premium stag scales and tapered tang make for a comfortable grip. Comes complete with a high grade leather sheath. Overall length: 7 1/2". Weight: 5 oz. Item No. 02BA319H \$ 123.95

5 BOKER ARBOLITO SKINNER STAG. A classic fixed blade that will perform any task demanded. The style, size and balance will make this knife an immediate favorite. The 3 1/4" blade, made of N695 stainless steel, features thumb and forefinger notches providing stability and control in all conditions. The tapered tang and fiber liner reduce the overall weight and provide a solid construction. Set off with premium stag scales and housed in a high grade Gaucho leather sheath. Overall length: 7 1/4". Weight: 5 oz. Item No. 02BA338H \$ 139.95

4
Boker Arbolito
Stag Hunter.
\$ 123.95



5
Boker Arbolito
Skinner Stag.
\$ 139.95



6
Boker Arbolito
El Trampero.
\$ 139.95



7
Boker Arbolito El
Trampero Ciervo.
\$ 159.95



6 BOKER ARBOLITO EL TRAMPERO. With this model, we are raising the bar to a new level, providing features found in custom knives. These new fixed blade knives are different in many ways from the classic Arbolito knives of the past. We now use Böhler N695 steel, with a full and tapered tang. The blade is made of 5mm steel, is flat ground and provides detail such as the rounded edges on the blade spine

and checkering of the thumb ramp, allowing comfortable and effective cutting. The mosaic pins that keep the exotic Guayacan wood handles in place provide additional proof of our dedication to knives. Also features a lanyard hole and includes a premium leather sheath with snap closure. Blade length: 4 1/8". Overall length: 8 1/2". Weight: 6 oz.
Item No. 02BA575G \$ 139.95

7 BOKER ARBOLITO EL TRAMPERO CIERVO. Same features and specifications as model 02BA575G (above), but with hand selected stag handles. Blade length: 4 1/8". Overall length: 8 1/2". Weight: 6.3 oz.
Item No. 02BA575H \$ 159.95



BÖKER
ARBOLITO

Rugged artistry.



1
Boker Arbolito
Stamigo.
\$ 124.95



2
Boker Arbolito
Nicker.
\$ 129.95

2 BOKER ARBOLITO NICKER. The traditional German hunting knife, "The Nicker," provides the ultimate bird and trout knife. The slender shape and the stag scales are classic elements of this type of knife, but the handle and blade design provide greater versatility for the outdoors and for general use. Red fiber underlays and stainless steel bolsters add a modern touch. The blade steel used for this Arbolito model is T6MoV. Includes a high quality embossed leather sheath. Blade length: 3¾". Overall length: 7⅞". Weight: 4.2 oz. Item No. 02BA736H \$ 129.95

1 BOKER ARBOLITO STAMIGO. Eat in style with this genuine stag handled knife and fork set with convenient leather belt sheath. Each has an overall length of 7⅞". Item No. 03BA501HH \$ 124.95

The BOKER name has always been associated with quality. The Gaucho is the cowboy of the Pampas or prairies of Argentina. While the most important companion to the Gaucho is his horse, without question the second is his gaucho knife, of which he demands quality and performance.

Combine the BOKER quality and the Gaucho demands and you have this impressive line of premium fixed blade hunting knives from the BOKER facility in Argentina... "the land of the Gaucho."

This series features stainless steel, hollow ground, satin finished blades. The stag is select premium stag. All models are accompanied by a high-grade leather sheath... just like the Gauchos wear.

3 BOKER ARBOLITO CAPER. The ultimate caping knife that just "feels good" in your hand. Genuine stag handles and a 2¼" 440A stainless steel blade. Includes leather sheath. Overall length: 5". Item No. 02BA530HH \$ 89.95

4 BOKER ARBOLITO FIXED BLADE. This traditional hunting knife features a 440C stainless steel blade, finished to perfection, and a rugged genuine stag handle. Includes a high grade leather sheath. Blade length: 4⅝". Overall length: 8⅝". Item No. 02BA545HH \$ 131.95

5 BOKER ARBOLITO HUNTER'S COMBO. The big game hunter's complete package. Set includes the 02BA510HH gutting hook and 02BA530HH caper. Combo leather sheath included. Item No. 02BA5130H \$ 184.95

6 BOKER ARBOLITO GUT HOOK. Rugged stag handle and a 440A stainless steel gut hook blade. Blade length: 4¼". Overall length: 8½". Weight: 7 oz. Item No. 02BA510HH \$ 127.95

3
Boker Arbolito
Caper.
\$ 89.95



4
Boker Arbolito
Fixed Blade.
\$ 131.95



6
Boker Arbolito
Gut Hook.
\$ 127.95



5
Boker
Arbolito
Hunter's
Combo.
\$ 184.95



BOKER ARBOLITO



BÖKER
ARBOLITO

Innovation:
Outstanding, innovative knife concepts for every mission. Designed in cooperation with
knife experts worldwide. German engineering, manufactured in Taiwan and China.
[Pages 54-99]



POLICE

Go against the flow.

MANARO →

NEW



1
Boker Plus Manaro.
\$ 210.00

Production
Prototype
Picture

BOKER PLUS



2
Boker Plus Nano.
\$ 67.95



3
Boker Plus Nano 42.
\$ 65.95



SLIP JOINT DESIGN

1 BOKER PLUS MANARO. In this impressive new piece, Sal Manaro managed to combine different kinds of checkering into one harmonizing surface. The geometry of the CNC machined checkering is fascinating, and provides outstanding comfort. The Manaro proves itself as a sturdy work knife or a versatile everyday carry piece, made with the best and the toughest materials available. The handle is crafted of titanium, and features a sturdy frame lock mechanism. The blade is made of 440C stainless steel, which has been proven superior in terms of corrosion resistance and edge holding ability. The breathtaking grind takes the full strength of the material near the tip of the blade, in the "arrow shaped" section, making the Manaro a truly unique piece. Includes pocket clip. Blade length: 3½". Overall length: 8¾". Weight: 6.5 oz. Item No. 01B0145 \$ 210.00

2 BOKER PLUS NANO. The Boker Plus Nano is breaking new ground with its remarkable concept and design by David Curtiss. The Nano clearly shows that size and utility value are not always correlated. Due to its ingenious ergonomics, the Nano sits perfectly in the hand despite its compact size of just 4¾", and can handle any cutting task with ease, while providing a superior grip. The structure of the Zytel scale enhances the slip resistance, and the

bellied blade of 440C stainless steel ensures comfortable handling with its large opening. An added bonus is the pocket clip - David Curtiss, who runs a company for water jet cutting systems, also supplies the same pocket clip for custom pieces. The sturdy steel handle features a frame lock mechanism and removable pocket clip (tip-up/tip-down carry). Blade length: 1⅞". Overall length: 4¾". Weight: 2.9 oz. Item No. 01B0597 \$ 67.95

3 BOKER PLUS NANO 42. Same impressive features and specifications as the original Nano (above), but in a slip joint model. Blade length: 1⅞". Overall length: 4¾". Weight: 2.9 oz. Item No. 01B0598 \$ 65.95





1
Boker Plus
Albatros.
\$ 171.95



2
Boker Plus
Whale.
\$ 123.95



3
Boker Plus
Field Marshal.
\$ 139.95



1 BOKER PLUS ALBATROS. After his debut in our Solingen production line with the Haddock, Cox and 67, Jens Anso from Denmark brings new models to our Boker Plus line. The Albatros boasts massive, 3.6mm thick titanium plates that form the basis for the frame lock. Between the plates sits the 5mm thick blade, made of VG-10 steel, which with its bulbous edge and slight hollow grind allows versatility and excellent cutting performance. The titanium pocket clip is reversible for tip-up or tip-down carry, and the large lanyard hole completes the package. Blade length: 2 $\frac{3}{8}$ ". Overall length: 6 $\frac{1}{2}$ ". Weight: 5.9 oz. Item No. 01BO621 \$ 171.95

2 BOKER PLUS WHALE. As the head of a humpback whale rises from the surface, the back of the blade of the new Boker Plus Whale rises above the

back line of this impressive piece. The curved handle blends seamlessly and demonstrates Jens Anso's superior skills, providing remarkable ergonomics. The titanium plates of the liner lock on the polished G-10 scales provide minimum weight, and the bronze anodized parts add an extravagant but subtly sophisticated look. The 440C stainless steel blade boasts an attractive two-tone finish. Includes a titanium pocket clip (tip-up) for easy carry. A real Anso folding knife that is sure to be a must! Blade length: 3 $\frac{1}{8}$ ". Overall length: 7 $\frac{3}{8}$ ". Weight: 3.8 oz. Item No. 01BO620 \$ 123.95

3 BOKER PLUS FIELD MARSHAL. The rather unusual designs by knifemaker Todd Begg have become very popular with many knife aficionados. His latest folding knife, the Field Marshal, is once again characterized by its extravagant style. At the same time, he puts great emphasis on high utility value and function. You can

sense the perfect ergonomics of this knife when you have barely touched it, each finger easily finds its place on the rugged G-10 handle. The curved blade with the characteristic milled slots is made of 440C stainless steel, and features a notched thumb ramp for grip enhancement. The flipper allows for a quick and easy opening for both right-handed and left-handed users. The solid steel liner, with a thickness of 2.5mm, holds the blade securely in the open position. The notches in the liner provide easy handling. The pocket clip (tip-down carry) reflects the shape of the handle and completes the package. A strong pocket knife, not only an eye-catcher but also a reliable everyday companion. Blade length: 3 $\frac{3}{4}$ ". Overall length: 8 $\frac{7}{8}$ ". Weight: 7.8 oz. Item No. 01BO609 \$ 139.95

4 BOKER PLUS MINI VANQUISH. Jeremy Marsh from Michigan and his extraordinary designs are often far outside the mainstream knife market. Nevertheless, his creations are not merely show pieces, but highly functional and versatile tools for everyday chores. Thus we decided to add his Mini Vanquish, one of his most popular designs, to our renowned Boker Plus series of custom

collaborations. The breathtaking lines of this knife clearly illustrate that even in the vast knife market, novelties can still be found. The blade is made of 440C stainless steel and features a fine lateral satin finish. The brushed stainless steel bolsters and polished G-10 scales are mounted on blue anodized titanium liners, housing a spacer in a conventionalized shark fin design. Includes removable pocket clip (tip-up carry). Blade length: 3 $\frac{1}{8}$ ". Overall length: 7 $\frac{1}{2}$ ". Weight: 4.3 oz. Item No. 01BO150 \$ 116.95

5 BOKER PLUS KWAIKEN FOLDER. The Kwaiken Folder, a design of young knifemaker Lucas Burnley from New Mexico, was created after a long period of development. Burnley, whose most popular model is a fixed blade Kwaiken, wanted to translate his typically slim concept into a folding knife, without drastically changing the proportions. The result is a design that has fascinated us at first glance! The green canvas Micarta scales offer a superior grip without being unnecessarily rough. The slim and sleek blade is made of AUS-8 stainless steel, and performs extremely smoothly due to the IKBS bearings. This knife will surely prove that a slim handle doesn't have to compromise excellent ergonomics! Includes removable pocket clip. Blade length: 3 $\frac{1}{2}$ ". Overall length: 8 $\frac{3}{8}$ ". Weight: 4.2 oz. Item No. 01BO291 \$ 154.95



4
Boker Plus
Mini Vanquish.
\$ 116.95



Production
Prototype
Picture



BURNLEY

5
Boker Plus
Kwaiken Folder.
\$ 154.95

IKBS SYSTEM



6
Boker Plus
Epicenter.
\$ 212.00



Rexford
KNIVES

TITANIUM
FRAME LOCK



7
Boker Plus
Titan Drop.
\$ 67.95



6 BOKER PLUS EPICENTER. The Epicenter was designed by Todd Rexford, a young knifemaker from Colorado, who is a remarkable talent in the world of knife design. In addition to our successful Boker Plus line, this model represents a significant innovative step. Being the first titanium frame lock, this piece reaches a special status within our knife range. The massive titanium plates have a thickness of 5mm, and are contoured

three-dimensionally, offering outstanding performance and stability. Equally impressive is the blasted titanium surface and the finish of the handle (without protruding edges), which make the knife not only a sturdy usable knife, but also a beautiful collector's piece. The modified satin drop point blade is made of VG-10 steel, and features a removable double-sided thumb stud. The titanium pocket clip is reversible, allowing tip-up

or tip-down carry, and the lanyard hole adds convenience. An impressive synthesis of technology and design!
Blade length: 3½". Overall length: 8¾".
Weight: 6.5 oz.
Item No. 01B0170 \$ 212.00

7 BOKER PLUS TITAN DROP. A large but slender EDC and work knife, which can be carried comfortably even in a tighter pocket, due to the slim profile (handle thickness is less than ⅜"). The flat ground drop point blade, made of

440C stainless steel, can manage any cutting task with ease, and the bead blasted titanium handle combines minimum weight with maximum stability. The polished pocket clip is reversible, enhancing the versatility of this impressive piece. Blade length: 3¾". Overall length: 8¾". Weight: 4.5 oz.
Item No. 01B0188 \$ 67.95



BOKER PLUS

Rock solid.

FTZ

1 BOKER PLUS EXODUS. Andy Fitz has clearly proven his unmistakable instinct for balanced designs with his neck knife (model 02B0278). Now his new model, "Exodus," is playing in an entirely different league, yet still showing the same impressive skills of Andy Fitz. A sturdy everyday knife with tactical features, the Exodus convinces with high utility value, extremely stable construction and remarkable ergonomics. The full tang construction offers a blade thickness of 4.5mm, and the entire material thickness is maintained until 15mm before the tip. Due to the elaborately finished blade tip, the Exodus offers highly balanced cutting properties. The desert colored G-10 scales, attached to the tang with special screws, provide a superior grip. The perfectly fitted Kydex sheath can be adjusted with the included belt adapter. The blade is high performance 440C stainless steel with stonewash finish. Blade length: 4 1/8". Overall length: 8 1/2". Weight: 9.1 oz. Item No. 02B0520 \$ 123.95

2 BOKER PLUS BUSHCRAFT KNIFE. The simple and elegant design of the classic Bushcraft knives combines the artistic minimalism of this concept with the proven versatility in outdoor missions. The black Micarta handle provides a superior grip, and the characteristically deep sharpening of the 440C stainless steel blade provides outstanding stability. Includes a high quality black leather sheath with fire starter. Blade length: 4". Overall length: 8 3/4". Weight: 7.2 oz. Item No. 02B0296 \$ 77.95

3 BOKER PLUS VOX T-HAWK. Jesper Voxnaes is not only renowned for his ingenious knife designs - he has also created some impressive concepts in the area of tomahawks. The Vox T-Hawk is an example of his characteristic versatility and functionality. The sturdy construction is made of one single piece of SK5 carbon steel, which has been equipped with a resistant powder coating to protect it against corrosion. The cutting edge is hollow ground, to ensure extreme sharpness, and can master a great multitude of cutting chores. The G-10 scales have been threefold screwed and can be easily removed. Alternatively, a paracord handle wrapping can be fitted, which is included in olive and in orange. Openings in the tang reduce the weight and facilitate the fitting of the wrapping. All this in a fascinating

tool that clearly stands out with its unique design. Comes complete with nylon sheath. Thickness (without scales): 6mm. Overall length: 13 3/4". Head width: 7 3/4". Edge length: 3 1/2". Weight: 1.75 lbs. Item No. 09B0100 \$ 128.95

4 BOKER PLUS APPARO. Over the years, the knife market has seen numerous survival knives with hollow handles. Many of which can only be regarded as mere show pieces, due to a lack of stability. However, Newton Martin from Texas has developed a construction which is virtually indestructible, despite the screwed tang and handle. Extreme bending tests with this fixed blade have permanently deformed the blade before any kind of weak points were noticeable at the point of connection. International experts have been highly enthusiastic about the presentation of these custom knives, and now we are extremely proud to present this successful concept by Martin Knives as an exclusive Boker Plus product. The massive blade has a thickness of 6mm, and is made of high performance 440C stainless steel. The construction of the handle provides

1
Boker Plus
Exodus.
\$ 123.95

2
Boker Plus
Bushcraft
Knife.
\$ 77.95



3
Boker Plus
Vox T-Hawk.
\$ 128.95

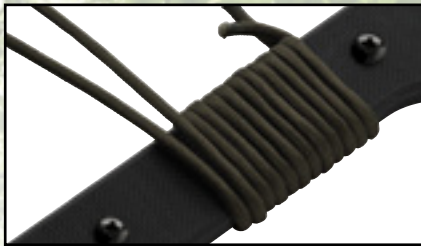

Includes two lengths of paracord (one olive green and one orange).

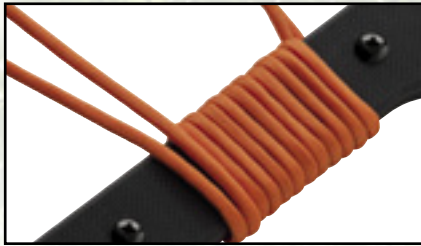

an entirely waterproof compartment inside the handle, for the safe storage of additional equipment (not included). The cord wrapping of the handle not only increases the grip but also provides several valuable meters of stable rope in case of an emergency. Due to the milled checkering, the handle also provides a safe amount of grip in various conditions without the wrapping. The prominent handguard enhances the secure handling of the knife. The handle and blade have a matte, non-reflective blasted finish. A knife without compromise, ready for any adventure! Includes a high quality black leather sheath. Blade length: 7". Overall length: 12 $\frac{3}{8}$ ". Weight: 1.1 lbs. Item No. 02B0001 \$ 195.95



4
Boker Plus
Apparo.
\$ 195.95

The milled checkering in the handle ensures a secure grip when the cording is removed.



BOKER PLUS





1
Boker Plus
BOB.
\$ 185.95

2
Boker Plus
Bobbi.
\$ 110.00



1 BOKER PLUS BOB. Another incredible design from Jesper Voxnaes. A monster of a knife, featuring an AUS-8 steel blade with a thickness of 7mm! The contoured, three-dimensional canvas Micarta handles offer a secure grip in any condition. The blade grind allows for a balanced cutting performance without reducing the heft. In clear terms, this knife is "built like a tank!" Includes Kydex sheath and Tek-Lok. Blade length: 3¾". Overall length: 7¾". Weight: 9.5 oz. Item No. 02B0273 \$ 185.95

2 BOKER PLUS BOBBI. The smaller, more compact version of the Boker Plus Bob (model 02B0273) from Jesper Voxnaes. Stout like its big brother, but the reduced size makes it more comfortable to carry. The handle scales are made of canvas Micarta, with a red fiber underlay. The 440C stainless steel boasts a fine satin finish, for an elegant look, and is 6.5mm thick, allowing

heavy duty use. This piece is ready for anything! Includes a premium grade leather sheath. Blade length: 2¾". Overall length: 6⅞". Weight: 5.9 oz. Item No. 02B0263 \$ 110.00

3 BOKER PLUS MTT. MTT stands for "Mega Tanto Tip." This design by Jesper Voxnaes combines the elements of the Kiridashi and tanto style blades. The extreme hollow blade grind guarantees precision cutting performance, even with the beefy 7mm thickness. The back of the MTT is completely flat with no scales, and offers excellent symmetry and grip. A versatile and extremely rugged knife for the toughest chores. The handles are machined G-10, and

the blade is high performance 440C stainless steel. Includes Kydex sheath. Blade length: 3". Overall length: 7¾". Weight: 8.8 oz. Item No. 02B0274 \$ 123.95

4 BOKER PLUS COLLECTION 2012. Bill Luckett from Weatherford, Texas, is well known for his extravagant Bowie knives. The Boker Plus Collection 2012 is a very typical Luckett design, and enthralls from the first look with its dynamic appearance. The amazing design lines and his breathtaking blade grinds make his custom knives desired collector's pieces. Bill Luckett generally works free hand, without master plates or fixations, so each of his knives is a

truly unique piece and never duplicates another. The extravagant grind of the mirror polished blade presented a great challenge for the Boker team, and makes the Boker Plus Collection 2012 an exceptional presentation piece. The large handguard and the pommel are polished as well, and are set with several fiber layers, which frame the ergonomic black Micarta handle. We use 440C stainless for the blade steel, which is the standard for the Boker Plus Collection series. The Boker Plus Collection 2012 - a knife which makes not only a great collector's piece in your showcase, but also a Bowie knife which does not step back from any challenge. Strictly limited to just 1,999 pieces worldwide. Comes complete with a high quality leather sheath, certificate of authenticity, and collector's presentation box. Blade thickness: 6mm. Blade length: 8¼". Overall length: 13⅝". Weight: 12.2 oz. Item No. 02B02012 \$ 199.95

5 BOKER PLUS COLLECTION 2013. E. Scott McGhee is an American Bladesmith (ABS) who lives and works in Southeastern North Carolina. Scott learned the art of bladesmithing at Penland School of Crafts at the age of 17, and has worked at a coal fired forge on and off since 1981. In August



3
Boker Plus
MTT.
\$ 123.95

4
Boker Plus
Collection
2012.
\$ 199.95



NEW

5
Boker Plus
Collection
2013.
\$ 199.95



BOKER PLUS
COLLECTION 2013

6
Boker Plus
Collection
2011.
\$ 199.95



BOKER PLUS

of 2009, he built a gas fired forge and began his bladesmithing in earnest. He is currently on a quest to obtain ABS Master Certification and begin knife making full time. The Boker Plus Collection knife for 2013 is based on his famous Copperhead custom piece. The blade shape and silhouette is typical of McGhee's designs. To guarantee the best cutting performance, the blade is made of 440C premium stainless steel with an attractive two-tone

finish. The comfortably shaped handle is made of brown Micarta, and features artistic mosaic pins. The stainless steel handguard prevents slipping, and completes this heavy duty piece. Includes a premium brown leather sheath, collector's box and certificate of authenticity. Strictly limited to just 999 pieces worldwide. Blade length: 8". Overall length: 13 3/8". Weight: 15.1 oz. Item No. 02B02013 \$ 199.95

6 BOKER PLUS COLLECTION 2011. Danish knifemaker Jesper Voxnaes is legendary for his unique tactical designs. The Boker Plus Collection 2011 shows, unmistakably, his signature. The massive blade with the two-tone satin finish features a curvy cutting edge and a massive blade spine, with a thickness of more than 1/4". 3-D sculptured Micarta handle slabs are mounted on the full tang, providing a stunning effect. The shape and the grooves provide secure handling and an excellent grip. The blade is made of 440C stainless

steel, and provides outstanding edge retention. Comes complete with a high quality leather sheath. Strictly limited to just 999 pieces worldwide. Blade length: 6". Overall length: 11 1/2". Weight: 13.2 oz. Item No. 02B02011 \$ 199.95





1
Boker Plus
CLB Karambit.
\$ 46.95

2
Boker Plus
Baby Bat.
\$ 61.95

Heavin Forge

3
Boker Plus
Bat Knife.
\$ 67.95

1 BOKER PLUS CLB KARAMBIT. Chad goes Karambit! This Chad Los Banos design has it all - framelock mechanism, G-10 handle offering remarkable carrying comfort, and a spring-assisted carabiner. The blade is made of 440C stainless steel, titanium coated, and provides outstanding cutting performance with its recurved tanto style shape. Includes reversible pocket clip. Blade length: 2⁷/₈". Overall length: 7³/₄". Weight: 5 oz. Item No. 01B0580 \$ 46.95

2 BOKER PLUS BABY BAT. The smaller version of the successful Bat Knife (below). Offering the same exciting design of Heavinforge, this compact model features a 440C stainless steel blade and rugged G-10 handle scales. Includes pocket clip. Blade length: 3¹/₈". Overall length: 7¹/₄". Weight: 3.6 oz. Item No. 01B0431 \$ 61.95

3 BOKER PLUS BAT KNIFE. The first Boker Plus design from South Africa by Kevin and Heather Harvey, or "Heavin" as they are recognized

by many. This radial hawkbill blade design is a true representation of their unique grinding methods that offer a blade of extreme sharpness. The G-10 handle scales are designed to melt into your hands. The blade is made of 8Cr13MoV steel, and features a bead blast finish. Includes lanyard and pocket clip. Overall length: 8¹/₄". Blade length: 3³/₄". Weight: 6.2 oz. Item No. 01B0430 \$ 67.95

4 BOKER PLUS NOPAL. Newton Martin is a young knifemaker from Texas, known for rugged fixed blades, who recently started designing and making folding knives as well. His model "Nopal" got its name from the Texan word for the cactus plant, whose leaves replicate the shape of the closed knife. The stable Wharncliffe blade has a chisel grind, offering extraordinary strength and sharpness. The straight cutting edge allows extremely precise cuts and perfect tip control. Steel liner and textured G-10 scales in combination with the deep finger choils and notches provide a secure grip and excellent ergonomics. The blade is made

of 440C stainless steel, satin finished, and locks with a sturdy liner lock mechanism. Includes removable pocket clip. Blade length: 2¹/₈". Overall length: 5¹/₂". Weight: 3 oz. Item No. 01B0180 \$ 54.95

5 BOKER PLUS ELEGANCE. An elegant gentleman's knife, with precise production features. The handle is made of two massive titanium slabs with integral bolsters. Milled pockets in the titanium bare the G-10 inlays and provide secure handling, as well as a noble appearance. The locking mechanism is released by the push button (non-automatic) integrated into the titanium scale. The 440C stainless steel blade has an effective hollow grind and an appealing two-tone finish. The removable pocket clip completes the package. Blade length: 2⁵/₈". Overall length: 6". Weight: 2 oz. Item No. 01B0027 \$ 89.95

6 BOKER PLUS CARBON. This pocket knife makes a statement, with its slim profile and impressive choice of materials. Contoured carbon fiber handle scales, mounted on bronze colored titanium liners, and the two-tone blade make this knife an elegant companion for everyday use. The reliable push button lock (non-automatic) holds the 440C stainless steel blade securely in the open position. Does not have pocket clip. Blade length: 2⁷/₈". Overall length: 6⁷/₈". Weight: 2.5 oz. Item No. 01B0026 \$ 108.95

7 BOKER PLUS TITANIUM BLUES. This smaller version of the Carbon (model 01B0026) features massive titanium slabs with integrated bolsters. In the precisely milled pockets, inlays are carbon fiber and create a stunning contrast to the blue anodized titanium. The ultra modern push button lock (non-automatic) gives this knife a distinctively elegant, yet technical appearance. The blade steel is high performance 440C stainless. Does not have pocket clip. Blade length: 2¹/₂". Overall length: 6". Weight: 2 oz. Item No. 01B0025 \$ 108.95



4
Boker Plus
Nopal.
\$ 54.95



5
Boker Plus
Elegance.
\$ 89.95



6
Boker Plus
Carbon.
\$ 108.95



7
Boker Plus
Titanium Blues.
\$ 108.95



8 BOKER PLUS 3000 LIGHTWEIGHT. Our Boker Solingen model 3000 has been popular for many years now, especially for hunting and the outdoors. For everyday carry, many users prefer a more slim and lightweight knife, and our new Boker Plus 3000 Lightweight is the answer. The titanium bolsters frame the contoured black G-10 scales, and the versatile drop point 440C stainless steel blade displays an attractive brushed finish. Another new feature is the removable pocket clip, which

allows for comfortable and discreet carry. An ageless knife classic, made of modern materials. Blade length: 3⁵/₈". Overall length: 8¹/₄". Weight: 5 oz. Item No. 01B0187 \$ 70.95

01B0187, shown above), but with handsome maple burl wood handle scales. Blade length: 3⁵/₈". Overall length: 8¹/₄". Weight: 5 oz. Item No. 01B0087 \$ 90.95

9 BOKER PLUS 3000 LIGHTWEIGHT MAPLE BURL. Same features and specifications as the original (model

8
Boker Plus 3000
Lightweight.
\$ 70.95



9
Boker Plus 3000
Lightweight
Maple Burl.
\$ 90.95



BOKER PLUS

1
Boker Plus
Anti-MC.
\$ 89.95

2
Boker Plus
Anti-Grav.
\$ 96.95

3
Boker Plus
Ceramic
Gamma.
\$ 65.95

4
Boker Plus
Cera-Tac.
\$ 87.95

RAZOR SHARP
CERAMIC BLADES!

1 BOKER PLUS ANTI-MC. The unique combination of the most modern materials grants an exceptional position in the knife market. The blade is made of hi-tech ceramic, which is 100% non-magnetic and provides outstanding edge retention and corrosion resistance. The handle is made of lightweight,

durable, corrosion resistant titanium, and features an integral frame lock mechanism. A pocket knife with truly unique qualities! Includes pocket clip and lanyard hole for secure handling. Blade length: 3¼". Overall length: 7¾". Weight: 2.5 oz. Item No. 01B0035 \$ 89.95

2 BOKER PLUS ANTI-GRAV. The companion to the Anti-MC also features a super sharp ceramic blade and unbelievably, an even lighter carry!

The handle is made of carbon fiber, which provides not only incredibly little weight, but also outstanding stability and elegance. Includes pocket clip and lanyard hole. Frame lock mechanism. Blade length: 3¼". Overall length: 7¾". Weight: 2.1 oz. Item No. 01B0036 \$ 96.95

3 BOKER PLUS CERAMIC GAMMA. Small, flat and extremely sharp - our ceramic Gamma pocket knife performs admirably, with its sharp and rust proof ceramic blade. The G-10 scales provide grip and stability. Features a sturdy liner lock mechanism. Does not have a pocket clip. Blade length: 2½". Overall length: 5½". Weight: 1.8 oz. Item No. 01B0088 \$ 65.95

4 BOKER PLUS CERA-TAC. As the successor of our legendary Boker Infinity model, one of the pioneers in the field of tactical pocket knives with ceramic blades, we proudly present the new Cera-Tac. The indestructible machined G-10 scales cover the rugged stainless steel frame. The absolutely non-magnetic and corrosion resistant ceramic blade ensures maximum cutting performance. An exceptional piece for a variety of uses! Liner locking mechanism and reversible pocket clip for tip-up or tip-down carry. Blade length: 3⅝". Overall length: 8⅜". Weight: 4.5 oz. Item No. 01B0037 \$ 87.95

5 BOKER PLUS JC1. This pocket knife is dedicated to Chad Los Banos's daughter, Jacy. Similar to the ergonomics of the popular Edit model, the JC1 is a compact and durable folding knife. The short, broad blade is titanium coated, and, in conjunction with the generously sized handles, provides extremely powerful cuts. The flat design allows superior comfort. The blade is high performance 440C stainless steel, and locks securely with the frame lock mechanism. Also features sturdy G-10 handle scales and a reversible pocket clip for tip-up or tip-down carry. Blade length: 2". Overall length: 5¼". Weight: 3.5 oz. Item No. 01B0534 \$ 51.95

6 BOKER PLUS CLB XS. The new XS scores with the one-hand opening option, a slip joint construction, double G-10 scales and an ambidextrous clip. The titanium coated blade is made of 440C stainless steel and features a notched thumb ramp, while the textured handle scales provide optimum control. The deep index finger choil allows different grip options for versatility. A perfect companion - anywhere, anytime. Blade length: 3". Overall length: 7⅞". Weight: 4 oz. Item No. 01B0536 \$ 46.95

7 BOKER PLUS CLB DIREKT. This subhilt handle design provides an unbeatable grip security. The forward finger guard works as a flipper for deploying the blade fast and easy, while the ambidextrous thumbstuds allow a more discreet opening. The double sided milled G-10 scales with their special Boker-Grip surface support the secure grip feeling. The four-way reversible clip allows various carrying options, based on personal preference. A reliable liner lock holds the titanium-coated 440C blade in the open position. Overall length: 8¾". Blade length: 3⅝". Weight: 4.2 oz. Item No. 01B0570 \$ 75.95

8 BOKER PLUS RESURRECTION GEN 2. We are happy to welcome Mississippi knifemaker Jim Burke to our international design team.

5
Boker Plus
JC1.
\$ 51.95



6
Boker Plus
CLB XS.
\$ 46.95



7
Boker Plus
CLB Direkt.
\$ 75.95



BOKER PLUS

His experiences as a police officer, SWAT team member and CQB trainer give him a solid base for his knife designs. This new generation Resurrection 2 was modified extensively, offering improved speed and enhanced operability, and the new G-10 scales offer an even better grip. The new aluminum back spacer optimizes the balance of the knife, and the reversible pocket clip allows tip-up or tip-down carry. The bellied recurve blade, made of 440C stainless steel, has an enormous cutting power, yet guarantees ultimate stability with its

4mm thickness. Ambidextrous thumb studs, liner locking mechanism. A big boy liner lock folder for those preferring a handful! Blade length: 3¾". Overall length: 9". Weight: 7.9 oz. Item No. 01B0412 \$ 103.95

9 BOKER PLUS S2. Sniper Bladeworks - stands for the design of Lance Abernathy, former SWAT member, and the handiwork of Jody Muller, knifemaker for the past 20

years. This team designs tactical folders of a slightly different kind. The S2 is unique due to its wide, completely flat ground blade, which provides phenomenal cutting performance. The slim handle sits comfortably in your hand and guarantees perfect control. In addition, the thumb ramp and the flipper protect against slipping of the finger. The structured G-10 scales on

steel liners offer maximum stability and a very secure grip. The reversible pocket clip, which allows tip-up or tip-down carry, and the lanyard hole complete the package. The slim profile provides the highest degree of carry comfort. Features a high performance 440C stainless steel blade and liner locking mechanism. Blade length: 4". Overall length: 8¾". Weight: 5 oz. Item No. 01B0160 \$ 85.95

8
Boker Plus
Resurrection
Gen 2.
\$ 103.95



9
Boker Plus S2.
\$ 85.95





1
Boker Plus
Trigonaut.
\$ 103.95



2
Boker Plus
Rampage.
\$ 144.95

RJ MARTIN



3
Boker Plus
Besh-Wedge®
Neck Knife.
\$ 41.95



1 BOKER PLUS TRIGONAUT. David Mosier, Missouri custom knifemaker, is well known for his tactical fixed blades. This piece, with its modified Wharncliffe style blade made of Sandvik 12C27 steel, shows a soft upward curved cutting edge, which improves EDC versatility without losing its character. The milled two-tone Micarta handle offers excellent ergonomics, along with a stunning appearance. Sheath included. Blade length: 3 1/4". Overall length: 7 1/4". Weight: 5.5 oz. Item No. 02B0280 \$ 103.95

2 BOKER PLUS RAMPAGE. The Rampage, designed by famous knifemaker R. J. Martin, is a purely tactical knife. 4 3/4" of super-aggressive, deep hollow ground 440C stainless steel blade meshed with a super-

ergonomic handle. Lock your hand into the deep finger grooves in the durable black Micarta handle and serrated thumb ramp in either a straight or a reverse grip. You've never held anything like it! The Rampage comes with a custom injection-molded ABS sheath, which allows almost infinite carry options on belts, clothing or gear. Overall length: 9 1/2". Weight: 5.8 oz. Item No. 02B0110 \$ 144.95

3 BOKER PLUS BESH-WEDGE® NECK KNIFE. Canadian knifemaker Brent Beshara is known for his unique blade style called the Besh-Wedge®, which uses the full thickness of blade material completely up to the blade tip, providing maximum stability. The Applegate-Fairbairn version of the Besh-Wedge® (shown on page 29) has already hit the

knife scene with a bang. The new Neck Wedge transfers this concept to the world of the comfortable-to-carry back up knives. The blade steel is 440C stainless, getting optimum corrosion resistance by a titanium coating. Grip enhancing G-10 scales and a Kydex sheath complete the package and provide the demanding user with a professional tactical tool. Blade length: 4 1/4". Overall length: 7 1/4". Weight: 2.5 oz. Item No. 02B0275 \$ 41.95

4 BOKER PLUS FEATHERWEIGHT. The neck knife Featherweight, designed by Doug Hartsook, is made completely of carbon fiber. Although such a blade can never replace a steel blade, this knife, weighing less than one ounce, is a reliable tool for emergency situations and will not burden you with a heavy weight. It is not intended to be an everyday tool for

frequent use or for executing fine cutting tasks. Includes a Kydex sheath and ball chain. Blade length: 2 7/8". Overall length: 6". Weight: 0.4 oz. Item No. 02B0279 \$ 51.95

5 BOKER PLUS CLB EDIT. With an overall length of 5 3/8" and a blade length of just over 2", the ergonomic design of this knife provides a super secure grip, enhanced by the notched thumb ramp on the blade spine. The lanyard (included) makes it easy to draw the knife, and also works as a handle extension for the pinky. The blade thickness of 1/8" reduces the weight without compromising the sturdiness. The ball chain (included) allows neck knife carry, or the Zytel sheath can be carried on the belt with a small Tek-Lok, model 09B0506 (not included). 440C stainless steel blade with titanium-based coating. Item No. 02B0020 \$ 54.95



4
Boker Plus
Featherweight.
\$ 51.95



5
Boker Plus
CLB Edit.
\$ 54.95

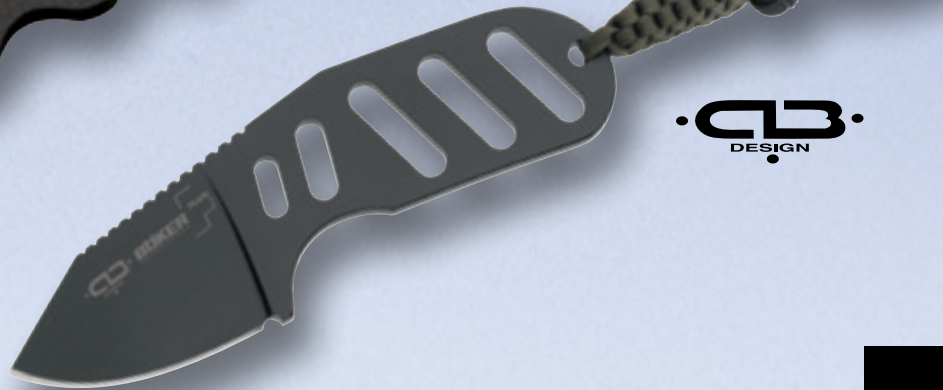

6
Boker Plus
Pocket Bowie.
\$ 54.95



7
Boker Plus
Grasshopper.
\$ 46.95



8
Boker Plus
PSK.
\$ 103.95



6 BOKER PLUS POCKET BOWIE. The Pocket Bowie is a very popular Tom Krein knife. The short, stout blade features a hollow grind and deals with every cutting task with this versatile blade shape. The handle features contoured G-10 scales with white fiber layers and fits the hand perfectly. The index finger choil enhances the secure grip. Blade steel is high performance 440C stainless. Comes with a Tek-Lok compatible Kydex sheath by Tom Krein, with ball chain (Tek-Lok not included). Blade length: 2½". Overall length: 5¾". Weight: 2.2 oz. Item No. 02B0266 \$ 54.95

7 BOKER PLUS GRASSHOPPER. With a weight of just about one ounce, the Grasshopper from Tom Krein is extremely

lightweight and provides great carry comfort. The skeleton handle offers superior ergonomics and well balanced handling in various grip styles. The index finger choil enhances the positive grip. A maximum of utility with a minimum of dimension characterizes the Grasshopper. The blade steel is 440C stainless, titanium-coated. Comes with a Kydex neck sheath (by Tom Krein) and ball chain. Blade length: 1⅞". Overall length: 4¾". Weight: 1 oz. Item No. 02B0265 \$ 46.95

8 BOKER PLUS PSK. Arkansas custom knifemaker Tom Krein has made his mark with the Grasshopper and the Pocket Bowie in the Boker Plus series. His Personal Survival Knife (PSK) steps it up a notch and provides a nearly indestructible survival and outdoor tool with invaluable service. The blade is made of 12C27 steel, and the massive thickness of 4.7mm provides, in combination with the unique blade grind, tremendous cutting characteristics with enormous stability. The G-10 scales, red fiber layers and the

oversized lanyard hole enhance the look and function. Includes Kydex sheath by Tom Krein, and Tek-Lok. Custom quality at the right price! Blade length: 3". Overall length: 6½". Weight: 6 oz. Item No. 02B0267 \$ 103.95



BOKER PLUS

1
Boker Plus
CK-1 Rescue.
\$ 51.95

1 BOKER PLUS CK-1 RESCUE. U.S. outdoor and kayak specialist Abe Elias designed this emergency knife, based on his specific experiences. It is an essential tool in every situation in which quick aid for yourself or others can be a matter of survival. Bright yellow handle scales (detachable), made of Zytel, make the knife visible in any situation, and provide a firm and secure grip, even with wet hands or gloves. The straight cutting edge prevents the material being cut from slipping off the edge, maximizing the effectiveness. Partial serrations behind the tip make it easy to cut belt or webbing without working the whole blade close to the body, and the sheepfoot design with the round tip prevents injury. The blade steel is 440C stainless, titanium coated. Includes a Kydex sheath and Tek-Lok. Blade length: 3½". Overall length: 7¾". Weight: 3.5 oz. Item No. 02B0284 \$ 51.95

2 BOKER PLUS STEELMARINER. This versatile knife is not only ideal for diving, but also all around outdoor use. The titanium coated 440C stainless steel blade provides the best of both worlds, an aggressive serrated edge and corresponding plain edge. The handle is durable G-10 with oval cutouts for weight reduction and tie offs. Includes a Kydex sheath and Tek-Lok. Blade length: 4". Overall length: 8". Weight: 6.5 oz. Item No. 02B0285 \$ 61.95

3 BOKER PLUS DOZIER ANCHORAGE PRO SKINNER GREEN. Legendary custom knifemaker, Bob Dozier, collaborates with Boker Plus for this exceptional piece, which combines his characteristic keen sense of functionality

with an aesthetic appearance. This model is an interesting modification of Dozier's legendary hunting knife, the Yukon Pro Skinner, with a hollow ground blade that is extremely fine ground, and features artistic file work on the back - which doubles as a slip-resistant thumb ramp. The blade is made of AUS-8 stainless steel with a full tang for extreme strength. The ergonomically shaped green canvas Micarta handle features a lanyard hole and is set to the tang with six rivets. Comes complete with a leather sheath. Blade length: 3½". Overall length: 8". Weight: 4.9 oz. Item No. 02B0253 \$ 92.95

4 BOKER PLUS DOZIER ANCHORAGE PRO SKINNER. Same specifications as model 02B0253 (above), but with a black Micarta handle. Item No. 02B0250 \$ 92.95

5 BOKER PLUS DOZIER ARKANSAS TRAVELER. Similar to the Anchorage Pro Skinner (above), but with a versatile drop point blade and elegant olive wood handle. Includes leather sheath. Blade length: 2¾". Overall length: 6¾". Item No. 02B0251 \$ 78.95

6 BOKER PLUS ROLD. With the Rold from VoxKnives, we have a new player on the Boker Plus team, which fills the void for a real camp knife. The massive full tang construction with mounted G-10 scales provides, in combination with the extremely tough D2 tool steel,

3
Boker Plus Dozier
Anchorage Pro
Skinner Green.
\$ 92.95

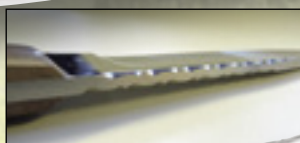

4
Boker Plus Dozier
Anchorage Pro
Skinner.
\$ 92.95



5
Boker Plus
Dozier Arkansas
Traveler.
\$ 78.95





6
Boker Plus
Rold.
\$ 185.95



7
Boker Plus
Ginger Fighter.
\$ 170.95



extraordinary ruggedness with the flat grind, offering outstanding cutting capabilities. The rivet tubes not only reduce the weight of the knife, but also allow the addition of a lanyard. The additional index finger choil gives the ability to grab the handle "short" for better control in fine and precise cutting tasks, while the notched thumb ramp and the dove tail shaped handle butt maximize the control in chopping and other heavy duty chores. The red fiber layers add a subtle contrast to the handle. The very well balanced design clearly shows the long years of experience from Jesper Voxnaes regarding the demands of hunting and the outdoors. Includes Kydex sheath and Tek-Lok. Blade length: 6". Overall length: 11". Weight: 10.5 oz. Item No. 02B0272 \$ 185.95

7 BOKER PLUS GINGER FIGHTER. We needed no convincing after we handled this Todd Begg design - it is

the ultimate fighter. The hefty 6mm thick, stonewashed 440C stainless steel bowie style blade will provide results in all conditions, be it a field or fighting knife. The milled G-10 scales offer superior grip, while the pronounced finger guard and thumb ramps ensure grip and safety. Includes a Kydex sheath and Tek-Lok. Blade length: 6 1/4". Overall length: 11 1/8". Weight: 12.5 oz. Item No. 02B0600 \$ 170.95

8 BOKER PLUS VALKYRIE. A modern interpretation of the classic Vietnam bowies, from Boker Plus. The blade features a satin finish going off into two different directions (for a two-tone

finish), has an impressive thickness of 6 mm, and is made of 440C stainless steel with excellent edge-holding capability. The crossguard is made of stainless steel and offers plenty of safety, even under rugged field use. The extensively ground Micarta handles are ergonomically shaped for a comfortable and secure grip, and contain a red fiber layer underneath. The handles are fastened to the tang by the use of mosaic pins, which are ordinarily only seen on custom knives due to costly production, and create a unique appearance. A must-have for the collector! With its approved concept and sturdy dimensions it can also be used as a reliable outdoor knife for a variety of cutting chores. Includes lanyard hole and a premium genuine leather sheath. Blade length: 7 1/4". Overall length: 12 2/3". Weight: 16.4 oz. Item No. 02B0160 \$ 154.95

8
Boker Plus
Valkyrie.
\$ 154.95



BOKER PLUS

Tough and rugged.

NEW

MANARO →



1
Boker Plus
SM-10.
\$ 119.95

2
Boker Plus
TUF.
\$ 56.95



cutting performance. The finely checkered surface at the end of the handle and the index finger choil support various grip positions. The satin finished blade is crafted of high performance 440C stainless steel. Includes a premium leather sheath with metal belt clip. Blade length: 4¼". Overall length: 8". Weight: 6.1 oz. Item No. 02BO450 \$ 119.95

2 BOKER PLUS TUF. A design by Boker's own Terry Trahan, the TUF (Terry's Urban Fixed Blade) is a versatile EDC with a wide range of applications. The deep finger grooves and the angled end of the handle provide maximum grip, and the high polish 440C stainless steel blade has a moderate thickness of 3.1mm. A magnet holds the knife securely in the innovative leather sheath, by Chuck Pippin, and has a special strap for carrying in the waistband. The handles are crafted of sturdy cocobolo wood. Blade length: 4¾". Overall length: 8¾". Weight: 4.8 oz. Item No. 02BO295 \$ 56.95

3 BOKER PLUS FITZ STAG. Due to the amazing success of the carbon fiber neck knife from Andy Fitz (model 02BO278, below), we proudly present this classic version, featuring genuine stag handles. The versatile blade shape

is suitable for everyday use, outdoors, or even on a hunting trip, and is crafted of 440C stainless steel. Includes a premium leather sheath. Blade length: 2½". Overall length: 5½". Weight: 2.7 oz. Item No. 02BO288 \$ 79.95

4 BOKER PLUS FITZ NECK KNIFE. This smart little neck knife immediately caught our attention. It provides an excellent hand grip despite its compact design. The slightly recurved 440C stainless steel blade guarantees outstanding cutting properties. The handle scales are contoured carbon fiber, reducing the weight and increasing the carry comfort. Includes a Kydex sheath and ball chain. Blade length: 2½". Overall length: 5½". Weight: 2.2 oz. Item No. 02BO278 \$ 74.95

5 BOKER PLUS NIPPON NECKER. The size of the Nippon Necker by Jesper Voxnaes makes it a truly versatile piece, as a neck knife or as a small belt knife. The straight spine provides a comfortable bellied blade, and the green Micarta handle scales with red fiber layers provides a sturdy grip. The blade is high performance 440C stainless steel with a two-tone finish. Blade length: 3". Overall length: 6½". Weight: 2.7 oz. Item No. 02BO276 \$ 92.95

1 BOKER PLUS SM-10. Sal Manaro, custom knifemaker from Holbrook, NY, brings us this eye-catching piece, featuring a dynamic blade that harmonizes perfectly with the characteristically checkered G-10 handle scales. Despite its sleek and flat profile, this knife feels extraordinarily comfortable in the hand, and the slightly recurved blade offers outstanding

F

NEW



3
Boker Plus
Fitz Stag.
\$ 79.95

FITZ



4
Boker Plus Fitz
Neck Knife.
\$ 74.95



5
Boker Plus
Nippon Necker.
\$ 92.95



6
Boker Plus
Rambler.
\$ 46.95

LHOTAK
DESIGN

6 BOKER PLUS RAMBLER. This design, by Austrian designer Raimund Lhotak, stands out with its unconventional yet appealing appearance. Due to the slim handle and the generously dimensioned thumb ramp, the compact Rambler rests comfortably in your hand. The black and blue G-10 scales and the satin finished blade create an attractive, classy look. The blade is made of high performance 440C stainless steel. Includes a leather sheath with belt loop. Blade length: 2¾". Overall length: 5⅜". Weight: 2 oz. Item No. 02BO182 \$ 46.95

7 BOKER PLUS RAMBLER STAG. Due to the tremendous success of the original Rambler (model 02BO182, above), we bring you this new version, featuring rugged stag handles. Includes a premium leather sheath. Blade length: 2¾". Overall length: 5⅜". Weight: 2.5 oz. Item No. 02BO183 \$ 69.95

NEW



7
Boker Plus
Rambler Stag.
\$ 69.95

BÖKER PLUS

BOKER PLUS

Innovation Plus.



1
Boker Plus Newton
Martin K-Bit.
\$ 51.95



2
Boker Plus
Rhino Calf.
\$ 35.95



3
Boker Plus
Magyar.
\$ 51.95

1 BOKER PLUS NEWTON MARTIN K-BIT. The name says it all. A Newton Martin design for an ultra compact Karambit. This design makes the knife a very compact companion, which can be worn discreetly using the accompanying Kydex sheath and ball chain. The handle opening provides many options and makes room for the fingers to ensure the most secure grip. Or use the entire hand around the ring for other applications, as the circular notches will provide optimum grip, and also allow for a winding of paracord. The 5mm thick blade is made of high performance 440C stainless steel, titanium coated. This knife makes for a truly versatile companion, any way you choose to use it! Blade length: 1 $\frac{5}{8}$ ". Overall length: 4". Weight: 1.5 oz. Item No. 02B0030 \$ 51.95

2 BOKER PLUS RHINO CALF. The new, extremely compact and handy Rhino Calf builds on the success of the Boker Plus Rhino, with an extremely versatile blade shape. The deep forefinger and thumb ribbing on the back of the blade allows a secure grip and sure control. The high performance 440C stainless steel blade boasts a stonewash finish. Comes complete with a Kydex sheath and ball chain. Blade length: 1 $\frac{3}{4}$ ". Overall length: 3 $\frac{3}{8}$ ". Weight: 1 oz. Item No. 02B0259 \$ 35.95

3 BOKER PLUS MAGYAR. This sturdy neck knife from Péter Farkas of Hungary offers exceptional carry comfort due to its flat profile, as well as excellent grip and handling. Crafted of 440C stainless steel, with a rustic finish. Add your own paracord wrapping for a custom look! Includes a Kydex sheath and ball chain. Blade length: 2". Overall length: 4 $\frac{1}{4}$ ". Weight: 2 oz. Item No. 02B0281 \$ 51.95

4 BOKER PLUS TOUCAN. Hard to believe that such a small tool can offer such a wide variety of uses, while providing outstanding ergonomics. The Toucan, designed by Jared Price, features not only a rugged blade made of 440C stainless steel, but also a bottle opener, nail puller/mini prybar, and a screwdriver. The compact Kydex sheath allows neck carry or comfortable pocket carry. Blade length: 1". Overall length: 3". Weight: 1.3 oz. Item No. 02B0282 \$ 39.95

5 BOKER PLUS CERA-NECK. This neck knife, made completely of ceramic, is not only corrosion resistant but also provides outstanding edge holding ability. The paracord wrapped handle and Kydex sheath make it comfortable and easy to carry. Blade length: 1 $\frac{5}{8}$ ". Overall length: 4 $\frac{1}{4}$ ". Weight: 1.3 oz. Item No. 02B0670 \$ 46.95

6 BOKER PLUS YURCO. Mickey Yurco from Ohio is known for his compact but effective cutting tools. The Yurco, with its bellied edge, not only fascinates hunters, it also has its place in everyday life with its impressive versatility. The strong full tang construction and Micarta handle scales make it incredibly comfortable in the hand, and the upswept tip and finely honed, satin finished 440C stainless steel blade allows for extremely precise cutting. The deeply checkered thumb ramp supports the superior grip. Includes a Kydex sheath with belt adapter. Blade length: 3". Overall length: 6 $\frac{3}{8}$ ". Weight: 3.8 oz. Item No. 02B0521 \$ 74.95

7 BOKER PLUS MEGA MINI. The Boker Plus Mega Mini is based on a concept of Jesper Voxnaes, for a one-finger handled neck knife. One finger seemed a little too minimalistic for us, so we requested a two-finger version. The result is this impressive piece, featuring excellent ergonomics allowing a firm and secure grip, while the flat design offers exceptional carry comfort. Includes a Kydex sheath and ball chain. Blade length: 2". Overall length: 4 $\frac{1}{4}$ ". Weight: 1.4 oz. Item No. 02B0258 \$ 39.95

8 BOKER PLUS TUNNEL RAT. The small but sturdy Tunnel Rat was designed by Jimmy Burke from Mississippi, father of Jim Burke, who has already collaborated with us on several projects. The three-finger handle, with its deep finger recesses, lies comfortably in your hand. The bicolor G-10 scales in combination with the stonewash finish give the knife a truly unique look. The blade steel is high performance 440C stainless. Comes complete with a compact leather sheath. Blade length: 3 $\frac{1}{8}$ ". Overall length: 6 $\frac{1}{8}$ ". Weight: 5.8 oz. Item No. 02B0700 \$ 103.95



4
Boker Plus
Toucan.
\$ 39.95



5
Boker Plus
Cera-Neck.
\$ 46.95



6
Boker Plus
Yurco.
\$ 74.95

7
Boker Plus
Mega Mini.
\$ 39.95



8
Boker Plus
Tunnel Rat.
\$ 103.95



BOKER PLUS

Form, Function & Reliability.



1
Boker Plus
Gnome Stag.
\$ 82.95



2
Boker Plus
Rhino Stag.
\$103.95



3
Boker Plus
Rhino.
\$ 85.95

is 12C27, and the handle is crafted of rugged stag. Includes black lanyard and leather sheath. Blade length: 3". Overall length: 6". Weight: 3.8 oz. Item No. 02B0269 \$ 103.95

5 BOKER PLUS GNOME OLIVE. The pristine version of our tremendously successful Gnome by Jesper Voxnaes. This new model features beautifully grained olive wood scales and red fiber underlays. The blade is made of 440C stainless steel. Comes complete with a leather belt sheath. Blade length: 2". Overall length: 4". Weight: 2 oz. Item No. 02B0238 \$ 49.95

steel is 12C27. Includes a quality leather belt sheath. Blade length: 2". Overall length: 4". Weight: 2 oz. Item No. 02B0268 \$ 82.95

3 BOKER PLUS RHINO. Same features and specifications as the stag model shown above (item 02B0269), but with contoured G-10 handle scales. Includes black lanyard and Kydex sheath, Tek-Lok compatible (Tek-Lok not included). Blade length: 3". Overall length: 6". Weight: 3.8 oz. Item No. 02B0271 \$ 85.95

6 BOKER PLUS SANYOUGO. Cooking is everywhere! The SanYouGo by Jesper Voxnaes is a classic Santoku reduced to the essentials. This concept allows the user to be closer to the action, with the forefinger on the back of the blade, and the short, arched handle in the palm, held by the middle and ring fingers, offering maximum control. The rugged handle scales are G-10 with a red fiber layer, and the blade is 12C27 steel for ultimate sharpness. Includes a leather sheath (without belt loop). Perfect for camping, picnicking, you name it - the ultimate outdoor companion! Blade length: 3 3/8". Overall length: 5 7/8". Weight: 2.5 oz. Item No. 03B0050 \$ 72.95

4 BOKER PLUS GNOME. Same features and specifications as the stag model (item 02B0268), but with contoured green canvas Micarta handles. Includes a Kydex sheath. Blade length: 2". Overall length: 4". Weight: 2 oz. Item No. 02B0270 \$ 54.95

1 BOKER PLUS GNOME STAG. We are very proud to present the VoxKnives Gnome Stag, as a Boker Plus exclusive design. This neck knife from Jesper Voxnaes will captivate you with its ultra compact design and carry comfort. The rugged stag handle scales provide a secure and comfortable grip, even with a knife of this compact size, and present an attractive contrast with the bright red fiber layers. Blade

2 BOKER PLUS RHINO STAG. A knife that you will just need to own. The Rhino has already been a very successful handmade custom piece from Jesper Voxnaes. This Boker Plus version, with the same elite blade lines, creates a curved cutting edge and offers a huge amount of utility for a variety of tasks. From outdoors to carving, from preparing game to a modern EDC - the Rhino does it all! Blade steel

4
Boker Plus
Gnome.
\$ 54.95



5
Boker Plus
Gnome Olive.
\$ 49.95



6
Boker Plus
Sanyougo.
\$ 72.95

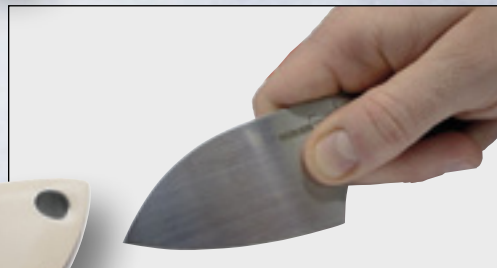

7
Boker Plus
Sanyougo
White.
\$ 55.95



8
Boker Plus
Sanyougo
Green.
\$ 55.95



7 BOKER PLUS SANYOUGO WHITE. Same impressive features and specifications as the original model (Item No. 03B0050), but with white Micarta handle scales and a satin finished blade made of 4116 steel. Blade length: 3 $\frac{3}{8}$ ". Overall length: 5 $\frac{5}{8}$ ". Weight: 2.5 oz.
Item No. 03B0052 \$ 55.95

8 BOKER PLUS SANYOUGO GREEN. Same impressive features and specifications as the original model (Item No. 03B0050), but with green canvas Micarta handle scales and a satin finished blade made of 4116 steel. Blade length: 3 $\frac{3}{8}$ ". Overall length: 5 $\frac{5}{8}$ ". Weight: 2.5 oz.
Item No. 03B0051 \$ 55.95



BOKER PLUS

The Anniversary of a Legend.



1
Boker
Plus KAL
Anniversary
Mini.
\$ 51.95

2
Boker
Plus KAL
Anniversary
Mini BK.
\$ 51.95

THE FAMOUS ASSAULT RIFLE
AUTOMAT KALASHNIKOV 47
TURNS 65! 1947-2012

BOKER PLUS KALASHNIKOV ANNIVERSARY SERIES. The technical pioneering spirit of General Kalashnikov and his masterpiece, the construction of the world famous and probably most common assault rifles shows itself in the 65th Anniversary of the legendary weapon. As the official manufacturer of Kalashnikov knives, we honor the success of General Kalashnikov, and dedicate this whole series of limited edition knives to this special occasion. Each model will feature the exclusive

anniversary blade etch and individual serial number, and will be limited to just 650 pieces worldwide! Available in eight models:

1 BOKER PLUS KAL ANNIVERSARY MINI. This liner locking model features an olive drab coated aluminum handle and satin finished AUS-8 stainless steel blade with special anniversary logo. Blade length: 2½". Overall length: 5¾". Weight: 2.1 oz.
Item No. 01KAL63 \$ 51.95

2 BOKER PLUS KAL ANNIVERSARY MINI BK. This liner locking model features an olive drab coated aluminum handle and black coated, partially serrated AUS-8 stainless steel blade with special anniversary logo. Blade length: 2½". Overall length: 5¾". Weight: 2.1 oz.
Item No. 01KAL63B \$ 51.95

3 BOKER PLUS KAL ANNIVERSARY. This heavy duty model features olive drab Zytel handle scales on massive steel liners, and a removable glass blade breaker tip. The 440C stainless steel blade is satin finished, and boasts the special anniversary logo. Sturdy liner lock mechanism. Blade length: 4". Overall length: 9⅞". Weight: 6.4 oz.
Item No. 01KAL650 \$ 133.95



3
Boker
Plus KAL
Anniversary.
\$ 133.95

4
Boker Plus KAL
Anniversary BK.
\$ 133.95



Mikhail Timofeevich Kalashnikov



5
Boker Plus KAL Anniversary.
\$ 61.95

NON-AUTOMATIC



6
Boker Plus KAL Anniversary BK.
\$ 61.95

7
Boker Plus KAL Anniversary.
\$ 61.95

4 BOKER PLUS KAL ANNIVERSARY BK. This heavy duty model features olive drab Zytel handle scales on massive steel liners, and a removable glass breaker tip. The 440C stainless steel blade is black coated and partially serrated, and boasts the special anniversary logo. Sturdy liner lock mechanism. Blade length: 4". Overall length: 9⁷/₈". Weight: 6.4 oz. Item No. 01KAL651 \$ 133.95

5 BOKER PLUS KAL ANNIVERSARY. This button lock model (non-automatic) features an olive drab coated aluminum handle and satin finished AUS-8 stainless steel blade with special anniversary logo. Blade length: 3³/₄". Overall length: 7¹/₂". Weight: 3.5 oz. Item No. 01KALS65 \$ 61.95

6 BOKER PLUS KAL ANNIVERSARY BK. This button lock model (non-automatic) features an olive drab coated aluminum handle and black coated, partially serrated AUS-8 stainless steel blade with special anniversary logo. Blade length: 3³/₄". Overall length: 7¹/₂". Weight: 3.5 oz. Item No. 01KALS65B \$ 61.95

7 BOKER PLUS KAL ANNIVERSARY. This liner locking model features an olive drab coated aluminum handle and satin finished AUS-8 stainless steel blade with special anniversary logo. Blade length: 3³/₄". Overall length: 7¹/₂". Weight: 3.5 oz. Item No. 01KAL65 \$ 61.95

8 BOKER PLUS KAL ANNIVERSARY BK. This liner locking model features an olive drab coated aluminum handle and black coated, partially serrated AUS-8 stainless steel blade with special anniversary logo. Blade length: 3³/₄". Overall length: 7¹/₂". Weight: 3.5 oz. Item No. 01KAL65B \$ 61.95



8
Boker Plus KAL Anniversary BK.
\$ 61.95



BOKER PLUS



1
Boker Plus
Kalashnikov
2009.
\$ 46.95



2
Boker Plus
KAL10S.
\$ 54.95



3
Boker Plus
KAL10T.
\$ 54.95

1 BOKER PLUS KALASHNIKOV 2009. A stunning project in our famous Kalashnikov Series: a solid aluminium handle with extraordinary ergonomics houses a massive blade which knows no limits. Every task which might come up will be handled with ease. The handle structure provides a very secure grip and makes the knife absolutely slip-proof under all conditions. 440 stainless steel blade. Includes Cordura sheath (does not have pocket clip). Blade length: 3¾". Overall length: 8⅝". Item No. 01KAL09 \$ 46.95

BOKER PLUS AUTOMAT KALASHNIKOV 10 SERIES. The new KAL10 folder, with its innovative interpretation of the typical Kalashnikov elements, sets a new standard in design and function. The slip-proof scales are made of aluminum, mounted on steel liners,

which bear the solid liner lock mechanism. The expressive handle design with the raised palm support and the pronounced index finger choil offer outstanding ergonomics and safety in use. The bullet-shaped opening hole offers ambidexterity for blade opening. High performance 440C stainless steel blade. Lanyard hole and belt pouch (included) complete the package. Blade length: 3½". Overall length: 8⅞". Weight: 6 oz. Available in two versions:

2 BOKER PLUS KAL 10S. The effective spear point blade sports a proven recurve grind with aggressive serrations, making it most effective when performing pulling cuts and various cutting tasks. Item No. 01KAL10S \$ 54.95

3 BOKER PLUS KAL 10T. The tanto version offers maximum stability, with a straight edge for precise cutting, as well as improved tip strength. Partially serrated. Item No. 01KAL10T \$ 54.95

4 BOKER PLUS KAL 11. This impressive tactical knife, the newest addition to our Kalashnikov family, is a massively built pocket knife with a powerful tanto style blade. The sturdy handle, with its textured aluminum shell, fits perfectly in the hand and provides a secure grip in any situation. The blade is black coated, high performance 440C stainless steel. Also features a seatbelt cutter for added functionality. Blade length: 3⅜". Overall length: 8⅞". Weight: 6.5 oz. Item No. 01KAL11 \$ 41.95

5 BOKER PLUS KAL 12S. The latest generation of Kalashnikov folding knives not only convinces with an outstanding grip of the aluminum scales, but also includes a belt cutter and solid, removable glass breaker tip. The steel plates are the base for the

secure liner locking mechanism, and the two lanyard holes ensure the securing of the knife against loss. The spear point blade with aggressive serrations is made of 440C stainless steel, and can be easily opened with the flipper or thumb stud. Does not have pocket clip. Includes a durable Cordura sheath. Blade length: 3⅞". Overall length: 7⅞". Weight: 5.4 oz. Item No. 01KAL12S \$ 51.95

6 BOKER PLUS KAL 12T. Same features and specifications as the spear point model above (item 01KAL12S), but with a tanto style blade. Does not have pocket clip. Includes a durable Cordura sheath. Blade length: 3⅞". Overall length: 7⅞". Weight: 5.4 oz. Item No. 01KAL12T \$ 51.95

7 BOKER PLUS KAL 10 FIXED BLADE. A rugged tactical fixed blade for a wide variety of tasks. The tanto blade, with a thickness of more than 5mm, makes this a truly solid knife. The aluminum handle scales provide excellent grip and secure handling. The double handguard offers great versatility and features an additional notched thumb ramp. An expressive design, which enthruses the user as well as the collector. The blade steel is high performance 440C stainless. Includes a Cordura sheath. Blade length: 5⅞". Overall length: 11¼". Weight: 12.5 oz. Item No. 02KAL10 \$ 82.95



4
Boker Plus
KAL 11.
\$ 41.95



5
Boker Plus
KAL12S
\$ 51.95



6
Boker Plus
KAL12T.
\$ 51.95



7
Boker Plus KAL10
Fixed Blade.
\$ 82.95



BOKER PLUS



Kalashnikov Plus.



1
Boker Plus
Kalashnikov 101.
\$ 118.95



2
Boker Plus
Kalashnikov 102.
\$ 118.95



3
Boker Plus
Kalashnikov 103.
\$ 118.95



Production
Prototype
Picture

can be opened with the thumb stud or the side-guards, even with gloves on. The glass breaker tip at the end of the handle is another useful feature of the 101. Liner locking system and pocket clip for tip-up carry. Blade length: 4". Weight: 6.4 oz. Available in three versions:

1 BOKER PLUS KALASHNIKOV 101. With bead blasted plain edge blade. Item No. 01KAL101 \$ 118.95

2 BOKER PLUS KALASHNIKOV 102. With black coated partially serrated blade. Item No. 01KAL102 \$ 118.95

3 BOKER PLUS KALASHNIKOV 103. As a heavy duty folder, the Kalashnikov 101 series has successfully proven itself! The extreme sturdiness, outstanding ergonomics, and multiple fields of application make these knives reliable working tools. Now we bring you another interesting model to complete the series. Same features and specifications as the other two models (above), but without the flipper. Also

BOKER PLUS AUTOMAT KALASHNIKOV 101 SERIES. Three recent models of the only officially licensed Kalashnikov knife series. With an overall length of 9 7/8", the new 101 design is a massive heavy duty knife, which performs extremely well not only in tactical situations, but also in the great outdoors. The FRN handle scales provide a safe and secure grip, and the 1.5mm stainless steel liners underneath the handle scales provide extreme stability. Friction grooves in the handle and thumb ramp allow safe handling. The rust resistant 440C stainless steel blade

4
Boker Plus
Tactical.
\$ 56.95

5
Boker Plus
Tactical.
\$ 56.95

features a desert Zytel handle and stonewash finish on the 440C stainless steel blade. Removable thumb disc and glass breaker tip. Includes pocket clip. Blade length: 4". Overall length: 9 7/8". Weight: 6.4 oz. Item No. 01KAL103 \$ 118.95

BOKER PLUS KAL 74 SERIES. This innovative interpretation of the Kalashnikov series is designed for our line of Boker Plus knives. The blade is made of AUS-8 stainless steel. Structured finger grooves on the aluminium handle provide a secure grip. Non-automatic. Available in six versions:

4 BOKER PLUS TACTICAL. Push button lock (non-automatic) with black handle and bead blast, plain edge, 3 1/4" blade. Overall length: 7 1/2". Weight: 3.5 oz. Includes pocket clip. Item No. 01KALS74 \$ 56.95

5 BOKER PLUS TACTICAL. Liner lock with black handle and bead blast, plain edge, 3 1/2" blade. Overall length: 8". Includes pocket clip. Weight: 4.9 oz. Item No. 01KAL74 \$ 56.95

6 BOKER PLUS DESERT. Push button lock (non-automatic) with sand-colored handle and blade. Blade length: 3 1/4". Overall length: 7 1/2". Weight: 3.5 oz. Includes pocket clip. Item No. 01KALS74DES \$ 56.95

7 BOKER PLUS OD. Push button lock (non-automatic) with olive drab handle and partially serrated, black coated, 3 1/4" blade. Overall length: 7 1/2". Weight: 3.5 oz. Includes pocket clip. Item No. 01KALS74B \$ 56.95

8 BOKER PLUS OD. Liner lock with olive drab handle and partially serrated, black coated, 3 1/2" blade. Overall length: 8". Weight: 4.9 oz. Includes pocket clip. Item No. 01KAL74B \$ 56.95

6
Boker Plus
Desert.
\$ 56.95

7
Boker Plus OD
\$ 56.95

8
Boker Plus OD.
\$ 56.95

NON-AUTOMATIC



BOKER PLUS



1
Boker Plus
KAL Mini
Black.
\$ 51.95



2
Boker Plus
KAL Mini.
\$ 51.95



3
Boker Plus
KAL Tanto
Mini Plain.
\$ 51.95



NON-AUTOMATIC

4
Boker Plus KAL
Tanto Mini.
\$ 51.95



5
Boker Plus
KAL Mini.
\$ 51.95



6
Boker Plus KAL
Mini Black.
\$ 51.95



BOKER PLUS MINI KALASHNIKOV.
The answer to the call for a more compact version of our popular Kalashnikov 74 Series (shown on page 81). These knives feature the same sturdy construction, with blades made of AUS-8 stainless steel, and rugged aluminum handles with structured finger grooves for a secure grip. Includes pocket clip. Blade length: 2½". Overall length: 5¾". Weight: 2.1 oz. Available in six versions:

1 BOKER PLUS KAL MINI BLACK. With black coated, partially serrated blade and button lock mechanism (non-automatic). Item No. 01KALS73B \$ 51.95

2 BOKER PLUS KAL MINI. With plain edge blade and button lock mechanism (non-automatic). Item No. 01KALS73 \$ 51.95

3 BOKER PLUS KAL TANTO MINI PLAIN. With black coated, tanto style, plain edge blade and button lock mechanism (non-automatic). Item No. 01KALS73BT \$ 51.95

4 BOKER PLUS KAL TANTO MINI. With black coated, tanto style, partially serrated blade and button lock mechanism (non-automatic). Item No. 01KALS73BTS \$ 51.95

5 BOKER PLUS KAL MINI. With plain edge blade and liner lock mechanism. Item No. 01KAL73 \$ 51.95

6 BOKER PLUS KAL MINI BLACK. With black coated, partially serrated blade and liner lock mechanism. Item No. 01KAL73B \$ 51.95

7 BOKER PLUS RBB FIXED EDC. The overwhelming success of our RBB Series from Jim Wagner continues. Even the larger, full sized version is very popular, but there have been many requests for a more EDC-friendly version, which we present to you here. This new RBB fixed blade features a recurved blade made of 440C stainless steel for powerful and effective cutting, while the screwed on aluminum handle provides a secure grip. The handling is supported by a thumb ramp and a deep index finger choil. The tang has holes, underneath the handles, for reduced weight without weakening the construction. The interchangeable glass breaker tip offers added functionality. Includes a Kydex sheath and belt adapter. Blade length: 3½". Overall length: 8½". Weight: 7.1 oz. Item No. 02B0050 \$ 119.95

NEW

7
Boker Plus
RBB Fixed
EDC.
\$ 119.95



8
Boker Plus
CFR.
\$ 128.95

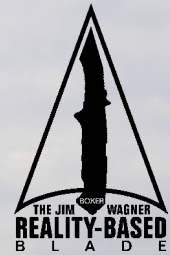

9
Boker Plus
RBB Outdoor.
\$ 127.95



8 BOKER PLUS CFR. The Combat First Responder: Designation for troop members serving as paramedics and emergency personnel aside from combat. The new Boker Plus CFR can also master any task, providing an uncompromising rescue knife. In an

emergency, it can be used near the body without risk, and also acts as a standard knife due to the full fledged cutting edge and blade tip. The belt cutter can be easily used when the blade is closed as well. Also features a removable glass breaker tip and thumb

disc. The black coated blade is made of high performance 440C stainless steel. Blade length: 3 7/8". Overall length: 9". Weight: 6.2 oz.
Item No. 01B0045 \$ 128.95

9 BOKER PLUS RBB OUTDOOR. This new version of the tried and true Reality Based Blade (see page 84) features a versatile blade shape, ideal for outdoor and everyday use. The matte blasted

blade is made of high performance 440C stainless steel, and locks with a sturdy lockback mechanism. Blade length: 3 7/8". Overall length: 9". Weight: 6.2 oz.
Item No. 01B0046 \$ 127.95



BOKER PLUS

When seconds count, be prepared.

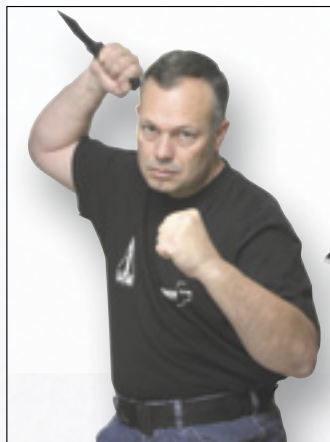

Jim Wagner

1
Boker Plus
Reality Based
Recurve.
\$ 108.95



2
Boker Plus
RBB Serrated.
\$ 108.95



3
Boker Plus
RBB Plain.
\$ 108.95

BOKER PLUS REALITY-BASED BLADE. The knives on these pages are designed for both ends of the lifesaving spectrum... defense and rescue. After knife fighting expert Jim Wagner trained German top counterterrorism team, GSG9, in knife tactics, Boker requested that he design the ultimate tactical folding knife for police, military and security personnel. The end result was the Reality Based Blade.

The Jim Wagner reality-based blade design has tactical features that few others have. A gladius tip, a cutting kris curve, unique blood grooves, ergonomic finger grooves with anti-slip texturing, and a thumb guide slide. Also includes a clip kit that can transfer a glass-breaker into a writing pen clip for undercover operations. Two lanyard holes are available for air, water or wilderness operations. With the blade in the

retracted position, a secure high impact weapon is in the ready position. Solid stainless steel liners in addition to the FRN handles and solid lock back system provide all the security required when needed most.

1 BOKER PLUS REALITY BASED RECURVE. The design of the recurved blade makes everyday cutting chores a breeze. Both sides of the 440C stainless steel blade are flat ground, for easy re-sharpening. The blade is black-coated, which provides added corrosion resistance. Overall length: 9". Blade length: 3⁷/₈". Weight: 6.2 oz. Item No. 01B0053 \$ 108.95

2 BOKER PLUS RBB SERRATED. With partially serrated blade. Item No. 01B0051 \$ 108.95

3 BOKER PLUS RBB PLAIN. Plain edge blade. Item No. 01B0050 \$ 108.95

These Jim Wagner models were developed based on the demand for a Reality-Based Blade in a smaller, lighter version. The black coated aluminum handles are based on our famous KAL 74 series. The impressive result is a lightweight but sturdy knife that proves to be reliable and highly functional. The black coated stainless steel blades are locked in the open position with a push button lock. Also includes reversible pocket clip, interchangeable glass breaker tip and false writing pen tip. Non-automatic.

4 BOKER PLUS RBB DROP. The perfect combination of a very useful every day carry knife and an efficient self defense knife. With a black coated AUS-8

steel blade in the popular drop point style and the very secure push button lock, this knife is ready for anything. Overall length: 7¹/₂". Blade length: 3¹/₄". Weight: 3.6 oz. Item No. 01B0048 \$ 103.95

5 BOKER PLUS RBB TANTO. The legendary Jim Wagner RBB in a more handy version with a black coated, partially serrated AUS-8 stainless steel blade. Blade length: 3¹/₄". Overall length: 7¹/₂". Weight: 3.5 oz. Item No. 01B0054 \$ 103.95

6 BOKER PLUS RBB RECURVE. The Reality-Based Recurve, ideal for everyday carry. With a black coated, plain edge AUS-8 stainless steel blade. Blade length: 3¹/₄". Overall length: 7¹/₂". Weight: 3.5 oz. Item No. 01B0055 \$ 103.95





Kris shaped blade with unique blood grooves.



Glass breaker tip.



False writing pen clip.

4
Boker Plus
RBB Drop.
\$ 103.95

5
Boker Plus
RBB Tanto.
\$ 103.95

6
Boker Plus
RBB Recurve.
\$ 103.95

NON-AUTOMATIC

7 BOKER PLUS URBAN SURVIVAL. The latest from knife fighting expert Jim Wagner! With an overall length of 5²/₃" and a blade length of 1³/₈", the Urban Survival offers the ultimate in carrying comfort with its compact dimensions. The sleek construction and scalpel-like blade offer optimum control. Includes pocket clip, blade lifter, and interchangeable glass breaker and false writing pen tip. Weight: 1.5 oz. Item No. 01B0047 \$ 47.95

False writing pen clip.



7
Boker Plus
Urban
Survival.
\$ 47.95

8 BOKER PLUS RBB FIXED. The first fixed blade in the successful RBB Series. A highly innovative concept without any compromise. The 440C stainless steel blade has an overwhelming strength of 6mm, in the typical RBB tanto style. The guard at the end of the handle offers protection in any cutting task (or while using the glass-breaker), and also can be used as a lever. Includes a sturdy nylon fiber sheath for convenient carry. Tek-Lok included. Overall length: 9³/₄". Blade length: 5¹/₄". Weight: 8.9 oz. Item No. 02B0049 \$ 175.95

8
Boker Plus
RBB Fixed.
\$ 175.95



BOKER PLUS



Innovation Plus.



All knives feature a reversible tip up/tip down clip.

1
Boker Plus
Folder I.
\$ 46.95

2
Boker Plus
Folder II.
\$ 57.95

3
Boker Plus
Folder I.
\$ 46.95



BOKER PLUS ARMED FORCES SERIES. Everyone knows the so-called PX Shops that you can find on U.S. military bases all over the world. U.S. soldiers can buy additional equipment, like knives, privately. Aside from the regular manufactured brand knives, the ARMED FORCES develops some special models that fit the needs and requirements of the fighting soldiers. The order for different fighting knives was given for the first time to a foreign company, Boker, under the label BOKER PLUS. The main characteristic is that all models would be designed to perform under any circumstances with the best price-performance ratio. PVD-coated 440C stainless steel blades provide the best edge-holding ability, ideal for rugged field use. The handles are made of solid G-10, which will hold up even

under rigorous field use. A deep checkering prevents slipping of the handles. The first choice of the U.S. ARMED FORCES on their worldwide mission.

BOKER PLUS ARMED FORCES TANTO FOLDERS. These folding knives are nearly as tough as the fixed blade versions. The hollow-ground, partially serrated blade is secured in the opened position with the liner lock. Includes pocket clip. Available in two sizes:

1 BOKER PLUS FOLDER I. Overall length: 6¾". Blade length: 2⅝". Weight: 3.4 oz. Item No. 01B0112 \$ 46.95

2 BOKER PLUS FOLDER II. Overall length: 9⅓". Blade length: 3¾". Weight: 6.8 oz. Item No. 01B0114 \$ 57.95

3 BOKER PLUS ARMED FORCES SPEARPOINT FOLDER. After multiple requests from international units, the popular Armed Forces Folder is also available with a handy spearpoint blade. This blade shape broadens the variety of uses and applications and offers superior functionality for everyday tasks as well as the finer, more precise cutting chores. The partially serrated black PVD-coated blade is made of 440C stainless steel, which offers outstanding edge retention and corrosion resistance. Overall length: 6⅞". Blade length: 2¾". Weight: 3.4 oz. Item No. 01B0113 \$ 46.95

4 BOKER PLUS RESCOM RED. The introduction of the Subcom Folder caught the interest of the military, who were amazed at the cutting power made available in such a compact design. With the number of rollovers and extractions involving the military Humvees multiplying, a request was

delivered to design a formidable seatbelt cutter that could be included into their rescue kits. The resulting Rescom not only zips through heavy duty seatbelts, but also through heavy boxes, strapping material, nylon cord and rope. Cutter is made of AUS-8 steel, and the front handle scale is fiberglass-reinforced nylon in flashy red, ideal for emergency personnel. Includes pocket clip. Blade length: 1⅞". Overall length: 4½". Weight: 2.4 oz. Item No. 01B0584 \$ 51.95

5 BOKER PLUS RESCOM BLACK. Same features and specifications as model 01B0584 (above), but with a black handle and black coated blade for outstanding corrosion resistance in water missions (such as rafting). Includes pocket clip. Blade length: 1⅞". Overall length: 4½". Weight: 2.4 oz. Item No. 01B0583 \$ 51.95

4
Boker Plus
Rescom Red.
\$ 51.95



5
Boker Plus
Rescom Black.
\$ 51.95



6 BOKER PLUS CAMO DEFENDER. This Boker Plus model is designed to handle any task. Rugged, functional - ideal as an EDC. The aluminum handle with reptile grip inlays provides an extremely secure grip under any and all circumstances. The double guards allow super-fast deployment of the blade, even with gloves on, and provide added protection for the fingers during heavy duty cutting tasks. The partially serrated edge can easily cut through rope, webbing, belts, etc., and the reversible clip allows for four-way carry. Overall length: 7³/₄". Blade length: 3³/₈". Weight: 6.1 oz. Item No. 01B0119 \$ 31.95

6
Boker Plus
Camo Defender.
\$ 31.95



7 BOKER PLUS TD. This tactical piece from Boker Plus can handle anything. Features a lightweight Zytel handle with a lanyard hole and reversible pocket clip. The plain edge blade is made of ultra sturdy AUS-8 steel, black-coated. Safety backlock system. Blade length: 3". Overall length: 7¹/₈". Weight: 3 oz. Item No. 01B0190 \$ 46.95

7
Boker Plus TD.
\$ 46.95



8 BOKER PLUS TD YELLOW. Same specifications as the original TD model (above), but with a partially serrated, uncoated blade and vibrant yellow handle. Item No. 01B0191Y \$ 46.95

8
Boker Plus TD
Yellow.
\$ 46.95



9 BOKER PLUS CREDIT CARD KNIFE. A unique design from Massachusetts knifemaker John Kubasek. With its compact dimensions, slim profile, and removable pocket clip, this piece offers a variety of carry options. Fits perfectly in the credit card compartment of your wallet, can be carried via clip in the pocket of your shirt, or on a ball chain (included) around your neck. This extremely lightweight knife also features a reliable and sturdy frame lock mechanism, titanium liner and high performance 440C stainless steel blade. The finger choils and handle end provide a surprisingly ergonomic and comfortable grip. The perfect everyday companion! Closed length: 2³/₄". Blade length: 2¹/₄". Overall length: 5". Weight: 1.1 oz. Item No. 01B0010 \$ 35.95

9
Boker Plus
Credit Card
Knife.
\$ 35.95



Extremely flat build for comfortable carry, and removable clip for wallet carry.

JOHN KUBASEK
MAKER
EASTHAMPTON, MA



BOKER PLUS

1A
Boker Plus
Kydex Sheath.
\$ 31.95



In collaboration with:



1
Boker Plus
Cop Tool.
\$ 82.95



Glass-breaker tip

2
Boker Plus
MA-2.
\$ 35.95



3
Boker Plus
MA-4.
\$ 97.95



1 BOKER PLUS COP TOOL. Finally, a deployment tool that easily covers the entire range of tasks in duty, service, hobby and leisure. Developed and field tested by Roy Huntington, a police officer with more than twenty years of experience. Now Wilson Tactical and Boker begin an exclusive collaboration to make this perfect tool available for a reasonable price point. The Cop Tool can be used as a lever, chisel, belt cutter, scraping tool, glass-breaker, or as a multifunctional knife. Small, compact, and extremely effective. The bead blasted blade is made of high performance 440C stainless steel. For the perfect grip, even with gloves or wet hands, Boker uses a textured G-10 for the handle, which eliminates any danger

of slipping. The leather sheath can be carried discreetly in the waistband, or fits well on any gear belt next to other mission tools. The Boker Plus Cop Tool comes complete with lanyard as shown, and makes the perfect everyday companion. Overall length: 6". Blade length: 1¾". Weight: 4.2 oz. Item No. 02BO300 \$ 82.95

1A BOKER PLUS KYDEX SHEATH. For those who prefer a Kydex sheath for the Cop Tool, model 02BO300 (above). Designed to fit the Tek-Lok (model 09BO505, not included). Item No. 090301 \$ 31.95

2 BOKER PLUS MA-2. This innovative piece by American designers Miltner Adams offers extraordinary user safety. With its Top Grip™ construction, this knife is 100% safe in your hand, in any situation. The handle design allows the user to open his hand in order to grab or hold another object, without the risk of losing the knife. An extremely compact piece, ideal for a variety of tasks. The blade is made of 440C stainless steel, titanium coated. Includes a fiber-reinforced nylon sheath with belt clip. Blade length: 2⅞". Overall length: 5⅛". Weight: 1.6 oz. Item No. 02BO260 \$ 35.95

3 BOKER PLUS MA-4. Another impressive design by Miltner Adams. With the MA-4, we present the big

brother of the very popular MA-2 (above). The angled blade with the curved edge exhibits its full potential, especially in pulling cuts, while the contoured handle and deep finger choils provide a maximum of grip and safety. Quick cuts in an emergency situation are accomplished easily with the MA-4. An extraordinary knife, which provides great function, in any situation. Dark gray aluminum handle scales with an AUS-8 steel blade. Includes an innovative Zytel sheath system and a large Tek-Lok. Blade length: 3¾". Overall length: 6¾". Weight: 4.7 oz. Item No. 02BO261 \$ 97.95

4 BOKER PLUS KRESSLER SUBHILT FIGHTER. Dietmar Kressler, one of Germany's most famous knifemakers, is our partner in one of the most demanding and challenging projects we have ever introduced into our Boker Plus Series. The result was worth the long period of hard work - we are very proud to present the Boker Plus Kressler

Subhilt Integral Fighter. The handguard, as well as the second hilt and handle butt are all an integral part of the knife, which is drop forged to the final shape. One solid piece of steel, without any separate parts like bolsters or guards. As an additional feature, we added a tapered tang. This complex and elaborate production procedure results in an extremely solid piece with a unique and noble appearance. As blade steel, we chose 440C stainless, which is well proven with its outstanding edge retention and corrosion resistance. Black canvas Micarta, fastened with stainless steel tubes, provides an excellent grip and an attractive contrast to the mirror polished surface. The second hilt provides an uncomparable safe and secure handling in any situation. The Kressler Subhilt Fighter is a real "Gesamtkunstwerk," which is absolutely unique within the world of production knives. We are happy to offer such a fascinating collector's piece to the knife aficionado, displaying the high standards that we demand in all of our products, to set the bar high with such exceptional items. Comes in a collector's case and includes a high quality leather sheath. Blade length: 7½". Overall length: 12⅞". Weight: 15.5 oz. Item No. 02BO190 \$ 359.00

5 BOKER PLUS SUBHILT FIGHTER II. Due to the overwhelming success of our original Subhilt Fighter by Dietmar Kressler (above), we bring you a handier version in a smaller size, while maintaining the sophisticated features of the original. A true collector's item that can also handle multiple cutting tasks with ease, offering an outstanding price-performance ratio. Each knife is serial numbered, and comes complete with an exclusive leather sheath and certificate of authenticity, packaged in an attractive collector's box. Blade length: 4¾". Overall length: 9½". Weight: 11.4 oz. Item No. 02BO191 \$ 310.95

4
Boker Plus
Kressler
Subhilt
Fighter.
\$ 359.00

5
Boker Plus
Subhilt
Fighter II.
\$ 310.95



KRESSLER

BOKER PLUS

A warrior's workhorse.

1
Boker Plus
Airforce
Pilot
Survival
Knife.
\$ 77.95



2
Boker Plus
Mark 1
Navy Knife.
\$ 87.95



3
Boker Plus
V-42 Devil's
Brigade.
\$ 108.95



A WARRIOR'S WORKHORSE.

There are times when you require a rugged knife to get you out of some perilous situations. The fixed blade knives shown here have done just that, from WWII to Iraq. Tough and dependable.

1 BOKER PLUS AIRFORCE PILOT SURVIVAL KNIFE. A reissue of an extremely rare standard issue knife. In the late 1940's, General Curtis LeMay, the head of the Strategic Air Command (SAC), authorized the creation of a survival kit for the crews of the long range bombers. Requirements were to be an effective tool for survival in the wild, with the ability to perform a number of functions to include field dressing and cleaning fish. A must was that the knife had to be lightweight. The Air Force reviewed the Randall Model 14, but deemed it too heavy. Decision makers who were well aware of the "Tree Brand" product requested input from Boker. The initial production of 300 pieces for evaluation resulted in immediate approval and the Boker fixed blade became the official survival knife of the U.S. Air Force. The 8^{3/8}" overall knife has a 4^{1/2}" SK-5 carbon steel blade, mirror finished. The handle is crafted of leather, with aluminum and brass spacers and pommel. Includes an SAC leather sheath. Weight: 3.6 oz. Item No. 02B0155 \$ 77.95

2 BOKER PLUS MARK 1 NAVY KNIFE. Our Boker Plus line of historical knives from the U.S. Armed Forces is now followed by this impressive piece. The Mark 1 Navy knife was used by the U.S. Navy, and the main difference between this model and other knives from that era is the large synthetic pommel at the end of the classic leather handle. During WWII, this knife was manufactured by H. Boker & Co. in the USA (one of several manufacturers) for the U.S. Navy. This model features an SK-5 high carbon steel blade, and includes an authentic leather sheath. A unique piece with a special history, which is not only ideal for the collector, but also makes an excellent outdoor knife. Serialized. Blade length: 5^{1/2}". Overall length: 10^{1/4}". Weight: 6 oz. Item No. 02B0156 \$ 87.95



3 BOKER PLUS V-42 DEVIL'S BRIGADE.

Devil's Brigade originated in July of 1942. Under the official title, 1st Special Service Force, American and Canadian soldiers were combined together to form a special task force trained for battle behind enemy lines. The origin of many special units can be traced back to this special force. Due to numerous nocturnal operations where all faces were blackened for camouflage, the German Wehrmacht invented their nickname, "Black Devils," which bore witness of the great respect they had of their enemy, although their unit was relatively small. In 1943 and 1944, the 1st SSF successfully completed many operations in Italy and France, impacting military operations. An important piece of equipment of the Devil's Brigade was the specially designed V-42 combat knife, which was also part of the intensive close combat training. The handle of compressed leather discs ends in a pointed impact cap. A thick leather padding underneath the slightly curved handguard offered protection from injury. The double-edged blade of the dagger features a corrugated thumb rest for a secure grip. To this day, the crest of the Special Forces of the U.S. Army adorns this legendary dagger. We not only deliver this exclusive collector's item with its classic leather sheath, but also with a replica of the cloth insignia of the unit, which is the red spearhead, and with a reproduction of the original German sticker with the words "The worst is yet to come!", which was stuck behind enemy lines in order to demoralize the enemy. A premium collector's ensemble, especially ideal for aficionados of military history! Blade length: 7". Overall length: 12". Weight: 7 oz. Item No. 02B01942 \$ 108.95

4 BOKER PLUS M3 TRENCH KNIFE.

Designed in 1943, the M3 Trench Knife was intended to be used by any U.S. soldier during World War II who was not equipped with a bayonet – soldiers with pistols, submachine guns, light and heavy machine guns, etc. The first troops to receive the M3's were the Airborne, Mountain Ranger and Glider infantry units. Among the nine manufacturers who produced the M3 during wartime was H. Boker & Co., with a total of 31,300 pieces, which was the smallest quantity. For the 65th anniversary, Boker Plus is reintroducing this classic piece of combat cutlery, along with a U.S. M8A1 scabbard. The black coated blade is made of high carbon SK-5 steel and features the original H. Boker & Co. blade tang. The handle is made of stacked leather pieces. To ensure the quality of the M3, each knife features a laser engraved serial number. Blade length: 6¾". Overall length: 11¾". Weight: 8.4 oz. Item No. 02B01943 \$ 108.95

4
Boker Plus M3
Trench Knife.
\$ 108.95

5
Boker Plus
Armed Forces
Fixed Blade.
\$ 92.95



BOKER PLUS

5 BOKER PLUS ARMED FORCES FIXED BLADE.

The first time you grab the handle of this knife, you will know that it will withstand harsh field use. The 7 1/3" tanto blade has a chisel grind and is partially serrated. Sturdy Cordura sheath included. Overall length: 13". Weight: 12.4 oz. Item No. 02B0216 \$ 92.95



Chad's Corner.



Chad Los Banos.
Member of the international Boker Design Team.



3
Boker Plus CLB Trance.
\$ 51.95



4
Boker Plus CLB Trance BK.
\$ 54.95



6
Boker Plus CLB M-Type.
\$ 75.95



7
Boker Plus CLB Hyper.
\$ 61.95



With the success of the Subcom Folder, our designer from Hawaii, Chad Los Banos, earned a lot of respect from the international cutlery community. His innovative designs and emphasis on functionality has resulted in a series of knives under the Boker Plus line.

1 BOKER PLUS CLB KEYCOM. The term "EDC" (Every Day Carry) gets a whole new dimension. With a compact size of just over 2 1/4" (closed), the Keycom can be conveniently carried on the key ring, and offers the ergonomics and functionality we already know from all of Chad Los Banos' designs. Frame lock, fiberglass reinforced nylon scale, pocket clip for tip-down carry. Blade is bead blasted AUS-8 steel. Includes key ring. Blade length: 1 1/2". Overall length: 3 3/4". Weight: 1.4 oz. Item No. 01B0530 \$ 28.95

2 BOKER PLUS CLB KEYCOM BLACK. Same specs as model 01B0530 (above), but with a black coated handle and blade. Item No. 01B0531 \$ 31.95

3 BOKER PLUS CLB TRANCE. This Chad Los Banos design fashionably combines a functionally powerful AUS-8 blade with an ergonomically shaped handle featuring a fiber reinforced nylon scale. The blade locks open with the framelock mechanism. The stainless steel pocket clip keeps it close at hand. Blade length: 2 3/4". Overall length: 6 1/4". Weight: 3.2 oz. Item No. 01B0590 \$ 51.95

4 BOKER PLUS CLB TRANCE BK. Same specifications as 01B0590 (above) but with a tactical black coated, partially serrated blade. Blade length: 2 3/4". Overall length: 6 1/4". Weight: 3.2 oz. Item No. 01B0596 \$ 54.95

5 BOKER PLUS TRANCE 42. This new Trance model shares all the impressive features of the original (model 01B0590), but with a slip joint mechanism. Blade length: 2 3/4". Overall length: 6 1/4". Weight: 3.2 oz. Item No. 01B0591 \$ 54.95

6 BOKER PLUS CLB M-TYPE. Chad's approach to the full size class of knives. Despite its blade length of 3 5/8", the knife will not be bulky in your pocket, and therefore offers exceptional carrying comfort. The slightly recurved blade guarantees phenomenal cutting performance, and the discreet titanium coating on the handle and blade creates

an elegant and tactical look. Includes convertible pocket clip. 440C stainless steel blade. Overall length: 8 1/8". Weight: 4.6 oz. Item No. 01B0560 \$ 75.95

7 BOKER PLUS CLB HYPER. The sturdy framelock guarantees a securely locked blade and the stainless steel handle featuring G-10 and Grip-Zones offers plenty of gripping safety in any carry position, even despite its compact dimensions. The handle, clip and 440C stainless steel blade are all covered with a titanium coating. Clip allows for tip-up or tip-down carry. Blade length: 2 3/4". Overall length: 6 5/8". Weight: 3.6 oz. Item No. 01B0550 \$ 61.95

SLIP JOINT DESIGN

8 BOKER PLUS CLB SUBCOM FOLDER. The original "Biscuit". The Subcom Folder has a municipal-friendly blade, at 1 7/8" long and 1/16" thick. The blade is beadblasted AUS-8 stainless steel and boasts an ambidextrous thumb stud. The reversible pocket clip and compact size of this frame lock model make for an ideal money clip. Both thumb and palm index ramps provide for a secure grip. The handle scale is fiberglass reinforced nylon. Lightweight, only 2.5 oz. Overall length: 4 1/2".
Item No. 01B0589 \$ 48.95

9 BOKER PLUS CLB SUBCOM BLACK. Same specifications as model 01B0589 (above), but with a black partially serrated blade and handle.
Item No. 01B0586 \$ 48.95

10 BOKER PLUS CLB SUBCOM TITAN. The Subcom Folder from Chad Los Banos was one of the keystones of the Boker Plus lineup, and quickly became one of the most popular designs from Boker. As a show of appreciation to Chad and all the loyal fans of this exceptional knife concept, we are offering a very special version, and are proud to present the Subcom Folder as a Titanium Framelock. To maintain the original dimensions, the handle scales are CNC milled with maximum precision. The original handle pattern is also milled in the scale to show the bridging, just like the original. The two-tone titanium scales feature bead blasted and fine satin finished parts, creating, in combination with the titanium clip, a very distinctive appearance. Blade steel is high performance 440C stainless. A real Boker Plus classic in a modern, high tech package. Blade length: 1 7/8". Overall length: 4 1/2". Weight: 2.3 oz.
Item No. 01B0582 \$ 61.95

11 BOKER PLUS SUBCOM 42 TITAN. Another exciting addition to our very successful Subcom Series, we bring you the popular Titan model featuring a slip joint, rather than a frame lock mechanism. The two-tone titanium scales feature bead blasted and fine satin finished parts, creating, in combination with the titanium pocket clip, a very distinctive appearance. The blade steel is high performance 440C stainless. Blade length: 1 7/8". Overall length: 4 1/2". Weight: 2.5 oz.
Item No. 01B0592 \$ 71.95

12 BOKER PLUS SUBCOM 42 PINK. The Subcom goes pink! The newest addition to our very popular Subcom Series. The AUS-8 stainless steel blade features an ambidextrous thumb stud, and the reversible pocket clip and compact size make for an ideal money clip. Both thumb and palm index ramps provide for a secure grip. The pink handle scale is fiberglass reinforced nylon. This new Subcom model is the first to feature a slip joint, rather than a frame lock mechanism. Blade length: 1 7/8". Overall length: 4 1/2". Weight: 2.5 oz.
Item No. 01B0593 \$ 48.95



8
Boker Plus
CLB Subcom
Folder.
\$ 48.95



9
Boker Plus CLB
Subcom Black.
\$ 48.95



10
Boker Plus CLB
Subcom Titan.
\$ 61.95



11
Boker Plus
Subcom Titan 42.
\$ 71.95



12
Boker Plus
Subcom 42
Pink.
\$ 48.95



13 BOKER PLUS CLB SUBCOM CAMO. Same features and specifications as Subcom Black (model 01B0586), but featuring a gray handle scale and black serrated blade and handle. Framelock.
Item No. 01B0589CAMO \$ 48.95

13
Boker Plus CLB
Subcom Camo.
\$ 48.95

SLIP JOINT DESIGN



BOKER PLUS

NEW



1
Boker Plus
Subcom Dusk.
\$ 48.95

NEW



2
Boker Plus
Subcom Dawn.
\$ 48.95

NEW



3
Boker Plus
Subcom Dawn 42.
\$ 48.95

NEW



4
Boker Plus
Optima Black.
\$ 62.95



5
Boker Plus
Optima Orange.
\$ 62.95

NEW



1 BOKER PLUS SUBCOM DUSK. The Subcom gets a new look! The newest addition to our very popular Subcom Series. The black coated AUS-8 stainless steel blade features an ambidextrous thumb stud, and the reversible pocket clip and compact size make for an ideal money clip. Both thumb and palm index ramps provide for a secure grip. The orange handle scale is fiberglass reinforced nylon. Frame lock mechanism. Blade length: 1 7/8". Overall length: 4 1/2". Weight: 2.5 oz.
Item No. 01B0576 \$ 48.95

2 BOKER PLUS SUBCOM DAWN. Another exciting new model in our popular Subcom Series! Featuring a plain edge AUS-8 stainless steel blade with an ambidextrous thumb stud. The reversible pocket clip and compact size make for an ideal money clip. Both thumb and palm index ramps provide for a secure grip. The orange handle scale is fiberglass reinforced nylon. Frame lock mechanism. Blade length: 1 7/8". Overall length: 4 1/2". Weight: 2.5 oz.
Item No. 01B0579 \$ 48.95

3 BOKER PLUS SUBCOM DAWN 42. Same specifications as model 01B0579 (above), but in a slip joint version. Blade length: 1 7/8". Overall length: 4 1/2". Weight: 2.5 oz.
Item No. 01B0577 \$ 48.95

4 BOKER PLUS OPTIMA BLACK. For several years, we have offered the successful Boker Optima series - a real do-it-all knife, offering interchangeable blades. Its versatility convinced thousands of hunters worldwide. The demand for a lower budget model inspired us to create this modern variation, featuring a handle made of G-10, and blades made of AUS-8 stainless steel. This new model comes

NEW

6
Boker Plus
Ebony
Damascus.
\$ 124.95



NEW

7
Boker Plus Stag
Damascus.
\$ 129.95



NEW

8
Boker Plus
Damascus
Gent I.
\$ 99.95



NEW

9
Boker Plus
Damascus
Gent II.
\$ 89.95



complete with an interchangeable saw blade and belt sheath (the extra blade and belt sheath are not compatible with the Boker Optima series). Everything you need for your next hunting trip! Blade length: 3½". Overall length: 8¾". Weight: 6 oz. Item No. 01BO103 \$ 62.95

5 BOKER PLUS OPTIMA ORANGE. Same features and specifications as model 01BO103 (above), but with an orange G-10 handle for superior visibility in the field. Blade length: 3½". Overall length: 8¾". Weight: 6 oz. Item No. 01BO104 \$ 62.95

6 BOKER PLUS EBONY DAMASCUS. This noble gentleman's knife not only impresses with its contrasting 71-layer Damascus blade and generously dimensioned Damascus bolster, even the back spring is made of Damascus, with a fine file work which flows seamlessly into the back of the handle. The tang is slightly larger than the handles, which

provides comfortable use. The hand selected ebony scales are mounted on polished liners for added elegance. A truly unique and breathtaking piece! Blade length: 3". Overall length: 7⅞". Weight: 4.4 oz. Item No. 01BO166DAM \$ 124.95

7 BOKER PLUS STAG DAMASCUS. This piece impresses with its intricate, 71-layer Damascus steel blade and Damascus bolsters boasting a fine grain. The perfectly fitted scales, made of genuine stag, add a rugged touch. The extremely smooth action of the blade and precise locking mechanism

prove the high quality standard of the Boker Plus Series. Blade length: 3⅞". Overall length: 7". Weight: 4.1 oz. Item No. 01BO028DAM \$ 129.95

8 BOKER PLUS DAMASCUS GENT I. The extremely lightweight and flat construction of this noble gentleman's knife allows extraordinary carry comfort. The dark ebony wood and the intricate grain of the 67-layer Damascus create a discreet elegance. Liner locking mechanism and detachable pocket clip. Blade length: 3¼". Overall length: 7¾". Weight: 2.1 oz. Item No. 01BO101DAM \$ 99.95

9 BOKER PLUS DAMASCUS GENT II. A smaller version of the Gent I model (above). The extremely lightweight and flat construction of this noble gentleman's knife allows extraordinary carry comfort, along with its compact dimensions. The dark ebony wood and the intricate grain of the 67-layer Damascus create a discreet elegance. Liner locking mechanism and detachable pocket clip. Blade length: 2¾". Overall length: 6½". Weight: 1.6 oz. Item No. 01BO102DAM \$ 89.95



BOKER PLUS

1
Boker Plus
Exskelibur I.
\$ 92.95



2
Boker Plus
Exskelibur II.
\$ 67.95



3
Boker Plus
Exskelibur I
Maple Burl.
\$ 148.95



4
Boker Plus
Exskelibur II
Maple Burl.
\$ 122.95



5
Boker Plus
Exskelimoor II.
\$ 92.95



6
Boker Plus
Exskelimoor I.
\$ 108.95



SKELLERN

7
Boker Plus
Lockback Ebony.
\$ 67.95



8
Boker Plus
Lockback Bubinga.
\$ 59.95



9
Boker Plus
Rangebuster
Junior.
\$ 27.95



10
Boker Plus
Rangebuster.
\$ 31.95



1 BOKER PLUS EXSKELIBUR I. Mike Skellern, from South Africa, is well known among many collectors in Europe and the U.S. for his stunning pocket knives. Now we are very proud to present the Exskelibur, a collaboration custom design by Mike Skellern and Fred Burger. This piece combines elegance, high tech design and versatility in a unique way. The blue anodized titanium liner, contoured G-10 scales and an attractive red fiber spacer combine to provide a knife that feels and looks good in your hand. The horizontal satin finished blade is made of 440C stainless steel and offers, along with the hollow grind, an optimal blade for all EDC chores. The protruding blade grind allows a convenient one-hand thumb opening, and acts as a thumb ramp when the blade is open. A reversible titanium pocket clip (also blue anodized) completes this impressive package. Blade length: 3½". Overall length: 8". Weight: 3.3 oz. Item No. 01B0001 \$ 92.95

2 BOKER PLUS EXSKELIBUR II. This compact folder features all the same specifications as the Exskelibur I (above), but in a smaller size, and with a traditional nail nick for convenient opening. Blade length: 2¾". Overall length: 6½". Weight: 2.2 oz. Item No. 01B0002 \$ 67.95

3 BOKER PLUS EXSKELIBUR I MAPLE BURL. The handsome grain and warm color of the maple root wood give the Exskelibur a new and exclusive look! This new model boasts the same impressive features as the original (Item No. 01B0001), but with added elegance. The blue anodized titanium plates and pocket clip provide a stunning contrast to the maple burl. Blade length: 3½". Overall length: 8". Weight: 2.8 oz. Item No. 01B0014 \$ 148.95

4 BOKER PLUS EXSKELIBUR II MAPLE BURL. This compact folder features all the same specifications as the Exskelibur I Maple Burl (above), but in a smaller size. Blade length: 2¾". Overall length: 6½". Weight: 2 oz. Item No. 01B0015 \$ 122.95

BOKER PLUS EXSKELIMOOR. The overwhelming response to our Mike Skellern Exskelibur Series with G-10 scales (model 01B0001) brought us to the launch of this newer version. The Exskelimoor catches the eye with contoured handles made out of rustic Bog Oak, mounted on double titanium liners. The blue anodizing of the liners and clip provide an attractive contrast to the wooden scales. 440C stainless

steel, with its well known edge retention, in combination with the hollow grind, provides superior cutting capabilities. The horizontal satin finish completes the noble appearance. Available in two versions:

5 BOKER PLUS EXSKELIMOOR II. Blade length: 2¾". Overall length: 6½". Weight: 2 oz. Item No. 01B0005 \$ 92.95

6 BOKER PLUS EXSKELIMOOR I. Blade length: 3½". Overall length: 8". Weight: 3 oz. Item No. 01B0004 \$ 108.95

7 BOKER PLUS LOCKBACK EBONY. This traditional and versatile pocket knife offers an extraordinarily smooth blade action and perfectly fitted Ebony wood scales, crowned by brushed stainless steel bolsters. The classic nail nick provides comfortable opening of the 440C stainless steel blade, which locks securely with the sturdy lockback mechanism. The Ebony scales and the polished blade make this knife special, in showcase or pocket. Blade length: 2¾". Overall length: 6½". Weight: 3 oz. Item No. 01B0186 \$ 67.95

8 BOKER PLUS LOCKBACK BUBINGA. This traditional and versatile pocket knife offers an extraordinarily smooth blade action and perfectly fitted Bubinga wood scales, crowned by brushed stainless steel bolsters. The classic nail nick provides comfortable opening of the 440C stainless steel blade, which locks securely with the sturdy lockback mechanism. The Bubinga scales and the polished blade make this knife special, in showcase or pocket. Blade length: 3⅝". Overall length: 8¼". Weight: 4.5 oz. Item No. 01B0185 \$ 59.95

9 BOKER PLUS RANGEBUSTER JUNIOR. A back locking Rangebuster with a sturdy yellow poly handle and high carbon stainless steel blade. Blade length: 3". Overall length: 6⅝". Weight: 1.9 oz. Item No. 01B0021 \$ 27.95

10 BOKER PLUS RANGEBUSTER. Same specifications as model 01B0021 (above), but in a larger size. Blade length: 3½". Overall length: 7⅞". Weight: 2.9 oz. Item No. 01B0020 \$ 31.95



Boker Plus... Traditionally Classic.

1
Boker Plus
Mini Trapper.
\$ 20.95



1A
Boker Plus Mini
Trapper BK.
\$ 20.95

2
Boker Plus
Congress.
\$ 20.95

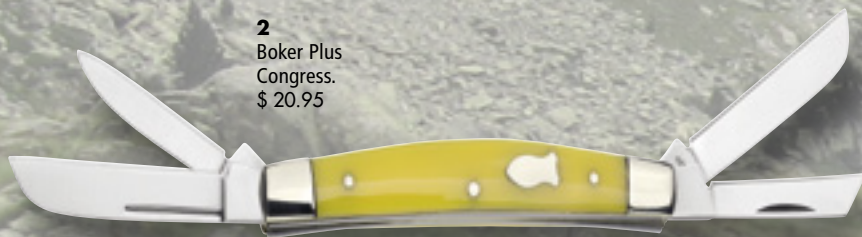

3
Boker Plus
Lock Back.
\$ 20.95



5
Boker
Plus Mini
Stockman.
\$ 20.95



4
Boker Plus
Lock Back BK.
\$ 20.95



6
Boker Plus
Stockman.
\$ 20.95



BOKER PLUS VINTAGE SERIES. With this series, Boker Plus offers the same high quality materials, well known precision in manufacturing, and the sharp look and fine details of the more modern Boker Plus knives. These traditional double bolster knives take us back to the good ol' times. Fine polished brass bolsters and synthetic handle scales with inlay for engraving. The blades are made of high performance 440C stainless steel. Available in seven models:

1 BOKER PLUS MINI TRAPPER. This useful little helper offers two blades, ideal for everyday use, and a yellow synthetic handle. Blade length: 3 1/8". Overall length: 7". Weight: 2.8 oz. Item No. 01B0294Y \$ 20.95

1A BOKER PLUS MINI TRAPPER BK. Same specifications as model 01B0294Y (above), but with a black synthetic handle. Item No. 01B0294B \$ 20.95

2 BOKER PLUS CONGRESS. This elaborate model offers four blades, for any and all tasks, and a yellow synthetic handle. Blade lengths: 2 1/8" and 1 7/8". Overall open length: 5 3/4". Weight: 1.9 oz. Item No. 01B0214Y \$ 20.95

3 BOKER PLUS LOCK BACK. Same specifications as model 01B0250B (below), but with yellow synthetic handles. Item No. 01B0250Y \$ 20.95

4 BOKER PLUS LOCK BACK BK. This model features a black synthetic handle and one handy blade, secured by a lock back. Blade length: 3". Overall length: 6 5/8". Weight: 2.5 oz. Item No. 01B0250B \$ 20.95

5 BOKER PLUS MINI STOCKMAN. The traditional Stockman pattern, in a smaller size. Yellow synthetic handle. Closed length: 3 1/4". Item No. 01B0234Y \$ 20.95

6 BOKER PLUS STOCKMAN. This addition to the Boker Plus Vintage Series features a handy leather punch and a yellow synthetic handle. Closed length: 4". Item No. 01B03380Y \$ 20.95

We revisit some pre-war patterns with the Boker Plus series of brown bone pocketknives. Impeccable quality featuring stainless steel bolsters and high carbon stainless steel blades. Scored bolsters and classic shield.

7 BOKER PLUS FAT BELLY TRAPPER. Blade length: 2 1/2". Closed length: 3 3/8". Item No. 01B0202 \$ 22.95

8 BOKER PLUS DOUBLE LOCK TRAPPER. Features a double back lock mechanism. Blade length: 3 3/8". Closed length: 4 1/4". Item No. 01B0206 \$ 24.95

7
Boker Plus Fat
Belly Trapper.
\$ 22.95



8
Boker Plus Double
Lock Trapper.
\$ 24.95



BOKER PLUS FISKMUK. Jerry Fisk is an extraordinary designer and custom knifemaker, with a goal to create a permanent value, that lasts longer than the owner or even himself. His aim is to design and build a perfect knife. Since 1987, he has continuously received the top awards for his work. Now we are proud to present to you an original Fisk folding knife design, called the Fiskmuk. Available in two versions:

9 BOKER PLUS FISKMUK STAG. The Fiskmuk was designed to provide the ultimate folding skinner for the hunter, as well as an extremely versatile general purpose knife. The premium 440C stainless steel blade has a fine satin finish and locks in the open position with a lockback. The handle has a slight belly, to fill your hand comfortably and to be used even for stronger cutting chores. This version features genuine, hand selected stag handles, perfectly fitted to the stainless steel liners and held securely in place by four rivets. Also features polished stainless steel bolsters, and an exotic blade shape that allows a variety of cutting chores. Blade length: 2¾". Overall length: 6⅝". Weight: 4 oz. Item No. 01BO031 \$ 67.95

10 BOKER PLUS FISKMUK BONE. Same features and specifications as the stag version (above), but with genuine white bone handles. Item No. 01BO030 \$ 56.95

BOKER PLUS HAWKBILL. Responding to numerous requests to revive the Boker Hawkbill, we offer two versions under the Boker Plus flagship. Both feature a 3" blade of 440C stainless steel and convenient lanyard hole. Stainless steel bolsters. Closed length: 4".

11 With jiggled brown bone handles. Item No. 01BO207 \$ 27.95

12 With black Delrin handles and classic "Miner" blade etch. Item No. 01BO208 \$ 22.95



9
Boker Plus
Fiskmuk
Stag.
\$ 67.95



10
Boker Plus
Fiskmuk
Bone.
\$ 56.95



11
Boker Plus
Hawkbill.
\$ 27.95



12
Boker Plus
Hawkbill.
\$ 22.95

BOKER PLUS



Affordable Performance:
Well known brand with attractive designs, impressive quality and an outstanding price-performance ratio. Manufactured in Taiwan and China.
[Pages 100-139]

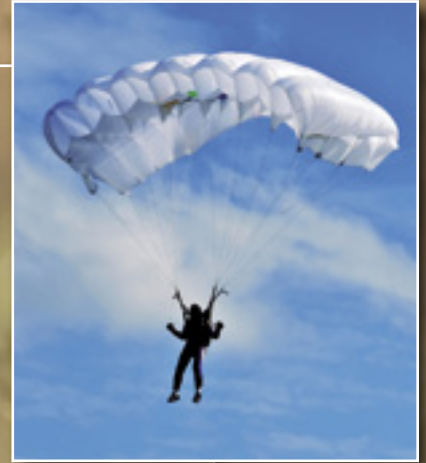

Rugged Innovations.

1 MAGNUM GOON. This heavy duty knife is like a craftsman in a tuxedo, with its streamlined, elegant look. The G-10 handle features ergonomically shaped grooves, which allow comfortable and secure handling. The massive 440 stainless steel blade is 3.4mm thick, with a partial false edge. Locks securely with a liner lock mechanism. Includes pocket clip. Blade length: 3½". Overall length: 8¼". Weight: 6.2 oz. Item No. 01EL003 \$ 42.95

2 MAGNUM X-OVER. The stonewashed 440 stainless steel blade features a drop point for a variety of cutting chores, and locks open with the sturdy liner lock mechanism. The G-10 handle provides a secure and comfortable grip. Includes pocket clip. Blade length: 3½". Overall length: 8¾". Weight: 4.6 oz. Item No. 01EL006 \$ 42.95

3 MAGNUM ALICE. Not your typical tactical knife! This eye-catching piece features a black coated blade, made of 440 stainless steel, which provides the perfect contrast to the colorful cotton candy handle. Sturdy liner lock mechanism and pocket clip for easy carry. Blade length: 3¾". Overall length: 7⅞". Weight: 4.1 oz. Item No. 01SC016 \$ 19.95

4 MAGNUM CPO. The CPO (Close Protection Officer) is the ultimate companion. The modified tanto blade is titanium coated 440 stainless steel, honed to razor sharpness. The G-10 handle has an anti-slip structure on the surface, and the finger grooves prevent slipping. Sturdy liner lock mechanism and pocket clip for easy carry. Blade length: 3¾". Overall length: 8½". Weight: 5.1 oz. Item No. 01EL012 \$ 37.95

5 MAGNUM INVESTIGATOR. A useful and sturdy knife, ideal for everyday carry. The stonewashed 440 stainless steel blade locks securely with the liner lock mechanism. The G-10 handle has an anti slip structure, and provides a comfortable grip. Includes pocket clip. Blade length: 3½". Overall length: 8¼". Weight: 5.5 oz. Item No. 01EL014 \$ 42.95

1
Magnum
Goon.
\$ 42.95

2
Magnum
X-Over.
\$ 42.95

3
Magnum
Alice.
\$ 19.95

4
Magnum
CPO.
\$ 37.95

5
Magnum
Investigator.
\$ 42.95

MAGNUM BY BOKER

M MAGNUM
by BOKER

NEW



1
Magnum
Classic
Pocket Steel.
\$ 19.95

NEW



2
Magnum
Damascus
Stubby.
\$ 109.95

NEW



3
Magnum
Mistress.
\$ 59.95

NEW



4
Magnum
Lift 'N Lock.
\$ 54.95



5
Magnum
Pearl Traveler.
\$ 27.95

1 MAGNUM CLASSIC POCKET STEEL.

A useful and handy pocket knife. The blades, cap lifter and can opener are made of 440 stainless steel, and the handle is handsome rosewood. The steel bolsters and ring can be used to attach a lanyard or knife chain. Blade length: 2½". Overall length: 6¼". Weight: 2.9 oz. Item No. 01MB334 \$ 19.95

2 MAGNUM DAMASCUS STUBBY.

This small and handy knife fits in any pocket or purse. The stout blade is made of 37 layers of Damascus, and locks open with the sturdy liner lock mechanism. The handle is a handsome, dark ebony wood, which provides the perfect contrast with the Damascus bolster. Blade length: 2¾". Overall length: 5¾". Weight: 3.6 oz. Item No. 01MB178DAM \$ 109.95

3 MAGNUM MISTRESS.

A premium knife everyone will be jealous of! The blade is made of 37 layers of steel, and the bolster is Damascus as well. For

the handles, we chose handsome Mediterranean olive wood. Secure lockback mechanism. Does not have pocket clip. Blade length: 2¾". Overall length: 5½". Weight: 2.3 oz. Item No. 01MB171DAM \$ 59.95

4 MAGNUM LIFT 'N LOCK.

This innovative and handy knife combines classic elegance with an ingenious technique. The 37-layer Damascus blade and Mediterranean olive wood handle combine to make this a stunning piece. A special point of interest is the locking mechanism - to fold the blade back into the handle, just lift the metal ring to unlock. Also features a keyring for easy carry. Blade length: 1¾". Overall length: 4". Weight: 0.9 oz. Item No. 01MB289DAM \$ 54.95

5 MAGNUM PEARL TRAVELER.

This compact piece is ideal for the small emergencies in everyday life, or on the road. The blade, made of 440 stainless steel, is perfect for opening

boxes, cutting threads, packing straps, or peeling an apple on your lunch break. The mini scissors, nail cleaner and file makes it all the more practical. The pocket clip keeps it handy, or can be used as a money clip. The slim handle is made of stainless steel and Mother-of-Pearl. Blade length: 2⅛". Overall length: 5". Weight: 1.8 oz. Item No. 01LL100 \$ 27.95

6 MAGNUM BACKPACKER.

A handsome and useful knife for your next trip. The 440 stainless steel blade has a rich satin finish and is flat ground for excellent cutting performance. The blade locks open with the sturdy liner lock. The grain of the wooden handle adds a rustic touch. Pocket clip and lanyard hole for easy carry. Blade length: 2¾". Overall length: 7¾". Weight: 3.8 oz. Item No. 01EL605 \$ 27.95

7 MAGNUM BARON.

Distinctive, discreet and reliable. The wooden handle features four decorative holes, and the blade, made of 440 stainless steel, locks open with the sturdy liner lock. The pocket clip allows convenient carry. Blade length: 2¾". Overall length: 6½". Weight: 2.5 oz. Item No. 01EL011 \$ 22.95

8 MAGNUM ZEBRA.

The wide handle and bellied, hollow ground blade make this piece the perfect cutting tool for lunch, work, or everyday carry. The blade is 440 stainless steel, and the handsome handle features an attractive wood grain. Sturdy lockback mechanism. Blade length: 3". Overall length: 6½". Weight: 2.5 oz. Item No. 01MB846 \$ 23.95

NEW

NEW

6
Magnum
Backpacker.
\$ 27.95

7
Magnum
Baron.
\$ 22.95

NEW

NEW

8
Magnum
Zebra.
\$ 23.95

9
Magnum
Jewel.
\$ 14.95

NEW

NEW

10
Magnum
Caveman.
\$ 49.95

11
Magnum
Outdoorsman.
\$ 79.95

9 MAGNUM JEWEL. The value of this fine knife is reflected by its name. The polished 440 stainless steel blade locks securely with the lockback mechanism, and the dark rosewood handle harmonizes perfectly with the polished metal bolsters. Small in your pocket, but big in versatility! Blade length: 2½". Overall length: 5¾". Weight: 1.6 oz.
Item No. 01MB318 \$ 14.95

10 MAGNUM CAVEMAN. A classic lockback pocket knife. Features a 37-layer Damascus steel blade and wooden handle adorned with a primitive hunting scene, reminiscent of cave art, making it truly unique. Blade length: 3¼". Overall length: 7½". Weight: 4.2 oz.
Item No. 01RY817 \$ 49.95

11 MAGNUM OUTDOORSMAN. The cousin to the Caveman (model 01RY817 above), featuring a 37-layer Damascus steel blade and a rugged, hand selected stag handle. Sturdy lockback mechanism. Blade length: 3¼". Overall length: 7½". Weight: 4.2 oz.
Item No. 01RY817DAM \$ 79.95

MAGNUM BY BOKER

M MAGNUM
by BOKER

High tech style.

NEW



1
Magnum Drive.
\$ 22.95

NEW



2
Magnum Techno Drill.
\$ 19.95

NEW



3
Magnum Wanderer.
\$ 44.95

NEW



4
Magnum Contender.
\$ 29.95

1 MAGNUM DRIVE. This elegant knife features a 440 stainless steel blade with a fine satin finish, which locks securely with the liner lock mechanism. The pakkawood handle, with its attractive red hue, harmonizes perfectly with the black Micarta bolster. Includes removable pocket clip. Blade length: 3½". Overall length: 7½". Weight: 3.6 oz. Item No. 01GL111 \$ 22.95

2 MAGNUM TECHNO DRILL. The lightweight construction makes the Techno Drill a comfortable and reliable companion. The black coated 440 stainless steel blade and detachable pocket clip provide versatility and functionality. Also features slip resistant G-10 handles on blue anodized liners. Sturdy liner lock mechanism. Blade length: 2¾". Overall length: 6½". Weight: 2.1 oz. Item No. 01LL318 \$ 19.95

3 MAGNUM WANDERER. This high quality folding knife is ideal for backpackers, hikers, and outdoor enthusiasts. The G-10 handles feature anti-slip texturing, and an earthy brown tone. The 440 stainless steel blade has a titanium coating, and a second choil for precise cutting tasks. The oversized pivot offers maximum strength. Liner lock mechanism. Blade length: 3½". Overall length: 8¼". Weight: 5.7 oz. Item No. 01EL015 \$ 44.95

4 MAGNUM CONTENDER. This beefy knife features a bellied 440 stainless steel blade that can handle any cutting chore. The brushed stainless steel bolster accents the intricate gray and black handle, which sits perfectly in the hand and provides excellent control. Liner lock mechanism. Blade length: 3¼". Overall length: 7¾". Weight: 5.3 oz. Item No. 01RY196 \$ 29.95

5 MAGNUM CODE GRAY. This sturdy yet stylish folder proves that design and durability can go hand in hand. The gray anodized aluminum handle is lightweight and provides the ultimate stability. The high performance 440C stainless steel blade and sturdy liner lock mechanism guarantee high operational safety. Blade length: 3¼". Overall length: 7¾". Weight: 3.6 oz. Item No. 01MB103 \$ 25.95

5
Magnum
Code Gray.
\$ 25.95

6 MAGNUM SHADOWSEEKER. A strong and sleek companion. The titanium coated 440 stainless steel blade locks securely with the liner lock mechanism. The complex Micarta handle features grooves and circles, CNC machined into the surface, which makes handling very comfortable and secure. Includes pocket clip. Blade length: 3½". Overall length: 8¼". Weight: 5.7 oz. Item No. 01EL017 \$ 46.95

6
Magnum
Shadowseeker.
\$ 46.95



MAGNUM DETONATION SERIES. This new series offers an unusual blade finish, with the so-called "blast camo," which protects from corrosion and light reflection on the 440 stainless steel blades. The irregular, geometric anthracite particles on the black blades make each knife truly unique. A knife for heavy duty work, indoors and out - the Detonation will not let you down. Includes pocket clip. Available in three models:

7 MAGNUM DETONATION I. With drop point blade, pronounced ricasso and sturdy G-10 handle scales for a secure grip. Blade length: 3¾". Overall length: 8". Weight: 5.5 oz. Item No. 01MB285 \$ 31.95

7
Magnum
Detonation I.
\$ 31.95

8 MAGNUM DETONATION II. With intricately cut tanto style blade and sturdy G-10 handle scales for a secure grip. Blade length: 3¼". Overall length: 7⅞". Weight: 5.8 oz. Item No. 01MB977 \$ 31.95

8
Magnum
Detonation II.
\$ 31.95

9 MAGNUM DETONATION III. With tanto style blade and lightweight, perforated stainless steel handle, titanium coated. Blade length: 3¾". Overall length: 7⅞". Weight: 5.1 oz. Item No. 01MB801 \$ 28.95

9
Magnum
Detonation III.
\$ 28.95



MAGNUM BY BOKER





NEW

1 Magnum Slicer.
\$ 31.95



NEW

2 Magnum Griptech.
\$ 29.95



NEW

3 Magnum Savior.
\$ 22.95



NEW

4 Magnum Smokejumper.
\$ 19.95

1 MAGNUM SLICER. This impressive knife can handle any task. The 440 stainless steel blade locks securely with the liner lock mechanism, and the intricately machined G-10 handle scales will withstand all weather conditions and provide a comfortable and secure grip. Includes pocket clip. Blade length: 3¾". Overall length: 8". Weight: 5.5 oz. Item No. 01MB201 \$ 31.95

2 MAGNUM GRIPTECH. A handy folding knife, with a comfortable G-10 handle with grooves for added grip security. The titanium coated 440 stainless steel blade locks with the secure lockback mechanism. Includes pocket clip. Blade length: 3½". Overall length: 8". Weight: 5.3 oz. Item No. 01MB202 \$ 29.95

3 MAGNUM SAVIOR. This knife can tackle any task in an emergency situation. The black coated 440 stainless steel blade, featuring a seatbelt cutter, can be easily opened and locks in place with the sturdy liner lock. The checkered aluminum handle provides a secure grip. Includes pocket clip. Blade length: 3¾". Overall length: 8¾". Weight: 5.6 oz. Item No. 01RY772 \$ 22.95

4 MAGNUM SMOKEJUMPER. This knife honors the courage of the professionals who risk their lives during their dangerous duties. The 440 stainless steel blade boasts a two-tone finish, and locks securely with the liner lock mechanism. The heavy duty aluminum handle proudly carries the Fire Department emblem. The glass breaker, seatbelt cutter, and partial

serrations offer maximum functionality. Includes pocket clip. Blade length: 3⅝". Overall length: 7¾". Weight: 4.8 oz. Item No. 01RY769 \$ 19.95

5 MAGNUM A-STAN. A sturdy tactical knife, made for the harsh duties overseas. The desert G-10 handle and titanium coated 440 stainless steel blade are mission ready. The blade is easily opened with the flipper, even with gloves on, and locks securely with the liner lock mechanism. The pocket clip keeps it easily accessible, and the lanyard hole allows you to strap it to your gear. Blade length: 3¾". Overall length: 8¼". Weight: 5.5 oz. Item No. 01EL001 \$ 39.95

6 MAGNUM TEAM LEADER. A real authority. This knife features a titanium coated 440 stainless steel blade that locks securely with the liner lock mechanism. The G-10 handle features a coarse anti-slip texture. The back of the handle offers additional functionality,

with a seatbelt cutter, cap lifter, and a flat head screwdriver - all lockable. Also features a glass breaker and lanyard hole. Blade length: 3⅝". Overall length: 7¾". Weight: 5.1 oz. Item No. 01EL002 \$ 49.95

7 MAGNUM BOWIE FLASH. This functional and compact knife features a titanium coated 440 stainless steel blade that locks securely with the liner lock mechanism. For added versatility, the distance of the thumb stud to the pivot can be adjusted. The G-10 handle offers a firm and secure grip. Includes pocket clip. Blade length: 3¼". Overall length: 7½". Weight: 4.1 oz. Item No. 01GL110 \$ 36.95

8 MAGNUM RECURVE FLASH. This functional and compact knife features a titanium coated 440 stainless steel blade that locks securely with the liner lock mechanism. The innovative CNC machined G-10 handle provides a safe and secure grip for heavy duty tasks. Includes pocket clip. Blade length: 3¼". Overall length: 7½". Weight: 4.1 oz. Item No. 01GL109 \$ 34.95

NEW

5
Magnum
A-Stan.
\$ 39.95



NEW



6
Magnum
Team Leader.
\$ 49.95

NEW



7
Magnum
Bowie Flash.
\$ 36.95

NEW



8
Magnum
Recurve
Flash.
\$ 34.95

NEW

9
Magnum
Desert
Mission.
\$ 24.95



9 **MAGNUM DESERT MISSION.** A handy and reliable knife for any task. The blade, made of 440 stainless steel, can be opened with the flipper or the thumb stud with just one hand. The desert G-10 handle features an anti-slip rubber insert for maximum grip. Includes pocket clip. Blade length: 3 1/8". Overall length: 7 3/4". Weight: 4.1 oz. Item No. 01GL006 \$ 24.95

NEW

10 **MAGNUM JUNGLE MISSION.** Same features and specifications as the Desert Mission (model 01GL006), but with an olive drab handle. Blade length: 3 1/8". Overall length: 7 3/4". Weight: 4.1 oz. Item No. 01GL005 \$ 24.95



10
Magnum
Jungle
Mission.
\$ 24.95

MAGNUM BY BOKER

M MAGNUM
by BOKER

NEW



1 Magnum Timberman. \$ 44.95

NEW



2 Magnum Exchange. \$ 32.95

3 Magnum Commander. \$ 35.95



4 Magnum Mission Commander. \$ 35.95



1 MAGNUM TIMBERMAN. The perfect knife for any craftsman. The finely honed blade, made of 440 stainless steel, has a tip like a chisel, which is perfect for smoothing a surface, or cleaning/removing adhesive materials. The G-10 handle has a tool set in for loosening hexagon head screws (4mm to 10mm). Also features a glass breaker and pocket clip. Blade length: 3³/₈". Overall length: 8". Weight: 5.4 oz. Item No. 01RY144 \$ 44.95

2 MAGNUM EXCHANGE. The dark olive drab G-10 handle not only offers the perfect grip, it also carries the pocket clip, which can be switched from left to right side carry in seconds. Secured by a clever mechanism rather than screws, the pocket clip is securely connected to the knife, and can be easily changed with the tip of a ball point pen or similar tool. The recurved blade is made of 440 stainless steel

and is titanium coated. The deep CNC machined grooves and lanyard hole make it the perfect all around companion. Blade length: 3¹/₄". Overall length: 7⁷/₈". Weight: 4.7 oz. Item No. 01SC562 \$ 32.95

3 MAGNUM COMMANDER. A knife that guarantees success, wherever you go. The tanto style blade is made of corrosion resistant 440C stainless steel with anthracite coating, and a hollow groove with multiple drillings for weight reduction. The handle scales are crafted of an ergonomically shaped and extremely slip resistant synthetic material, G-10, which provides maximum stability. Also features a sturdy frame lock mechanism, lanyard hole and pocket clip. Blade length: 3¹/₈". Overall length: 7³/₄". Weight: 5.7 oz. Item No. 01SC932 \$ 35.95

4 MAGNUM MISSION COMMANDER. Same impressive features as model 01SC932 (above), but with a drop point blade and coyote handle. Blade length: 3¹/₈". Overall length: 7³/₄". Weight: 5.5 oz. Item No. 01SC931 \$ 35.95

5 MAGNUM POCKET KUKRI. This monstrous knife feels like a pocket sword. Fold out the 440 stainless steel blade and you will feel the power of this impressive folder. Perfect for light chopping or carving, or any other outdoor task. The blade locks securely with the liner lock mechanism, and the handle is crafted of G-10 with stainless steel liners. Lanyard hole. Blade length: 4⁵/₈". Overall length: 10³/₈". Weight: 7.5 oz. Item No. 01MB511 \$ 28.95

6 MAGNUM HUNCHBACK. The curved handle of the Hunchback is made of high strength aluminum and

lies comfortably in the hand. The Kraton insets provide superior grip, and the finely blasted tanto style blade can handle any cutting task. Features a liner locking mechanism, removable thumb disc, lanyard hole and pocket clip (tip-down carry). Blade length: 3¹/₄". Overall length: 8". Weight: 4.6 oz. Item No. 01MB101 \$ 28.95

7 MAGNUM SPECIAL FORCES KARAMBIT. This discreet black Karambit, with a high performance 440C stainless steel blade, locks safely with a sturdy liner locking mechanism. Due to the ring shaped flipper for opening the blade, and the ring at the handle end, this knife will lie comfortably in your hand, even in adverse weather conditions. The black aluminum handle scales are enhanced with a Special Forces emblem. Includes pocket clip. Blade length: 3". Overall length: 8¹/₂". Weight: 4.6 oz. Item No. 01MB400 \$ 29.95

8 MAGNUM WHIRLWIND. A tactical Karambit with flipper and blade hole for quick and safe opening. The typical opening at the end of the handle offers maximum stability, and the black G-10 handle scales provide optimum handling. The blade is high



5
Magnum
Pocket Kukri.
\$ 28.95



6
Magnum
Hunchback.
\$ 28.95



7
Magnum
Special Forces
Karambit.
\$ 29.95



8
Magnum
Whirlwind.
\$ 29.95



9
Magnum LE.
\$ 24.95

performance 440C stainless steel, black coated. Liner lock mechanism. Includes pocket clip (tip-down carry). Blade length: 3". Overall length: 8³/₈". Weight: 4.3 oz.
Item No. 01MB600 \$ 29.95

9 MAGNUM LE. An extraordinary knife! The slim blade, made of 440C stainless steel, is clearly longer than the handle. Thanks to an ingenious technology, the knife can be handled in the closed position despite the unusual proportions. A blade protection mechanism automatically slides out of the handle when the knife is folded, and covers the tip of the blade. The black anodized aluminum handle features a liner locking mechanism and law enforcement emblem. Blade length: 5". Overall length: 9³/₄". Weight: 5.1 oz.
Item No. 01MB102 \$ 24.95

MAGNUM BY BOKER

M MAGNUM
by BOKER

Fixed Force.

1
Magnum
Escape Knife.
\$ 27.95



2
Magnum Neck
Flash.
\$ 24.95



3
Magnum
Backup.
\$ 31.95



4
Magnum Tanto
Neck Knife.
\$ 34.95



1 MAGNUM ESCAPE KNIFE. A general back-up knife for everyday use that gives you cutting power at your fingertips in a convenient size, small enough to be carried on almost any part of your equipment or clothing. This easy-to-use cutting tool features a 2" blade of 420 stainless steel and black Micarta handle. Weighs just under 1 oz. Includes black leather sheath with boot clip. Overall length: 4³/₈". Item No. 02B0550 \$ 27.95

2 MAGNUM NECK FLASH. Neck knives are comfortable and easy to carry all day long. The skeleton handle has a non-slip rubber coating and the sheath is made of indestructible ABS plastic. Blade length: 2⁷/₈". Overall length: 6¹/₂". Weight: 1.7 oz. Item No. 02MB210 \$ 24.95

3 MAGNUM BACKUP. This compact, easy to carry knife is the perfect plan B. The satin finished 440 stainless steel blade is sharpened on both sides, featuring a partial serration, is grooved and finely ground. The massive handle is made of stainless steel plates and Micarta, and the holes provide the perfect balance. Includes a plastic sheath with clip. Blade length: 3⁷/₈". Overall length: 7¹/₂". Weight: 4.6 oz. Item No. 02SC015 \$ 31.95

4 MAGNUM TANTO NECK KNIFE. A lightweight tanto knife for all cutting tasks. This neck knife is extremely durable, due to its one piece construction, and weighs just 2.2 oz. 440 stainless steel blade and durable G-10 handles. Includes Kydex sheath and ball chain. Compatible with our Mini Tek-Lok (not included). Blade length: 3". Overall length: 6³/₄". Item No 02MB1026 \$ 34.95

5 MAGNUM BUSH BUDDY. This knife is especially designed for hardcore missions. As a work knife or in emergency situations, it won't let you down! The modified tanto blade, made of 440 stainless steel, boasts a satin finish, and the orange G-10 handles provide a comfortable and secure grip, while being highly visible in low light situations. Includes a Kydex sheath with a mounting clip for various carrying positions. Blade length: 5". Overall length: 9⁵/₈". Weight: 8.9 oz. Item No. 02YA150 \$ 66.95

6 MAGNUM URBAN KING. A stout and impressive knife, that will take on any challenge. The massive blade,

made of 440 stainless steel, has an impressive thickness of 5mm and runs completely through the handle. The anti slip G-10 handle feels secure, even in harsh weather conditions. Includes a Kydex sheath with a multi-position clip. Blade length: 4³/₄". Overall length: 9¹/₂". Weight: 10 oz. Item No. 02YA147 \$ 67.95

7 MAGNUM TWISTER. An unusual dagger, almost from a different era. The short dagger blade, made of 440 stainless steel, has a full tang for added strength and weight. The stylish black wood handle features a robust lanyard hole. Includes leather sheath. Blade length: 2¹/₂". Overall length: 9¹/₄". Weight: 6.6 oz. Item No 02RY149 \$ 35.95

8 MAGNUM DESERT WARRIOR. The ideal companion for every mission. The massive, black coated 440 stainless steel blade offers superior strength, due

to the grip end. The Micarta handle scales are screwed together with milled grooves in the handle, and the slightly bulbous spear point blade has a ricasso for added cutting power. Includes a black nylon military sheath. Blade length: 6³/₄". Overall length: 12". Weight: 14 oz. Item No 02SC010 \$ 72.95

9 MAGNUM KHUCOM. This extremely durable Kukri can handle anything. The 440 stainless steel blade is 7mm thick and offers full tang construction. The flat Micarta scales lie comfortably in the hand and provide a secure grip. The sturdy Kydex sheath is compatible with our Tek-Lok (model 09B0505, not included), or with a piece of paracord (not included) on the belt. Whether chopping or cutting, the Khucom will be helpful in any situation! Blade length: 6¹/₂". Overall length: 11³/₄". Weight: 19.5 oz. Item No 02MB523 \$ 103.95

NEW



5
Magnum
Bush Buddy.
\$ 66.95

NEW



6
Magnum
Urban King.
\$ 67.95



7
Magnum
Twister.
\$ 35.95



8
Magnum
Desert
Warrior.
\$ 72.95

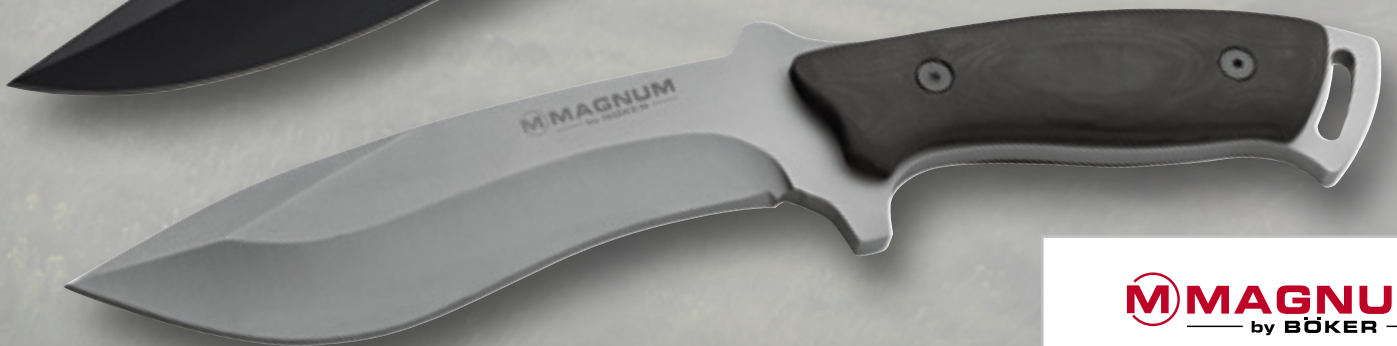

9
Magnum
Khucom.
\$ 103.95

MAGNUM BY BOKER

M MAGNUM
by BOKER



1
Magnum La
Fleur.
\$ 22.95



2
Magnum
Padre.
\$ 24.95



3
Magnum
Grace I.
\$ 23.95



4
Magnum
Grace II.
\$ 22.95



5
Magnum
Lockback
Hunter.
\$ 22.95

1 MAGNUM LA FLEUR. What a beauty! This elegant pocket knife features etched arabesques on the 440 stainless steel blade, and elaborately inserted inlays on the handle. Sturdy lockback mechanism. Blade length: 2⁵/₈". Overall length: 6". Weight: 2.1 oz. Item No. 01RY720 \$ 22.95

2 MAGNUM PADRE. This classic lockback folding knife goes back to the roots. The traditional nail nick in the 440 stainless steel blade, the lockback mechanism, and the engraving plate in the black stabilized wood handle make this piece a classic. No pocket clip or lanyard hole is needed with this exceptional everyday folder. The stainless steel bolsters enhance the traditional look. Blade length: 3¹/₄". Overall length: 7³/₈". Weight: 3 oz. Item No. 01MB004 \$ 24.95

3 MAGNUM GRACE I. A piece of jewelry for your pocket, with a great price performance. The bolsters display a unique etching, and are in great harmony with the dark cocobolo wood handles. The lock back secures the 440 stainless steel blade in the open position. Overall length: 8¹/₄". Blade length: 3¹/₂". Weight: 4.3 oz. Item No. 01YA109 \$ 23.95

4 MAGNUM GRACE II. An eye-catcher, with two insets of laminated wood integrated into the stainless steel handle with an attractive etching. Locks securely in the open position with the lock back. Overall length: 8". Blade length: 3¹/₂". Weight: 4.8 oz. Item No. 01YA110 \$ 22.95

5 MAGNUM LOCKBACK HUNTER. With classic etched bolsters. Pakkawood handles with a 3⁵/₈" clip point blade of 420 stainless steel. Overall open length: 8⁵/₈". Weight: 6 oz. Item No. 01SC002 \$ 22.95

6 MAGNUM QUARTETT. This classic and stylish piece will never leave your pocket. A traditional slip joint pocket knife featuring four blades made of 440 stainless steel, with a matte finish. The handle scales are crafted of handsome buffalo horn, with an engravable inlay on the front scale. The compact size allows convenient pocket carry. Blade length: 2³/₈". Overall length: 6¹/₈". Weight: 3 oz. Item No. 01LL293 \$ 18.95

7 MAGNUM DAMASCUS CUISINE. The perfect piece for a stylish snack on the go! The blade, fork and handle are made of 37-layer Damascus steel, for that unique style. Fold it up for easy carry. Make your friends jealous with this exquisite tableware! Blade length: 3¹/₂". Closed length: 4¹/₂". Weight: 2.7 oz. Item No. 01MB803DAM \$ 109.95

8 MAGNUM FLEET STREET RAZOR. An extraordinary and robust folder. The shape and finish are reminiscent of a classic straight razor, yet this piece has superior stability for added versatility. The blade and handle are made of 440 stainless steel with intricate decoration. No locking mechanism. Blade length: 4⁷/₈". Overall length: 10¹/₂". Weight: 6.1 oz. Item No. 01LG242 \$ 25.95

6
Magnum
Quartett.
\$ 18.95



NEW

7
Magnum
Damascus
Cuisine.
\$ 109.95



8
Magnum Fleet
Street Razor.
\$ 25.95



9 **MAGNUM POCKET BUDDY.** A handy knife for any occasion. The 440 stainless steel blade can be opened with the nail nick, and secured with the sturdy lock back mechanism. The satin finished bolster provides the perfect contrast to the sleek black Pakka wood handle. Does not have pocket clip. Blade length: 3". Overall length: 7 1/8". Weight: 3.4 oz. Item No. 01MB631 \$ 29.95

NEW

9
Magnum
Pocket
Buddy.
\$ 29.95



NEW

10 **MAGNUM FAVORITE.** Meet your new favorite pocket knife. The gentle curves, 440 stainless steel blade and handsome rosewood handle with brass pins provide a simple elegance. Sturdy lockback mechanism. Blade length: 3". Overall length: 6 7/8". Weight: 2.4 oz. Item No. 01MB051 \$ 20.95

10
Magnum
Favorite.
\$ 20.95



NEW

11 **MAGNUM BIG WOODS.** Perfect for any outdoor activity. The finely polished 440 stainless steel blade locks open with the sturdy lockback mechanism. The massive stainless steel bolster offers balance and elegance, and harmonizes with the dark rosewood handle. Does not have pocket clip. Blade length: 4". Overall length: 9 1/8". Weight: 5.4 oz. Item No. 01LL211 \$ 25.95

11
Magnum Big
Woods.
\$ 25.95

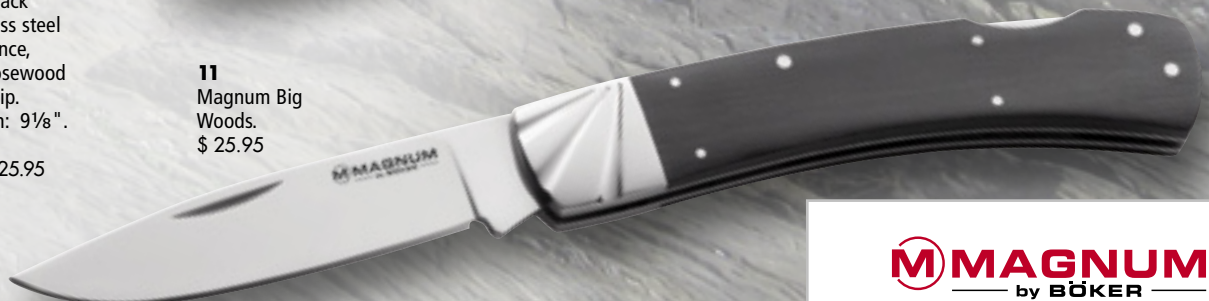

MAGNUM BY BOKER

M MAGNUM
by BOKER

Superior Style.

1
Magnum Agent.
\$ 20.95



2
Magnum Power Trooper.
\$ 31.95



3
Magnum Urban Tank.
\$ 31.95



4
Magnum Great Knight.
\$ 31.95



5
Magnum Thunderbolt.
\$ 24.95



1 MAGNUM AGENT. This compact all-black knife is ready for any mission. G-10 handles, 440 stainless steel blade and liner locking mechanism. Reversible pocket clip for right or left hand carry. Overall length: 7¹/₈". Blade length: 3¹/₈". Weight: 2.9 oz. Item No. 01RY901 \$ 20.95

2 MAGNUM POWER TROOPER. Large, sleek and elegant design. Features a 440 stainless steel blade, black G-10 scales and pocket clip. Liner locking mechanism. Overall length: 10³/₄". Blade length: 4³/₄". Weight: 6 oz. Item No. 01MB219 \$ 31.95

3 MAGNUM URBAN TANK. This massive knife is dressed to impress. Holes in the handles provide an extra secure grip, and the versatile black-coated 440 stainless steel blade can be opened with the thumb stud or the guard. Includes pocket clip and lanyard hole. Overall length: 10³/₄". Blade length: 4²/₃". Weight: 7.6 oz. Item No. 01MB222 \$ 31.95

4 MAGNUM GREAT KNIGHT. Traditional dagger style blade with a one-sided edge – a classic style for centuries. The blade is made of 440 stainless steel with a bead blast finish,

and can be opened lightning-fast with the handy guards. G-10 handles, liner locking mechanism. Includes pocket clip and lanyard hole. Overall length: 10²/₃". Blade length: 4²/₃". Weight: 5.4 oz. Item No. 01MB221 \$ 31.95

5 MAGNUM THUNDERBOLT. The double-sided handguards on the corrosion resistant 440 stainless steel blade perform dual tasks – not only can the blade be opened lightning-fast by a flip of the handguard, but it also prevents the hand from slipping onto the single-edged dagger style blade. The large black handle offers a

secure, comfortable grip, and allows for various carrying options. Includes pocket clip. Blade length: 3³/₄". Overall length: 8³/₄". Weight: 4.5 oz. Item No. 01RY542 \$ 24.95

6 MAGNUM CHANNEL. A truly handsome pocket knife. The coated 440 stainless steel blade locks securely with the liner lock mechanism, and the scored steel bolsters add a stylish touch. The wooden scales provide character, and comfort in your hand. Includes pocket clip and lanyard hole. Blade length: 3¹/₈". Overall length: 7⁵/₈". Weight: 4.5 oz. Item No. 01MB002 \$ 28.95

7 MAGNUM PIONEER. This full size folder is suited for a variety of cutting chores. Whether you are a backpacker, a craftsman, or you just need a reliable knife in your pocket for everyday use, this will do the job. The 440 stainless steel drop point blade has a big belly,

6
Magnum
Channel.
\$ 28.95



7
Magnum
Pioneer.
\$ 31.95



8
Magnum
Defilade.
\$ 24.95



9
Magnum
Winter Camo.
\$ 24.95



10
Magnum
Ring-O.
\$ 51.95



11
Magnum
Bulldog.
\$ 24.95

even for hunting chores, and is secured by a sturdy liner lock. The stainless steel bolsters and black Micarta scales provide a secure and comfortable grip. Includes pocket clip and lanyard hole for easy carry. Blade length: 3 1/8". Overall length: 7 5/8". Weight: 5.6 oz. Item No. 01MB761 \$ 31.95

8 MAGNUM DEFILADE. Complement your camo hunting gear with this lightweight 440 stainless steel liner lock. The handle is made of lightweight aluminum, and teams up with the titanium coated blade, for additional protection. With lanyard hole and pocket clip. Blade length: 3". Overall length: 7 1/8". Weight: 3.2 oz. Item No. 01MB357BM \$ 24.95

9 MAGNUM WINTER CAMO. This unique model boasts the exceptional winter camo pattern on the lightweight aluminum handle scales, and a black coated 440 stainless steel blade. Liner locking mechanism and pocket clip. Blade length: 3 3/8". Overall length: 7 3/4". Weight: 3.5 oz. Item No. 01RY136 \$ 24.95

10 MAGNUM RING-O. This piece is truly unique! The oddly shaped 440 stainless steel blade rotates around the camp, and is arrested by the sturdy liner lock. The rugged G-10 handle scales provide a firm and secure grip. Includes pocket clip for easy carry. Blade length: 3 1/4". Overall length: 7 3/4". Weight: 5 oz. Item No. 01LL325 \$ 51.95

11 MAGNUM BULLDOG. Put this in your hand and you know you are carrying a real knife. 440 stainless steel blade and sturdy G-10 handle scales. Easy one-hand open and close. This massive

blade guarantees effective field work! Includes pocket clip. Blade length: 3 1/2". Overall length: 8". Weight: 6.3 oz. Item No. 01YA073 \$ 24.95

MAGNUM BY BOKER



1
Magnum
Exquisite
Lock Back.
\$ 56.95



1 MAGNUM EXQUISITE LOCK BACK II. This classic features genuine stag handles, nickel silver bolsters and a 440 stainless steel blade. Blade length: 2¾". Overall length: 6½". Weight: 3.8 oz. Item No. 01GL804 \$ 56.95

2
Magnum Classic
Hunter.
\$ 32.95



2 MAGNUM CLASSIC HUNTER. A traditional hunting pocket knife. All three blades are made of 440 stainless steel, and each has its own lock, which prevents accidental closing. This versatile piece sports a bowie style blade, a gut hook, and a saw blade - ideal for use on wood or bone. The Pakka wood scales in contrast with the brushed stainless steel bolsters create an attractive hunter's companion. A truly versatile knife for your next hunting, trekking, or outdoor trip. Blade length: 3½". Overall length: 8". Weight: 9.7 oz. Item No. 01MB136 \$ 32.95

3
Magnum
Forest Ranger.
\$ 24.95



3 MAGNUM FOREST RANGER. This mighty and impressive knife can handle any cutting task with ease. The satin finished 440 stainless steel clip point blade is secured by a liner lock, and the stainless steel bolsters and attractive burl wood scales add an elegant touch. The screw-fastened pocket clip provides comfortable carry and easy access. Blade length: 3¾". Overall length: 9¼". Weight: 6.6 oz. Item No. 01MB233 \$ 24.95

4
Magnum
Hawk.
\$ 24.95

4 MAGNUM HAWK. This rugged work knife will stand up to any cutting chore. The handle is a combination of satin finished stainless steel and an elegant grained wood. The straight spearpoint blade is made of 440 stainless steel and is secured by a reliable liner lock. Includes pocket clip. Blade length: 3⅜". Overall length: 7¾". Weight: 4.8 oz. Item No. 01MB042 \$ 24.95



5 MAGNUM REFLECTION. A complement to our Magnum line, featuring a mirror polished frame and a blade made of 440 stainless steel with the warmth of attractive wooden scales. Liner locking mechanism. Overall length: 9". Blade length: 4". Weight: 4.7 oz. Item No. 01RY6182 \$ 24.95



5
Magnum
Reflection.
\$ 24.95

NEW



6
Magnum
Grandpa.
\$ 25.95

6 MAGNUM GRANDPA. A traditional yet charismatic knife. The classic faux tortoise handle harmonizes perfectly with the brass bolster, and the two large blades, made of 440 stainless steel, can be opened with the nail nick - just like in Grandpa's times. Blade length: 2¾". Overall length: 7". Weight: 5.1 oz.
Item No. 01LL210 \$ 25.95

NEW

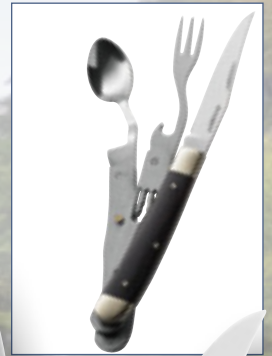

7
Magnum
Bon
Appetite.
\$ 25.95

7 MAGNUM BON APPETITE. A complete and compact set of utensils, perfect for camping, hiking, or a snack on the go. The knife, fork and spoon are made of 440 stainless steel, and the innovative locking mechanism allows you to operate each tool individually. The black wood handle adds a classic look. Blade length: 3⅜". Overall length: 7⅜". Weight: 2 oz.
Item No. 01LL209 \$ 25.95

8 MAGNUM BUSH COMPANION. A heavy duty working knife. The liner lock secures the blade in the open position. The 440 stainless steel blade has a big belly, perfect for hunting chores. Pakka wood handles. Blade length: 3⅞". Overall length: 8⅞". Weight: 7.5 oz.
Item No. 01YA116 \$ 22.95

9 MAGNUM PADAUK. This massive 440 stainless steel blade and pocket clip for easy carry. Blade length: 4⅜". Overall length: 9⅝". Weight: 9 oz.
Item No. 01YA017 \$ 34.95

8
Magnum Bush
Companion.
\$ 22.95



9
Magnum
Padauk.
\$ 34.95



MAGNUM BY BOKER

Outward Bound.

1
Magnum Skinner.
\$ 44.95

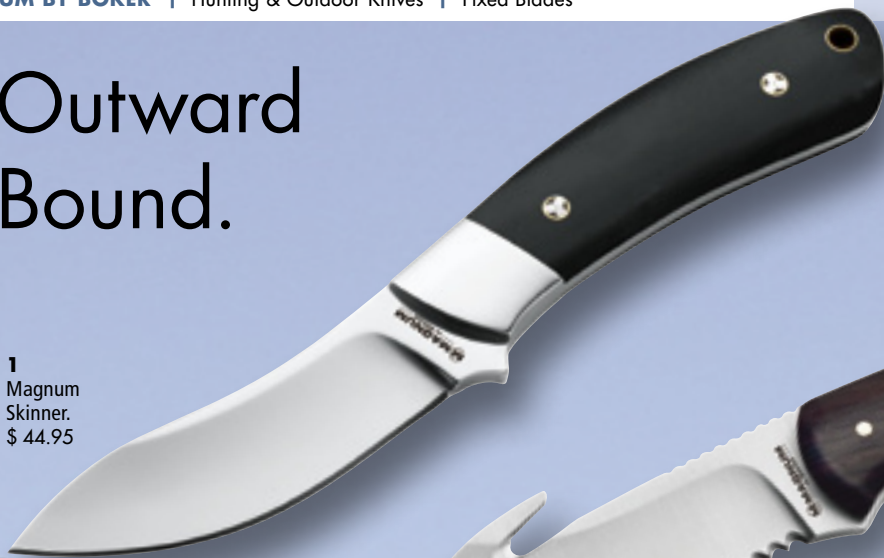

2
Magnum Hunter's Hook.
\$ 35.95



NEW

3
Magnum Back Country Subhilt Micarta.
\$ 70.95



NEW

4
Magnum Back Country Subhilt Stag.
\$ 103.95



4 **MAGNUM BACK COUNTRY SUBHILT STAG.** All the same impressive features and specifications as model 02LL316 (above), but with a rugged, genuine stag handle. Includes a sturdy, high quality leather sheath. Blade length: 5⁷/₈". Overall length: 10⁵/₈". Weight: 11.5 oz. Item No. 02LL315 \$ 103.95

1 **MAGNUM SKINNER.** Finally, a skinner that is perfect for hunting as well! The handle scales are made of polished black Micarta, secured with mosaic pins, and featuring stainless steel bolsters. The high-gloss polished, hollow ground blade is made of 440 stainless steel, and has a thickness of over 5mm, offering excellent cutting performance. Includes leather sheath. Blade length: 3⁵/₈". Overall length: 7⁷/₈". Weight: 6.4 oz. Item No. 02SC201 \$ 44.95

2 **MAGNUM HUNTER'S HOOK.** This multi-purpose hunting and skinning knife can handle anything! Features a curved skinner blade and gut hook, partially serrated, crafted of high performance 440 stainless steel. The handsome rosewood handle completes the look. Includes leather sheath. Blade length: 3¹/₂". Overall length: 7⁷/₈". Weight: 4.6 oz. Item No. 02MB132 \$ 35.95

3 **MAGNUM BACK COUNTRY SUBHILT MICARTA.** A Subhilt knife has always been something special - and

usually falls into the three or four digit price range. The engineering is extremely difficult and costly. The main characteristic is the second handguard, between the index and middle finger, which makes slipping of the handle impossible. The The 440 stainless steel blade boasts a fine satin finish, and is ideal for nearly any outdoor activity. The black Micarta handle melts into your hand, and provides a firm and secure grip. The checkering on the spine offers additional traction for powerful and controlled cuts. Includes a sturdy, high quality leather sheath. Blade length: 5⁷/₈". Overall length: 10⁵/₈". Weight: 11.5 oz. Item No. 02LL316 \$ 70.95

5 **MAGNUM SAFARI MATE.** A powerful fixed blade knife with a 6" long Bowie blade made of 440 stainless steel. The grooved handle features attractive laminated wood, and the guard and pommel are made of satin finished stainless steel. Includes brown leather sheath with front pocket and sharpening stone. Overall length: 11". Weight: 8.8 oz. Item No. 02MB207 \$ 46.95

5
Magnum
Safari Mate.
\$ 46.95

6
Magnum
Outback Field.
\$ 54.95

7
Magnum
Duck Hunter.
\$ 92.95

8
Magnum
Premium
Bowie.
\$ 41.95

6 MAGNUM OUTBACK FIELD. With a traditional leather handle and deep blood grooves. Blade length: 6 $\frac{1}{3}$ ". Overall length: 10 $\frac{7}{8}$ ". Weight: 8.7 oz. Item No. 02MB704 \$ 54.95

7 MAGNUM DUCK HUNTER. An optimal candidate for extended trekking and survival trips. The massive 440 stainless steel blade is finely polished and extremely sturdy, with its 5.8mm thickness. The shape of the blade is based on the historical Bowie knife, and gives it unparalleled character. The black ply wood handle is topped off by a heavy brass knob in the form of

a stylized duck head. Includes leather sheath. Blade length: 9 $\frac{1}{8}$ ". Overall length: 14 $\frac{3}{4}$ ". Weight: 21.1 oz. Item No. 02MB399 \$ 92.95

8 MAGNUM PREMIUM BOWIE. The satin finished blade is hollow ground for superior cutting performance, and the

handle is made with a brass guard and pommel, stacked leather washers and ebony wood. Includes leather sheath. Blade length: 6". Overall length: 11". Weight: 8.4 oz. Item No. 02GL684 \$ 41.95

M MAGNUM
by **BOKER**

Straight to the point.

1
Magnum Elk Skinner.
\$ 37.95



2
Magnum Youth Elk Hunter.
\$ 34.95



3
Magnum Elk Hunter.
\$ 35.95



NEW

4
Magnum Southwest.
\$ 103.95



NEW

5
Magnum Premium Skinner.
\$ 46.95



1 MAGNUM ELK SKINNER. Another addition to the popular Elk Hunter series. This compact and stout fixed blade will handle everything on the big game hunt. The full tang construction, with a 440 stainless steel blade, makes it a rugged and reliable hunting and outdoor companion. The handle is crafted of rosewood and walnut. Includes leather sheath. Blade length: 3¼". Overall length: 7½". Weight: 3.7 oz. Item No. 02RY688 \$ 37.95

2 MAGNUM YOUTH ELK HUNTER. This fixed blade youth knife is patterned after the successful Elk Hunter (model 02GL683). The construction of the two models is identical, but the youth knife is much

smaller and is designed for little hands and for safety, with its dull, unsharpened tip. The blade is made of 440 stainless steel, and the handle is crafted of rosewood and walnut. Includes leather sheath. Blade length: 3¼". Overall length: 6¼". Weight: 2.2 oz. Item No. 02MB362 \$ 34.95

3 MAGNUM ELK HUNTER. A functional and stylish hunting knife with a 440 stainless steel blade and rosewood/root wood combination handle. Includes a dark brown leather sheath. Blade length: 4½". Overall length: 8⅝". Weight: 5.5 oz. Item No. 02GL683 \$ 35.95

4 MAGNUM SOUTHWEST. An impressive full tang knife, sure to satisfy not only the collector, with its charismatic grind lines and comfortably rounded Micarta handle, but also serves as a heavy duty work knife that can handle any task. The tremendous thickness and strength of the steel makes it capable of hardcore use. The decorative file work on the spine not only adds an elegant touch, but also provides traction when putting pressure on the back of the blade. The satin finished blade is made of high performance AUS-8 steel. Includes a high quality Cordura sheath. Blade length: 3¾". Overall length: 8¼". Weight: 5.2 oz. Item No. 02YA001 \$ 103.95

5 MAGNUM PREMIUM SKINNER. The finely polished 440 stainless steel blade is dominated by its typically upswept skinner point. The rounded cutting edge makes hunting and skinning very easy. The handle, with its large handguard, offers outstanding protection from slipping onto the blade, and is constructed of jigged bone and Pakka wood, separated by a thin brass liner. Includes a high quality leather sheath with snap closure. Blade length: 4¾". Overall length: 9⅝". Weight: 6.3 oz. Item No. 02LL163 \$ 46.95

6 MAGNUM UNDERDOG. This dagger is both lightweight and highly effective. Black coated 440 stainless steel blade and a polymer handle with integrated guard, which provides a safe and sure grip. Includes nylon sheath. Blade length: 6⅝". Overall length: 11¾". Weight: 6.5 oz. Item No. 02RY6505 \$ 31.95

6
Magnum
Underdog.
\$ 31.95



7
Magnum
Bowie FB.
\$ 57.95



8
Magnum
Duck Head
Bowie.
\$ 51.95



9
Magnum
Scout.
\$ 51.95



10
Magnum
Giant Bowie.
\$ 56.95



7 MAGNUM BOWIE FB. This classic design goes way back in the history of functional fixed blades. The polished 440 stainless steel clip point blade can handle a wide variety of cutting chores. The black wood handle provides a firm and secure grip with its deep finger grooves. Even working with the edge upwards, this handle shows outstanding ergonomics. Includes a black leather sheath with a sharpening stone in the front pocket. Blade length: 5⁷/₈". Overall length: 10³/₄". Weight: 8.9 oz. Item No. 02MB027 \$ 57.95

8 MAGNUM DUCK HEAD BOWIE. Unique outdoor Bowie knife, featuring a brass duck head pommel. The handle is made of pressed leather rings with

black and white fiber layers, and the blade is high performance 440 stainless steel. Includes a leather sheath with a small grinding stone. Blade length: 6". Overall length: 11". Weight: 8.3 oz. Item No. 02MB598 \$ 51.95

9 MAGNUM SCOUT. A true path finder. The large blade of 440 stainless steel has a rustic hammer look, giving the Scout a very unique charm. The lightweight aluminum handguard and pommel provide the required balance and protect the hand when carrying out heavy duty chores. The handle is made of finely grained Pakka wood. Includes a black leather sheath with press stud fastener. Blade length: 7". Overall length: 11⁷/₈". Weight: 7.4 oz. Item No. 02MB018 \$ 51.95

10 MAGNUM GIANT BOWIE. A new interpretation of the legendary Vietnam style Bowie, with impressive dimensions. The 440 stainless steel blade features a precise grinding and is extremely sharp. The guard and pommel are made of polished stainless steel, and the genuine leather handle features soft finger grooves, which tops off the overall look of this classic piece. Overall length: 12⁵/₈". Blade length: 8¹/₈". Weight: 11.6 oz. Item No. 02MB565 \$ 56.95

MAGNUM BY BOKER



1 MAGNUM MACRO STUBBY. This knife boasts an elegant look while providing reliability and function. The wide blade, with a fine satin finish, is made of 440 stainless steel and is rock solid with its full tang construction and a thickness of $\frac{5}{32}$ ". The bellied drop point blade is hollow ground for optimal cutting efficiency. The brushed handguard and selected burl wood scales make this an exquisite piece! Comes complete with lanyard hole and leather sheath. Blade length: $4\frac{1}{4}$ ". Overall length: $8\frac{7}{8}$ ". Weight: 6.9 oz. Item No. 02RY6197 \$ 35.95

1
Magnum
Macro Stubby.
\$ 35.95



2 MAGNUM DELUXE HUNTER. This unique fixed blade is not only stylish, but also highly functional. Featuring a slim silhouette and satin finished, hollow ground blade made of 440 stainless steel, which flows seamlessly to the intricately decorated Micarta handle. This knife is sure to make a good impression! Includes leather sheath. Blade length: $3\frac{3}{4}$ ". Overall length: $8\frac{3}{8}$ ". Weight: 5.6 oz. Item No. 02SC011 \$ 46.95

2
Magnum
Deluxe Hunter.
\$ 46.95



3 MAGNUM HIGHLANDS RANGER. This modern heavy duty fixed blade is made for the user who needs a sturdy and reliable knife for work or leisure. The full tang construction provides maximum stability, and the 440 stainless steel blade delivers superior sharpness and edge retention. The handle scales are made of milled Micarta slabs, which are contoured for outstanding ergonomics. Includes lanyard hole and Kydex sheath. Blade length: $4\frac{3}{4}$ ". Overall length: $9\frac{3}{4}$ ". Weight: 7.6 oz. Item No. 02MB522 \$ 46.95

3
Magnum
Highlands Ranger.
\$ 46.95



4 MAGNUM CAMO BOWIE. The outdoor version of the legendary Vietnam style Bowie. The typical Bowie shape of the 440 stainless steel blade, large handguard, and deep finger grooves are reminiscent of its origin. The stainless steel handguard and end cap, along with the detailed camo pattern make this a truly remarkable piece. Comes complete with a matching camo sheath. Blade length: 6". Overall length: $10\frac{3}{4}$ ". Weight: 9 oz. Item No. 02MB208 \$ 46.95

4
Magnum
Camo Bowie.
\$ 46.95



5
Magnum
Midnight
Bowie.
\$ 46.95



5 MAGNUM MIDNIGHT BOWIE. A tactical interpretation of the legendary Vietnam Bowie. The characteristic blade shape, wide double handguard, and deep finger grooves are reminiscent of the original. Features a black coated 440 stainless steel blade, and comes complete with a matching black leather sheath. Blade thickness: $\frac{3}{16}$ ". Blade length: 6". Overall length: 10 $\frac{3}{4}$ ". Weight: 9 oz. Item No. 02MB209 \$ 46.95

MAGNUM NORDIC SERIES. With this new series of functional and weather resistant knives, you are perfectly equipped for your next outdoor adventure. The blades are made of 440 stainless steel and are finely polished. The rugged black rubber handles provide a comfortable and secure grip, even in adverse weather conditions. Each model comes complete with a high quality synthetic sheath that matches the handle. Includes water drainage hole and multifunction clip. Magnum Nordic - the ideal companion, for an incredible price! Blade length: 4 $\frac{1}{2}$ ". Overall length: 9". Weight: 3.7 oz. Available in three versions:

6 MAGNUM NORDIC BLACK. With black sheath and handle accents. Item No. 02RS001 \$ 20.95

7 MAGNUM NORDIC OLIVE. With olive sheath and handle accents. Item No. 02RS003 \$ 20.95

8 MAGNUM NORDIC ORANGE. With orange sheath and handle accents. Item No. 02RS002 \$ 20.95

9 MAGNUM DEER HUNTER. Affordable fixed blade functionality. This workhorse of a fixed blade knife has a 4" drop point stainless steel blade. The finger grooves in the textured rubber handle provide for a super-secure grip. Includes lanyard hole and Cordura sheath. Overall length: 8 $\frac{3}{8}$ ". Weight: 4.4 oz. Item No. 02MB146 \$ 15.95

10 MAGNUM DEER HUNTER II. Same specs as 02MB146 (above), but with a blaze orange handle. Item No. 02MB1460 \$ 15.95

11 MAGNUM FILLET LARGE. This handy fillet knife features an anti-slip injected Kraton handle for maximum grip, and an especially flexible blade, made of 440 stainless steel. Includes a sturdy synthetic sheath with belt clip and drainage holes.. Blade length: 7 $\frac{1}{2}$ ". Overall length: 14". Weight: 3.9 oz. Item No. 02MB019 \$ 20.95

6
Magnum
Nordic Black.
\$ 20.95

7
Magnum
Nordic Olive.
\$ 20.95

8
Magnum
Nordic Orange.
\$ 20.95

9
Magnum
Deer Hunter.
\$ 15.95

10
Magnum Deer
Hunter II.
\$ 15.95

11
Magnum
Fillet Large.
\$ 20.95



MAGNUM BY BOKER

Authentic Damascus with Magnum Pricing.

1
Magnum
Lord.
\$ 90.95

2
Magnum
Senior.
\$ 70.95

3
Magnum
King.
\$ 59.95

4
Magnum
Rosewood
Damascus.
\$ 82.95

With this exclusive high class knife series, we bring you an extraordinary collection of Damascus and exotic woods. This series features knives with genuine forged Damascus blades with 37 layers. No etching or fake patterns – this is the real deal! Charm, character and quality at a very reasonable price.

1 MAGNUM LORD. Classic double bolster knife with dress plates made of polished stainless steel. Carefully selected twill wood is used for the handle, which gives the knife its high

class look. Back lock mechanism. Does not have pocket clip. Overall length: 8½". Blade length: 3⅝". Weight: 4.6 oz. Item No. 01MB790DAM \$ 90.95

2 MAGNUM SENIOR. This slim liner locking folder is ideal for everyday use, with its pocket clip and one-handed opening. Features attractive twill wood handle scales, for the demanding knife aficionado. Overall length: 7⅞". Blade length: 3". Weight: 2.8 oz. Item No. 01MB030DAM \$ 70.95

3 MAGNUM KING. This elegant piece features a large polished stainless steel bolster and burl wood scales, neatly riveted on the handle. Includes lanyard hole to prevent loss of this piece of jewelry. Back locking mechanism. Does not include pocket clip. Overall length: 7". Blade length: 3". Weight: 3.1 oz. Item No. 01MB559DAM \$ 59.95

4 MAGNUM ROSEWOOD DAMASCUS. This classic Damascus pocket knife features handsome rosewood handle scales, stainless steel bolsters, nail nick and sturdy lockback mechanism. The blade is crafted of

37-layer Damascus steel. A work of art! Blade length: 3". Overall length: 7". Weight: 3.7 oz. Item No. 01RY166DAM \$ 82.95

5 MAGNUM DAMASCUS QUINCEWOOD. A breathtaking piece, featuring elegant Quincewood handles with Damascus bolsters and blade. Sturdy backlock mechanism. Classic beauty at its best! Overall length: 5⅞". Blade length: 2½". Weight: 2.5 oz. Item No. 01MB550DAM \$ 72.95

6 MAGNUM BLACK BONE DAMASCUS. Similar to item 01MB550DAM (above), but with handsome black bone handles. Overall length: 5⅞". Blade length: 2½". Weight: 3.2 oz. Item No. 01MB551DAM \$ 88.95

5
Magnum
Damascus
Quincewood.
\$ 72.95

6
Magnum
Black Bone
Damascus.
\$ 88.95

8
Magnum
Lady.
\$ 46.95

7
Magnum
Damascus
Bone.
\$ 92.95

9
Magnum
Duke.
\$ 56.95

10
Magnum
Empress.
\$ 90.95

11
Magnum
Noblesse.
\$ 67.95

7 MAGNUM DAMASCUS BONE. A truly stunning pocket knife, featuring a finely drawn Damascus blade and Damascus bolsters. The handle scales are crafted of polished bone, giving a beautiful contrast to the darker Damascus steel. Sturdy backlock mechanism. Overall length: 7". Blade length: 3 1/8". Weight: 3.6 oz. Item No. 01MB180DAM \$ 92.95

8 MAGNUM LADY. Similar to the Lord model, but in a smaller size. Features a sturdy back lock mechanism, burl wood scales and a breathtaking Damascus blade with 37 layers. A real beauty! Overall length: 5 1/2". Blade length: 2 3/8". Weight: 2.4 oz. Item No. 01MB788DAM \$ 46.95

9 MAGNUM DUKE. This exquisite knife is sure to impress! The bolsters feature a decorative etch, providing the perfect contrast to the hand selected burl wood scales, which guarantee a comfortable feel in your hand. Despite the elegance of this piece, it is a reliable and hard working knife - with its back lock mechanism and lanyard hole, it is sure to prove itself as your everyday companion. Blade length: 2 1/2". Overall length: 5 3/4". Weight: 2.3 oz. Item No. 01MB946DAM \$ 56.95

10 MAGNUM EMPRESS. This is the premium grade version of the popular "Lady" model (item 01MB788DAM). This piece not only has a blade made of an impressive 49 layers of forged

steel, it also features four bolsters made of forged Damascus as well. The root wood handle makes it even more exclusive, and it just feels good in your hand. Sturdy lockback mechanism. Blade length: 2 3/8". Overall length: 5 1/2". Weight: 2.3 oz. Item No. 01MB789DAM \$ 90.95

11 MAGNUM NOBLESSE. This distinctive fixed blade is perfect for the person who wants to work with style. A damascus blade with 49 layers of steel, brass handguard and hand selected wood handles makes this a truly eye-catching piece. Strong enough to carve wood, and perform heavy duty chores with class. Includes leather sheath and lanyard hole. Blade length: 3 3/8". Overall length: 7". Weight: 2.4 oz. Item No. 02MB051 \$ 67.95

Blade spectrum.



1
Magnum
Rainbow II.
\$ 23.95



2
Magnum
Rainbow IV.
\$ 22.95



3
Magnum
Rainbow V.
\$ 29.95

1 MAGNUM RAINBOW II. This model really stands out with its wild array of colors. The liner locking blade of edge-holding 440 stainless steel is partially serrated and hollow ground. The handle is titanium PVD coated stainless steel and includes a pocket clip. Blade length: 2⁷/₈". Overall length: 6³/₄". Weight: 3.1 oz. Item No. 01YA107 \$ 23.95

2 MAGNUM RAINBOW IV. The success of the popular Magnum Rainbow Series continues. This youngest member of the series features a slim profile, while being heavyweight and sturdy. The 440 stainless steel

blade and steel handle boast a stunning array of colors. Pocket clip and lanyard hole. Blade length: 2⁷/₈". Overall length: 6¹/₂". Weight: 2.4 oz. Item No. 01SC615 \$ 22.95

3 MAGNUM RAINBOW V. Our popular Rainbow Series expands! This new model is sure to impress, with its anodized stainless steel handle scales in skeleton form. The ergonomic shape allows a comfortable and

secure grip. The 440 stainless steel blade is secured with a sturdy frame lock mechanism. Includes pocket clip for easy carry. Blade length: 3³/₈". Overall length: 7⁷/₈". Weight: 3.8 oz. Item No. 01MB627 \$ 29.95

4 MAGNUM BLAZE. A real eye catcher! This attractive piece shows off an array of colors on the handle and the 440 stainless steel blade, created by a complex treatment process. The 2⁷/₈" blade is held open by a frame

lock mechanism. Includes pocket clip and lanyard hole. Overall length: 6³/₄". Weight: 2.9 oz. Item No. 01MB255 \$ 24.95

5 MAGNUM RAINBOW III. A new pocket knife for the Rainbow Series! This lightweight knife weighs only 1.7 oz., and features blade cutouts for easy one-hand opening. The pocket clip, 440 stainless steel blade and handle are anodized in rainbow colors. The frame lock ensures locking security. Blade length: 2⁵/₈". Overall length: 6¹/₈". Item No. 01SC423 \$ 24.95

6 MAGNUM BONDSMAN RAINBOW. An attractive companion for work or leisure. Solid construction with a combination of two stainless steel plates and lightweight aluminum scales. The 440 stainless steel blade,



4
Magnum
Blaze.
\$ 24.95



5
Magnum
Rainbow III.
\$ 24.95



6
Magnum
Bondsman
Rainbow.
\$ 24.95



7
Magnum Dark
Rainbow.
\$ 30.95



8
Magnum
Rainbow I.
\$ 20.95



NEW

9
Magnum
Slim
Rainbow.
\$ 19.95

bolsters and liners feature a special rainbow colored anodizing. One-hand opening and liner locking. Blade length: 3½". Overall length: 8". Weight: 4.2 oz. Item No. 01SC943 \$ 24.95

7 MAGNUM DARK RAINBOW. This minimalistic piece is not only attractive to look at, but also highly functional. The black coated 440 stainless steel blade is secured by the back lock, which can also be used to detach the lanyard. The sleek handle is made of iridescent liners with black stainless steel scales. The slim, flat profile of this knife allows comfortable pocket carry, and the lanyard gives easy access. Blade length: 2⅝". Overall length: 6¼". Weight: 2.8 oz. Item No. 01SC014 \$ 30.95



10
Magnum Full
Metal Pocket.
\$ 25.95

8 MAGNUM RAINBOW I. The smaller version in the Rainbow Series, featuring a titanium PVD coated handle, hollow ground 440 stainless steel blade and carabiner hook. Frame locking system. Blade length: 2¾". Overall length: 5⅜". Weight: 1.8 oz. Item No. 01YA106 \$ 20.95

9 MAGNUM SLIM RAINBOW. An extremely flat knife, with a handle thickness of just 5.8mm, making itself nearly invisible and weightless in your pocket. The 440 stainless steel blade has a sturdy lockback mechanism, and the edges of the handle feature all the colors of the rainbow for added appeal. Blade length: 1⅞". Overall length: 4½". Weight: 1.7 oz. Item No. 01MB120 \$ 19.95



NEW

11
Magnum
Steel Flash.
\$ 19.95

10 MAGNUM FULL METAL POCKET. Price and performance! This sturdy folder features polished stainless steel handle scales for an ultra sleek look. The liner locking 440 stainless steel blade is satin finished, and features a removable thumb disc. Also features a lanyard hole and removable pocket clip (tip-down carry). Blade length: 3½". Overall length: 8". Weight: 5.1 oz. Item No. 01MB110 \$ 25.95

11 MAGNUM STEEL FLASH. This sleek and attractive knife features a polished 440 stainless steel blade and sturdy liner lock mechanism. The stainless steel handle boasts a fine satin finish, and has polished edges for added elegance. Includes pocket clip. Blade length: 3". Overall length: 7¼". Weight: 4.8 oz. Item No. 01RY461 \$ 19.95

12 MAGNUM ARCS I. This elegant pocket knife features handsome dark wooden scales and blue plates and screws. The titanium coated blade, made of 440 stainless steel, completes the noble appearance. Sturdy liner locking mechanism. Does not have pocket clip. Blade length: 3⅞". Overall length: 7⅞". Weight: 2.7 oz. Item No. 01RY917 \$ 28.95

12
Magnum
Arcs I.
\$ 28.95

MAGNUM BY BOKER



Tools of the trade.



1
Magnum Air Force Rescue.
\$ 27.95

2
Magnum Fire Fighter.
\$ 27.95

3
Magnum EMS Rescue.
\$ 27.95

4
Magnum Army Rescue.
\$ 27.95

This series of highly functional rescue knives is dedicated to police, paramedic and rescue professionals, who do their best in their dangerous fulfillment of duty and often risk it all to save lives. These knives are equipped with all the necessities – glass breaker, belt cutter, carry clip, and corrosion resistant 440 stainless steel blades. Available in eleven versions:

1 MAGNUM AIR FORCE RESCUE. Black coated, partially serrated, reverse tanto blade with flipper, and royal blue anodized aluminum handle with U.S. Air Force crest. Blade length: 3³/₈". Overall length: 8¹/₈". Weight: 4.9 oz. Item No. 01LL473 \$ 27.95

2 MAGNUM FIRE FIGHTER. Black coated, partially serrated, reverse tanto blade with flipper, and red anodized aluminum handle with firefighter crest. Blade length: 3³/₈". Overall length: 8¹/₈". Weight: 4.9 oz. Item No. 01LL470 \$ 27.95

3 MAGNUM EMS RESCUE. Black coated, partially serrated, reverse tanto blade with flipper, and orange anodized aluminum handle with EMS crest. Blade length: 3³/₈". Overall length: 8¹/₈". Weight: 4.9 oz. Item No. 01LL472 \$ 27.95

4 MAGNUM ARMY RESCUE. Black coated, partially serrated, reverse tanto blade with flipper, and olive anodized aluminum handle with U.S. Army crest. Blade length: 3³/₈". Overall length: 8¹/₈". Weight: 4.9 oz. Item No. 01LL471 \$ 27.95

5 MAGNUM FIRE DEPARTMENT. The only knife in this series with a high-grip G-10 scale. Red handle with firefighter logo inlay. Blade length: 3³/₈". Overall length: 8¹/₈". Weight: 4.8 oz. Item No. 01MB366 \$ 24.95

6 MAGNUM MEDIC. Orange anodized aluminum handle with blue and white paramedic logo. Blade length: 3³/₈". Overall length: 8¹/₈". Weight: 4.3 oz. Item No. 01MB364 \$ 24.95

7 MAGNUM LAW ENFORCEMENT. Blue anodized aluminum handle with black and gold police logo. Blade length: 3³/₈". Overall length: 8¹/₈". Weight: 4.3 oz. Item No. 01MB365 \$ 24.95

8 MAGNUM SPECIAL FORCES. This tactical rescue knife can handle anything. Features a black coated blade made of 440 stainless steel, which can be opened quickly with one hand, and the sturdy liner lock prevents accidental collapse in an emergency. The glass-breaker and belt cutter complete this useful tool. Blade length: 3³/₈". Overall length: 8¹/₈". Weight: 4.1 oz. Item No. 01SC154 \$ 24.95

9 MAGNUM SPECIAL FORCES BK. This highly functional knife is dedicated to the Special Forces. The black coated aluminum handle features the crest of this special unit, and the black coated 440 stainless steel blade locks securely with the liner lock. Also features a seatbelt cutter and glass-breaker for emergency use. Blade length: 3³/₈". Overall length: 7³/₄". Weight: 4 oz. Item No. 01MB856 \$ 24.95

10 MAGNUM FIRE ANT. This small and handy rescue knife should be kept inside every vehicle. The sturdy black handle features a liner locking mechanism and pocket clip for convenient carry. Also features a black coated 440 stainless steel blade, seatbelt cutter and glass-breaker. Blade length: 2³/₈". Overall length: 6¹/₈". Weight: 2.8 oz. Item No. 01RY409 \$ 24.95

11 MAGNUM MIDNIGHT RESCUE. The larger version of model 01RY409 (above). Same great features as the smaller model, but with added dimensions for heavy duty missions. Includes pocket clip, seatbelt cutter and glass-breaker. Blade length: 3³/₈". Overall length: 8⁷/₈". Weight: 4.7 oz. Item No. 01RY414 \$ 27.95

5
Magnum Fire
Department.
\$ 24.95



6
Magnum
Medic.
\$ 24.95



7
Magnum Law
Enforcement.
\$ 24.95



8
Magnum
Special Forces.
\$ 24.95



9
Magnum Special
Forces BK.
\$ 24.95



10
Magnum
Fire Ant.
\$ 24.95



11
Magnum
Midnight Rescue.
\$ 27.95



MAGNUM BY BOKER

M MAGNUM
by BOKER

Rock Solid.

1
Magnum
Fishbone.
\$ 24.95



2
Magnum
Waves.
\$ 24.95



3
Magnum
Snowflake.
\$ 20.95



1 MAGNUM FISHBONE. A strong and durable knife, for work and leisure. The titanium coated 440 stainless steel blade can be opened and closed with one hand, and locked securely with the liner lock. The anodized aluminum handle millings provide a positive grip in the hand. Pocket clip for easy carry. Blade length: 3¾". Overall length: 8½". Weight: 5.8 oz. Item No. 01MB009 \$ 24.95

2 MAGNUM WAVES. A strong and durable knife, for work and leisure. The wave-shaped grip, made of aluminum, and the titanium coated 440 stainless steel blade make this knife a reliable companion. Liner lock mechanism and pocket clip. Blade length: 3¾". Overall length: 8½". Weight: 5.6 oz. Item No. 01MB100 \$ 24.95

3 MAGNUM SNOWFLAKE. Attractive folding knife with a high tech appearance. The 440 stainless steel blade features a unique faux Damascus pattern and gray anodized aluminum handles. Blade length: 3". Overall length: 7½". Weight: 4 oz. Item No. 01GL0623 \$ 20.95

4 MAGNUM BKT. This heavy duty folder features a black coated, partially serrated tanto-style blade of 420 stainless steel, and lightweight aluminum handle with push button lock (non-automatic). Includes pocket clip. Blade length: 3¼". Overall length: 8". Weight: 4.4 oz. Item No. 01B0018 \$ 41.95

5 MAGNUM T. This heavy duty folder features a bead-blasted, plain edge tanto-style blade of 420 stainless steel, and lightweight aluminum handle with push button lock (non-automatic). Includes pocket clip. Blade length: 3¼". Overall length: 8". Weight: 4.4 oz. Item No. 01B0008 \$ 41.95



4
Magnum BKT.
\$ 41.95



5
Magnum T.
\$ 41.95



6
Magnum T.
\$ 41.95

7
Magnum
Rocket.
\$ 24.95

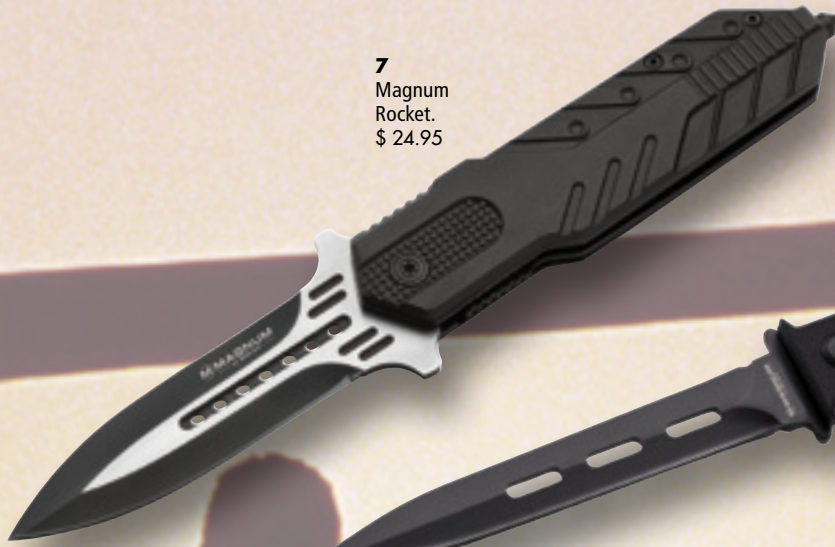

8
Magnum
Slots.
\$ 24.95



9
Magnum
Special Agent.
\$ 24.95



10
Magnum
Black Spear.
\$ 22.95



11
Magnum
Stout.
\$ 24.95



6 MAGNUM T. This heavy duty folder features a bead-blasted, plain edge blade of 420 stainless steel, and lightweight aluminum handle with push button lock (non-automatic). Blade length: 3¼". Overall length: 8". Weight: 4.4 oz.
Item No. 01B0007 \$ 41.95

7 MAGNUM ROCKET. This unique tactical piece boasts a strikingly milled two-tone finish on the 440 stainless steel blade. The flipper provides for hand protection, and the aluminum scales house a steel liner, for the sturdy liner lock mechanism. Also features a glass breaker and pocket clip. Blade length: 3½". Overall length: 8¾". Weight: 4.8 oz.
Item No. 01RY596 \$ 24.95

8 MAGNUM SLOTS. This sleek liner locking folder is both slim and sturdy. Features G-10 handle scales for a secure grip, and a black coated 440 stainless steel blade. Includes pocket clip. Blade length: 4". Overall length: 9". Weight: 3.8 oz.
Item No. 01SC084 \$ 24.95

9 MAGNUM SPECIAL AGENT. This all black tactical folder feels like it was designed around your hand. The finger grooves and the ergonomically shaped handle melt together for a comfortable fit. The black aluminum handles have a slip-resistant checkering for added

grip in any environment. The 440 stainless steel blade is black coated and partially serrated for ultimate function. Blade length: 3½". Overall length: 8". Weight: 5.3 oz.
Item No. 01MB830 \$ 24.95

10 MAGNUM BLACK SPEAR. This tactical knife is perfect for any mission. The modified 440 stainless steel spear point blade has a slight recurve shape, and is black coated and partially serrated, ideal for chewing through fibrous materials. The sturdy liner lock prevents accidental closing, and the deep finger grooves

in the black aluminum handle provide ultimate control. Also features a glass-breaker, lanyard hole and pocket clip. Blade length: 3¾". Overall length: 9½". Weight: 8 oz.
Item No. 01RY247 \$ 22.95

11 MAGNUM STOUT. A rock solid knife for any mission. Checkered aluminum inserts for maximum grip and control, and a 3½" blade made of 440 stainless steel. Overall length: 8½". Weight: 7.5 oz.
Item No 01MB408 \$ 24.95





1
Magnum
Shadow.
\$ 19.95



2
Magnum
Persian.
\$ 20.95



3
Magnum
Night Watch.
\$ 22.95



4
Magnum
Starfighter.
\$ 25.95

side, and is crafted of 440 stainless steel. Includes pocket clip. Blade length: 3¾". Overall length: 8¼". Weight: 4 oz. Item No. 01RY069 \$ 25.95

5 MAGNUM HIGH PEAK. The black 440 stainless steel blade, satin finished bolsters and attractive laminated wood handle build the character of this knife. The sturdy aluminum handle scales feature a firm and secure grip. Includes pocket clip. Liner locking mechanism. Does not have pocket clip. Blade length: 3¼". Overall length: 7¾". Weight: 5.4 oz. Item No. 01RY967 \$ 22.95

6 MAGNUM 30-06 BULLET KNIFE. An interesting replica of a 30-06 bullet with a compact and functional blade. A great gift for the hunter or collector. Features a 440 stainless steel blade, brass coated shell, and keyring. Blade length: 1¾". Overall length: 4¾". Weight: 1.4 oz. Item No. 01SC249 \$ 10.95

7 MAGNUM .44 BULLET KNIFE. A functional knife that resembles the .44 Magnum bullet. A great accessory for the sportsman or collector. Features a 440 stainless steel blade with brass coated casing. Blade length: 1⅞". Overall length: 2⅝". Weight: 0.9 oz. Item No. 01SC938 \$ 9.95



5
Magnum
High Peak.
\$ 22.95

1 MAGNUM SHADOW. This sleek black knife is a lightweight companion that will never let you down. The sturdy aluminum handle scales feature apertures for weight reduction, and the black-coated 440 stainless steel blade is secured by a liner locking mechanism. Includes pocket clip and lanyard hole. Blade length: 3¼". Overall length: 7½". Weight: 2.9 oz. Item No. 01MB428 \$ 19.95

2 MAGNUM PERSIAN. This exotic design, with its prominent blade shape, is reminiscent of a typical Persian knife. The black 440 stainless steel blade is secured by a liner lock, and the unique shape of the aluminum handle provides a firm and secure grip. Includes pocket clip. Blade length: 3⅝". Overall length: 7⅝". Weight: 4.3 oz. Item No. 01MB870 \$ 20.95

3 MAGNUM NIGHT WATCH. The perfect companion when compactness is a must. This slim knife features

sturdy aluminum handles mounted on stainless steel liners which house the liner lock. The slender, dagger shaped blade is made of 440 stainless steel and is finely ground. Includes pocket clip. Blade length: 3⅝". Overall length: 7⅝". Weight: 4.7 oz. Item No. 01RY524 \$ 22.95

4 MAGNUM STARFIGHTER. This futuristic looking knife features a spindle shaped handle that will fit securely in the hand, and is representative of historical swords, set off by handsome cocobolo wood. The dagger shaped blade is ground on one

6
Magnum
30-06 Bullet
Knife.
\$ 10.95



7
Magnum .44
Bullet Knife.
\$ 9.95



8
Magnum
Marksman.
\$ 24.95



9
Magnum
Midnight
Star.
\$ 24.95



10
Magnum
Midnight Star
Tanto.
\$ 24.95



11
Magnum
Fire Chief.
\$ 31.95



8 MAGNUM MARKSMAN. This heavy duty liner locking folder features camo scales in the shape of a rifle stock, including an inset for grip enhancement, and the SWAT logo. The olive coated, partially serrated blade is made of high performance 440 stainless steel. Includes pocket clip. Blade length: 3 $\frac{3}{8}$ ". Overall length: 8 $\frac{1}{4}$ ". Weight: 5.1 oz. Item No 01RY580 \$ 24.95

9 MAGNUM MIDNIGHT STAR. This tactical liner locking folding knife features handy finger grooves that lie comfortably and securely in your hand, and a handsome wooden inset. The black coated blade is made of 440 stainless steel. Includes pocket clip. Blade length: 3 $\frac{3}{8}$ ". Overall length: 7 $\frac{7}{8}$ ". Weight: 4.3 oz. Item No 01RY566 \$ 24.95

10 MAGNUM MIDNIGHT STAR TANTO. This liner locking folding knife features a sturdy handle that lies comfortably and securely in your hand. The modified tanto blade is made of 440 stainless steel, black coated, and has a cutout for easy opening. Includes pocket clip. Blade length: 3 $\frac{1}{4}$ ". Overall length: 7 $\frac{3}{4}$ ". Weight: 4.4 oz. Item No 01RY621 \$ 24.95

11 MAGNUM FIRE CHIEF. This massive and impressive rescue knife can handle anything. The striking

color combination of red and black is set off by the gold colored emblem in the handle, honoring the men and women who stand in the fire department. Features a glass breaker, seatbelt cutter and partially serrated 440 stainless steel blade that can take on any emergency situation. Includes pocket clip. Blade length: 4 $\frac{1}{2}$ ". Overall length: 10 $\frac{5}{8}$ ". Weight: 10 oz. Item No. 01LL313 \$ 31.95



The power house.

1
Magnum First
Responder.
\$ 31.95



2
Magnum
Sporting
Knife Titan.
\$ 22.95



3
Magnum Black
Lightning.
\$ 17.95



4
Magnum
Deep Blue.
\$ 22.95



1 MAGNUM FIRST RESPONDER. Be prepared in case of an accident or breakdown, with this ideal emergency tool. Features a seatbelt cutter, glass-breaker and can opener in the synthetic handle with a checkered non-slip grip. 440 stainless steel blade and pocket clip for easy carry. Blade length: 2¾". Overall length: 6⅝". Weight: 3.3 oz. Item No. 01SC157 \$ 31.95

2 MAGNUM SPORTING KNIFE TITAN. The perfect all around camping and sporting knife for everyone. The attractive dark wood handle features a ring for a lanyard or knife chain, and the blades are black coated 440 stainless steel. Features a main and a secondary blade, cap lifter, flathead screwdriver, can opener, awl and corkscrew. All the necessary functions for any adventure! Blade lengths: 2¾" and 1⅝". Overall length: 6⅜". Weight: 4.1 oz. Item No. 01SC516 \$ 22.95

3 MAGNUM BLACK LIGHTNING. This ultra compact folding knife will melt into your hand. The solid handle is a combination of bead blasted stainless steel and black G-10 scales. The 440 stainless steel blade with a matte black finish features a double sided handguard. Includes pocket clip. Blade length: 1⅞". Overall length: 4⅞". Weight: 3.5 oz. Item No. 01SC148 \$ 17.95

4 MAGNUM DEEP BLUE. A real eye-catcher! The 440 stainless steel blade and the liners of this attractive pocket knife are anodized in a particularly intense shade of blue. Framelock mechanism with a handsome rosewood handle. Lanyard hole and pocket clip for easy carry. Blade length: 2⅜". Overall length: 5⅞". Weight: 1.5 oz. Item No. 01SC156 \$ 22.95

5 MAGNUM COMPACT RESCUE. This compact rescue knife shouldn't be under-estimated! The black coated 440 stainless steel blade is partially serrated, and locks securely with the liner lock. The black anodized aluminum handle features a seatbelt cutter and glass-breaker for rescue situations, and a pocket clip for easy carry. Blade length: 2⅜". Overall length: 5½". Weight: 3 oz. Item No. 01MB456 \$ 20.95

6 MAGNUM TACTICAL RESCUE KNIFE. The rust resistant 440 stainless steel blade boasts an eye-catching matte finish, and the stainless steel/G-10 combination handle features a seatbelt

cutter and glassbreaker. Includes pocket clip. Blade length: 3⅜". Overall length: 8¼". Weight: 6.8 oz. Item No. 01RY997 \$ 22.95

7 MAGNUM RESCUE BK. This hefty knife is the perfect choice in emergency situations. The black coated blade is made of 440 stainless steel, and the massive handle is made of sturdy aluminum and features grip-tape insets. The integrated seatbelt cutter and glass-breaker make it a true life saver. Includes pocket clip. Blade length: 3¾". Overall length: 8⅞". Weight: 7.2 oz. Item No. 01LL200 \$ 25.95

8 MAGNUM EASY RIDER. Not only for bikers! This high tech piece was designed with elements of the motorcycle industry in mind. The spine of the handle is adorned with a motorcycle chain, which provides a secure and comfortable grip. The bead blasted blade can be opened with the thumb stud or the flipper, and locks securely with a liner lock. The grey aluminum handle represents the

rear swing arm and two sprockets of the drive chain. The pocket clip keeps it close at hand. Blade length: 3¼". Overall length: 7⅞". Weight: 5 oz. Item No. 01SC529 \$ 20.95

9 MAGNUM GRAY SPEAR. This sturdy and durable knife can handle anything. Equipped with an effective spear point blade, partially serrated and made of titanium coated 440 stainless steel. The elaborately crafted aluminum scales are also titanium coated and equipped with comfortable grip-milled grooves. Liner locking mechanism and pocket clip. Blade length: 3⅞". Overall length: 8". Weight: 3.6 oz. Item No. 01MB745 \$ 22.95

10 MAGNUM HEAVY METAL. The handle design and selection of materials used make this a real eye catcher. The polished stainless steel handle is highlighted with an attractive aluminum scale. Features an "Iron Cross" cutout and a rustproof blade made of 440 stainless steel. Liner locking mechanism. Includes pocket clip. Blade length: 3¼". Overall length: 7⅞". Weight: 5.6 oz. Item No. 01RY920 \$ 20.95

5
Magnum
Compact Rescue.
\$ 20.95



6
Magnum Tactical
Rescue Knife.
\$ 22.95



7
Magnum
Rescue BK.
\$ 25.95



8
Magnum
Easy Rider.
\$ 20.95



9
Magnum
Gray Spear.
\$ 22.95



10
Magnum
Heavy Metal.
\$ 20.95



MAGNUM BY BOKER

1
Magnum
Stiletto.
\$ 20.95



2
Magnum
Sleekster.
\$ 31.95



3
Magnum
Little Italy.
\$ 25.95



4
Magnum Italian
Classic.
\$ 25.95



5
Magnum Duo
Satin.
\$ 24.95



6
Magnum
Outdoor
Cuisine III.
\$ 22.95



7
Magnum
Outdoor
Cuisine IV.
\$ 22.95



1 MAGNUM STILETTO. A liner locking folding knife with a stiletto design. 3 1/3" blade made of 440 stainless steel with a double handguard. Stainless steel liners strengthen the construction. Laminated wood handles with pocket clip. Overall length: 7 3/8". Weight: 3.7 oz. Item No. 01YA101 \$ 20.95

2 MAGNUM SLEEKSTER. This slender knife speaks for itself with its sleek design. The handsome cocobolo wood handle scales feature milled slots for a secure grip. The 440 stainless steel blade is secured with a liner lock. Includes leather lanyard. Blade length: 3 1/2". Overall length: 8 1/8". Weight: 4 oz. Item No. 01SC750 \$ 31.95

3 MAGNUM LITTLE ITALY. True Italian style. This small blade, made of 440C stainless steel, is securely held in the open position with the lockback mechanism. The handle is crafted of dark, finely grained wood. The ideal companion for everyday cutting chores. Blade length: 3". Overall length: 6 3/4". Weight: 2 oz. Item No. 01LG025 \$ 25.95

4 MAGNUM ITALIAN CLASSIC. This handsome knife is reminiscent of the classic Italian inspired stiletto. A robust and modern interpretation, combining the advantages of modern manufacturing with the classic design. The 440 stainless steel blade locks with the sturdy liner lock mechanism, and the massive, finely polished stainless steel fittings give the knife its superior strength. The handsome rosewood scales provide traditional character, and the pocket clip keeps it close at hand. Blade length: 3 3/4". Overall length: 8 5/8". Weight: 5.3 oz. Item No. 01LL310 \$ 25.95

5 MAGNUM DUO SATIN. This elegant piece boasts a no frills stainless steel handle, in a sleek, linear design. The blade is brushed 440 stainless steel, with a handy thumb stud. Plain and simple - the perfect everyday companion. Includes pocket clip for easy carry. Blade length: 3 7/8". Overall length: 8 1/2". Weight: 4.8 oz. Item No. 01RY465 \$ 24.95

6 MAGNUM OUTDOOR CUISINE III. This large folding knife is perfect for a snack on the road or for camping with friends. An effective kitchen knife for the great outdoors! The handle is crafted of handsome rosewood, and the Japanese Nakiri style blade, made of 440 stainless steel, locks securely with a liner locking mechanism. Blade length: 4 3/4". Overall length: 10 1/4". Weight: 6 oz. Item No. 01MB432 \$ 22.95

7 MAGNUM OUTDOOR CUISINE IV. This impressive outdoor folding Santoku style blade will effectively carve the largest cuts at the campsite! The ergonomic rosewood handle provides comfort for long chores. The blade is 440 stainless steel, and locks securely with the liner locking mechanism. Blade length: 4 3/8". Overall length: 9 3/4". Weight: 7.4 oz. Item No. 01MB457 \$ 22.95

1
Magnum
Ziel 3-pc
Set.
\$ 103.95



2
Magnum
Beil Ax.
\$ 51.95



4
Magnum
Mini Bo-Kri.
\$ 25.95



5
Magnum Throwing
Knife Set.
\$ 56.95

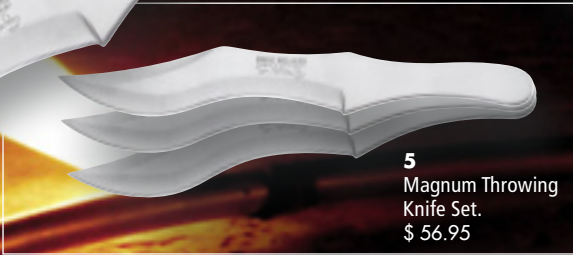

3
Magnum Bailey
Ziel Knife.
\$ 39.95



6
Magnum
Bailey M-Ziel.
\$ 34.95



7
Magnum Throwing
Knife Set Profi I.
\$ 51.95

and tactical personnel. John designed this knife to hold up when you need to pry open a suspicious grate, punch holes in a drum, or pop a car window in a rescue situation - all this in an impressive throwing knife, balanced for fast handle style throwing. Crafted of 420 stainless steel. The leather sheath has a high-rise belt clip and four eyelets, to allow the user to tie down to a vest or other equipment. Thickness: 3/16". Overall length: 8 7/8". Weight: 7 oz.
Item No. 02MB165 \$ 34.95

1 **MAGNUM ZIEL 3-PC SET.** Set of 3 Bailey Ziel knives in a convenient 3-compartment leather belt sheath. Item No. 02MB164 \$ 103.95

2 **MAGNUM BEIL AX.** A John Bailey designed throwing ax featuring 420J2 stainless steel and a user-friendly design that will provide a successful stick even for the beginner. Overall length of 12". A substantial thrower at 1/4" thickness and over one pound. Cordura sheath included. Item No. 02MB161 \$ 51.95

3 **MAGNUM BAILEY ZIEL KNIFE.** This is the throwing knife that all professional and tournament throwers have been asking for. John Bailey's Ziel throwing knife is perfectly balanced for both handle and blade throwing, delivering maximum penetration in all types of competition targets. This is the best "tournament grade" production throwing knife made in decades. The Ziel knife is made of super tough 1/4"

thick 420J2 stainless steel and has an overall length of 13 1/4" and weight of 14 oz., which meets or exceeds all the requirements of most knife throwing clubs. The Ziel knife comes with a genuine leather sheath with tie. Item No. 02MB163 \$ 39.95

4 **MAGNUM MINI BO-KRI.** The latest in design by famed thrower John Bailey. The unique lines and style of this 10 3/4", 420J2 stainless steel thrower offer perfect balance. Comes complete with leather sheath and legstraps. Item No. 02MB160 \$ 25.95

5 **MAGNUM THROWING KNIFE SET.** Set of three 02MB160 Mini BO-KRI throwing knives in a convenient 3-compartment leather belt sheath. A must for the serious knife thrower! Item No. 02MB162 \$ 56.95

6 **MAGNUM BAILEY M-ZIEL.** The M-Ziel boot/throwing knife is not only a compact version of the Ziel by John Bailey, but also an ideal knife for armed forces

7 **MAGNUM THROWING KNIFE SET PROFI I.** This new throwing knife set is robust and reliable! The full steel construction of 420 stainless steel is extremely well balanced, ensuring increased accuracy. Sheath included. Each knife weighs 7 ounces, and is 10 1/4" long. Item No. 02GL193 \$ 51.95

8 **MAGNUM BAILEY BASIC TECHNIQUES.** John Bailey instructional knife throwing video. Available on DVD or VHS. Item No. 09JB1 \$ 24.95

9 **MAGNUM BAILEY ADVANCED TECHNIQUES.** John Bailey instructional knife throwing video. Available on DVD or VHS. Item No. 09JB2 \$ 24.95

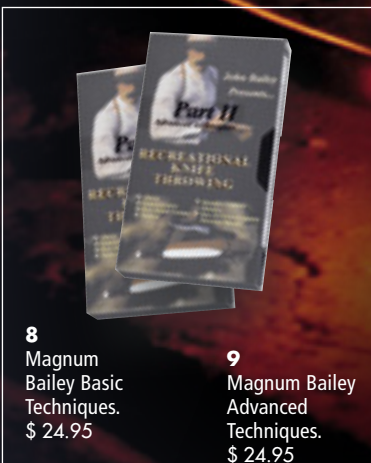

8
Magnum
Bailey Basic
Techniques.
\$ 24.95

9
Magnum Bailey
Advanced
Techniques.
\$ 24.95

MAGNUM BY BOKER

1
Magnum
Gladius
Patricius.
\$ 101.95



2
Classic
Samurai.
\$ 51.95



3
Captain
Nathan's
Sword.
\$ 133.95



4
White
Samurai.
\$ 92.95

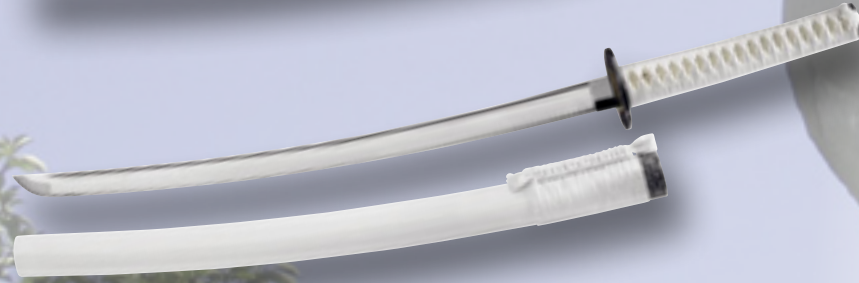

5
Blind
Samurai.
\$ 72.95

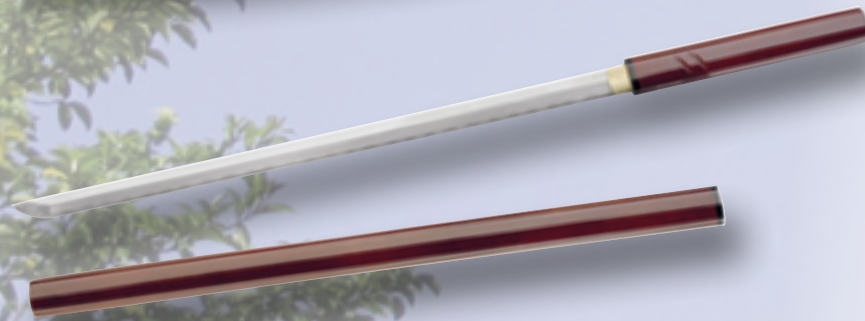

6
Manga
Sword.
\$ 51.95

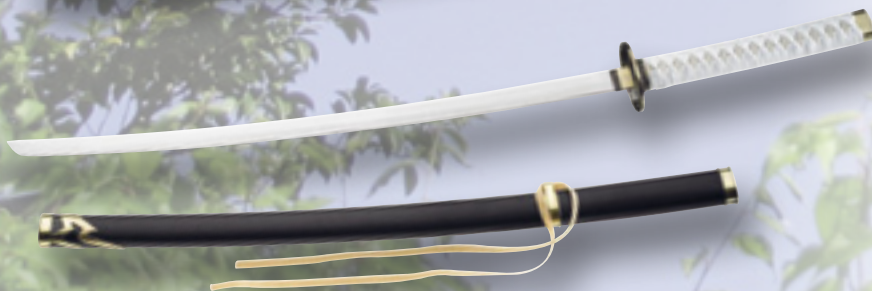

1 MAGNUM GLADIUS PATRICIUS. A shorter sword, made in accordance with the historical origin of the Roman Gladius. The magnificent handle is heavy, and has been extensively adorned with ornaments. The traditionally wide Gladius blade of this collector's piece is made of 440 stainless steel, and has a decorative cutting edge. The wooden sheath is covered with leather, and adorned with heavy metal fittings. The ornaments show traditional scenes from the era of the Roman Empire. Blade length: 19½". Overall length: 27½". Weight: 2.5 lbs. Item No. 05Z5712 \$ 101.95

2 CLASSIC SAMURAI. This traditional sword features a polished blade made of 440 stainless steel. The Tsuba (guard) is cast iron with two large openings. The handle is the classic style with a wrap over a rayskin-like under layer. The brass components provide a classic look. The wooden sheath is coated with black lacquer and antiqued fittings. Blade length: 27¼". Overall length: 41⅜". Weight: 2.4 lbs. Item No. 05Z59439 \$ 51.95

3 CAPTAIN NATHAN'S SWORD. Own the sword of Captain Nathan Algren, from "The Last Samurai." This sword is truly beautiful, crafted with great attention to detail, and will be the highlight of your collection. Engraved on the 1045 carbon steel blade are the Kanji, "I belong to the warrior in whom the old ways have joined the new." The authentic, traditionally wrapped handle with rayskin-like underlay, two Mekugis and Menukis make this a first class replica. Includes a shiny black lacquered scabbard and cotton storage bag. Blade length: 28". Overall length: 40½". Weight: 3 lbs. Item No. 05Z5610 \$ 133.95

4 WHITE SAMURAI. A unique and visually striking sword, in all white. The sheath is white lacquered wood, and the handle wrap and rayskin-like underlay are white. For contrast, the fittings are antiqued silver. The blade is 1045 carbon steel, separated from the handle by a Tsuba with a dragon motif. Includes a decorative presentation box. Blade length: 28". Overall length: 40½". Weight: 3 lbs. Item No. 05Z5642 \$ 92.95

5 BLIND SAMURAI. The sword of the blind wanderer, this is a Shirasaya style sword without a Tsuba (guard), and no decorative fittings. On the wooden handle, there are two notches to indicate the edge orientation of the straight 1045 carbon blade. The sheath is made of lacquered wood. Blade length: 29". Overall length: 41⅜". Weight: 2.3 lbs. Item No. 05Z5600 \$ 72.95

6 MANGA SWORD. A very traditional appearing Samurai sword. The 1045 carbon steel blade is finely polished, and the ornate Tsuba is an ideal match

for the black lacquered scabbard. The combination of the white wrapping over the white rayskin-like handle offers a very special appearance. Blade length: 27". Overall length: 43". Weight: 2.7 lbs. Item No. 05ZS594 \$ 51.95

7 MAGNUM RED SHOGUN. This intricately decorative sword will look great as a home showpiece. The blade is made of 440 stainless steel with a two-toned finish. The Tsuba and fittings on the handle boast an antique brass finish. The lacquered scabbard is very eye catching, with a burgundy tone and fine black complements. Blade length: 25¾". Overall length: 38¼". Weight: 1.6 lbs. Item No. 05ZS9413 \$ 61.95



8 RED SAMURAI. This is a truly premium sword. The traditional handle, with its red wrapping and white rayskin-like underlay, has two Menukis (dragon ornaments) and two Mekugis (bamboo pegs) to secure the blade to the handle - just two of the powerful features of this masterful sword. An ornate decorative Tsuba separates the handle from the hand forged 1045 carbon steel blade. The slightly antiqued finish makes this sword look even more authentic. Includes a black lacquered wooden sheath and traditional sword care kit. Blade length: 28". Overall length: 40½". Weight: 3 lbs. Item No. 05ZS579 \$ 92.95

9 BLEACH SWORD "ICHIGO". An impressive sword from the BLEACH Manga Series. The sword of Ichigo has a 3¾" wide carbon steel blade, which is blackened and has a high polished cutting edge, lending it a complex, decorative character. The wooden handle is wrapped with white cloth, and the sheath is designed to be carried on the back. Blade length: 29". Overall length: 42½". Weight: 4.1 lbs. Item No. 05ZS586 \$ 61.95



10
Sword Stand.
\$ 25.95

10 SWORD STAND. This handsome stand is made of black lacquered wood, and allows you to proudly display your sword. The sword rest is lined with red felt, to prevent scratching to your sword or its sheath, and the legs have felt feet, to prevent it from scratching the surface you choose to display your collection on. Height: 7¾". Width: 15½". Item No. 09ZS1104 \$ 25.95

11 HANDFORGED DAMASCUS SAMURAI SWORD. This high quality sword will impress at first glance! From its 200-layer hand forged Damascus blade to its authentic rayskin-like handle with Menukis under the wrap, this jewel of a sword would identify the social status of a ranking Samurai. The decorative Tsuba has a Japanese motif with a slightly antiqued finish. The wooden sheath is high polished black lacquer. Includes a sword care kit and storage bag. Blade length: 28". Overall length: 40½". Weight: 3.2 lbs. Item No. 05ZS580 \$ 154.95

12 HANDFORGED BLACK DAMASCUS NINJA SWORD. This is an impressive weapon! Unlike the Katana, a Ninja-To is straight instead of curved, and has a square Tsuba. This hand forged blade is made of 200-layer Damascus steel, which adds to the exceptional character of this fine sword.

The black wrapped handle includes two Menukis, and fits comfortably in your hand. Includes a black lacquered wooden sheath and a cotton storage bag. Blade length: 28". Overall length: 40½". Weight: 3.1 lbs. Item No. 05ZS597 \$ 154.95

**GENUINE FORGED
DAMASCUS BLADES!**



7
Magnum
Red Shogun.
\$ 61.95



8
Red
Samurai.
\$ 92.95

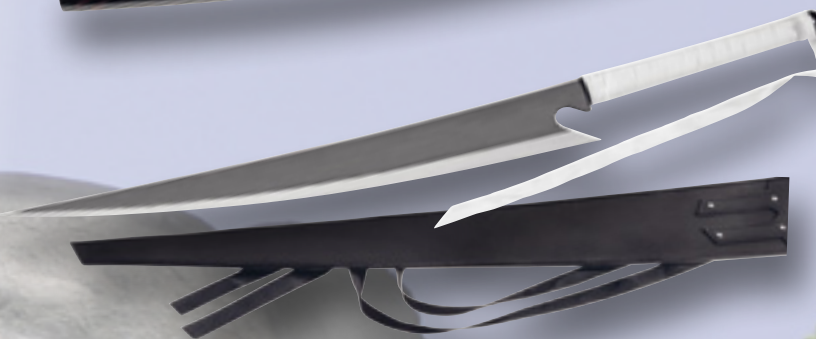

9
Bleach Sword
"Ichigo".
\$ 61.95



11
Handforged
Damascus Samurai
Sword.
\$ 154.95



12
Handforged Black
Damascus Ninja
Sword.
\$ 154.95



ACCESSORIES

by BÖKER

Equipment:
The details that make life easier.
[Pages 140-155]



1 BOKER PLUS MPP - MULTI PURPOSE PEN. With this versatile new pen, you are prepared for anything! It not only serves as a high quality writing tool and a stylus for a smart phone or tablet, it also features a glass breaker tip in case of emergency, and can be used as a kubotan for self defense. The sturdy clip keeps it readily accessible at all times, and the screwed on cap prevents accidental separation. The deep finger grooves provide superior comfort. To change the ink cartridge, simply unscrew the pen counter clockwise, to prevent accidental disassembly. Compatible with Fisher Space Pen cartridge #PR4, which can be purchased at www.spacepen.com. Diameter (cap): 13.9mm. Overall length: 6". Weight: 1.4 oz. Item No. 09B0091 \$ 26.95



1
Boker Plus
MPP - Multi
Purpose Pen.
\$ 26.95

2 BOKER PLUS TACTICAL PEN CID CAL .45 GEN 2. This ingenious design by Rainer Wenning and knifemaker Thomas Braunagel will be a must for those wanting a tactical pen with a twist. The "bolt action" mechanism and "click" open and close will make it difficult to put this piece down. The flat pen head provides a secure thumb rest, making it an effective self defense tool as well. The Clip Integrated Design (CID) offers the advantage of easy placement in the pocket. The sturdy clip has minimal give to provide a comfortable draw resistance in normal tactical or denim pants pockets. The body of this new tactical pen, CID .45 CAL is hardcoat anodized CNC milled aluminum, providing style and optimum ergonomics. Black finish. *Not a firearm.* Compatible with LAMY #M22 ink refills, which can be purchased at www.lamyusa.com. Overall length: 5". Item No. 09B0085 \$ 61.95

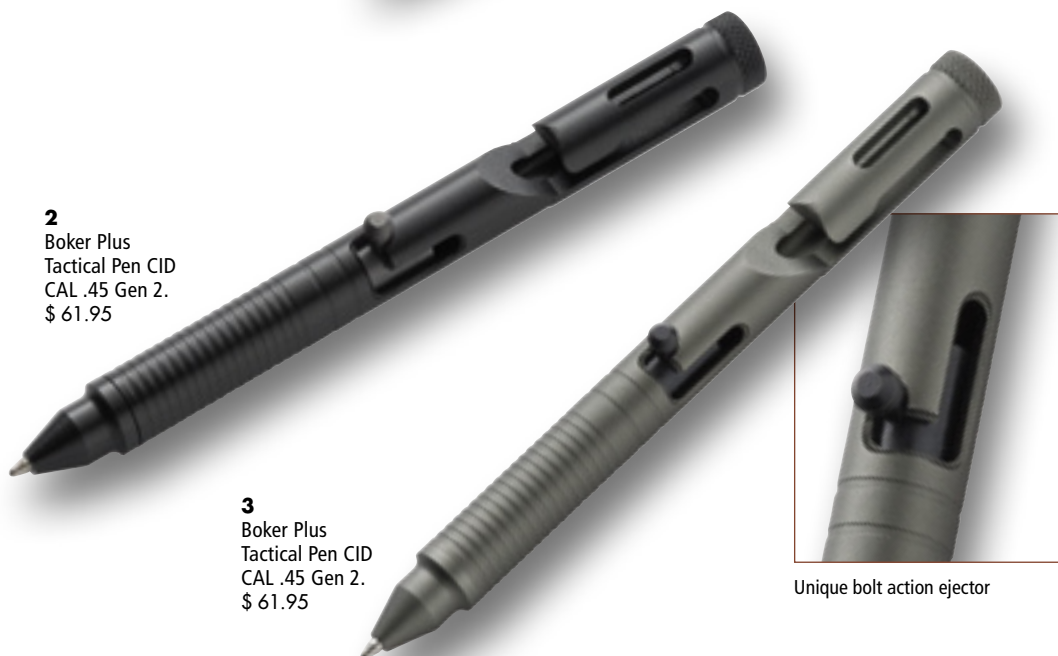

2
Boker Plus
Tactical Pen CID
CAL .45 Gen 2.
\$ 61.95

3
Boker Plus
Tactical Pen CID
CAL .45 Gen 2.
\$ 61.95

Unique bolt action ejector

3 BOKER PLUS TACTICAL PEN CID CAL .45 GEN 2. Same features and specifications as model 09B0085 (above), with a titanium gray finish. *Not a firearm.* Compatible with LAMY #M22 ink refills, which can be purchased at www.lamyusa.com. Item No. 09B0086 \$ 61.95

4 BOKER PLUS TACTICAL PEN. An innovative new development joins the Boker Plus line. Made from lightweight but sturdy aluminum, this tactical pen features a black anodized body, with a checkered body and cap to provide a secure grip. The Boker Plus Tactical Pen also has a hard, rounded stainless steel insert on the shaft end, which allows it to be used as a Kubotan. The cap has a precision screw and is secured by an internal o-ring. To write, the optional cap can be easily slipped back to the stylus. Compatible with Fisher Space Pen refills. Overall length: 6". Diameter: 13mm. Weight: 2 oz. Item No. 09B0090 \$ 31.95



4
Boker Plus
Tactical Pen.
\$ 31.95





1
Boker Plus FC-1.
\$ 46.95



2
Boker Plus FC-2.
\$ 56.95

POUCHES AND
BATTERIES AVAILABLE!
See page 144.



3
Boker Plus FA-1.
\$ 46.95



4
Boker Plus FA-2.
\$ 56.95

BOKER PLUS FLASHLIGHTS. These new flashlights from Boker Plus feature the same characteristics which have made our Boker Plus line so successful - modern materials, innovative design, and an outstanding price-performance ratio. The hardcoated aluminum bodies have a tactical switch at the end for momentary or constant light. All flashlights feature a Cree R5 LED with two modes, that can be chosen

by a simple half twist of the head, even when switched off. The non-slip checkering, detachable pocket clips and simple usage make these flashlights versatile and reliable companions for hunting, outdoors, and general everyday use. Available in six models:

1 BOKER PLUS FC-1. The most compact light in the series, running with only one CR123 lithium battery. With an overall length of 3 $\frac{3}{8}$ " , it fits easily in any pocket. Offers two modes, for 200/70 lumens. Includes lanyard, detachable pocket clip, o-ring and spare rubber push button cap. Watertight according to IPX-6. Diameter: $\frac{7}{8}$ ". Weight: 1.8 oz. Item No. 09B0801 \$ 46.95



5
Boker Plus FC-3.
\$ 67.95



6
Boker Plus FA-3.
\$ 70.95

2 BOKER PLUS FC-2. This flashlight delivers an impressive 224 lumens, with two CR123 batteries on the high output. The second mode reduces the setting to 70 lumens, which is activated by twisting the head. Includes lanyard, detachable pocket clip, o-ring and spare rubber push button cap. Watertight according to IPX-6. Overall length: 4". Diameter: 7/8". Weight: 2.3 oz. Item No. 09B0802 \$ 56.95

3 BOKER PLUS FA-1. Same features as the other models, but this model runs on one AA battery, reducing the running cost. Offers two modes, for 105/35 lumens. Includes lanyard, detachable pocket clip, o-ring and spare rubber push button cap. Watertight according to IPX-6. Overall length: 3 7/8". Diameter: 5/8". Weight: 1.5 oz. Item No. 09B0804 \$ 46.95

4 BOKER PLUS FA-2. This classic mini pen light can be carried and used comfortably, even with gloves on. Running on two AA batteries, it offers two modes, for 152/50 lumens, which can be adjusted by rotating the head. Includes lanyard, detachable pocket clip,

o-ring and spare rubber push button cap. Watertight according to IPX-6. Overall length: 5". Diameter: 5/8". Weight: 2.2 oz. Item No. 09B0805 \$ 56.95

5 BOKER PLUS FC-3. The tactical model in the series. The diameter of the head, which is 1 1/4", gives it enormous reach, and the detachable pocket clip and tactical ring make it suitable not only for duty, but also for hunting, outdoor and everyday use. Features two settings, for 322/114 lumens, and runs on two CR123 batteries. Includes lanyard, detachable pocket clip, o-ring and spare rubber push button cap. Watertight according to IPX-6. Overall length: 5 1/2". Diameter (body): 7/8". Weight: 4 oz. Item No. 09B0803 \$ 67.95

6 BOKER PLUS FA-3. With its large diameter of 1 1/2", this model convinces with an extraordinary light output for longer distance. Despite its powerful light of 459/155 lumens, this model is still compact enough to be handy. Runs on four AA batteries (included). Includes lanyard, o-ring and spare rubber push button cap. Watertight according to IPX-6. Overall length: 5". Diameter (body): 1 5/8". Weight: 8 oz. Item No. 09B0806 \$ 70.95



Flashlights come packaged in stylish gift boxes.

ACCESSORIES





1
Boker Plus Weatherproof
Notebook Large.
\$ 7.95



Checked pages.

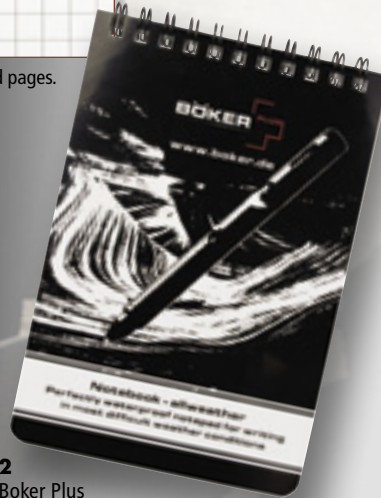

2
Boker Plus
Weatherproof
Notebook Small.
\$ 5.95

3
Boker Plus Nylon
Pouch FC-2.
\$ 5.95



4
Boker Plus Nylon
Pouch FC-1.
\$ 5.95



5
Boker Plus
Batteries CR123.
\$ 13.95

BOKER PLUS WEATHERPROOF NOTEBOOKS. These new notebooks feature weatherproof paper, that can be used in heavy rain, or even under water, as the paper will not soak. Perfect for all outdoor activities and professional missions (military, police, firefighters, rescue teams, etc.). The pages feature checkered lines, and can be written on with a standard ball point pen or pencil. Available in two sizes:

1 BOKER PLUS WEATHERPROOF NOTEBOOK LARGE. 45 pages.
Size: 4" x 6".
Item No. 09B0191 \$ 7.95

2 BOKER PLUS WEATHERPROOF NOTEBOOK SMALL. 45 pages.
Size: 3 1/8" x 4 3/4".
Item No. 09B0192 \$ 5.95

BOKER PLUS NYLON POUCHES. These high quality nylon pouches are designed exclusively for our Boker Plus flashlights (shown on page 142-143). Available in six sizes:

3 BOKER PLUS NYLON POUCH FC-2. Nylon pouch for the FC-2 flashlight (model 09B0802).
Item No. 090802 \$ 5.95

4 BOKER PLUS NYLON POUCH FC-1. Nylon pouch for the FC-1 flashlight (model 09B0801).
Item No. 090801 \$ 5.95

BOKER PLUS NYLON POUCH FA-1. Nylon pouch for the FA-1 flashlight (model 09B0804). *Not pictured.*
Item No. 090804 \$ 5.95

BOKER PLUS NYLON POUCH FA-2. Nylon pouch for the FA-2 flashlight (model 09B0805). *Not pictured.*
Item No. 090805 \$ 5.95

BOKER PLUS NYLON POUCH FC-3. Nylon pouch for the FC-3 flashlight (model 09B0803). *Not pictured.*
Item No. 090803 \$ 5.95

BOKER PLUS NYLON POUCH FA-3. Nylon pouch for the FA-3 flashlight (model 09B0806). *Not pictured.*
Item No. 090806 \$ 5.95

5 BOKER PLUS BATTERIES CR123. Pack of four CR123 batteries.
Item No. 09B0123 \$ 13.95

BOKER PLUS BATTERIES AA. Pack of four AA batteries. *Not pictured.*
Item No. 09B0124 \$ 4.95

6 BOKER PLUS TITANIUM DOG TAG SMALL. High quality titanium dog tag, left blank for personalization/ engraving (this service is not available through Boker USA). Includes ball chain. Dimensions: 1" x 1½". Weight: 0.2 oz. Item No. 09B0513 \$ 16.95



NEW

6
Boker Plus
Titanium
Dog Tag
Small.
\$ 16.95

7 BOKER PLUS TITANIUM DOG TAG LARGE. High quality titanium dog tag, left blank for personalization/ engraving (this service is not available through Boker USA). Includes ball chain. Dimensions: 1½" x 2". Weight: 0.4 oz. Item No. 09B0514 \$ 19.95



NEW

7
Boker Plus
Titanium Dog
Tag Large.
\$ 19.95

BOKER PLUS SO4PRO-K POCKET STICKS. These new SO4PRO-K Pocket Sticks have been developed as innovative alternatives to other koppo sticks available by Rainer Wenning for Boker. Designed for defensive use, as well as a capable massage tool for relaxation of muscle tightness using the innovative rounded tip. The double finger loop in the middle of the shaft allows you to hold the koppo and use your hands without having to put the koppo down, and prevents dropping or losing the koppo while using it in a defensive situation. A very effective and versatile tool! Available in two versions:

8 BOKER PLUS SO4PRO-K TITANIUM. This exclusive version is made entirely of Grade 4 titanium. Overall length: 5¼". Weight: 2.8 oz. Item No. 09B0071 \$ 51.95

8
Boker Plus
SO4PRO-K
Titanium.
\$ 51.95

9 BOKER PLUS SO4PRO-K STEEL. This version is made of solid stainless steel, with a high grade titanium coating. Overall length: 5¼". Weight: 4.9 oz. Item No. 09B0070 \$ 31.95

9
Boker Plus
SO4PRO-K Steel.
\$ 31.95

10 BOKER PLUS WAVES MFS TITAN. A multi functional pocket stick, designed by Rainer Wenning. Inspired by the SO4PRO-K pocket sticks and the CID CAL .45 pens, we now introduce the Waves MFS, which also serves multiple purposes. For one, it is, according to Rainer Wenning's interpretation, a palm stick that makes a safe and secure tool in a self defense situation. In addition, it makes for an extraordinary massage tool, especially for foot reflex massage, to stimulate trigger points, or for acupressure usage. Consequently, Rainer calls his design a "physio-tactical product." This aesthetic, functional, high quality tool is made by Boker Plus, out of pure titanium, and is eudermic and comfortable in the hand. Diameter: 22mm. Overall length: 6". Weight: 5.5 oz. Item No. 09B0075 \$89.95

NEW



10
Boker Plus
Waves MFS
Titan.
\$ 89.95

ACCESSORIES



A sharp knife is a safe knife.

1
Shiageto.
\$ 61.95



2
Nakato.
\$ 49.95



3
Arato.
\$ 43.95



4
6000 King
Sharpening
Stone.
\$ 99.95



5
King Combination
Sharpening
Stone.
\$ 99.95



JAPANESE BENCHSTONES.

The secret of the world-famous sharpness and edge retention of Japanese blades is based on the quality of the steel and the manufacturing processes that were brought to perfection over hundreds of years. Nevertheless, even the best blades need some care and maintenance on a regular basis. Our new line of original Japanese sharpening stones, made by Masahiro, are the perfect tool to maintain and restore your blades to that extremely high level of sharpness. The stones consist of a water soluble matrix – by wetting the stone before use, fresh sharpening particles are permanently exposed during the sharpening process, which creates maximum sharpening ability. The stones should be handled according to

the traditional method of Japanese sharpening, and never without water. The result will be more than satisfying! Size: 7" x 2". Height is approximately 3/4".

1 SHIAGETO. Fine (1500 grit). For honing high performance blades. Item No. 09KE182 \$ 61.95

2 NAKATO. Medium (1000 grit). Perfect for honing, for razor sharp blades. Item No. 09KE183 \$ 49.95

3 ARATO. Rough (600 grit). For reshaping dull blades or small nicks in the blade. Item No. 09KE184 \$ 43.95

4 6000 KING SHARPENING STONE. A Japanese brand stone with a very fine grit (6000), for the experienced user. Includes sharpening stone holder. Dimensions: 7 1/2" x 2 3/4" x 1". Item No. 09KE181 \$ 99.95

5 KING COMBINATION SHARPENING STONE. A combination Japanese stone with 800 and 6000 grits for sharpening and honing of high quality knives. Includes sharpening stone holder. Dimensions: 7 1/2" x 2 3/4" x 1 1/4". Item No. 09KE180 \$ 99.95

MAGNUM KNIFE SHARPENERS.

This series of knife sharpeners under the Magnum brand provide outstanding performance. The high quality in material selection and production offers all you need for excellent sharpening results. Universally applicable for all types of knife blades.

6 MAGNUM SHARPENING STONE 240/800. This sharpening stone features two different grain sizes. The 240 grain has been designed for rough grinding, and the 800 for fine grinding. The slip-resistant rubber foot rests securely on a flat surface, thus allowing safe and comfortable work. Length: 7 1/8". Width: 2 1/2". Height: 1 1/4". Weight: 23.3 oz. Item No. 09TT851 \$ 31.95



6
Magnum
Sharpening
Stone 240/800.
\$ 31.95



7
Magnum
Sharpening
Stone 1000.
\$ 25.95



8
Magnum
Ceramic
Knife
Sharpener.
\$ 16.95



9
Magnum
Diamond
Knife
Sharpener.
\$ 20.95



10
Sieger
Long Life
Sharpener.
\$ 89.95

7 MAGNUM SHARPENING STONE 1000. This 1000 grit stone is designed for the demanding user. The result is a very fine sharpening, and ensures easy and reliable operation with any knife. Non-slip stone holder included. Length: 7 1/8". Width: 2 1/2". Height: 7/8". Weight: 10.6 oz.. Item No. 09TT911 \$ 25.95

8 MAGNUM CERAMIC KNIFE SHARPENER. The ideal tool to achieve an excellent sharpening result quickly. The two-stage cut will turn the dullest knife into a sharp instrument. In the first stage (coarse), pull the blade through the carbide sharpener with a basic cut. The second stage (fine) smooths the cutting edge by grinding ceramic rods, and provides the finishing touch. Suitable for both plain edge and serrated blades. The grinding unit is

removable and can be used right or left handed. Also features a stable, non-slip base. Length: 7 1/2". Width: 2 3/8". Height: 2 1/2". Weight: 4.4 oz. Item No. 09TT901 \$ 16.95

9 MAGNUM DIAMOND KNIFE SHARPENER. The sharpening device for long lasting sharpness. This application requires no training or previous experience. The two-stage grinding sharpens dull blades easily and efficiently. In the first stage, two diamond-coated carbide wheels ensure the blade is at the perfect angle. The second stage consists of fine grinding ceramic wheels, for a long lasting polish. Also features a stable, non-slip base. Length: 7 7/8". Width: 2 3/8". Height: 2 1/2". Weight: 6 oz. Item No. 09TT005 \$ 20.95

10 SIEGER LONG LIFE SHARPENER. This sharpener, made of synthetic ruby, is 20 times harder than hardened steel (20,000 Knoop hardness, which is roughly a 200 hardness in Rockwell units)! The most unusual aspect of this sharpener is the high efficiency (taking less time for sharpening), in combination with an extraordinarily fine edge, allowing superior edge retention. In addition, this sharpener will last longer than a diamond sharpener, as it is not a coated instrument but one of bulk material. Can be used either wet or dry, and can be simply cleaned with a dish sponge. Length: 8". Item No. 09SR001 \$ 89.95



SHARPENS
CERAMIC BLADES!



1
Work Sharp®
Knife & Tool
Sharpener.
\$ 99.95

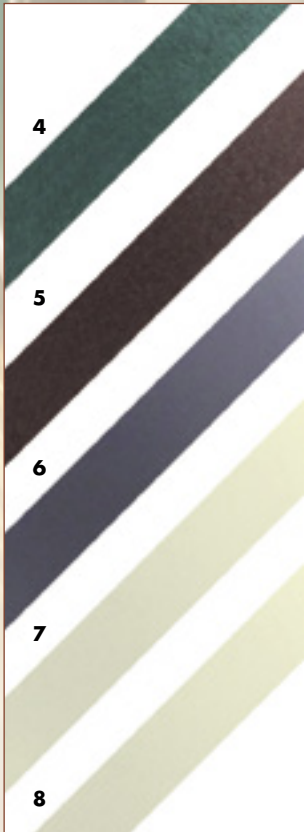

4

5

6

7

8



2
Work Sharp® 40°
Outdoor Knife
Guide.
\$ 12.95

NEW



3
Work Sharp®
Guided Field
Sharpener.
\$ 34.95



9

WORK SHARP® KNIFE & TOOL SHARPENER. The Work Sharp Knife & Tool Sharpener is the first knife sharpener designed to sharpen every knife you own. Using flexible abrasive belts, the sharpener is able to sharpen not just straight bladed knives, but also curved knives, tanto blades, fillet knives, serrated blades, gut hooks, and virtually any other shape of knife blade. The Knife & Tool Sharpener uses precision angle sharpening guides to ensure the proper angle every time. Two guides are included: a 50° guide for hunting and outdoor knives (25° per bevel), and a 40° guide for thinner blades and kitchen knives (20° per bevel). This combination of flexible belts and precision guides lets you sharpen your blade to hair popping results with speed, ease and repeatability. This is the fastest and easiest way

to get your knives as sharp as you need them to be. Stop tolerating dull knives and time consuming sharpening methods!

Professional knife makers use flexible belts to put a razor sharp edge on their blades, and now you can have the same technology at home to use any time your knives get dull. You may already have other sharpening methods, but never before has a knife sharpener been able to quickly and easily sharpen this broad range of knives to such extremely sharp results.

The Work Sharp Knife & Tool Sharpener is also able to sharpen other common tools including scissors, axes and hatchets, mower blades, garden shears, shovels, and just about any tool with a blade. Can

even sharpen ceramic blades, when used with a diamond abrasive belt (models 09DX014 and 09DX015). The versatility of the Knife & Tool Sharpener makes it an invaluable tool for keeping all your blades in razor sharp condition and ready whenever you need them.

1 WORK SHARP® KNIFE & TOOL SHARPENER. Includes abrasive belt kit (P80, P220 and 6000), kitchen guide, outdoor knife guide (model 09DX020), carry bag, instructional DVD and user's manual.
Item No. 09DX003 \$ 99.95

2 WORK SHARP® 40° OUTDOOR KNIFE GUIDE. Optional outdoor knife guide with a 40° angle (20° per bevel), as an alternative to the included 50° guide.
Item No. 09DX020 \$ 12.95



Glass breaker tip

10
Boker Plus
Access Tool.
\$ 41.95



3 WORK SHARP® GUIDED FIELD SHARPENER 2.2.1. The GFS 221 is a compact sharpener designed specifically for use in the field. Five abrasive steps provide the complete sharpening solution. The built in angle guides ensure a consistent bevel angle across the entire edge of a blade. All elements are self contained and require no set-up or assembly in the field. Sharpens plain and serrated blades, scissors, fish hooks, garden tools, broadheads, axes, machetes, and so much more! Also features a lanyard hole for easy carry. Item No. 09DX100 \$ 34.95

4 WORK SHARP® P80 CERAMIC OXIDE ABRASIVE BELT. Six-pack of P80 abrasive belts for the WSKTS. Intended for coarse shaping and tool sharpening applications. Use caution to avoid heat on thin blades near the tip. Use to change bevel angle, shape blade or repair chips. Great for light duty deburring and rust/paint removal. Item No. 09DX011 \$ 11.95

5 WORK SHARP® P220 CERAMIC OXIDE ABRASIVE BELT. Six-pack of P220 abrasive belts for the WSKTS. Intended for light shaping and sharpening applications. Produces a toothy cutting edge for long life utility applications. Item No. 09DX012 \$ 11.95

6 WORK SHARP® 6000 SILICON CARBIDE ABRASIVE BELT. Six-pack of 6000 abrasive belts for the WSKTS. Intended for honing applications - similar to honing with a leather strop. Provides an extremely fine edge for a razor quality shave, and is highly conformable to hone gut hooks and serrated edges. Very cool cutting for the most delicate blades, such as razors and scalpels. Item No. 09DX013 \$ 11.95

11
Boker Toolkit
Torx.
\$ 19.95



12
Boker Toolkit
Hex.
\$ 19.95



7 WORK SHARP® DIAMOND 180 ABRASIVE BELT. A single diamond abrasive belt, intended for shaping and coarse sharpening of ceramic blades. Not intended for steel blades. Features an ultra flexible cloth backing with very hard/sharp diamond abrasive. Item No. 09DX014 \$ 11.95

8 WORK SHARP® DIAMOND 1500 ABRASIVE BELT. A single diamond abrasive belt, intended for honing and fine sharpening of ceramic blades. Not intended for steel blades. Features an ultra flexible cloth backing with very hard/sharp diamond abrasive. Item No. 09DX015 \$ 11.95

9 WORK SHARP® ASSORTED BELT KIT. Six-pack of abrasive belts. Includes two P80 Coarse Grit Belts, two P220 Medium Grit Belts, and two 6000 Fine Grit Belts. These engineered abrasives are 1/2" x 12", and are made exclusively for the WSKTS. Item No. 09DX010 \$ 11.95

10 BOKER PLUS ACCESS TOOL. For a long time we have been looking for a good multi-purpose prying tool for the keyring or pocket, and couldn't find anything satisfying. So we started our own project, together with Jesper Voxnaes. The result is the Boker Plus VAT, which not only comes in handy for prying tasks, but also works great as a bottle opener, nail puller, shackle opener and carabiner. A highlight of this versatile tool is the carbide glass-breaker, which is located between the two protective o-rings. The VAT is crafted of titanium, making it extremely lightweight at less than one ounce! Thickness: 5mm. Overall length: 3 3/8". Weight: 0.7 oz. Item No. 09B0310 \$ 41.95

only convenient, but ergonomically designed and supplied with high quality bits for intricate work. The bits are stored inside of the handle to prevent loss. A must-have tool for the knife enthusiast! Overall length: 2 1/2". Available in two versions:

11 BOKER TOOLKIT TORX. Contains Torx bits 4 / 5 / 6 / 7 / 8 / 10 / 15. Item No. 09B0700 \$ 19.95

12 BOKER TOOLKIT HEX. Contains Hex bits 1.5 / 2 / 2.5 / 3 / 4 / 5. Item No. 09B0701 \$ 19.95

BOKER TOOLKITS. A convenient tool kit that will help whether you want to reverse a clip or dismantle your knife for cleaning purposes. This toolkit, made in Germany, is not

ACCESSORIES
by BOKER

ACCESSORIES

For that added touch.

1
Monkey Fist.
\$ 22.95



2
Monkey Fist.
\$ 24.95



GLOW
in the
DARK

3
Gorilla Fist.
\$ 22.95



MONKEY FISTS. A stylish addition for your gear. Monkey Fists assist in quickly drawing your knife from your pocket or sheath, and also make convenient extensions on zippers or keychains. The inner core is a 3/4" chrome steel ball for ideal weight, and the surrounding para-cord is hand-tied. The loop is tied in a slip knot for maximum versatility. Available in three colors:

1 MONKEY FIST. Black.
Item No. 09WT101 \$ 22.95

2 MONKEY FIST. Olive, with glow-in-the-dark threads.
Item No. 09WT103 \$ 24.95

3 GORILLA FIST. The great success of the classic Monkey Fist created the demand for a larger size. The Gorilla Fist is the answer! Instead of the 3/4" steel ball, the Gorilla Fist features a steel ball with a 1 1/4" diameter. Maximum loop length is about 11" (adjustable).
Item No. 09WT111 \$ 22.95

LANYARDS. The lanyards offered by Wilson Tactical are almost legendary by now. These hand tied lanyards, made of high-strength paracord, add that extra something to every knife, are very useful and allow for a variety of applications: helps in drawing any folder or fixed blade knife, gives extra grip to any zipper (on jackets, bags and backpacks), works as a grip extension for smaller knives or flashlights, personalizes your gear (jackets, bags, key rings, etc.). Available with skull or plastic bead.

4 LANYARD. WT orange/black, bead.
Item No. 09WT006 \$ 12.95

5 LANYARD. WT black/olive, bead.
Item No. 09WT003 \$ 12.95

6 LANYARD. WT desert/brown, bead.
Item No. 09WT004 \$ 12.95

7 LANYARD. WT black/black, skull.
Item No. 09WT001 \$ 12.95

8 LANYARD. WT black/grey, skull.
Item No. 09WT002 \$ 12.95

9 LANYARD. WT blue/black, skull.
Item No. 09WT005 \$ 12.95

10 LANYARD. WT digital camo, skull.
Item No. 09WT012 \$ 13.95

4
Lanyard.
\$ 12.95



5
Lanyard.
\$ 12.95



6
Lanyard.
\$ 12.95



7
Lanyard.
\$ 12.95

8
Lanyard.
\$ 12.95



9
Lanyard.
\$ 12.95

10
Lanyard.
\$ 13.95



11
Lanyard.
\$ 13.95



12
Lanyard.
\$ 12.95



13
Lanyard.
\$ 12.95



14
Lanyard.
\$ 12.95



GLOW
in the
DARK

15
Lanyard.
\$ 12.95



GLOW
in the
DARK

GLOW
in the
DARK

GLOW
in the
DARK

In collaboration with:



**WILSON
TACTICAL**

11 LANYARD. WT woodland camo, skull.
Item No. 09WT011 \$ 13.95

12 LANYARD. WT foliage green, glow-in-the-dark bead.
Item No. 09WT010 \$ 12.95

13 LANYARD. WT olive/glow-in-the-dark, black bead.
Item No. 09WT009 \$ 12.95

14 LANYARD. WT red/white, glow-in-the-dark bead.
Item No. 09WT007 \$ 12.95

15 LANYARD. WT blue/white, glow-in-the-dark bead.
Item No. 09WT008 \$ 12.95

SURVIVAL BRACELET. Don't leave home without one! A professional survival bracelet of braided paracord, with a high quality Fastex snap closure. Provides a constant reserve supply of paracord, for any emergency situation. Available in two sizes and four colors:

16 8" SURVIVAL BRACELET. Coyote.
Item No. 09JG242 \$ 13.95

16A 9" SURVIVAL BRACELET. Coyote.
Item No. 09JG243 \$ 13.95

17 8" SURVIVAL BRACELET. Digital camo.
Item No. 09JG222 \$ 13.95

17A 9" SURVIVAL BRACELET. Digital camo.
Item No. 09JG223 \$ 13.95

18 8" SURVIVAL BRACELET. Olive drab.
Item No. 09JG232 \$ 13.95

18A 9" SURVIVAL BRACELET. Olive drab.
Item No. 09JG233 \$ 13.95

19 8" SURVIVAL BRACELET. Black.
Item No. 09JG202 \$ 13.95

19A 9" SURVIVAL BRACELET. Black.
Item No. 09JG203 \$ 13.95

PARACORD. After numerous customer requests, we now offer Paracord 550, from Wilson Tactical. An important addition to your survival gear, this paracord has a tensile strength of 550 lbs., and can also be used for handle wrappings, lanyards, decorative knots, you name it! Overall length: 49.2 ft. Available in six colors:

20 PARACORD. Olive.
Item No. 09WT301 \$ 12.95

21 PARACORD. Coyote.
Item No. 09WT302 \$ 12.95

22 PARACORD. Orange.
Item No. 09WT305 \$ 12.95

23 PARACORD. Woodland camo.
Item No. 09WT306 \$ 12.95

24 PARACORD. Desert camo.
Item No. 09WT304 \$ 12.95

25 PARACORD. Black.
Item No. 09WT300 \$ 12.95

16 & 16A
Survival Bracelet.
\$ 13.95



17 & 17A
Survival Bracelet.
\$ 13.95



19 & 19A
Survival Bracelet.
\$ 13.95



18 & 18A
Survival Bracelet.
\$ 13.95

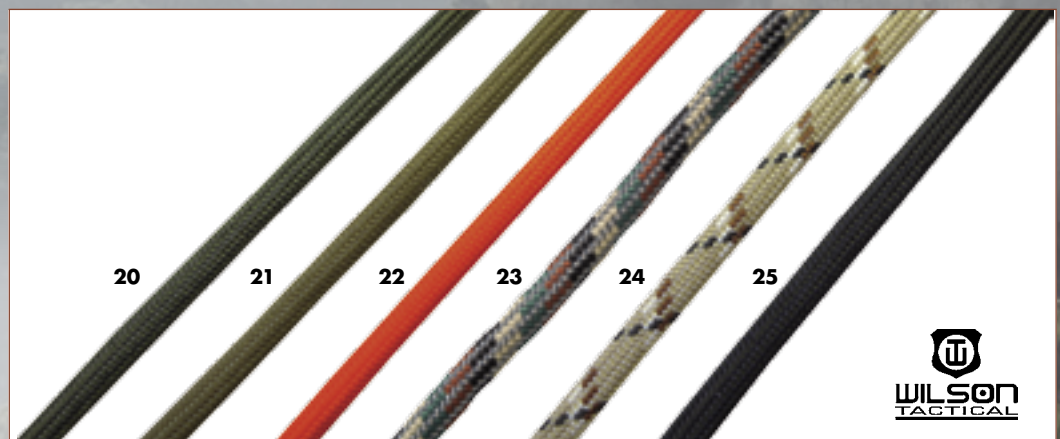

To fit all your needs.

1
Boker Leather Sheath & Chain.
\$ 24.95



2
Boker Leather Sheath.
\$ 24.95



3
Boker Optima Sheath.
\$ 69.95



4
Boker Optima Sheath.
\$ 13.95



1 BOKER LEATHER SHEATH & CHAIN. For our famous camp knives (shown on page 36).
Item No. 090182 \$ 24.95

2 BOKER LEATHER SHEATH. Genuine high grade leather sheath, suitable for large pocket knives, such as Trappers or Stockmans.
Item No. 090035 \$ 24.95

3 BOKER OPTIMA SHEATH. Genuine leather sheath provides compact storage for the Optima knife and three spare blades (Optima Series shown on page 32).
Item No. 090046 \$ 69.95

4 BOKER OPTIMA SHEATH. Optima Cordura nylon belt sheath with an extra compartment for one spare blade (Optima Series shown on page 32).
Item No. 090047 \$ 13.95

5 BOKER LEATHER SHEATH. This premium leather sheath is ideal for our 112020 Series, and model 114021S (all shown on page 35). Also suitable for similar knives up to 5¼" closed.
Item No. 092020 \$ 37.95

6 BOKER LEATHER SHEATH. For Models 113000 and 114000 (both shown on page 34).
Item No. 090032 \$ 28.95

7 BOKER LEATHER SHEATH. For the 112002 Series (shown on page 33).
Item No. 090033 \$ 37.95

8 BOKER LEATHER SHEATH. For the 112020 Series, and model 114021S (all shown on page 35).
Item No. 090034 \$ 27.95

5
Boker Leather Sheath.
\$ 37.95



6
Boker Leather Sheath.
\$ 28.95



7
Boker Leather Sheath.
\$ 37.95



8
Boker Leather Sheath.
\$ 27.95





9
Boker Top
Lock Sheath.
\$ 11.95



10
Boker Top Lock II
Sheath.
\$ 11.95



11
Boker Plus
Kalashnikov Sheath.
\$ 9.95



12
Boker Plus
Kalashnikov Sheath.
\$ 9.95

9 BOKER TOP LOCK SHEATH. This sheath for Top Lock knives has Velcro fasteners for fast on/off without unbuckling your belt. Also fits similar sized knives up to 4¾" closed length. Heavyweight black Cordura nylon. Item No. 090049 \$ 11.95

10 BOKER TOP LOCK II SHEATH. Heavyweight black Cordura nylon sheath for Top Lock II knives. Also fits similar sized knives up to 4" closed length. Item No. 090059 \$ 11.95

11 BOKER PLUS KALASHNIKOV SHEATH. Black Cordura sheath for our KAL74 Series (shown on pages 77 and 81). Also suitable for knives up to 4" closed. Item No. 090064 \$ 9.95

12 BOKER PLUS KALASHNIKOV SHEATH. Desert colored sheath for our KAL74 Series (shown on pages 77 and 81). Also suitable for knives up to 4" closed. Item No. 090065 \$ 9.95

13 IWB BELT LOOP. Rubber band with a "pull-the-dot" snap closure for safe carry of a knife inside the waistband. Made by Blade-Tech Industries. Comes in a set of two loops. Sheath shown not included. Item No. 09B0507 \$ 12.95

TEK-LOK. The Tek-Lok is an innovative belt loop system that is adaptable to many sheath systems. The locking system allows the knife to be carried in the vertical or horizontal position on your belt or web gear. Fiber reinforced nylon. Available in two sizes:

14 MINI TEK-LOK. Ideal for small and lightweight items. Fits 1.5 belts and smaller. Attaches directly to a Kydex or plastic sheath. Inner dimensions are 1.5" x 1.5". Hardware included. Item No. 09B0506 \$ 12.95

15 STANDARD TEK-LOK. Item No. 09B0505 \$ 18.95

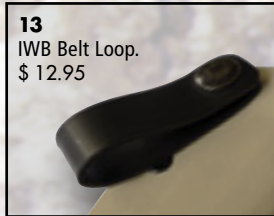

13
IWB Belt Loop.
\$ 12.95



Knife shown not included.



14
Mini Tek-Lok.
\$ 12.95

15
Standard
Tek-Lok.
\$ 18.95

ACCESSORIES



1
Boker Edition
Zippo Lighter.
\$ 39.95



2
Boker Knife
Vault Large.
\$ 31.95



3
Boker Knife
Vault Small.
\$ 24.95



4
Boker Patch
Red.
\$ 5.95



5
Boker Patch
Black.
\$ 5.95



6
Boker
Rubber Patch
Stayglow.
\$ 8.95



7
Boker Knife
Display 6.
\$ 16.95

8
Boker Knife
Display Single.
\$ 9.95



1 BOKER EDITION ZIPPO LIGHTER. The Zippo lighter has weathered many storms and graced the pockets of countless fans around the world. Boker now offers an exclusive edition of a high polished chrome lighter, embossed with the famous Boker Tree logo. Item No. 09ZP21250 \$ 39.95

2 BOKER PLUS KNIFE VAULT LARGE. This new knife case for up to twelve folding knives offers a safe storage and transportation device for the collector's valuable pieces. The Knife Vault features twelve single, separated compartments, which guarantee that even when carrying the maximum number of knives, no knife comes in contact with another,

preventing marks or scratches, while the soft inner lining prevents rubbing marks. The four exterior compartments are extra large, to easily store even oversized folders. Also features Velcro flaps, a removable Velcro business card holder, and a Velcro surface, which can be used for patches. Approximate dimensions: 16½" x 6¾". Item No. 09B0151 \$ 31.95

3 BOKER PLUS KNIFE VAULT SMALL. Same features as model 09B0151 (above), but in a smaller size. Holds up to six folding knives. Approximate dimensions: 8" x 6¾". Item No. 09B0150 \$ 24.95

BOKER PATCH. Add the Boker patches to your collection or attach to your pack or gear. The official Boker logo represents the European, South American and USA namesakes. Approximate diameter: 2". Available in two colors:

4 BOKER PATCH RED. Red patch with white embroidered logo. Item No. 090006 \$ 5.95

5 BOKER PATCH BLACK. Black patch with coyote embroidered logo. Item No. 090007 \$ 5.95

6 BOKER RUBBER PATCH STAYGLOW. This rubber patch features a three-dimensional Boker logo, with fluorescent tree and circle. Velcro hooks on the back for attaching to equipment or clothing. Diameter: 1¾". Item No. 090008 \$ 8.95

7 BOKER KNIFE DISPLAY 6. This stylish acrylic knife stand will hold up to six knives. Width: 7¾". Height: 7¾". Knife shown not included. Item No. 099949 \$ 16.95

8 BOKER KNIFE DISPLAY SINGLE. An effective means to showcase your knife, which seems to float in the air. A small magnet secures the blade in the open position. Not recommended for large or heavy knives. The base plate is 6" x 4". Height: 2". Knife shown not included. Item No. 099951 \$ 9.95

BOKER POLO SHIRT. These premium polo shirts feature an integrated pen pocket in the sleeve and a reinforced collar. The famous Boker logo is stitched on the chest and sleeves. 100% cotton. Available in the following sizes and colors:

9 BOKER POLO SHIRT BLACK. Size S. Item No. 09B0160 \$ 39.95

BOKER POLO SHIRT BLACK. Size M. Item No. 09B0161 \$ 39.95

BOKER POLO SHIRT BLACK. Size L. Item No. 09B0162 \$ 39.95

BOKER POLO SHIRT BLACK. Size XL. Item No. 09B0163 \$ 39.95

9
Boker Polo
Shirt Black.
\$ 39.95



11
Boker Cap
Black.
\$ 20.95



12
Boker Cap
Desert.
\$ 20.95



13
Boker Cap
Blackout.
\$ 20.95



10
Boker Polo
Shirt Desert.
\$ 39.95



BOKER POLO SHIRT BLACK. Size XXL.
Item No. 09B0164 \$ 39.95

BOKER POLO SHIRT BLACK. Size XXXL.
Item No. 09B0165 \$ 39.95

10 BOKER POLO SHIRT DESERT. Size S.
Item No. 09B0170 \$ 39.95

BOKER POLO SHIRT DESERT. Size M.
Item No. 09B0171 \$ 39.95

BOKER POLO SHIRT DESERT. Size L.
Item No. 09B0172 \$ 39.95

BOKER POLO SHIRT DESERT. Size XL.
Item No. 09B0173 \$ 39.95

BOKER POLO SHIRT DESERT. Size XXL.
Item No. 09B0174 \$ 39.95

BOKER POLO SHIRT DESERT. Size XXXL.
Item No. 09B0175 \$ 39.95

BOKER CAP. A very high quality six panel cap with embroidered Boker Tree logo, sewn eyelets and sweatband. Available in three colors:

11 BOKER CAP BLACK.
Item No. 09B0001 \$ 20.95

12 BOKER CAP DESERT.
Item No. 09B0002 \$ 20.95

13 BOKER CAP BLACKOUT.
Item No. 09B0101 \$ 20.95

14 BOKER BACKPACK DESERT/BLACK. A very functional backpack, with a large main compartment, two front pockets and two small mesh pockets for water bottles. Also features padded shoulder straps and side compression straps. Approximate height: 17¾". Approximate width: 13¾".
Item No. 09B0202 \$ 20.95



14
Boker
Backpack
Desert/Black.
\$ 20.95

ACCESSORIES

ACCESSORIES
by BOKER

BOKER USA, INC.

1550 Balsam Street
Lakewood, CO 80214-5917

Phone: (303) 462-0662

Fax: (303) 462-0668

Email: sales@bokerusa.com

Web: www.bokerusa.com

Monday – Friday, 8:00am-4:30pm (MST)

Deliver to: CURRENT RESIDENT -or-

Open in style.

1
Boker Rose
Damascus Letter
Opener.
\$ 349.00

2
Boker Leopard
Damascus Letter
Opener.
\$ 209.00

1 BOKER ROSE BOKER DAMASCUS LETTER OPENER. This eye catching piece consists of 180 layers of powder metallurgical Damascus steel. The Damascus pattern "Wild Roses" complements this exquisite accessory, which also features a grind on both sides of the blade, creating beautiful lines and a perfect flow. The comfortable dimensions of the handle, with a lanyard hole and thumb serrations, allow a very well balanced feel in your hand. Opening letters has never been such a joy! Manufactured completely by hand at the Boker manufactory in Solingen, Germany. Comes in a premium leather pouch with

a certificate of authenticity. Serial numbered. Handle thickness: 3.5mm. Blade length: 3 $\frac{3}{8}$ ". Overall length: 6 $\frac{5}{8}$ ". Weight: 1.5 oz.
Item No. 140146DAM \$ 349.00

2 BOKER LEOPARD DAMASCUS LETTER OPENER. An exquisite masterpiece for the collector. The high performance Leopard Damascus steel is forged from the barrel of the battle tank Leopard I, exclusively for Boker. This extremely hard material is hand forged with tool steels and ball bearing steels to form 300 layers, which, through a special etching procedure are intricately defined in this Damascus pattern. The dynamic recurved tanto

style blade and the decorative file work on the back side mark the high standard of this extraordinary letter opener. Manufactured completely by hand at the Boker knife manufactory in Solingen, Germany. Includes a certificate of authenticity and a premium leather sleeve pouch. Serial numbered. Handle thickness: 4mm. Blade length: 4". Overall length: 6 $\frac{5}{8}$ ". Weight: 1.3 oz.
Item No. 140145DAM \$ 209.00

Intricate file work

Special etching process



BÖKER

MANUFAKTUR SOLINGEN

YOUR KNIFE