









	Index	Page
	Manual Motor Starters	1
	Auxiliary Contact Blocks	1
	Trip Alarm Auxiliary Switch	1
	Shunt Release	1
	Under-voltage Release	2
	Accessories	2
	Busbar Connectors	2
	Enclosures	2
	Technical Data	3
	Dimensions	4
	Tripping Characteristic	4

Manual Motor Starters

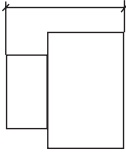
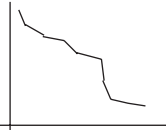

Thermal Overload Release Setting Range A	Ratings AC3 at		Magnetic short circuit trip A	Type	Pack pcs.	Weight kg/pc.
	400V kW	690V kW				
0,1 - 0,16	0,02	0,06	1,92	MU25A-0,16	2	0,25
0,16 - 0,25	0,06	0,12	3,0	MU25A-0,25	2	0,25
0,25 - 0,4	0,09	0,18	4,8	MU25A-0,4	2	0,25
0,4 - 0,63	0,12	0,25	7,6	MU25A-0,63	2	0,25
0,63 - 1	0,25	0,55	12,0	MU25A-1	2	0,25
1 - 1,6	0,55	1,1	19,2	MU25A-1,6	2	0,25
1,6 - 2,5	0,75	1,5	30	MU25A-2,5	2	0,25
2,5 - 4	1,5	3	48	MU25A-4	2	0,25
4 - 6,3	2,5	4	75,6	MU25A-6,3	2	0,25
6,3 - 10	4	7,5	120	MU25A-10	2	0,25
10 - 16	7,5	11	192	MU25A-16	2	0,25
16 - 20	9	12	240	MU25A-20	2	0,25
20 - 25	12,5	22	300	MU25A-25	2	0,25
25 - 32	15		384	MU25A-32	2	0,25

Auxiliary Contact Blocks, for side mounting, max. 2 pieces



Contacts			Rated Operational Current			Type	Pack pcs.	Weight kg/pc.
NO	NC	EM ¹⁾	AC15 230V A	400V A	AC1 500V A			
1	-	-	3,5	2	6	MU25A-PS10	10	0,03
-	1	-	3,5	2	6	MU25A-PS01	10	0,03
2	-	-	3,5	2	6	MU25A-PS20	10	0,03
1	1	-	3,5	2	6	MU25A-PS11	10	0,03
-	2	-	3,5	2	6	MU25A-PS02	10	0,03
-	1	1	3,5	2	6	MU25A-PV11	10	0,03
-	-	2	3,5	2	6	MU25A-PV20	10	0,03

Transverse Auxiliary Contact Block, max. 1 piece



Contacts			Rated Operational Current		Type	Pack pcs.	Weight kg/pc.
NO	NC	EM ¹⁾	AC15 230V A	AC1 230V A			
1	1	-	1	5	MU25A-PA11	10	0,02

Auxiliary Contact Blocks for mounting under the cover, max. 1 piece



Contacts			Rated Operational Current			Type	Pack pcs.	Weight kg/pc.
NO	NC	EM ¹⁾	AC15 230V A	400V A	AC1 500V A			
1	1	-	3,5	2	6	MU25A-PE11	10	0,02

Trip Alarm Auxiliary Switch for mounting under the cover, max. 1 piece



Contacts			Rated Operational Current			Type	Pack pcs.	Weight kg/pc.
NO	NC	EM ¹⁾	AC15 230V A	400V A	AC1 500V A			
1	-	-	3,5	2	6	MU25A-PM10	10	0,02
-	1	-	3,5	2	6	MU25A-PM01	10	0,02

1) early make

Shunt Release for mounting under the cover



Rated Control Voltage and Frequency V	Power Consumption		Type	Pack pcs.	Weight kg/pc.
	VA	W			
24V 50/60Hz	2,7	1,8	MU25A-A24	10	0,06
110V 50Hz, 110-120V 60Hz	2,7	1,8	MU25A-A110	10	0,06
220-230V 50Hz, 240V 60Hz	2,7	1,8	MU25A-A230	10	0,06
380-415V 50Hz, 440V 60Hz	2,7	1,8	MU25A-A400	10	0,06

Under-voltage Release for mounting under the cover



Rated Control Voltage and Frequency V	Power Consumption		Type	Pack pcs.	Weight kg/pc.
	VA	W			
24V 50/60Hz	2,7	1,8	MU25A-U24	10	0,06
110V 50Hz, 110-120V 60Hz	2,7	1,8	MU25A-U110	10	0,06
220-230V 50Hz, 240V 60Hz	2,7	1,8	MU25A-U230	10	0,06
380-415V 50Hz, 440V 60Hz	2,7	1,8	MU25A-U400	10	0,06

Accessories



Description	Specification	Type	Pack pcs.	Weight kg/pc.
Busbar Connector Fully Isolated, U_i 690V, I_u 63A				
Busbar	For 2 units 3-pole, 99mm long	MU25A-D99	10	0,036
Busbar	For 3 units 3-pole, 154mm long	MU25A-D154	10	0,060
Busbar	For 4 units 3-pole, 208mm long	MU25A-D208	10	0,084
Busbar	For 5 units 3-pole, 262mm long	MU25A-D262	10	0,107
Supply Block Protection Cover	3-pole for use with busbar connector for unused busbar terminations	MU25A-DB MU25A-BS	10 10	0,034 0,003
Spacing piece ½TE	for ambient temperature >40°C	P730	10	0,013
Current Limiter	For increasing the fault breaking capacity of single unit or group back-up to 50kA at 3~415V, above setting range 6,3-10A $U_i = 690V$, $I_u = 32A$	MU25A-ID50	1	0,172
Starter Carrier	For snap-on mounting contactor and manual motor starter on 35mm DIN-rail acc. DIN EN 50022	MU25A-PL54	1	0,06



Enclosures				
Moulded Enclosure	Protection to IP55	MU25A-O55	1	0,24
Moulded Front Plate	Protection to IP55	MU25A-C55	1	0,16
Locking Bracket	Suitable for 3 padlocks in "OFF"-position, stirrup diameter of the padlock max. 8 mm	MU25A-Z	1	0,10



Stop Button	Mushroom head	MU25A-NAT	1	0,04
Emergency Stop Button	latch, release by turning	MU25A-NAV	1	0,04
Emergency Stop Button	latch, release by key	MU25A-NAS	1	0,04



Indicator	green, for 220-240V~/=	MU25A-SG230	10	0,01
Indicator	red, for 220-240V~/=	MU25A-SR230	10	0,01
Indicator	white, for 220-240V~/=	MU25A-SW230	10	0,01

Indicator	green, for 380-440V~/=	MU25A-SG400	10	0,01
Indicator	red, for 380-440V~/=	MU25A-SR400	10	0,01
Indicator	white, for 380-440V~/=	MU25A-SW400	10	0,01



Neutral Conductor Block	for mounting in enclosure and front plate Wiring cross section 0,75 - 2,5mm ²	MU25A-NL	10	0,01
-------------------------	--	-----------------	----	------

Moulded Enclosure for 5-pole CEE-plug	Protection to IP54 with phase changing	MU25A-GC1	1	0,40
--	---	------------------	---	------

Manual Motor Starters

Data according to IEC 947, IEC 204, EN 60947, EN 60204, VDE 0660, VDE 0113

Type			MU25A			
Main Contacts						
Rated insulation voltage U_i	V~ ¹⁾		690			
Rated operational current I_e (= I_{th}) open, at 50°C	A		25			
Mechanical life						
Contact life at I_e /AC3	S x 10 ⁶		0,1			
	S x 10 ⁶		0,1			
Tripping class according to IEC 60947-4-1			10A			
Rated ultimate short-circuit breaking capacity I_{cu}			220-240V AC	380-415V AC	500V AC	660-690V AC
Values for open unit, when incoming supply on upper terminals						
Setting range	to 1A	kA	100	100	100	100
	1 - 1,6A	kA	100	100	100	100
	1,6 - 2,5A	kA	100	100	3	2,5
	2,5 - 4A	kA	100	100	3	2,5
	4 - 6,3A	kA	100	100	3	2,5
	6,3 - 10A	kA	100	6/50 ²⁾	3	2,5
	10 - 16A	kA	10/100 ²⁾	6/50 ²⁾	2,5	2
	16 - 20A	kA	10/100 ²⁾	6/50 ²⁾	2,5	2
	20 - 25A	kA	10/100 ²⁾	6/50 ²⁾	2,5	2
	25 - 32A	kA	10/100 ²⁾	6/50 ²⁾	2,5	2
Short circuit protection			220-240V AC	380-415V AC	500V AC	660-690V AC
Setting range	to 1A	A	-	-	-	-
	1 - 1,6A	A	-	-	-	-
Fuse gL(gG) only necessary if the short circuit current could be greater than the rated ultimate short-circuit breaking capacity	1,6 - 2,5A	A	-	-	25	20
	2,5 - 4A	A	-	-	35	25
	4 - 6,3A	A	-	-	50	35
	6,3 - 10A	A	-	80	50	35
	10 - 16A	A	80	80	63	35
	16 - 20A	A	80	80	63	50
	20 - 25A	A	80	80	63	50
	25 - 32A	A	80	80	63	50
Maximum ambient temperature						
Operation	open	°C	-25 to +55			
	enclosed	°C	-25 to +40			
Temperature compensation		°C	-20 to +55			
Power loss						
at rated current, warm condition		W	6 - 8			
Auxiliary Contacts						
Rated insulation voltage U_i	V~		500			
Thermal rated current I_{th}	Ambient temperature max. 50°C	A	6			
Utilization category AC15						
Rated operational current I_e	220-240V	A	3,5			
	380-415V	A	2			
	500V	A	1			
Short circuit protection						
max. fuse size	gL (gG)	A	6			
Cable cross-section						
Main connector	solid or stranded	mm ²	0,75 - 4			
	flexible	mm ²	0,75 - 2,5			
	flexible with multicore cable end	mm ²	0,75 - 2,5			
Cables per clamp			2			
Auxiliary connector	solid or stranded	mm ²	0,75 - 2,5			
	flexible	mm ²	0,75 - 1,5			
	flexible with multicore cable end	mm ²	0,75 - 1,5			
Cables per clamp			2			
Resistance to shock according to IEC 68-2-27						
Operation		g / ms	4 / 11			
Solidity		g / ms	30 / 18			

1) Suitable for: earthed-neutral systems, overvoltage category I to III, pollution degree 3 (standard-industry): Uimp = 6kV.

2) with current limiter MBS25-ID50 up to 415V AC

Manual Motor Starters

Dimensions

Manual Motor Starter MU25A

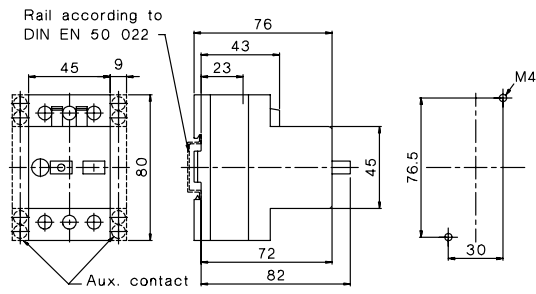

Moulded Enclosure MU25A-O55

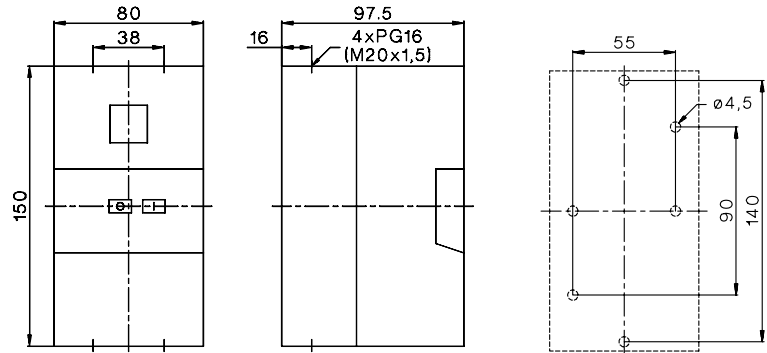

Moulded Front Plate MU25A-C55

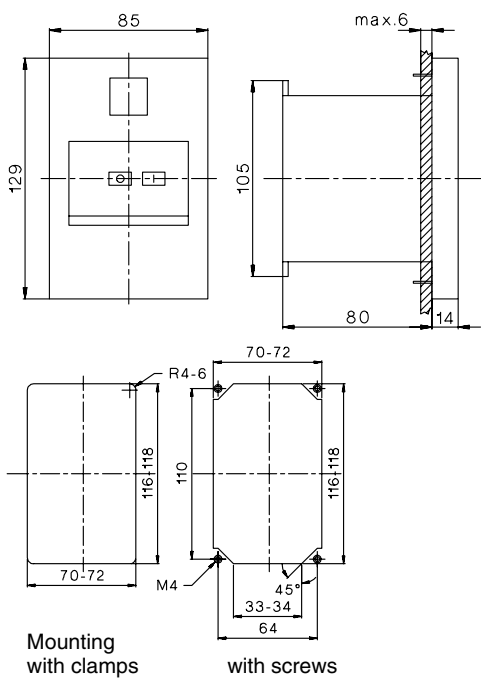

Moulded Enclosure for 5-pole CEE-plug MU25A-GC1

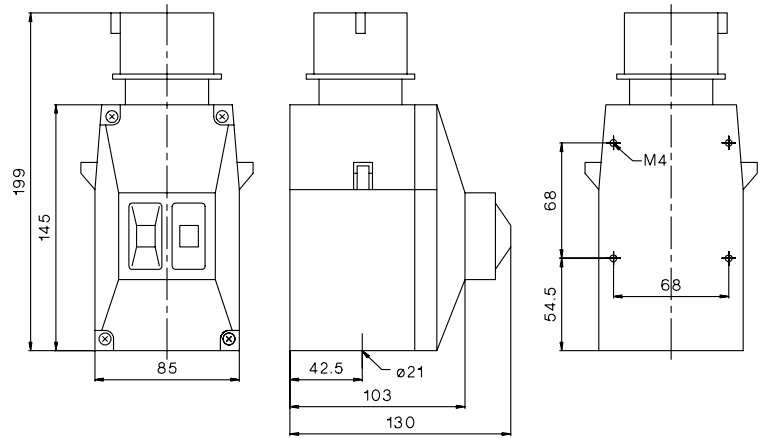

Temperature Compensation

In case of higher ambient temperature use the following formula:
 $(\text{Ambient temperature} - 20) \times 0,3 = \text{correction factor in \% of the full load motor current}$

Example: Ambient temperature 60°C, full load motor current 5A
 $(60 - 20) \times 0,3 = 12\%$
 Setting value: $5A + 12\% = 5,6A$

Tripping Characteristic

0,16 - 16A

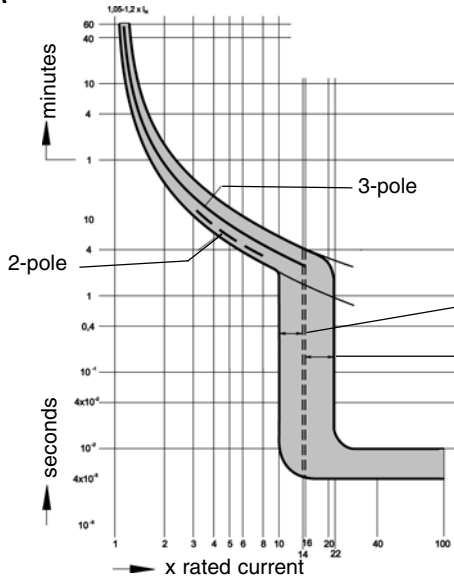

16 - 32A

