

# Pro-Grade®

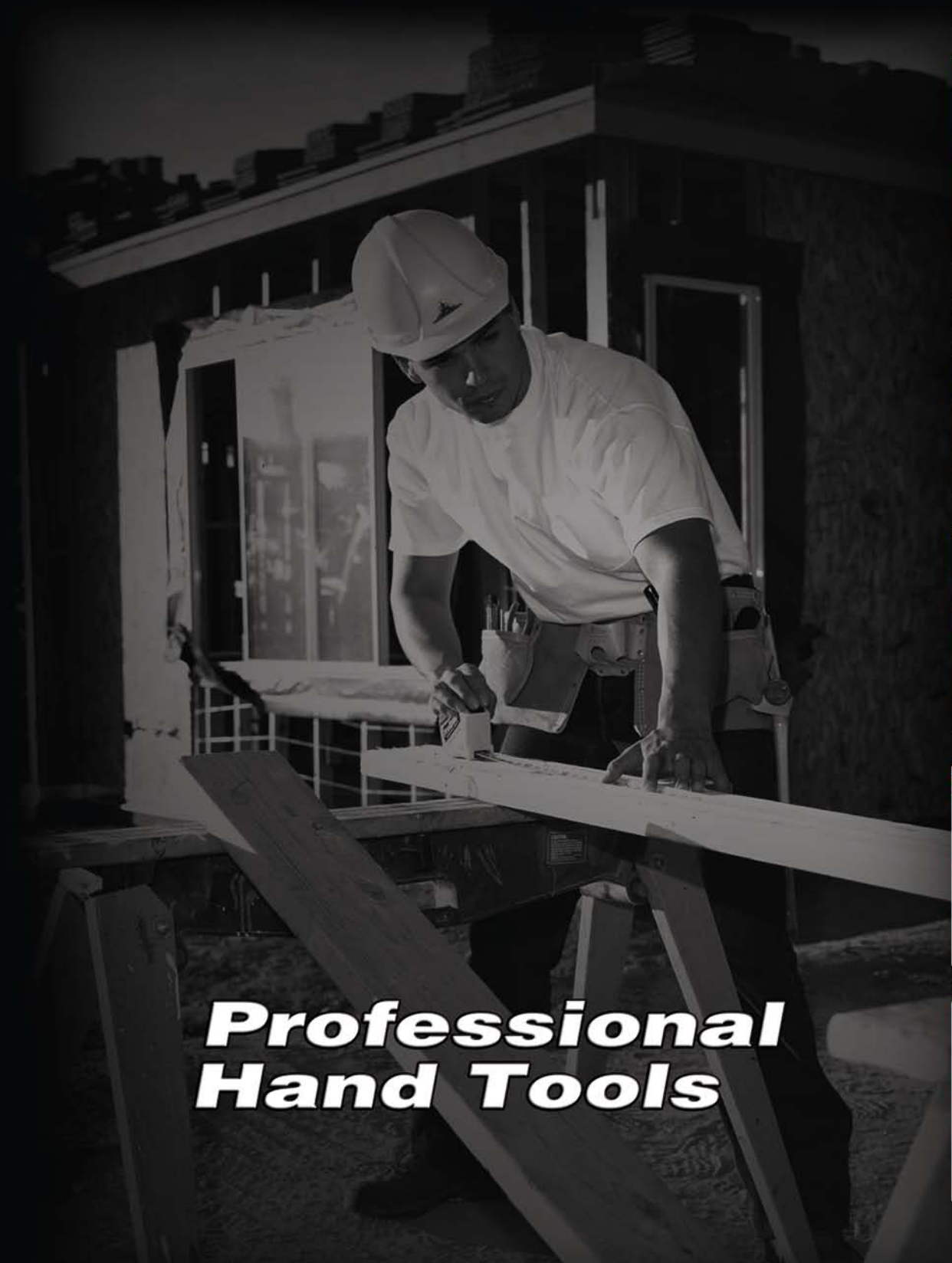
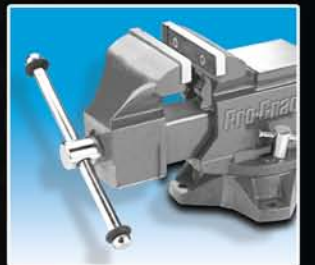

## Professional Hand Tools

### Pro-Grade®

DIVISION OF ALLIED INTERNATIONAL

13207 Bradley Avenue · Sylmar, CA 91342

(800) 248-6657 · Fax (818) 362-9066 · [www.alliedtools.com](http://www.alliedtools.com)



## Designed to Perform...Built to Last

Pro-Grade® products are designed and built with one goal in mind - to equip your customer with the best value available in Professional Quality Hand Tools.



To ensure long-lasting durability and performance, we start by using only premium quality raw materials like Chrome Vanadium Alloy, Chrome Nickel and High Carbon Tool Steel. When employ the latest in design innovation and ergonomic styling because a professional quality hand tool should not only work hard, it should look good doing it.



Precise manufacturing techniques and strict quality control are then added so that every product will meet or exceed A.N.S.I. (American National Standards Institute) or U.S. Federal Specifications for quality and performance. In fact, we're so sure of our product's quality, every item is backed up by an Unconditional Replacement Warranty for the life of the tool.



The net result is quite simple...a professional quality tool your customers will be proud to own at a price they can afford.

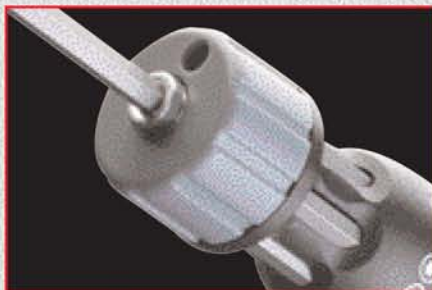

### ALLIED CUSTOMER SERVICE LINE

**1-800-248-6657**

HOURS - 7:00 AM to 3:00 PM Pacific Standard Time  
Monday through Friday



## CUTTING TOOLS

Hand Saws, Snips, Utility Knives, Replacement Blades

**4-11**

## LAYOUT TOOLS

Tape Measures, Tape Reels, Plumb Bob, Chalk Line

**12-13**

## STRIKING & STRUCK TOOLS

Nail, Dead Blow and Ball Pein Hammers, Nail Sets

**14-15**

## VICES & CLAMPS

Vises, Spring Clamps, C-Clamps, Bar Clamps, Specialty Clamps

**16-19**

## FINISHING TOOLS

Shaver, Files, Planes

**20**

## PRECISION TOOLS

Hobby Knives and Kits, Blades, Specialty Tools

**21-22**

## WRENCHES

Adjustable Wrenches, Pipe Wrenches

**23**

## DRIVING TOOLS

Screwdrivers, Folding Driver Sets, Ratcheting Drivers

**24-26**

## PLIERS & CUTTERS

Loose and Fixed Joint Pliers, Locking Pliers, Bolt Cutters

**27**

## INDEX

By part number with description

**28-31**



On-Board Blade Storage

82026

### Fastback™ Folding Utility Knife

- Safety lock button locks in open and closed positions
- Lightweight aluminum body with comfortable non-slip grip
- On-board blade storage includes 2 spare blades

ITEM NO.	DESCRIPTION	PACKAGE	SHIP QTY	CASE QTY
82061	Fastback™ Folding Utility Knife	Card	4	24



82070

### Bullet Blade™

- Dual blade utility cutter
- Places hand, forearm, and wrist in neutral position
- Reduces fatigue and optimizes cutting performance

ITEM NO.	DESCRIPTION	PACKAGE	SHIP QTY	CASE QTY
82070	Bullet Blade™	Card	6	24



On-Board Blade Storage

82069

### Fastback™ Utility Knife

- Heavy duty die cast zinc body
- Push button blade release for quick blade change
- Spring loaded quick deploy blade chamber
- Includes 5 high quality blades

ITEM NO.	DESCRIPTION	PACKAGE	SHIP QTY	CASE QTY
82069	Fastback™ Utility Knife	Card	6	24



82067

### XLBlade™ Utility Knife

- Stores and re-loads blades automatically
- Push button blade release for quick blade change
- Comfortable ergonomic design with non-slip rubber grip
- Includes 8 high quality blades

ITEM NO.	DESCRIPTION	PACKAGE	SHIP QTY	CASE QTY
82067	XLBlade™ AutoLoading Utility Knife	Card	6	48
82067CD	XLBlade™ AutoLoading Utility Knife in CD	Card	12	48



82061

### Pro-Grip Utility Knife

- Heavy duty die cast zinc body
- Non-slip rubber grip for increased safety
- Blade change requires no tools

ITEM NO.	DESCRIPTION	PACKAGE	SHIP QTY	CASE QTY
82061	Pro-Grip Heavy Duty Utility Knife	Card	6	48

### Self Retracting Utility Knife

- Heavy duty die cast zinc body
- Spring loaded, automatic blade return
- Safe over / under blade guide

ITEM NO.	DESCRIPTION	PACKAGE	SHIP QTY	CASE QTY
82066	Self Retracting Utility Knife	Card	6	48



82066

### Heavy Duty Utility Knife

- Heavy duty die cast zinc body
- Ergonomically shaped handle for comfort and control
- Blade change requires no tools

ITEM NO.	DESCRIPTION	PACKAGE	SHIP QTY	CASE QTY
82063	Quick Change Utility Knife	Card	6	36



82063

### Retractable Utility Knife

- Four position retractable blade
- Durable die cast metal body

ITEM NO.	DESCRIPTION	PACKAGE	SHIP QTY	CASE QTY
82081	Retractable Utility Knife	Card	6	120



82081

### Fixed Blade Utility Knife

- Blades store securely in handle
- Durable die cast zinc body

ITEM NO.	DESCRIPTION	PACKAGE	SHIP QTY	CASE QTY
82087	Fixed Blade Utility Knife - Zinc	Card	6	72



82087

### Mini Key Chain Knife

- Blade retracts for safety
- Die cast metal body with convenient key chain

ITEM NO.	DESCRIPTION	PACKAGE	SHIP QTY	CASE QTY
82076	Key Chain Utility Knife	Card	6	144
82077	Key Chain Utility Knife Blades	Card	12	240

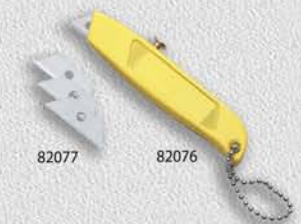

82077

82076



## Snap Knife

- Snap-off blade for continuous sharp edge
- Non-slip rubber grip for safety and comfort
- Auto loading blade chamber

ITEM NO.	DESCRIPTION	PACKAGE	SHIP QTY	CASE QTY
82083	9mm Snap Knife	Card	6	144
82084	18mm Snap Knife	Card	6	72
82085	9mm Snap Knife Blades, 3 Pack	Card	12	144
82086	18mm Snap Knife Blades, 3 Pack	Card	12	144

## Carpet Knife

- Blade change requires no tools
- Lightweight handle for comfort and control
- Blades store in handle



ITEM NO.	DESCRIPTION	PACKAGE	SHIP QTY	CASE QTY
82091	Carpet Utility Knife with 3 Blades	Card	6	72
82092	5 Pc. Carpet Knife Blades	Card	12	240

## Linoleum Knife

- Stainless steel long point blade
- Makes accurate and even cuts without burns
- Comfortable contoured grip



ITEM NO.	DESCRIPTION	PACKAGE	SHIP QTY	CASE QTY
82090	Linoleum Utility Knife with Plastic Handle	Card	6	72

## Glass Cutter

- Heat-treated steel cutting wheel
- Cast iron handle with ball end for tapping
- Cuts plate glass up to 1/4"



ITEM NO.	DESCRIPTION	PACKAGE	SHIP QTY	CASE QTY
82075	Glass Cutter	Card	24	240

## Pocket Knife

- Blade locks into position for safety
- Extra blade storage in handle
- Ideal for fine work, models and crafts



ITEM NO.	DESCRIPTION	PACKAGE	SHIP QTY	CASE QTY
82078	Locking Pocket Knife	Card	6	120
82079	Pocket Knife Sheepfoot Blades	Card	12	240
82080	Pocket Knife Utility Blades	Card	12	240

## Safety Scraper

- Blade retracts for safe storage
- Removes glue, paint, putty and other adhesives from smooth surfaces
- Uses standard single edge razor blades

ITEM NO.	DESCRIPTION	PACKAGE	SHIP QTY	CASE QTY
82093	Razor Blade Scraper with 5 Blades	Card	6	144
82094	10 Pc. Single Edge Razor Blades	Card	12	240
82095	100 Pc. Single Edge Razor Blades	Card	6	48



## Window Scraper

- Scrapes paint, putty, tiles, mirrors and other flat surfaces
- Blade guard also acts as a scraper
- Accepts standard utility knife blades

ITEM NO.	DESCRIPTION	PACKAGE	SHIP QTY	CASE QTY
82096	Window Scraper	Card	6	120



## Replacement Blades

- High grade SK2 steel blade
- Fits standard size utility knives

ITEM NO.	DESCRIPTION	PACKAGE	SHIP QTY	CASE QTY
82062	100 Pc. Utility Knife Blade Pack with Dispenser	Card	6	36
82073	5 Pc. Utility Knife Blades	Card	12	240
82097	5 Pc. Small Hook Utility Knife Blades	Card	12	240
82098	5 Pc. Large Hook Utility Knife Blades	Card	12	240



## Aviation Tin Snips

- Durable chrome molybdenum jaws
- Spring loaded compound cutting action
- Swivel lock

ITEM NO.	DESCRIPTION	PACKAGE	SHIP QTY	CASE QTY
31680	Aviation Tin Snips Left - Red	Card	4	24
31681	Aviation Tin Snips Straight - Yellow	Card	4	24
31682	Aviation Tin Snips Right - Green	Card	4	24





Aggressive Tri-Bevel Tooth Design 31973

## Aggressive Tooth Hand Saws

- Aggressive tooth design cuts fast through wood or plastic
- Induction hardened teeth stay sharp up to 5 times longer than standard teeth
- Ergonomic molded rubber grip for control and comfort

ITEM NO.	DESCRIPTION	PACKAGE	SHIP QTY	CASE QTY
31973	15" / 9 Pt. Tool Box Saw	Sleeve	4	24
31974	20" / 12 Pt. Hand Saw	Sleeve	4	24



31978

## Hand Saw

- Precision ground heat treated teeth stay sharp up to 5 times longer than standard teeth
- Hardened and tempered steel blade for strength and durability

ITEM NO.	DESCRIPTION	PACKAGE	SHIP QTY	CASE QTY
31978	20" / 8 Pt. Hand Saw	Sleeve	4	24



31971

## All Purpose Hand Saws

- Precision ground induction hardened teeth stay sharp up to 5 times longer than standard teeth
- Hardened and tempered steel blade for strength and durability
- Ergonomic hardwood handle

ITEM NO.	DESCRIPTION	PACKAGE	SHIP QTY	CASE QTY
31970	15" / 12 Pt. Tool Box Saw	Sleeve	4	24
31971	20" / 10 Pt. Hand Saw	Sleeve	4	24
31972	26" / 8 Pt. General Purpose Saw	Sleeve	4	24



Aggressive Tri-Bevel Tooth Design 31969

## Drywall Saw

- Aggressive tooth design cuts fast through wood or plastic
- Heat-treated teeth stay sharp up to 5 times longer than standard teeth
- Ergonomic hardwood handle

ITEM NO.	DESCRIPTION	PACKAGE	SHIP QTY	CASE QTY
31969	15" / 9 Pt. Drywall Saw	Sleeve	4	24



31968

## Miter Back Saw

- Precision ground, heat treated teeth stay sharp up to 5 times longer than standard teeth
- Hardened and tempered steel blade for strength and durability
- Ergonomic hardwood handle

ITEM NO.	DESCRIPTION	PACKAGE	SHIP QTY	CASE QTY
31968	14" / 12 Pt. Miter Back Saw	Sleeve	6	24

## Compass Saw

- 6 Position adjustable blade for cutting at any angle
- Precision ground, heat treated teeth stay sharp up to 5 times longer than standard teeth
- Comfortable non-slip rubber grip

ITEM NO.	DESCRIPTION	PACKAGE	SHIP QTY	CASE QTY
31967	12" / 8 Pt. Compass Saw	Sleeve	6	24



31967

## Coping Saws

- Carbon steel frame with comfortable hardwood handle
- Heat treated blade stays sharp longer than traditional blades
- Blade can be turned 360° for cutting at any angle

ITEM NO.	DESCRIPTION	PACKAGE	SHIP QTY	CASE QTY
31964	4 3/4" Coping Saw	Sleeve	6	24
31963	6 3/4" Coping Saw	Sleeve	6	24
31962	5 Pc. Coping Saw Blades	Card	6	48



31964

## Reversing Back Saw

- Reversible offset handle for flush cuts and left or right hand use
- Designed to cut a straight, smooth and narrow kerf
- Comfortable hardwood handles for positive control
- Induction heat treated blade for extra strength and durability

ITEM NO.	DESCRIPTION	PACKAGE	SHIP QTY	CASE QTY
31966	10" / 13 Pt. Reversing Back Saw	Sleeve	6	24



31966

## Dovetail Saw

- Designed to cut a straight, smooth and narrow kerf
- Comfortable hardwood handle for positive control
- Induction heat treated blade for extra strength and durability

ITEM NO.	DESCRIPTION	PACKAGE	SHIP QTY	CASE QTY
31965	10" / 15 Pt. Dovetail Saw	Sleeve	6	24



31965

## Mitre Box

- For making fixed 90°, 45°, and 22.5° cuts, and 45° face cuts
- Convenient metric and SAE horizontal measurements
- Made of durable high impact ABS plastic

ITEM NO.	DESCRIPTION	PACKAGE	SHIP QTY	CASE QTY
39955	Mitre Box	Sleeve	2	12

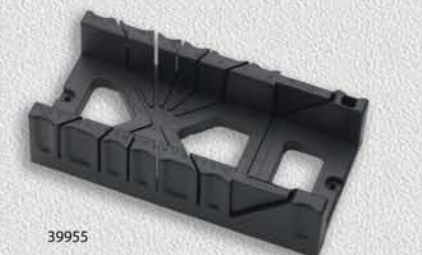

39955



31912

### High Tension Hacksaw

- Heavy duty construction for stability and strength
- Comfortable dual non-slip rubber grip
- 3 Blade settings - 90°, 45° and compass saw

ITEM NO.	DESCRIPTION	PACKAGE	SHIP QTY	CASE QTY
31912	High Tension Hacksaw	Sleeve	4	24

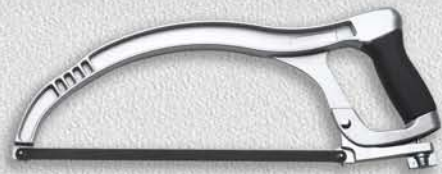

31975

### High Tension Aluminum Frame Hacksaw

- Low profile design for tight areas
- Sturdy I-Beam construction for stability and strength
- Lightweight aluminum frame with non-slip rubber grip

ITEM NO.	DESCRIPTION	PACKAGE	SHIP QTY	CASE QTY
31975	High Tension Aluminum Frame Hacksaw	Sleeve	4	24



31977

### Adjustable Frame Hacksaw

- Heavy duty steel frame fits 8", 10", and 12" blades
- Wing nut adjustable tension and 90° or 180°
- Fully enclosed handle with two material non-slip grip

ITEM NO.	DESCRIPTION	PACKAGE	SHIP QTY	CASE QTY
31977	High Tension Hacksaw	Sleeve	4	24



31913

### Bow Saw / Hacksaw

- Two saws in one: bow saw for wood, hacksaw for metal and plastic
- Sturdy tubular steel construction

ITEM NO.	DESCRIPTION	PACKAGE	SHIP QTY	CASE QTY
31913	Bow Saw / Hacksaw	Sleeve	4	12
31915	2 Pc. Bow Saw Replacement Blades	Card	12	144



31910

### Mini Hack / Coping Saw

- Sturdy I-Beam construction for stability and strength
- 6 Blade angle settings for cutting at any angle
- Ideal for cutting wood, metal and plastic

ITEM NO.	DESCRIPTION	PACKAGE	SHIP QTY	CASE QTY
31910	Mini Hack / Coping Saw	Sleeve	6	24
31910TR	Mini Hack / Coping Saw in TR	Sleeve	24	24
31911	5 Pc. Mini Hack / Coping Saw Blades	Card	6	24

### Utility Hacksaw

- Impact resistant ABS handle with comfortable cushion grip
- Adjustable blade length

ITEM NO.	DESCRIPTION	PACKAGE	SHIP QTY	CASE QTY
31916	Utility Hacksaw	Card	6	48



31916

### Jab Saw

- Accepts hacksaw or reciprocating saw blades
- Adjustable blade length
- Comfortable molded cushion grip

ITEM NO.	DESCRIPTION	PACKAGE	SHIP QTY	CASE QTY
31917	Jab Saw	Card	6	48



31917

### Keyhole Saw

- Aggressive tri-bevel tooth design cuts fast through wood and plastic
- Wider blade with sharpened point for plunge cuts
- Comfortable molded rubber grip

ITEM NO.	DESCRIPTION	PACKAGE	SHIP QTY	CASE QTY
31922	Aggressive Tooth Keyhole Saw	Card	6	48



31922

Aggressive Tri-Bevel Tooth Design



### Wallboard Saw

- Ergonomic cushion grip with 24" lanyard
- Tempered steel blade

ITEM NO.	DESCRIPTION	PACKAGE	SHIP QTY	CASE QTY
31918	Wallboard Saw	Card	6	48



31918

### Hacksaw Blades

- Cuts mild steel, cast iron, aluminum, copper etc.

ITEM NO.	DESCRIPTION	PACKAGE	SHIP QTY	CASE QTY
31956	10" / 18 TPI Hacksaw Blade - Carbon Steel	Card	10	100
31955	10" / 24 TPI Hacksaw Blade - Carbon Steel	Card	10	100
31957	12" / 18 TPI Hacksaw Blade - Carbon Steel	Card	10	100
31959	12" / 24 TPI Hacksaw Blade - Carbon Steel	Card	10	100
31958	12" / 32 TPI Hacksaw Blade - Carbon Steel	Card	10	100
31961	12" / 24 TPI Hacksaw Blade - Bi-Metal	Card	10	100
31960	12" / 32 TPI Hacksaw Blade - Bi-Metal	Card	10	100

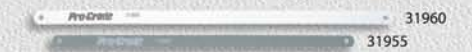

31960

31955



42813

## Magnum™ Wide Blade Tape Measures

- Extra wide blade for true 10' stand out
- Dual ball bearings provide smooth action\*
- Comfortable compact case with molded grip

ITEM NO.	DESCRIPTION	PACKAGE	SHIP QTY	CASE QTY
42813*	1-5/8" x 25' Magnum™ Tape Measure	Card	4	24
42815	1-5/16" x 25' Magnum™ Tape Measure	Card	6	24



42811

## XLRule™ Nylon Coated Tape Measure

- 1-3/16" wide blade for extra stand out
- Pro-Stop blade brake for smooth controlled blade return
- 1/4", 1/8" and 1/16" fractional read-outs

ITEM NO.	DESCRIPTION	PACKAGE	SHIP QTY	CASE QTY
42811	1-3/16" x 25' XLRule™ Tape Measure	Card	6	24
42812	1-3/16" x 30' XLRule™ Tape Measure	Card	6	24



82826

## Powerule™ Tape Measures

- Pro-Stop blade brake for smooth controlled blade return
- Comfortable non-slip rubber palm grip
- Easy use rocking thumb lock

ITEM NO.	DESCRIPTION	PACKAGE	SHIP QTY	CASE QTY
82821	3/4" x 16' Powerule™ Tape Measure	Card	6	24
82819CD	1" x 25' Powerule™ Tape Measure in CD	Bulk	12	12
82819TR	1" x 25' Powerule™ Tape Measure in TR	Bulk	32	32
82826	1" x 25' Powerule™ Tape Measure	Card	6	24
82822	1" x 30' Powerule™ Tape Measure	Card	6	24



82884

## Tech Tape™

- Rust resistant stainless steel housing
- Nylon coated blade for extended life
- Fractional read-outs in 1/8" increments

ITEM NO.	DESCRIPTION	PACKAGE	SHIP QTY	CASE QTY
82884	1" x 25' Tech Tape™	Card	6	48



42807

## Auto-Locking Tape Measures

- Fractional read-outs in 1/8" increments
- Auto engaging blade lock

ITEM NO.	DESCRIPTION	PACKAGE	SHIP QTY	CASE QTY
42807	1" x 25' AutoLocking Tape Measure	Card	6	24
42808	1" x 30' AutoLocking Tape Measure	Card	6	24

## Chrome Tape Measures

- High impact chrome plated ABS case
- Fractional read-outs in 1/8" increments

ITEM NO.	DESCRIPTION	PACKAGE	SHIP QTY	CASE QTY
42800	1/4" x 10' Tape Measure	Card	6	48
42801	1/2" x 12' Tape Measure	Card	6	48
42802	3/4" x 16' Tape Measure	Card	6	24
42803	1" x 25' Tape Measure	Card	6	24
42804	1" x 30' Tape Measure	Card	6	24
42805	1" x 35' Tape Measure	Card	6	24



42803

## Long Blade Tape Measure

- High impact ABS case with comfortable rubber grip
- Steel roller and guide prevent blade from cutting case
- Tempered high carbon steel blade with poly coating

ITEM NO.	DESCRIPTION	PACKAGE	SHIP QTY	CASE QTY
42810	3/8" x 100' Steel Tape Measure	Card	4	24



42810

## SpeedReel™ Tape Measure

- Rewinds 3x faster than conventional reel tapes
- Plastic coated fiberglass tape
- Comfortable non-slip rubber grip

ITEM NO.	DESCRIPTION	PACKAGE	SHIP QTY	CASE QTY
82823	1/2" x 100' SpeedReel™ Tape Measure	Card	4	24



82823

## 100 ft. SpeedReel™ Chalk Line

- 3.5:1 Gear ratio for quick rewind
- Push button line release
- Rubberized impact resistant ABS case
- Quick, one finger pressure release for one hand use

ITEM NO.	DESCRIPTION	PACKAGE	SHIP QTY	CASE QTY
82850	100 ft. SpeedReel™ Chalk Line	Blister	6	24
82849	Chalk Refill - Blue	Label	6	24



82850

82849

## Plumb Bob

- Screw top for easy line attachment
- Rust resistant polished brass construction
- Replaceable hardened steel tip
- Thru-hole on tip for easy tightening

ITEM NO.	DESCRIPTION	PACKAGE	SHIP QTY	CASE QTY
82848	4 oz. Brass Plumb Bob	Card	6	36



82848

## Solid Steel Hammers

- Molded grip increases comfort and reduces fatigue
- Induction hardened face and claw for strength and durability
- Magnetic nail holder for starting nails in hard to reach places

ITEM NO.	DESCRIPTION	PACKAGE	SHIP QTY	CASE QTY
61341	16 oz. Claw Hammer	Half Clam	4	24
61342	16 oz. Rip Hammer	Half Clam	4	24
61343	20 oz. Claw Hammer	Half Clam	4	24
61344	20 oz. Rip Hammer	Half Clam	4	24
61346	22 oz. Framing Hammer - Milled Face	Half Clam	4	24
61347	28 oz. Framing Hammer- Milled Face	Half Clam	4	24



Magnetic Nail Holder 61341

## Jacketed Fiberglass Handle Hammers

- Induction hardened face and claw for strength and durability
- Jacketed fiberglass handle for overstrike protection
- Magnetic nail holder for starting nails in hard to reach places

ITEM NO.	DESCRIPTION	PACKAGE	SHIP QTY	CASE QTY
61339	16 oz. Claw Hammer	Label	4	24
61340	16 oz. Rip Hammer	Label	4	24
31358	20 oz. Rip Framing Hammer	Label	4	24



31358

## Hickory Handle Hammers

- Induction hardened face and claw for strength and durability
- American hickory handle
- Magnetic nail holder for starting nails in hard to reach places

ITEM NO.	DESCRIPTION	PACKAGE	SHIP QTY	CASE QTY
61334	13 oz. Claw Hammer	Label	4	24
61335	16 oz. Claw Hammer	Label	4	24
61336	16 oz. Rip Hammer	Label	4	24
61377	25 oz. Framing Hammer- Milled Face	Label	4	24



61377

## Dead Blow Hammers

- High visibility, non-sparking, non-marring PVC
- Steel reinforced handle with no exposed metal
- Carbon steel shot fill

ITEM NO.	DESCRIPTION	PACKAGE	SHIP QTY	CASE QTY
61372	1 lb. Dead Blow Hammer	Label	4	24
61373	2 lb. Dead Blow Hammer	Label	4	24
61374	3 lb. Dead Blow Hammer	Label	4	24
61375	4 lb. Dead Blow Hammerr	Label	4	24



61375

## Ball Pein Hammers

- Forged high carbon steel head with polished striking head and pein
- Jacketed fiberglass handle with rubber grip

ITEM NO.	DESCRIPTION	PACKAGE	SHIP QTY	CASE QTY
15608	8 oz. Ball Pein Hammer	Label	6	48
15616	16 oz. Ball Pein Hammer	Label	6	36
15624	24 oz. Ball Pein Hammer	Label	6	24
15632	32 oz. Ball Pein Hammer	Label	6	24



15608

## Pry Bar

- Forged and heat treated carbon steel
- Polished and hardened claws

ITEM NO.	DESCRIPTION	PACKAGE	SHIP QTY	CASE QTY
61329	15" Flat Pry Bar	Label	6	36



61329

## Nail Sets & Punches

- Used for setting nails below surfaces and starting screw holes
- Hardened and tempered alloy steel

ITEM NO.	DESCRIPTION	PACKAGE	SHIP QTY	CASE QTY
61384	Self Centering Punch Screw Hole	Card	6	384
61385	1/32" Self Centering Nail Set	Card	6	384
61386	2/32" Self Centering Nail Set	Card	6	384
61387	3/32" Self Centering Nail Set	Card	6	384
61388	3 Pc. Nail Set - 1/32, 2/32, 3/32"	Card	6	144
61389	3 Pc. Nail Set - Color Coded	Card	6	144



63184

63188

63189

## Wood Chisels

- Fully hardened and tempered blades
- Strike plate on handle for use with mallets

ITEM NO.	DESCRIPTION	PACKAGE	SHIP QTY	CASE QTY
63026	1/4" Wood Chisel	Card	6	24
63027	1/2" Wood Chisel	Card	6	24
63028	3/4" Wood Chisel	Card	6	24
63029	1" Wood Chisel	Card	6	24
63030	1-1/4" Wood Chisel	Card	6	24
63031	1-1/2" Wood Chisel	Card	6	24
63032	4 Pc. Wood Chisel Set	Card	6	24



63029

63028

63027

63026



59124

### 3" Hobby Vise

- Lightweight aluminum with durable powder coat finish
- Head rotates 360° and tilts at 45° and 90° angles
- Clamp-on base with protective rubber pads
- Chrome plated spindle and hardware

ITEM NUMBER	DESCRIPTION	PACKAGE	SHIP QTY	CASE QTY
59124	3" Hobby Vise	Box	4	8



59109

### Workshop Vises

- Heavy duty 20,000-psi castings with durable powder coat finish
- Replaceable hardened steel jaws with permanent pipe jaws and polished anvil
- 270° locking swivel base\* with four reinforced anchor points
- Black oxide handle and spindle

ITEM NUMBER	DESCRIPTION	PACKAGE	SHIP QTY	CASE QTY
59109	3" Workshop Clamp Vise	Box	1	6
59110	4" Workshop Bench Vise	Box	1	2
59111	5" Workshop Bench Vise	Box	1	2
59112	6" Workshop Bench Vise	Box	1	1

\* Excludes 59109 Clamp Vise



59111



59114

### Mechanic's Bench Vises

- Heavy duty 30,000-psi castings with durable powder coat finish
- Replaceable hardened steel jaws with permanent pipe jaws and polished anvil
- 270° locking swivel base, with four reinforced anchor points
- Chrome plated handle and spindle with quick response jaw mechanism

ITEM NUMBER	DESCRIPTION	PACKAGE	SHIP QTY	CASE QTY
59113	3" Mechanic's Bench Vise	Box	1	2
59114	4" Mechanic's Bench Vise	Box	1	1
59115	5" Mechanic's Bench Vise	Box	1	1
59116	6" Mechanic's Bench Vise	Box	1	1

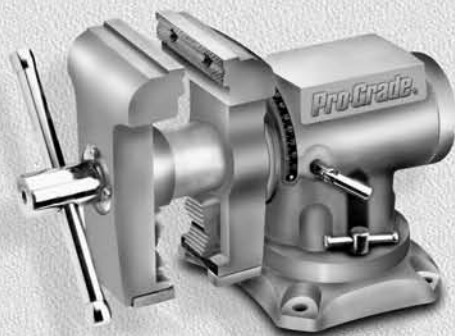

59118

### Multi Purpose Vises

- Versatile design provides 360° rotating jaws and base
- 2-1/2 ton holding capacity, reinforced 4-lug locking base and large polished anvil
- Precision calibration markings for setting and locking jaw angle
- Chrome plated handle and spindle with protective enclosed channel

ITEM NUMBER	DESCRIPTION	PACKAGE	SHIP QTY	CASE QTY
59118	5" Multi Purpose Mechanic's Vise	Box	1	1

### Drill Press Vise

- Specially designed for drill press applications such as drilling, tapping, milling and grinding
- Replaceable hardened steel jaw faces, with center aligning bar
- Durable powder coat finish and black oxide handle and spindle

ITEM NUMBER	DESCRIPTION	PACKAGE	SHIP QTY	CASE QTY
59120	4" Flat Drill Press Vise	Box	1	8
59121	3-1/2" Angle Drill Press Vise	Box	1	4



59120



59121

### Woodworking Vise

- Pre-drilled holes in jaws for attaching wood facings
- Continuous screw and steel guide bars for smooth operation
- Movable metal dog for clamping large pieces of wood
- Durable powder coat finish and black oxide handle and spindle

ITEM NUMBER	DESCRIPTION	PACKAGE	SHIP QTY	CASE QTY
59122	6-1/2" Woodworkers Vise	Box	1	10



59122

### C-Clamps

- Malleable iron frames and black oxide steel spindle
- Durable powder coat finish

ITEM NUMBER	DESCRIPTION	PACKAGE	SHIP QTY	CASE QTY
59128	1"x1" C-Clamp	Card	6	36
59129	1-1/2"x1-1/2" C-Clamp (deep throat)	Card	6	36
59130	2"x1" C-Clamp	Card	6	36
59131	2"x3-1/2" C-Clamp (deep throat)	Card	6	36
59132	2-1/2"x1-3/8" C-Clamp	Card	6	36
59133	2-1/2"x2-1/2" C-Clamp	Card	6	36
59134	3"x2" C-Clamp	Card	6	36
59135	3"x4-1/2" C-Clamp (deep throat)	Card	6	24
59136	4"x3" C-Clamp	Card	6	24
59137	5"x3-1/4" C-Clamp	Card	6	18
59138	6"x3-1/2" C-Clamp	Card	6	18
59139	8"x4" C-Clamp	Card	1	6
59163	2-1/2" 3-way C-Clamp	Card	6	18



59134



59163



59135

### Quick Release C-Clamps

- Quick release mechanism for fast opening and closing
- Heavy duty cast iron with hardened spindle and handle
- Durable powder coat finish and chrome plated hardware

ITEM NUMBER	DESCRIPTION	PACKAGE	SHIP QTY	CASE QTY
59141	4"x 2-1/4" Quick Release C-Clamp	Card	6	18
59142	5"x 2-1/2" Quick Release C-Clamp	Card	6	12
59143	6"x 3" Quick Release C-Clamp	Card	6	12



59143

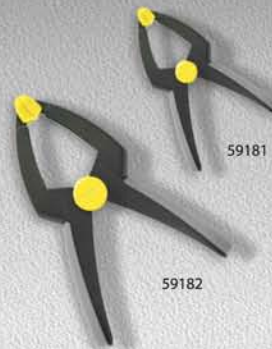

## Nylon Spring Clamps

- Durable nylon polymer construction
- Soft touch pivoting tips
- Comfortable molded rubber grips

ITEM NUMBER	DESCRIPTION	PACKAGE	SHIP QTY	CASE QTY
59180	mp	Card	6	36
59181		Card	6	36
59182		Card	6	18

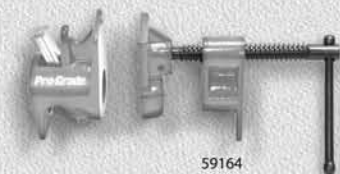

## Pipe Clamps

- Powder coated malleable steel body with wide base
- Secure hold clutch mechanism with quick release function
- Pvc pads help prevent marring of work surfaces\*

ITEM NUMBER	DESCRIPTION	PACKAGE	SHIP QTY	CASE QTY
59164	1/2" Pipe Clamp	Clam	4	12
59165	3/4" Pipe Clamp, with Pads*	Clam	4	12
59166	Pipe Clamp Pads, 2 Sets	Card	6	24



## Corner Clamps

- Die cast aluminum frame with black oxide steel spindles
- Holds pieces up to 3" thick, at a fixed 90° angle or any angle from 0° to 360°

ITEM NUMBER	DESCRIPTION	PACKAGE	SHIP QTY	CASE QTY
59161	Adjustable Corner Clamp	Card	6	24
59162	90° Corner Clamp	Card	6	24



## Band Clamp

- Powder coated metal frame with chrome plated hardware
- Quick locking/release cam lever

ITEM NUMBER	DESCRIPTION	PACKAGE	SHIP QTY	CASE QTY
59168	15 ft Band Clamp	Card	6	24

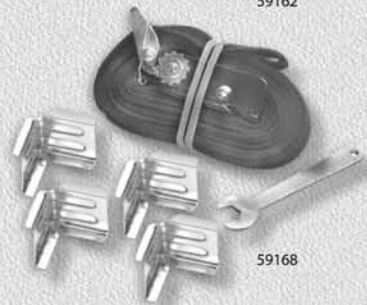

## Power Clamp

- Pivoting rubberized tips hold tight, even on irregular surfaces
- Jaw design grips from 1-1/2" to 3" pipe, conduit or tubing
- Durable nylon construction
- Quick, one finger pressure release for one hand use

ITEM NUMBER	DESCRIPTION	PACKAGE	SHIP QTY	CASE QTY
62652	3" Power Clamp	Bulk	6	48



## Forged L-Clamps

- Sliding arm for quick and easy set-up
- Copper plated spindle resists weld splash
- Heavy duty forged steel

ITEM NUMBER	DESCRIPTION	PACKAGE	SHIP QTY	CASE QTY
59170	3"x6" Forged L-Clamp	Card	4	48
59171	3"x12" Forged L-Clamp	Card	4	36
59173	4-1/2"x18" Forged L-Clamp	Card	5	10



## Wood Bar Clamps

- Quick release sliding jaw
- Protective clamp pads
- Precision steel bar and jaw

ITEM NUMBER	DESCRIPTION	PACKAGE	SHIP QTY	CASE QTY
59147	2-1/2"x6" Wood Bar Clamp	Card	4	48
59148	2-1/2"x12" Wood Bar Clamp	Card	4	36
59149	2-1/2"x18" Wood Bar Clamp	Card	4	24
59150	2-1/2"x24" Wood Bar Clamp	Card	3	24
59151	2-1/2"x30" Wood Bar Clamp	Card	2	12
59152	2-1/2"x36" Wood Bar Clamp	Card	2	12
59167	Bar Clamp Pads, 3 Sets	Card	6	24



## Ratcheting Bar Clamps

- Quick release button allows easy opening and closing
- Reversible jaw converts to a ratcheting spreader
- One hand operation

ITEM NUMBER	DESCRIPTION	PACKAGE	SHIP QTY	CASE QTY
59154	4" Mini Ratcheting Bar Clamp (2pk)	Card	6	36
59155	6" Ratcheting Bar Clamp	Card	6	48
59156	12" Ratcheting Bar Clamp	Card	6	36
59157	18" Ratcheting Bar Clamp	Card	6	24
59158	24" Ratcheting Bar Clamp	Card	6	24
59159	30" Ratcheting Bar Clamp	Card	4	8
59160	36" Ratcheting Bar Clamp	Card	12	12



## Metal Spring Clamps

- Extra thick pvc tips and grips
- Heavy gauge chrome plated steel
- High tension metal springs

ITEM NUMBER	DESCRIPTION	PACKAGE	SHIP QTY	CASE QTY
59177	1" Metal Spring Clamp	Card	6	36
59178	2" Metal Spring Clamp	Card	6	36
59179	3" Metal Spring Clamp	Card	6	18





### Pocket Plane

- For use on wood, drywall and automotive body filler
- Durable die cast alloy body

ITEM NO.	DESCRIPTION	PACKAGE	SHIP QTY	CASE QTY
63252	Pocket Plane	Card	6	96



### Utility Shaver

- Lightweight design for use on wood, drywall and automotive body filler
- Quick and easy click-on blade replacement

ITEM NO.	DESCRIPTION	PACKAGE	SHIP QTY	CASE QTY
63251	Utility Shaver	Card	6	96
63256	Blade Replacement for Utility Shaver	Card	12	96



### Hand Plane / Flat File

- For use on wood, drywall and automotive body filler
- Durable die cast alloy body with comfortable cushion grip

ITEM NO.	DESCRIPTION	PACKAGE	SHIP QTY	CASE QTY
63255	10" Hand Plane	Card	6	24
63253	Flat Blade Rpl. for Shaper File / Hand Plane	Card	6	192
63254	10" Shaper File	Card	6	48



### Round File

- Use to enlarge holes or shape curved surfaces
- Comfortable hardwood handles for positive control

ITEM NO.	DESCRIPTION	PACKAGE	SHIP QTY	CASE QTY
63257	10" Round File	Card	6	96
63258	Blade Replacement for Round File	Card	6	192



### Precision Needle File Set

- Lightweight durable aluminum construction
- Precision files in six assorted sizes and shapes
- Universal handle fits precision blades and files

ITEM NO.	DESCRIPTION	PACKAGE	SHIP QTY	CASE QTY
63259	Precision Needle File Set	Blister	6	48

### 30 Pc. Deluxe Precision Hobby Knife Set

- Complete assortment of precision knife handles, blades, and accessories
- Includes precision saw blade, mitre box, and scribe
- Convenient storage case keeps all your tools organized

ITEM NO.	DESCRIPTION	PACKAGE	SHIP QTY	CASE QTY
82027	30 Pc. Deluxe Precision Hobby Set	Box	6	24



### 14 Pc. Precision Knife Set

- 4-Jaw aluminum chuck for safety and durability
- Lightweight, durable aluminum construction
- 12 Blades in various shapes and sizes for all applications

ITEM NO.	DESCRIPTION	PACKAGE	SHIP QTY	CASE QTY
82028	14 Pc. Precision Knife Set	Blister	6	48



### 17 Pc. Precision Hobby Knife Set

- Lightweight durable aluminum and injected handles
- 13 blades in various shapes and sizes for all applications
- Compact storage case keeps all tools organized

ITEM NO.	DESCRIPTION	PACKAGE	SHIP QTY	CASE QTY
82029	17 Pc. Precision Hobby Knife Set	Box	6	48



### Mitre Box Razor Blade Saw Set

- 4-Jaw aluminum chuck for safety and durability
- Lightweight, durable aluminum mitre box, with 45° and 90° angles
- Includes one 5" / 24TPI Razor Blade Saw 1-1/4" Deep

ITEM NO.	DESCRIPTION	PACKAGE	SHIP QTY	CASE QTY
31981	Mitre Box Razor Blade Saw Set	Blister	6	48



### Knife Handles

- 4-Jaw aluminum chuck for safety and durability
- Lightweight, durable aluminum mitre box, with 45° and 90° angles

ITEM NO.	DESCRIPTION	PACKAGE	SHIP QTY	CASE QTY
82031	#1 Precision Knife	Blister	12	144
82035	#2 Precision Knife	Blister	12	144
82088	Hobby Knife	Blister	12	144
82033	#1 Precision Knife with Soft Grip	Blister	12	144



### #4 Precision Knife and Saw Handle

- 4-Jaw aluminum chuck for safety and durability
- Lightweight durable molded plastic handle
- For use with precision blades and razor blade saws

ITEM NO.	DESCRIPTION	PACKAGE	SHIP QTY	CASE QTY
82031	#4 Precision Knife and Saw Handle	Blister	12	144





### 360° Swivel Blade Precision Knife

- Blade swivels with slight turns for cutting arcs, curves and circles
- Lightweight, durable aluminum construction, with ball pin to flatten surfaces
- Includes 3 replacement blades

ITEM NO.	DESCRIPTION	PACKAGE	SHIP QTY	CASE QTY
82030	360° Swivel Blade Precision Knife	Blister	12	144

### Replacement Blades

- Most common blade sizes and shapes
- Includes 5 blades and clear plastic reusable tube\*

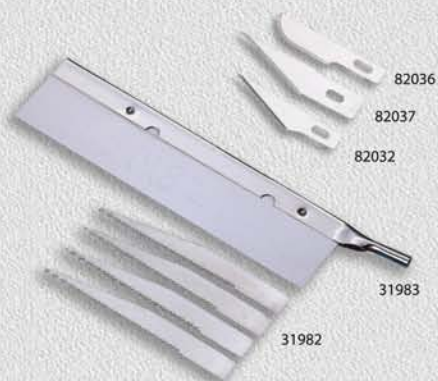

ITEM NO.	DESCRIPTION	PACKAGE	SHIP QTY	CASE QTY
82034	5 Pc. #1 Replacement Blades*	Blister	12	144
82037	5 Pc. #10 Replacement Blades*	Blister	12	144
82036	5 Pc. #11 Replacement Blades*	Blister	12	144
31982	5 Pc. 3 1/2" / 14 TPI Saw Blade	Blister	6	144
31983	5" / 54 TPI Razor Saw Blade, 1/4" Deep	Blister	6	144

### Electronic Digital Caliper

- 6" / 150mm internal and external measuring capacity
- Measures SAE to 0.0005", and metric to 0.01mm, 0.001 accuracy
- Floating zero function and position lock
- Hardened stainless steel
- Includes storage case and two batteries



ITEM NO.	DESCRIPTION	PACKAGE	SHIP QTY	CASE QTY
82806	Electronic Digital Caliper	Clam	4	24

### Project Partner with 3.5" Glass Magnifier

- Provides an extra hand for electrical, precision and detail jobs
- Adjustable alligator-style clips for holding a variety of objects
- Coiled soldering iron/tool holder



ITEM NO.	DESCRIPTION	PACKAGE	SHIP QTY	CASE QTY
62654	Project Partner with 3.5" Glass Magnifier	Clam	4	16

### 8" Rectangle Magnetic Parts Tray

- Stainless Steel Tray with Non-marring Rubber Coated Magnets
- Holds a Variety of Tools, Fasteners, and Small Metal Parts



ITEM NO.	DESCRIPTION	PACKAGE	SHIP QTY	CASE QTY
60212	8" Rectangle Magnetic Parts Tray	Clam	4	24

### Fast-Fit™ Ratcheting Adjustable Wrenches

- Patented spring-loaded ratchet wheel allows quick tightening or loosening – wrench does not need to be removed from the fastener after each turn
- Chrome vanadium steel with non-slip molded grip
- Laser etched size markings on jaws, corrosion resistant satin finish

ITEM NO.	DESCRIPTION	PACKAGE	SHIP QTY	CASE QTY
15007	6" Fast-Fit™ Ratcheting Adjustable Wrench	Hangtag	6	48
15009	8" Fast-Fit™ Ratcheting Adjustable Wrench	Hangtag	6	48
15011	10" Fast-Fit™ Ratcheting Adjustable Wrench	Hangtag	6	48



### Adjustable Wrenches - Satin Finish

- Drop forged chrome vanadium
- Wide handle I-Beam design\*
- SAE and metric graduated markings

ITEM NO.	DESCRIPTION	PACKAGE	SHIP QTY	CASE QTY
15004	4" Adjustable Wrench, satin finish	Label	6	48
15006	6" Adjustable Wrench, I-Beam satin finish*	Label	6	48
15008	8" Adjustable Wrench, I-Beam satin finish*	Label	6	48
15010	10" Adjustable Wrench, I-Beam satin finish*	Label	3	36
15012	12" Adjustable Wrench, I-Beam satin finish*	Label	3	24
15015	15" Adjustable Wrench, I-Beam satin finish*	Label	2	16
15018	18" Adjustable Wrench, satin finish	Label	1	10



### Adjustable Wrenches - Black Phosphate Finish

- Drop forged chrome vanadium
- Wide handle I-Beam design
- Oil resistant black phosphate finish

ITEM NO.	DESCRIPTION	PACKAGE	SHIP QTY	CASE QTY
15306	6" Adjustable Wrench, I-Beam black phosphate	Hangtag	6	48
15308	8" Adjustable Wrench, I-Beam black phosphate	Hangtag	6	48
15310	10" Adjustable Wrench, I-Beam black phosphate	Hangtag	3	36
15312	12" Adjustable Wrench, I-Beam black phosphate	Hangtag	3	24
15315	15" Adjustable Wrench, I-Beam black phosphate	Hangtag	2	16



### Heavy Duty Pipe Wrenches

- Available in heavy duty cast iron, or lightweight aluminum
- Spring loaded drop-forged carbon steel jaws

ITEM NO.	DESCRIPTION	PACKAGE	SHIP QTY	CASE QTY
11708	8" Heavy Duty Pipe Wrench	Label	6	48
11710	10" Heavy Duty Pipe Wrench	Label	6	36
11714	14" Heavy Duty Pipe Wrench	Label	5	20
11718	18" Heavy Duty Pipe Wrench	Label	2	12
11724	24" Heavy Duty Pipe Wrench	Label	1	6
11736	36" Heavy Duty Pipe Wrench	Label	1	4
11814	14" Aluminum Heavy Duty Pipe Wrench	Label	6	24
11818	18" Aluminum Heavy Duty Pipe Wrench	Label	6	12
11824	24" Aluminum Heavy Duty Pipe Wrench	Label	6	6
11836	36" Aluminum Heavy Duty Pipe Wrench	Label	1	3



## Screwdrivers and Sets

- Cr-V blades with satin finish
- Precision machined tips resist "cam-out"

ITEM NO.	DESCRIPTION	PACKAGE	SHIP QTY	CASE QTY
17001	#1 x 3" Phillips Screwdriver	Tag	12	96
17002	#2 x 4" Phillips Screwdriver	Tag	12	96
17003	#3 x 6" Phillips Screwdriver	Tag	12	96
17004	#2 x 1 1/2" Stubby Phillips Screwdriver	Tag	12	96
17005	#2 x 8" Phillips Screwdriver	Tag	12	96
17006	1/4" x 1 1/2" Slotted Stubby Screwdriver	Tag	12	96
17007	3/16" x 3" Slotted Screwdriver	Tag	12	96
17008	3/16" x 4" Slotted Screwdriver	Tag	12	96
17009	3/16" x 6" Slotted Screwdriver	Tag	12	96
17010	1/4" x 4" Slotted Screwdriver	Tag	12	96
17011	1/4" x 6" Slotted Screwdriver	Tag	12	96
17012	1/4" x 8" Slotted Screwdriver	Tag	12	96
17013	5/16" x 6" Slotted Screwdriver	Tag	12	96
17100	6-in-1 Screwdriver	Tag	12	96
17101	6-in-1 Torx Driver	Clam	6	48
17210	T10 Torx Screwdriver	Tag	12	96
17215	T15 Torx Screwdriver	Tag	12	96
17220	T20 Torx Screwdriver	Tag	12	96
17225	T25 Torx Screwdriver	Tag	12	96
17227	T27 Torx Screwdriver	Tag	12	96
17230	T30 Torx Screwdriver	Tag	12	96

## Folding Driver Sets

- Chrome vanadium alloy
- Non-slip molded grips

ITEM NO.	DESCRIPTION	PACKAGE	SHIP QTY	CASE QTY
85331	8 Pc. Folding Metric Hex Key Set	Card	4	24
85332	9 Pc. Folding SAE Hex Key Set	Card	4	24
55070	8 Pc. Folding Torx Set	Card	4	24
55072	8 Pc. Folding Phillips/Slotted Screwdriver Set	Card	4	24

## 8" Leverench™ Self Sizing Wrench

- Spring loaded jaw keeps constant contact to fastener and wrench reverse direction without repositioning
- Thumb lever for one hand operation
- Adjusts from 3/8" to 11/16"

ITEM NO.	DESCRIPTION	PACKAGE	SHIP QTY	CASE QTY
31003SH	8" Leverench™ Self Sizing Wrench	Card	4	24



## Screwdrivers and Sets

- Cr-V blades, with satin finish
- Precision machined tips resist "cam-out"
- Color coded two-material non-slip grips

ITEM NO.	DESCRIPTION	PACKAGE	SHIP QTY	CASE QTY
55026	1/8" x 3" Slotted Screwdriver	Tag	12	96
55027	1/4" x 1 1/2" Slotted Screwdriver	Tag	12	96
55028	3/16" x 4" Slotted Screwdriver	Tag	12	96
55029	3/16" x 6" Slotted Screwdriver	Tag	12	96
55030	1/4" x 4" Slotted Screwdriver	Tag	12	96
55031	5/16" x 6" Slotted Screwdriver	Tag	12	96
55032	3/8" x 10" Slotted Screwdriver	Tag	12	96
55033	#0 x 3" Phillips Screwdriver	Tag	12	96
55034	#1 x 3" Phillips Screwdriver	Tag	12	96
55035	#2 x 1 1/2" Phillips Screwdriver	Tag	12	96
55036	#2 x 4" Phillips Screwdriver	Tag	12	96
55037	#3 x 6" Phillips Screwdriver	Tag	12	96
55051	3/16" x 3" Nut Driver	Tag	12	96
55052	1/4" x 3" Nut Driver	Tag	12	96
55053	5/16" x 3" Nut Driver	Tag	12	96
55054	11/32" x 3" Nut Driver	Tag	12	96
55055	3/8" x 3" Nut Driver	Tag	12	96
55056	7/16" x 3" Nut Driver	Tag	12	96
55057	1/2" x 3" Nut Driver	Tag	12	96
55058	S1 x 4" Square Drive Screwdriver	Tag	12	96
55059	S2 x 4" Square Drive Screwdriver	Tag	12	96
55060	S3 x 4" Square Drive Screwdriver	Tag	12	96
55061	T10 x 4" Torx Drive Screwdriver	Tag	12	96
55062	T15 x 4" Torx Drive Screwdriver	Tag	12	96
55063	T20 x 4" Torx Drive Screwdriver	Tag	12	96
55064	T25 x 4" Torx Drive Screwdriver	Tag	12	96
55065	T27 x 4" Torx Drive Screwdriver	Tag	12	96
55066	T30 x 4" Torx Drive Screwdriver	Tag	12	96
55038	3 Pc. Square Drive Screwdriver Set	Clam	6	48
55039	4 Pc. Nut Driver Set	Clam	6	48
55040	4 Pc. Torx Screwdriver Set	Clam	6	48
55041	6 Pc. Screwdriver Set	Clam	6	36

## 13 Pc. Precision Ratchet Driver Bit Set

- Patented reversible ratchet delivers greater torque
- Comfortable two material cushion grip
- Includes 10 precision bits, 4-1/2" extension, and storage case

ITEM NO.	DESCRIPTION	PACKAGE	SHIP QTY	CASE QTY
59005	13 Pc. Precision Ratchet Driver Bit Set	Card	6	48



## XLDriver™ Max Torque

- Delivers up to 50% more torque than standard drivers
- One piece forged ratcheting mechanism
- Six double-ended bits store inside handle

ITEM NO.	DESCRIPTION	PACKAGE	SHIP QTY	CASE QTY
35043	XLDriver™ Maximum Torque, 19-in-1	Half Clam	6	48

## XLDriver™

- High torque reversible mechanism
- Impact resistant ABS construction
- Heat treated chrome vanadium double ended bits

ITEM NO.	DESCRIPTION	PACKAGE	SHIP QTY	CASE QTY
35037CD	XLDriver™ 12-n-1 Ratcheting Driver in CD	Clam	12	48
35039CD	XLDriver™ II Stubby Ratcheting Driver in CD	Bulk	12	96
35041	XLDriver™ Stubby Combo Pack	Clam	6	48
35042	XLDriver™ Precision	Clam	6	48
35044	XLDriver™ Precision Combo Pack	Clam	6	48

## DualDriver™

- 2 Position pivoting handle for extra torque
- High torque ratchet mechanism
- Includes 6 chrome vanadium driver bits

ITEM NO.	DESCRIPTION	PACKAGE	SHIP QTY	CASE QTY
35038	DualDriver™ Ratcheting Screwdriver	Clam	6	48

## Ratcheting Screwdrivers

- High torque ratchet mechanism
- Chrome vanadium driver bits

ITEM NO.	DESCRIPTION	PACKAGE	SHIP QTY	CASE QTY
35028CD	Stubby Ratcheting Screwdriver in CD	Bulk	24	192
35028PHM	Stubby Ratcheting Screwdriver in PHM	Bulk	10	40

## Scratch Awl

- Use to start screws or scribe wood and metal for cutting
- Heat treated and tempered blade
- Durable acetate handle

ITEM NO.	DESCRIPTION	PACKAGE	SHIP QTY	CASE QTY
35034	Scratch Awl	Card	6	240

## Pliers

- Induction hardened chrome vanadium
- Precision machined teeth and cutting edges
- Non-slip molded grips

ITEM NO.	DESCRIPTION	PACKAGE	SHIP QTY	CASE QTY
15106	6" Slip Joint Pliers	Tag	6	48
15108	8" Slip Joint Pliers	Tag	6	48
15110	10" Slip Joint Pliers	Tag	6	48
15150	8" Tongue and Groove Pliers	Tag	6	48
15151	10" Tongue and Groove Pliers	Tag	6	48
15152	12" Tongue and Groove Pliers	Tag	6	48
15201	6" Diagonal Pliers	Tag	6	48
15202	7 1/2" Diagonal Pliers	Tag	6	48
15205	7" Linesman Pliers	Tag	6	48
15206	8" Linesman Pliers	Tag	6	48
15210	6" Long Nose Pliers	Tag	6	48
15211	8" Long Nose Pliers	Tag	6	48
15220	11" Straight Long Reach Pliers	Tag	12	48
15221	11" Bent Nose Long Reach Pliers	Tag	12	48
15411	10" Fence Pliers	Tag	6	30

## Lock Grip Pliers

- Drop forged chrome molybdenum jaws
- Precision machined and hardened adjustment screw

ITEM NO.	DESCRIPTION	PACKAGE	SHIP QTY	CASE QTY
15230	5" Curve Jaw Lock Grip Pliers	Tag	6	48
15231	7" Curve Jaw Lock Grip Pliers	Tag	6	48
15232	10" Curve Jaw Lock Grip Pliers	Tag	6	36

## Bolt Cutters

- Induction hardened chrome vanadium
- Adjustable jaw cutting depth
- Available replacement jaws

ITEM NO.	DESCRIPTION	REPLACEMENT JAWS	PACKAGE	SHIP QTY	CASE QTY
15408	8" Mini Bolt Cutter	(15409)	Label	6	48
15414	14" Heavy Duty Bolt Cutter	(15415)	Label	1	20
15418	18" Heavy Duty Bolt Cutter	(15419)	Label	1	20
15424	24" Heavy Duty Bolt Cutter	(15425)	Label	1	10
15430	30" Heavy Duty Bolt Cutter	(15431)	Label	1	6
15436	36" Heavy Duty Bolt Cutter	(15437)	Label	1	5

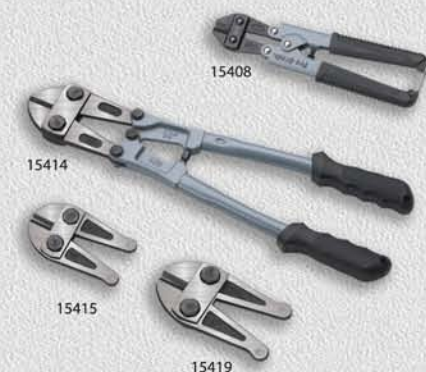
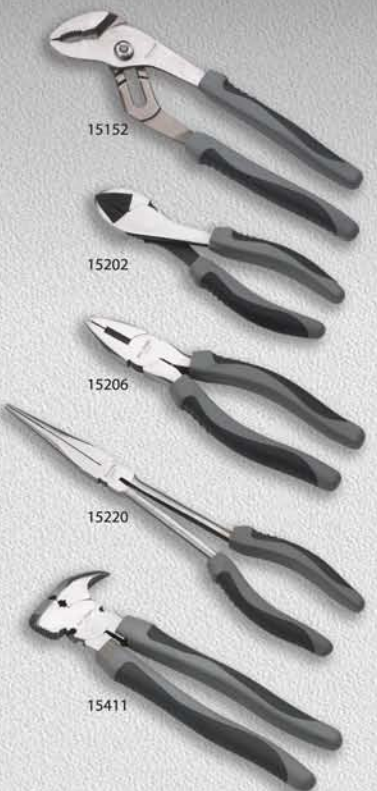

Model No.	Description	Page No.	Model No.	Description	Page No.
11708	8" Heavy Duty Pipe Wrench	23	15437	36" Bolt Cutter Replacement Jaws	27
11710	10" Heavy Duty Pipe Wrench	23	15608	8 oz Ball Pein Hammer, Fiberglass	15
11714	14" Heavy Duty Pipe Wrench	23	15616	16 oz Ball Pein Hammer, Fiberglass	15
11718	18" Heavy Duty Pipe Wrench	23	15624	24 oz Ball Pein Hammer, Fiberglass	15
11724	24" Heavy Duty Pipe Wrench	23	15632	32 oz Ball Pein Hammer, Fiberglass	15
11736	36" Heavy Duty Pipe Wrench	23	17001	#1 x 3" Phillips Screwdriver	24
11814	14" Aluminum Heavy Duty Pipe Wrench	23	17002	#2 x 4" Phillips Screwdriver	24
11818	18" Aluminum Heavy Duty Pipe Wrench	23	17003	#3 x 6" Phillips Screwdriver	24
11824	24" Aluminum Heavy Duty Pipe Wrench	23	17004	#2 x 1 1/2" Stubby Phillips Screwdriver	24
11836	36" Aluminum Heavy Duty Pipe Wrench	23	17005	#2 x 8" Phillips Screwdriver	24
15004	4" Satin Finish Adjustable Wrench	23	17006	1/4" x 1 1/2" Stubby Screwdriver	24
15006	6" Satin Finish Adjustable Wrench	23	17007	3/16" x 3" Round Cabinet Screwdriver	24
15007	6" Fast-Fit™ Ratcheting Adjustable Wrench	23	17008	3/16" x 4" Round Cabinet Screwdriver	24
15008	8" Satin Finish Adjustable Wrench	23	17009	3/16" x 6" Round Cabinet Screwdriver	24
15009	8" Fast-Fit™ Ratcheting Adjustable Wrench	23	17010	1/4" x 4" Standard Screwdriver	24
15010	10" Satin Finish Adjustable Wrench	23	17011	1/4" x 6" Standard Screwdriver	24
15011	10" Fast-Fit™ Ratcheting Adjustable Wrench	23	17012	1/4" x 8" Standard Screwdriver	24
15012	12" Satin Finish Adjustable Wrench	23	17013	5/16" x 6" Standard Screwdriver	24
15015	15" Satin Finish Adjustable Wrench	23	17100	6-in-1 Screwdriver	24
15018	18" Satin Finish Adjustable Wrench	23	17101	6-in-1 Torx Driver	24
15106	6" Slip Joint Pliers	27	17210	T10 Torx Screwdriver	24
15108	8" Slip Joint Pliers	27	17215	T15 Torx Screwdriver	24
15110	10" Slip Joint Pliers	27	17220	T20 Torx Screwdriver	24
15150	8" Tongue and Groove Pliers	27	17225	T25 Torx Screwdriver	24
15151	10" Tongue and Groove Pliers	27	17227	T27 Torx Screwdriver	24
15152	12" Tongue and Groove Pliers	27	17230	T30 Torx Screwdriver	24
15201	6" Diagonal Pliers	27	31003SH	8" Leverench™ Self Sizing Wrench	24
15202	7 1/2" Diagonal Pliers	27	31358	20 oz. Rip Framing Hammer, Jacketed Fiberglass Handle	14
15205	7" Linesman Pliers	27	31680	Aviation Tin Snips Left - red	7
15206	8" Linesman Pliers	27	31681	Aviation Tin Snips Straight - yellow	7
15210	6" Long Nose Pliers	27	31682	Aviation Tin Snips Right - green	7
15211	8" Long Nose Pliers	27	31910	Mini Hack / Coping Saw	10
15220	11" Straight Long Reach Pliers	27	31910TR	Mini Hack / Coping Saw in TR	10
15221	11" Bent Nose Long Reach Pliers	27	31911	5 Pc. Mini Hack / Coping Saw Blades	10
15230	5" Curve Jaw Lock Grip Pliers	27	31912	High Tension Hacksaw with Rubber Grip	10
15231	7" Curve Jaw Lock Grip Pliers	27	31913	Bow Saw / Hacksaw	10
15232	10" Curve Jaw Lock Grip Pliers	27	31915	2 Pc. Bow Saw Replacement Blades	10
15306	6" Adjustable Wrench, I-Beam Black Phosphate	23	31916	Utility Hacksaw	11
15308	8" Adjustable Wrench, I-Beam Black Phosphate	23	31917	Jab Saw	11
15312	10" Adjustable Wrench, I-Beam Black Phosphate	23	31918	Wallboard Saw	11
15315	12" Adjustable Wrench, I-Beam Black Phosphate	23	31922	Aggressive Tooth Keyhole Saw	11
15315	15" Adjustable Wrench, I-Beam Black Phosphate	23	31955	10" / 24 TPI Hacksaw Blade - Carbon	11
15408	8" Mini Bolt Cutter	27	31956	10" / 18 TPI Hacksaw Blade - Carbon	11
15411	10" Fence Pliers	27	31957	12" / 18 TPI Hacksaw Blade - Carbon	11
15414	14" Heavy Duty Bolt Cutter	27	31958	12" / 32 TPI Hacksaw Blade - Carbon	11
15415	14" Bolt Cutter Replacement Jaws	27	31959	12" / 24 TPI Hacksaw Blade - Carbon	11
15418	18" Heavy Duty Bolt Cutter	27	31960	12" / 32 TPI Hacksaw Blade - Bi Metal	11
15419	18" Bolt Cutter Replacement Jaws	27	31961	12" / 24 TPI Hacksaw Blade - Bi Metal	11
15424	24" Heavy Duty Bolt Cutter	27	31962	5 Pc. Coping Saw Blades	9
15425	24" Bolt Cutter Replacement Jaws	27	31963	6 3/4" Coping Saw, Wood Handle	9
15430	30" Heavy Duty Bolt Cutter	27	31964	4 3/4" Coping Saw, Wood Handle	9
15431	30" Bolt Cutter Replacement Jaws	27	31965	10" / 15 Pt. Dovetail Saw, Wood Handle	9
15436	36" Heavy Duty Bolt Cutter	27	31966	10" / 13 Pt. Reversing Back Saw, Wood Handle	9

Model No.	Description	Page No.	Model No.	Description	Page No.
31967	12" / 8 Pt. Compass Saw, TPR Handle	9	55041	6 Pc. Screwdriver Set	25
31968	14" / 12 Pt. Miter Back Saw, Wood Handle	8	55051	3/16" x 3" Nut Driver	25
31969	15" / 9 Pt. Drywall Saw, Wood Handle	8	55052	1/4" x 3" Nut Driver	25
31970	15" / 12 Pt. Tool Box Saw, Wood Handle	8	55053	5/16" x 3" Nut Driver	25
31971	20" / 10 Pt. Hand Saw, Wood Handle	8	55054	11/32" x 3" Nut Driver	25
31972	26" / 8 Pt. General Purpose Saw, Wood Handle	8	55055	3/8" x 3" Nut Driver	25
31973	15" / 9 Pt. Tool Box Saw, TPR Handle	8	55056	7/16" x 3" Nut Driver	25
31974	20" / 12 Pt. Hand Saw, TPR Handle	8	55057	1/2" x 3" Nut Driver	25
31975	High Tension Aluminum Frame Hacksaw	10	55058	S1 x 4" Square Drive Screwdriver	25
31977	Adjustable Frame Hacksaw, Rubber Grip	10	55059	S2 x 4" Square Drive Screwdriver	25
31978	20" / 8 Pt. Hand Saw, Plastic Handle	8	55060	S3 x 4" Square Drive Screwdriver	25
31981	Mitre Box Razor Blade Saw Set	21	55061	T10 x 4" Torx Drive Screwdriver	25
31982	5 Pc. 3 1/2" / 14 TPI Saw Blade, 1/4" Tapered	22	55062	T15 x 4" Torx Drive Screwdriver	25
31983	5" / 54TPI Razor Blade Saw 1-1/4" Deep	22	55063	T20 x 4" Torx Drive Screwdriver	25
35028CD	Stubby Ratcheting Screwdriver in CD	26	55064	T25 x 4" Torx Drive Screwdriver	25
35028PHM	Stubby Ratcheting Screwdriver in PHM	26	55065	T27 x 4" Torx Drive Screwdriver	25
35034	Scratch Awl	26	55066	T30 x 4" Torx Drive Screwdriver	25
35037CD	XLDriver™ 12-in-1 Ratcheting Driver in CD	26	55070	8pc Folding Torx Set	24
35038	DualDriver™ Ratcheting Screwdriver w/ Pivoting Handle	26	55072	8pc Folding Phillips/Slotted Screwdriver Set	24
35039CD	XLDriver™ II Stubby Ratcheting Driver in CD	26	59005	13 Pc. Precision Ratchet Driver Bit Set	25
35041	XLDriver™ Combo Pack	26	59109	3" Workshop Clamp Vise	16
35042	XLDriver™ Precision	26	59110	4" Workshop Bench Vise	16
35043	XLDriver™ Maximum Torque 19-in-1	26	59111	5" Workshop Bench Vise	16
35044	XLDriver™ Combo Set (Precision and Original)	26	59112	6" Workshop Bench Vise	16
39955	Mitre Box		59113	4" Mechanic's Bench Vise	16
42800	1/4" x 10' Tape Measure, Chrome Case	13	59114	5" Mechanic's Bench Vise	16
42801	1/2" x 12' Tape Measure, Chrome Case	13	59115	6" Mechanic's Bench Vise	16
42802	3/4" x 16' Tape Measure, Chrome Case	13	59116	7" Mechanic's Bench Vise	16
42803	1" x 25' Tape Measure, Chrome Case	13	59118	5" Multi-Purpose Mechanic Vise	16
42804	1" x 30' Tape Measure, Chrome Case	13	59120	4" Flat Drill Press Vise	17
42805	1" x 35' Tape Measure, Chrome Case	13	59121	3-1/2" Angle Drill Press Vise	17
42807	1" x 25' Auto Locking Tape Measure	12	59122	6-1/2" Woodworkers Vise	17
42808	1" x 30' Auto Locking Tape Measure	12	59124	3" Hobby Vise	16
42810	3/8" x 100' Steel Tape Measure with Rubber Grip	13	59128	1"x1" C-Clamp	17
42811	1-3/16" x 25' XLRule™ Tape Measure	12	59129	1-1/2"x1-1/2" C-Clamp (deep throat)	17
42812	1 3/16" x 30' XLRule™ Tape Measure	12	59130	2"x1" C-Clamp	17
42813	1-5/8" x 25' Magnum Tape Measure	12	59131	2"x3-1/2" C-Clamp (deep throat)	17
42815	1-5/16" x 25' Magnum Tape Measure	12	59132	2-1/2"x1-3/8" C-Clamp	17
55026	1/8" x 3" Slotted Screwdriver	25	59133	2-1/2"x2-1/2" C-Clamp	17
55027	1/4" x 1 1/2" Slotted Screwdriver	25	59134	3"x2" C-Clamp	17
55028	3/16" x 4" Slotted Screwdriver	25	59135	3"x4-1/2" C-Clamp (deep throat)	17
55029	3/16" x 6" Slotted Screwdriver	25	59136	4"x3" C-Clamp	17
55030	1/4" x 4" Slotted Screwdriver	25	59137	5"x3-1/4" C-Clamp	17
55031	5/16" x 6" Slotted Screwdriver	25	59138	6"x3-1/2" C-Clamp	17
55032	3/8" x 10" Slotted Screwdriver	25	59139	8"x4" C-Clamp	17
55033	#0 x 3" Phillips Screwdriver	25	59141	4"x2-1/4" Quick Release C-Clamp	17
55034	#1 x 3" Phillips Screwdriver	25	59142	5"x2-1/2" Quick Release C-Clamp	17
55035	#2 x 1 1/2" Phillips Screwdriver	25	59143	6"x3" Quick Release C-Clamp	17
55036	#2 x 4" Phillips Screwdriver	25	59147	2-1/2"x6" Wood Bar Clamp	19
55037	#3 x 6" Phillips Screwdriver	25	59148	2-1/2"x12" Wood Bar Clamp	19
55038	3 Pc. Square Drive Screwdriver Set	25	59149	2-1/2"x18" Wood Bar Clamp	19
55039	4 Pc. Nut Driver Set	25	59150	2-1/2"x24" Wood Bar Clamp	19
55040	4 Pc. Torx Screwdriver Set	25	59151	2-1/2"x30" Wood Bar Clamp	19

Model No.	Description	Page No.	Model No.	Description	Page No.
59152	2-1/2"x36" Wood Bar Clamp	19	63028	3/4" Wood Chisel	15
59154	4" Mini Ratcheting Bar Clamp	19	63029	1" Wood Chisel	15
59155	6" Ratcheting Bar Clamp	19	63030	1-1/4" Wood Chisel	15
59156	12" Ratcheting Bar Clamp	19	63031	1-1/2" Wood Chisel	15
59157	18" Ratcheting Bar Clamp	19	63032	4 Pc. Wood Chisel Set	15
59158	24" Ratcheting Bar Clamp	19	63251	Utility Shaver	20
59159	30" Ratcheting Bar Clamp	19	63252	Pocket Plane	20
59160	36" Ratcheting Bar Clamp	19	63253	Replacement Blade for Flat File / Hand Plane	20
59161	Adjustable Corner Clamp	18	63254	10" Flat File	20
59162	90° Corner Clamp	18	63255	10" Hand Plane	20
59163	2-1/2" 3-way C-Clamp	17	63256	Utility Shaver Replacement Blade	20
59164	1/2" Pipe Clamp	18	63257	10" Round File	20
59165	3/4" Pipe Clamp	18	63258	Round File Replacement Blade	20
59166	Pipe Clamp Pads, 2 sets	18	63259	6 Pc. Precision Needle File Set	20
59167	Bar Clamp Pads, 3 sets	19	82026	Fastback Folding Utility Knife	4
59168	Band Clamp	18	82027	30pc Deluxe Precision Hobby Knife Set	21
59170	3"x6" Forged L-Clamp	19	82028	14pc Precision Knife Set	21
59171	3"x12" Forged L-Clamp	19	82029	17pc Precision Hobby Knife Set	21
59173	4-1/2"x18" Forged L-Clamp	19	82030	360° Swivel Blade Precision Knife	22
59177	1" Metal Spring Clamp	19	82031	#4 Precision Knife / Saw Handle	22
59178	2" Metal Spring Clamp	19	82032	#1 Precision Knife	21
59179	3" Metal Spring Clamp	19	82033	#1 Soft Grip Precision Knife	21
59180	1" Nylon Spring Clamp	18	82034	#1 Replacement blades, 5pc in tube	22
59181	2" Nylon Spring Clamp	18	82035	#2 Precision Knife	21
59182	3" Nylon Spring Clamp	18	82036	#10 Replacement blades, 5pc in tube	22
60212	8" Rectangle Magnetic Parts Tray	22	82037	5 Pc. #11 Replacement Blades in Tube	22
61329	15" Flat Pry Bar	15	82061	Pro-Grip Heavy Duty Utility Knife	4
61334	13 oz. Claw Hammer, Hickory Handle	14	82062	100 Pc. Utility Knife Blade Pack with Dispenser	7
61335	16 oz. Claw Hammer, Hickory Handle	14	82063	Quick Change Utility Knife	5
61336	16 oz. Rip Hammer, Hickory Handle	14	82066	Self Retracting Utility Knife	5
61339	16 oz. Claw Hammer, Jacketed Fiberglass Handle	14	82067	XLBlade™ Auto Loading Utility Knife	4
61340	16 oz. Rip Hammer, Jacketed Fiberglass Handle	14	82067CD	XLBlade™ AutoLoading Utility Knife in CD	4
61341	16 oz. Claw Hammer, Solid Steel Handle Gel Grip	14	82069	Fastback™ Utility Knife	4
61342	16 oz. Rip Hammer, Solid Steel Handle Gel Grip	14	82070	Bullet Blade	4
61343	20 oz. Claw Hammer, Solid Steel Handle Gel Grip	14	82073	5 Pc. Utility Knife Blades	7
61344	20 oz. Rip Hammer, Solid Steel Handle Gel Grip	14	82075	Glass Cutter	6
61346	22 oz. Framing Hammer, Solid Steel Milled Face Gel Grip	14	82076	Key Chain Utility Knife	5
61347	28 oz. Framing Hammer, Solid Steel Milled Face Gel Grip	14	82077	Key Chain Utility Knife Blades, 3 Pack	5
61372	1lb Dead Blow hammer	14	82078	Locking Pocket Knife	6
61373	2lb Dead Blow hammer	14	82079	Pocket Knife Sheepfoot Blade	6
61374	3lb Dead Blow hammer	14	82080	Pocket Knife Utility Blade	6
61375	4lb Dead Blow hammer	14	82081	Retractable Utility Knife	5
61377	25 oz. Framing Hammer, Hatchet Type Handle	14	82083	9mm Snap Knife	6
61384	Self Centering Punch Screw Hole	15	82084	18mm Snap Knife	6
61385	1/32" Self Centering Nail Set	15	82085	9mm Snap Knife Blades, 3 Pack	6
61386	2/32" Self Centering Nail Set	15	82086	18mm Snap Knife Blades, 3 Pack	6
61387	3/32" Self Centering Nail Set	15	82087	Fixed Blade Utility Knife - Zinc	5
61388	3 Pc. Nail Set - 1/32, 2/32, 3/32"	15	82088	Hobby Knife	21
61389	3 Pc. Nail Set - Color Coded	15	82090	Linoleum Utility Knife with Plastic Handle	6
62652	3" Power Clamp	18	82091	Carpet Utility Knife with 3 Blades	6
62654	Project Partner with 3.5" Glass Magnifier	22	82092	Carpet Knife Blades, 5 Pack	6
63026	1/4" Wood Chisel	15	82093	Razor Blade Scraper with 5 Blades	7
63027	1/2" Wood Chisel	15	82094	10 Pc. Single Edge Razor Blades	7

Model No.	Description	Page No.
82095	100 Pc. Single Edge Razor Blades	7
82096	Window Scraper	7
82097	5 Pc. Small Hook Utility Knife Blades	7
82098	5 Pc. Large Hook Utility Knife Blades	7
82806	Electronic Digital Caliper	22
82819CD	1" x 25' Powerule™ Tape Measure w/ Rubber Grip in CD	12
82819TR	1" x 25' Powerule™ Tape Measure w/ Rubber Grip in TR	12
82821	3/4" x 16' Powerule™ Tape Measure with Rubber Grip	12
82822	1" x 30' Powerule™ Tape Measure with Rubber Grip	12
82823	1/2" x 100' SpeedReel™ Fiberglass Tape Measure	13
82826	1" x 25' Powerule™ Tape Measure with Rubber Grip	12
82848	4 oz Brass Plumb Bob	13
82849	8 oz Chalk Refill Blue	13
82850	100' SpeedReel Chalk Line	13
82884	1" x 25' Tech Tape with Stainless Steel Housing	12
85331	8pc Folding Metric Hex Key Set	24
85332	9pc Folding SAE Hex Key Set	24

Merchandising Options:  
 TR = Tray; CD = Counter Display; PHM = Peg Hook Display

