

Aerovox Corp.®

Type H High Voltage AC & DC Capacitors

Film Capacitors for Power Electronics Applications

RoHS Compliant



The Type H is a very versatile metallized polypropylene capacitor that is available in a round or oval, steel or aluminum case with many terminal options to fit the application. The higher voltage ratings makes it ideal for lighting, motor run, switching power supply and converter applications.

Highlights

- High voltage up to 1200 Vac (2000 Vdc)
- UL and CUL file number E51176
- 60,000 hours operational life
- Oil filled with a environmentally “green” fluid
- Pressure interrupter meets UL810 requirements

Specifications

Capacitance Range:	0.25 μ F to 80 μ F
AC Voltage Range:	660 Vac to 1200 Vac, 50/60 Hz
DC Voltage Range:	1200 Vdc to 2000 Vdc
Temperature Range:	-40 to +90 °C
Capacitance Tolerance:	\pm 10%
Dissipation Factor (DF):	0.1% max. @ 60 Hz & 25 °C
Insulation Resistance (IR):	>1000 M Ω x μ F
Withstand Voltage:	Terminal to terminal 1.75 x WVac Terminal to case 2.0 x WVac + 1kVac
Capacitance Stability:	\pm 3% throughout life
Insulated Bushings:	High cup standard over 1000 Vac (1750 Vac)
Approval Certification:	UL and CUL file number E51176

Outline Drawing

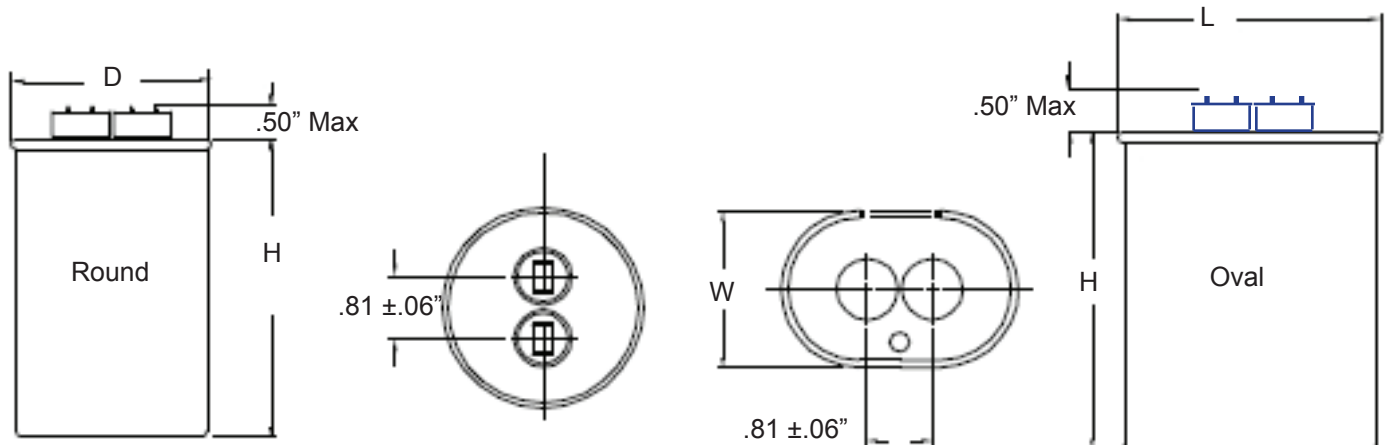

Aerovox Corp.®

Type H High Voltage AC & DC Capacitors

Performance Curves

RoHS Compliant

Capacitance Change vs Temperature @ 1KHz

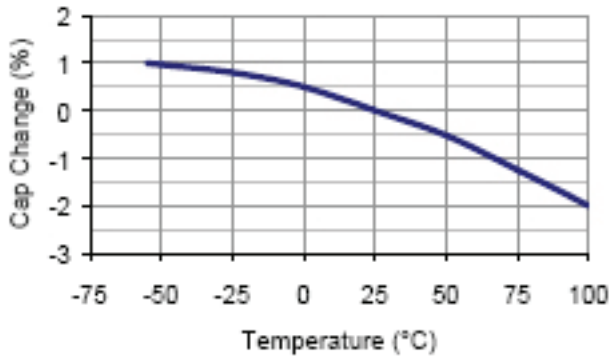

Capacitance Change vs Frequency @ 25°C

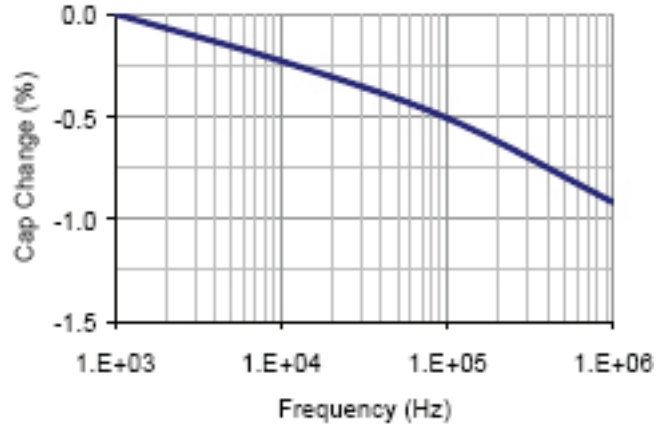

Dissipation Factor vs Temperature @ 1 KHz

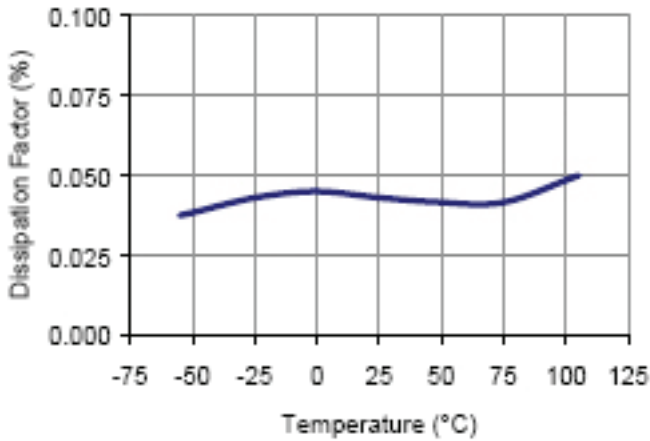

Dissipation Factor vs Frequency @ 25°C

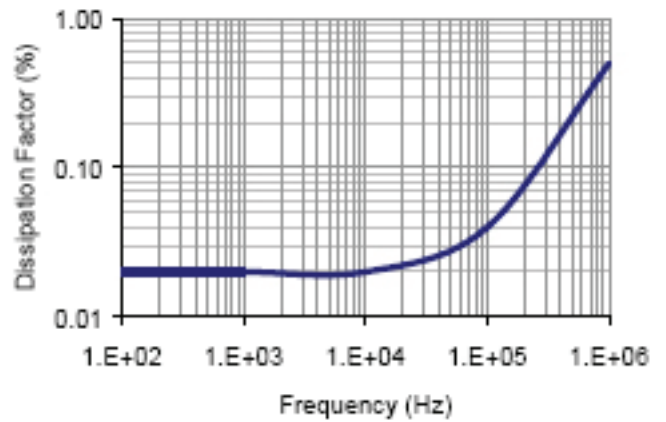

Insulation Resistance (Meg Ω x μ F) vs Temperature

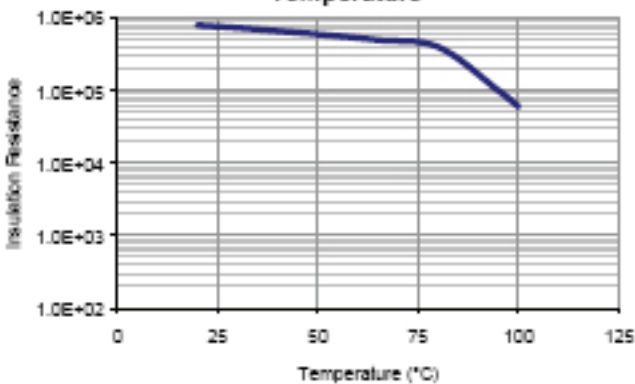

Aerovox Corp.®

Type H Part Numbering System

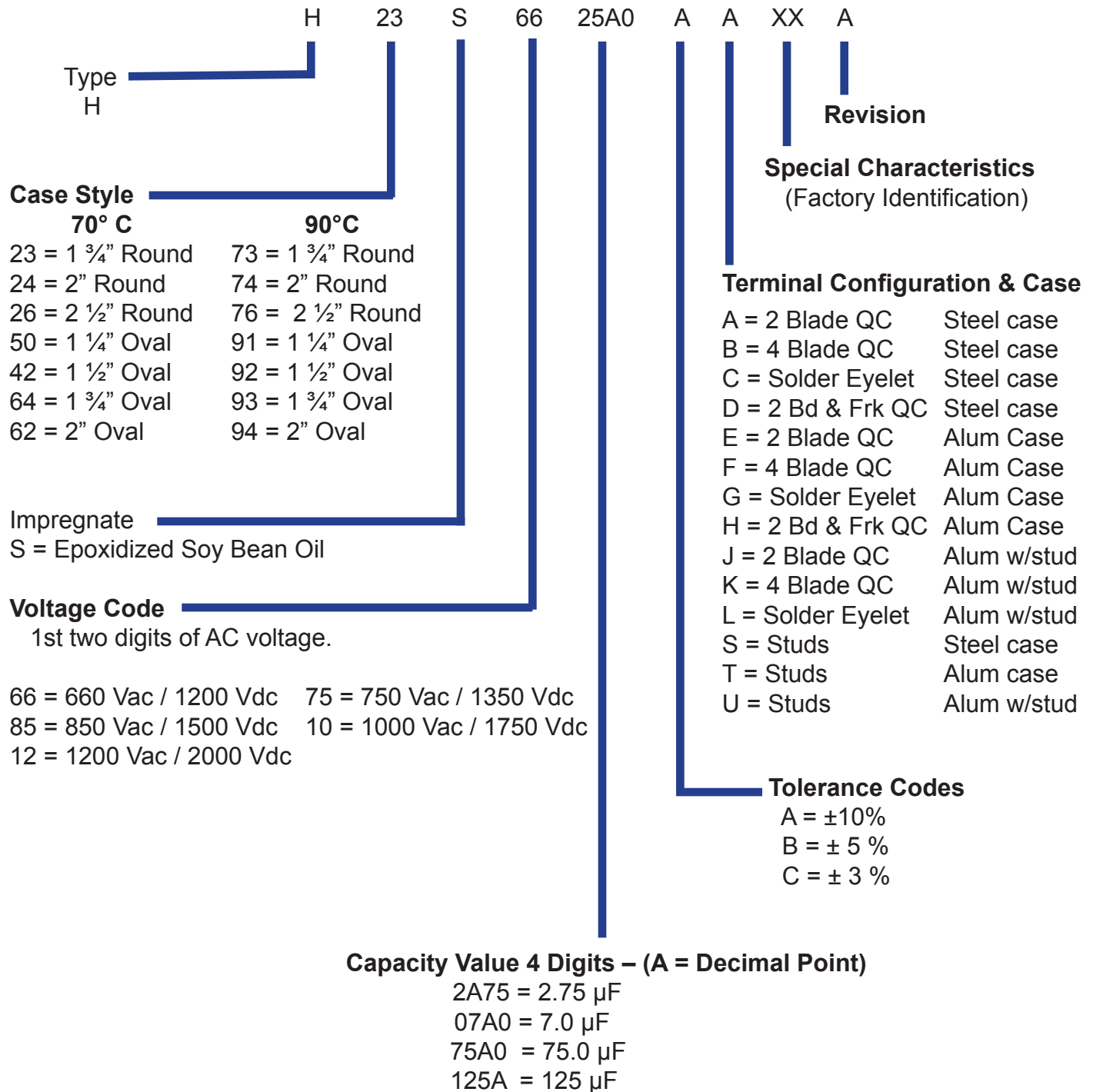

RoHS Compliant

Aerovox Corp.®

Type H High Voltage AC & DC Capacitors

Ratings - Oval Cases 70 °C

RoHS Compliant

Cap (μ F)	Catalog Part Number	Case Code	W Width (in)	L Length (in)	Case Height (in)	I_{RMS} (A)	I_{PEAK} (A)	I_s Surge (A)	DV/dt Rated (V/ μ s)	DV/dt Max. (V/ μ s)	ESR @ 60 Hz (m Ω)	DF (%)	Weight (lbs)
660 Vac (1200 Vdc) Oval 70 °C													
1	H50S6601A0AA	A	1.31	2.16	2.38	0.8	148	185	148	185	64	0.04	0.24
2	H50S6602A0AA	A	1.31	2.16	2.38	1.6	296	370	148	185	40	0.05	0.24
5	H50S6605A0AA	A	1.31	2.16	2.88	2.3	427	534	85	107	32	0.10	0.29
10	H50S6610A0AA	A	1.31	2.16	3.25	4.0	741	925	74	93	21	0.13	0.32
15	H50S6615A0AA	A	1.31	2.16	4.25	4.2	770	962	51	64	22	0.21	0.42
20	H64S6620A0AA	C	1.91	2.91	3.75	4.9	910	1136	45	57	15	0.19	0.68
25	H64S6625A0AA	C	1.91	2.91	4.25	6.6	1213	1515	49	61	15	0.23	0.76
30	H64S6630A0AA	C	1.91	2.91	4.75	7.2	1336	1668	45	56	17	0.32	0.65
35	H62S6635A0AA	D	1.97	3.66	3.75	11.5	2123	2652	61	76	11	0.24	0.97
40	H62S6640A0AA	D	1.97	3.66	3.75	13.1	2426	3030	61	76	10	0.25	0.97
45	H62S6645A0AA	D	1.97	3.66	4.25	12.9	2396	2993	53	67	10	0.29	1.08
50	H62S6650A0AA	D	1.97	3.66	4.75	12.0	2227	2781	45	56	12	0.30	1.19
60	H62S6660A0AA	D	1.97	3.66	4.75	14.4	2671	3337	45	56	11	0.42	1.19
750 Vac (1350 Vdc) Oval 70 °C													
1	H50S7501A0AA	A	1.31	2.16	2.38	1.4	266	332	266	332	80	0.05	0.24
2	H50S7502A0AA	A	1.31	2.16	2.38	2.2	411	513	205	257	40	0.05	0.24
5	H50S7505A0AA	A	1.31	2.16	3.25	2.6	480	599	96	120	48	0.15	0.32
10	H42S7510A0AA	B	1.56	2.69	3.75	4.3	788	984	79	98	35	0.22	0.56
12	H42S7512A0AA	B	1.56	2.69	3.75	5.1	946	1181	79	98	29	0.22	0.56
15	H64S7515A0AA	C	1.91	2.91	3.75	6.4	1183	1477	79	98	24	0.23	0.68
20	H62S7520A0AA	D	1.97	3.66	3.25	10.4	1919	2397	96	120	14	0.18	0.85
25	H62S7525A0AA	D	1.97	3.66	3.75	10.7	1971	2461	79	98	16	0.25	0.97
30	H62S7530A0AA	D	1.97	3.66	4.25	10.8	2006	2506	67	84	15	0.29	1.08
35	H62S7535A0AA	D	1.97	3.66	4.75	11.0	2033	2539	58	73	18	0.40	1.19
40	H62S7540A0AA	D	1.97	3.66	5.88	10.0	1855	2316	46	58	24	0.59	1.44
45	H62S7545A0AA	D	1.97	3.66	5.88	11.3	2086	2606	46	58	21	0.60	1.44
850 Vac (1500 Vdc) Oval 70 °C													
1	H50S8501A0AA	A	1.31	2.16	2.38	1.4	266	332	266	332	80	0.05	0.24
2	H50S8502A0AA	A	1.31	2.16	2.38	2.2	411	513	205	257	40	0.05	0.24
5	H42S8505A0AA	B	1.56	2.69	2.75	4.0	735	918	147	184	32	0.1	0.42
10	H64S8510A0AA	C	1.91	2.91	3.75	5.1	938	1171	94	117	30	0.19	0.68
12	H62S8512A0AA	D	1.97	3.66	3.25	7.4	1374	1716	114	143	20	0.15	0.85
15	H62S8515A0AA	D	1.97	3.66	3.75	7.6	1406	1756	94	117	21	0.2	0.97
20	H62S8520A0AA	D	1.97	3.66	4.25	8.6	1587	1982	79	99	19	0.24	1.08
25	H62S8525A0AA	D	1.97	3.66	4.75	9.3	1720	2148	69	86	22	0.34	1.19

Aerovox Corp.®

Type H High Voltage AC & DC Capacitors

Ratings - Oval Cases 70 °C

RoHS Compliant

Cap (µF)	Catalog Part Number	Case Code	W Width (in)	L Length (in)	Case Height (in)	I _{RMS} (A)	I _{PEAK} (A)	I _s Surge (A)	DV/dt Rated (V/µs)	DV/dt Max. (V/µs)	ESR @ 60 Hz (mΩ)	DF (%)	Weight (lbs)
1000 Vac (1750 Vdc) Oval 70 °C													
1	H50S1001A0AA	A	1.31	2.16	2.38	1.4	266	332	266	332	80	0.05	0.24
2	H42S1002A0AA	B	1.56	2.69	2.38	2.9	532	664	266	332	40	0.05	0.36
5	H42S1005A0AA	B	1.56	2.69	3.75	3.3	607	758	121	152	48	0.15	0.56
10	H62S1010A0AA	D	1.97	3.66	3.75	6.6	1213	1515	121	152	26	0.16	0.97
12	H62S1012A0AA	D	1.97	3.66	4.25	6.7	1233	1540	103	128	25	0.19	1.08
15	H62S1015A0AA	D	1.97	3.66	4.75	7.2	1336	1668	89	111	28	0.26	1.19
18	H62S1018A0AA	D	1.97	3.66	5.88	6.8	1266	1581	70	88	34	0.38	1.44
1200 Vac (2000 Vdc) Oval 70 °C													
2	H50S1202A0AA	A	1.31	2.16	3.25	1.8	330	412	165	206	80	0.10	0.32
5	H64S1205A0AA	C	1.91	2.91	3.75	3.6	675	844	135	169	45	0.14	0.68
10	H62S1210A0AA	D	1.97	3.66	4.25	6.2	1144	1429	114	143	27	0.17	1.08
12	H62S1212A0AA	D	1.97	3.66	4.75	6.4	1190	1486	99	124	31	0.23	1.19
15	H62S1215A0AA	D	1.97	3.66	5.88	6.4	1175	1468	78	98	36	0.34	1.44

Ratings - Round Cases 70 °C

RoHS Compliant

Cap (µF)	Catalog Part Number	Case Code	Base Diameter (in)	Case Height (in)	I _{RMS} (A)	I _{PEAK} (A)	I _s Surge (A)	DV/dt Rated (V/µs)	DV/dt Max. (V/µs)	ESR @ 60 Hz (mΩ)	DF (%)	Weight (lbs)
660 Vac (1200 Vdc) Round 70 °C												
1	H23S6601A0AA	P	1.75	2.38	0.8	148	185	148	185	64	0.04	0.26
2	H23S6602A0AA	P	1.75	2.38	1.6	296	370	148	185	40	0.05	0.26
5	H23S6605A0AA	P	1.75	2.38	3.6	665	830	133	166	19	0.06	0.26
10	H24S6610A0AA	S	2.00	2.38	7.2	1329	1659	133	166	11	0.07	0.33
15	H23S6615A0AA	P	1.75	3.25	6.0	1111	1388	74	93	15	0.14	0.36
20	H24S6620A0AA	S	2.00	3.25	8.0	1481	1850	74	93	12	0.15	0.45
25	H24S6625A0AA	S	2.00	3.75	8.2	1517	1894	61	76	13	0.20	0.51
30	H26S6630A0AA	T	2.50	3.75	9.8	1820	2273	61	76	12	0.22	0.78
35	H26S6635A0AA	T	2.50	3.75	11.5	2123	2651	61	76	11	0.23	0.78
40	H26S6640A0AA	T	2.50	3.75	13.1	2427	3031	61	76	10	0.24	0.78
45	H26S6645A0AA	T	2.50	4.25	12.5	2311	2886	51	64	11	0.30	0.86
50	H26S6650A0AA	T	2.50	4.75	12.0	2226	2781	45	56	12	0.38	0.94
60	H26S6660A0AA	T	2.50	4.75	11.4	2110	2636	35	44	11	0.41	0.94

Aerovox Corp.®

Type H High Voltage AC & DC Capacitors

Ratings - Round Cases 70 °C

RoHS Compliant

Cap (μ F)	Catalog Part Number	Case Code	Base Diameter (in)	Case Height (in)	I_{RMS} (A)	I_{PEAK} (A)	I_s Surge (A)	DV/dt Rated (V/ μ s)	DV/dt Max. (V/ μ s)	ESR @ 60 Hz (m Ω)	DF (%)	Weight (lbs)
750 Vac (1350 Vdc) Round 70 °C												
1	H23S7501A0AA	P	1.75	4.25	1.4	266	332	266	332	80	0.05	0.47
2	H23S7502A0AA	P	1.75	4.25	2.2	411	513	205	257	40	0.05	0.47
5	H23S7505A0AA	P	1.75	4.25	4.6	849	1060	170	212	26	0.08	0.47
10	H23S7510A0AA	P	1.75	4.25	9.2	1698	2120	170	212	16	0.10	0.47
12	H24S7512A0AA	S	2.00	4.25	11.0	2037	2544	170	212	13	0.10	0.57
15	H26S7515A0AA	T	2.50	4.25	13.8	2546	3180	170	212	12	0.11	0.86
20	H26S7520A0AA	T	2.50	5.88	13.3	2452	3062	123	153	15	0.19	1.11
25	H26S7525A0AA	T	2.50	5.88	15.0	3065	3828	123	153	13	0.21	1.11
30	H26S7530A0AA	T	2.50	5.88	15.0	3678	4594	123	153	12	0.23	1.11
850 Vac (1500 Vdc) Round 70 °C												
1	H23S8501A0AA	P	1.75	4.25	1.4	266	332	266	332	80	0.05	0.47
2	H23S8502A0AA	P	1.75	4.25	2.2	411	513	205	257	40	0.05	0.47
5	H23S8505A0AA	P	1.75	4.25	5.4	995	1243	199	249	22	0.07	0.47
10	H24S8510A0AA	S	2.00	4.25	5.1	938	1171	94	117	14	0.09	0.57
12	H26S8512A0AA	T	2.50	5.88	8.6	1584	1979	132	165	20	0.15	1.11
15	H26S8515A0AA	T	2.50	5.88	10.7	1980	2473	132	165	17	0.16	1.11
20	H26S8520A0AA	T	2.50	5.88	14.3	2640	3298	132	165	14	0.18	1.11
25	H26S8525A0AA	T	2.50	5.88	15.0	3300	4122	132	165	13	0.20	1.11
1000 Vac (1750 Vdc) Round 70 °C												
1	H23S1001A0AA	P	1.75	4.25	1	266	332	266	332	80	0.05	0.47
2	H23S1002A0AA	P	1.75	4.25	3	532	664	266	332	40	0.05	0.47
5	H24S1005A0AA	S	2.00	4.25	7	1329	1659	266	332	22	0.07	0.57
10	H26S1010A0AA	T	2.50	5.88	9	1708	2134	171	213	19	0.12	1.11
12	H26S1012A0AA	T	2.50	5.88	11	2050	2560	171	213	17	0.13	1.11
15	H26S1015A0AA	T	2.50	5.88	14	2562	3200	171	213	15	0.14	1.11

Aerovox Corp.®

Type H High Voltage AC & DC Capacitors

Ratings - Oval Cases 90 °C

RoHS Compliant

Cap (μ F)	Catalog Part Number	Case Code	W Width (in)	L Length (in)	Case Height (in)	I_{RMS} (A)	I_{PEAK} (A)	I_s Surge (A)	DV/dt Rated (V/ μ s)	DV/dt Max. (V/ μ s)	ESR @ 60 Hz (mohm)	DF 1kHz (%)	Weight (lbs)
660 Vac (1200 Vdc) Oval 90 °C													
1	H91S6601A0AA	A	1.31	2.16	2.38	1.44	266	332	266	332	80	0.05	0.24
2	H91S6602A0AA	A	1.31	2.16	2.38	2.22	411	513	205	257	40	0.05	0.24
5	H91S6605A0AA	A	1.31	2.16	3.25	2.59	480	599	96	120	48	0.15	0.32
10	H92S6610A0AA	B	1.56	2.69	3.75	4.26	788	984	79	98	35	0.22	0.56
12	H92S6612A0AA	B	1.56	2.69	3.75	5.11	946	1181	79	98	29	0.22	0.56
15	H93S6615A0AA	C	1.91	2.91	3.75	6.39	1183	1477	79	98	24	0.23	0.68
20	H94S6620A0AA	D	1.97	3.66	3.25	10.37	1919	2397	96	120	14	0.18	0.85
25	H94S6625A0AA	D	1.97	3.66	3.75	10.65	1971	2461	79	98	16	0.25	0.97
30	H94S6630A0AA	D	1.97	3.66	4.25	10.84	2006	2506	67	84	15	0.29	1.08
35	H94S6635A0AA	D	1.97	3.66	4.75	10.99	2033	2539	58	73	18	0.4	1.19
40	H94S6640A0AA	D	1.97	3.66	5.88	10.02	1855	2316	46	58	24	0.59	1.44
45	H94S6645A0AA	D	1.97	3.66	5.88	11.28	2086	2606	46	58	21	0.6	1.44
750 Vac (1350 Vdc) Oval 90 °C													
1	H91S7501A0AA	A	1.31	2.16	2.38	1.44	266	332	266	332	80	0.05	0.24
2	H91S7502A0AA	A	1.31	2.16	2.38	2.22	411	513	205	257	40	0.05	0.24
5	H92S7505A0AA	B	1.56	2.69	2.75	3.97	735	918	147	184	32	0.1	0.42
10	H93S7510A0AA	C	1.91	2.91	3.75	5.07	938	1171	94	117	30	0.19	0.68
12	H94S7512A0AA	D	1.97	3.66	3.25	7.42	1374	1716	114	143	20	0.15	0.85
15	H94S7515A0AA	D	1.97	3.66	3.75	7.60	1406	1756	94	117	21	0.2	0.97
20	H94S7520A0AA	D	1.97	3.66	4.25	8.58	1587	1982	79	99	19	0.24	1.08
25	H94S7525A0AA	D	1.97	3.66	4.75	9.30	1720	2148	69	86	22	0.34	1.19
850 Vac (1500 Vdc) Oval 90 °C													
1	H91S8501A0AA	A	1.31	2.16	2.38	1.44	266	332	266	332	80	0.05	0.24
2	H92S8502A0AA	B	1.56	2.69	2.38	2.55	471	588	235	294	40	0.05	0.36
5	H93S8505A0AA	C	1.91	2.91	2.75	4.56	843	1053	169	211	29	0.09	0.51
10	H94S8510A0AA	D	1.97	3.66	3.25	7.10	1313	1640	131	164	21	0.13	0.85
12	H94S8512A0AA	D	1.97	3.66	3.75	6.97	1291	1612	108	134	24	0.18	0.97
15	H94S8515A0AA	D	1.97	3.66	4.25	7.38	1366	1706	91	114	22	0.21	1.08
18	H94S8518A0AA	D	1.97	3.66	4.75	7.68	1421	1775	79	99	26	0.29	1.19
1000 Vac (1750 Vdc) Oval 90 °C													
2	H91S1202A0AA	A	1.31	2.16	3.25	1.78	330	412	165	206	80	0.10	0.32
5	H93S1005A0AA	C	1.91	2.91	3.75	3.65	675	844	135	169	45	0.14	0.68
10	H94S1010A0AA	D	1.97	3.66	4.25	6.18	1144	1429	114	143	27	0.17	1.08
12	H94S1012A0AA	D	1.97	3.66	4.75	6.43	1190	1486	99	124	31	0.23	1.19
15	H94S1015A0AA	D	1.97	3.66	5.88	6.35	1175	1468	78	98	36	0.34	1.44
1200 Vac (2000 Vdc) Oval 90 °C													
2	H92S1202A0AA	B	1.56	2.69	3.75	1.76	325	406	163	203	88	0.11	0.56
5	H94S1205A0AA	D	1.97	3.66	3.75	4.40	814	1016	163	203	38	0.12	0.97

Aerovox Corp.®

Type H High Voltage AC & DC Capacitors

Ratings - Round 90 °C

RoHS Compliant

Cap (μ F)	Catalog Part Number	Case Code	Base Diameter (in)	Case Height (in)	I_{RMS} (A)	I_{PEAK} (A)	I_s Surge (A)	DV/dt Rated (V/ μ s)	DV/dt Max. (V/ μ s)	ESR @ 60 Hz (mohm)	DF 1kHz (%)	Weight (lbs)
660 Vac (1200 Vdc) Round 90 °C												
1	H73S6601A0AA	P	1.75	4.25	1.44	266	332	266	332	80	0.05	0.47
2	H73S6602A0AA	P	1.75	4.25	2.22	411	513	205	257	40	0.05	0.47
5	H73S6605A0AA	P	1.75	4.25	4.59	849	1060	170	212	26	0.08	0.47
10	H73S6610A0AA	P	1.75	4.25	9.17	1698	2120	170	212	16	0.10	0.47
12	H74S6612A0AA	S	2.00	4.25	11.01	2037	2544	170	212	13	0.10	0.57
15	H76S6615A0AA	T	2.50	4.25	13.76	2546	3180	170	212	12	0.11	0.86
20	H76S6620A0AA	T	2.50	5.88	13.25	2452	3062	123	153	15	0.19	1.11
25	H76S6625A0AA	T	2.50	5.88	15.00	3065	3828	123	153	13	0.21	1.11
30	H76S6630A0AA	T	2.50	5.88	15.00	3678	4594	123	153	12	0.23	1.11
750 Vac (1350 Vdc) Round 90 °C												
1	H73S7501A0AA	P	1.75	4.25	1.4	266	332	266	332	80	0.05	0.47
2	H73S7502A0AA	P	1.75	4.25	2.2	411	513	205	257	40	0.05	0.47
5	H73S7505A0AA	P	1.75	4.25	5.4	995	1243	199	249	22	0.07	0.47
10	H74S7510A0AA	S	2.00	4.25	5.1	938	1171	94	117	14	0.09	0.57
12	H76S7512A0AA	T	2.50	5.88	8.6	1584	1979	132	165	20	0.15	1.11
15	H76S7515A0AA	T	2.50	5.88	10.7	1980	2473	132	165	17	0.16	1.11
20	H76S7520A0AA	T	2.50	5.88	14.3	2640	3298	132	165	14	0.18	1.11
25	H76S7525A0AA	T	2.50	5.88	15.0	3300	4122	132	165	13	0.2	1.11
850 Vac (1500 Vdc) Round 90 °C												
1	H73S8501A0AA	P	1.75	4.25	1.4	266	332	266	332	80	0.05	0.47
2	H73S8502A0AA	P	1.75	4.25	2.5	471	588	235	294	40	0.05	0.47
5	H73S8505A0AA	P	1.75	4.25	6.4	1,178	1,471	236	294	22	0.07	0.47
10	H76S8510A0AA	T	2.5	5.88	8.2	1,514	1,891	151	189	22	0.14	1.11
12	H76S8512A0AA	T	2.5	5.88	9.8	1,817	2,269	151	189	20	0.15	1.11
15	H76S8515A0AA	T	2.5	5.88	12.3	2,272	2,837	151	189	17	0.16	1.11